

Final Groundwater Availability Model Report for the Rustler Aquifer

Prepared by

John E. Ewing, P.E.
Van A. Kelley, P.G.
Toya L. Jones, P.G.
Tingting Yan, EIT
Abhishek Singh, Ph.D., EIT
Dennis W. Powers, Ph.D., P.G., L.P.G.
Robert M. Holt, Ph.D
John M. Sharp, Ph.D., PH.G., P.G.

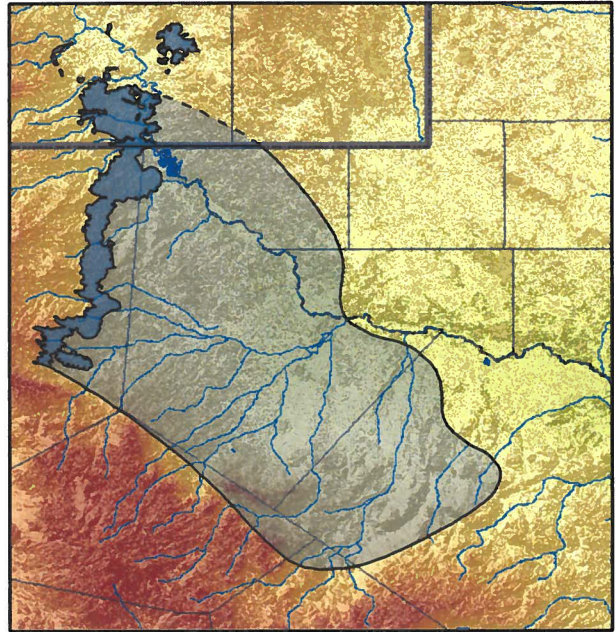

Prepared for:

Texas Water Development Board
P.O. Box 13231, Capitol Station
Austin, Texas 78711-3231



August 2012

2012 SEP -5 AM 7:16
-ADMINISTRATION

0904831000_Final Report

Final Groundwater Availability Model Report for the Rustler Aquifer

Prepared by

**John E. Ewing, P.E.
Van A. Kelley, P.G.
Toya L. Jones, P.G.
Tingting Yan, EIT
Abhishek Singh, Ph.D., EIT
Dennis W. Powers, Ph.D., P.G., L.P.G.
Robert M. Holt, Ph.D.
John M. Sharp, Ph.D., PH.G., P.G.**

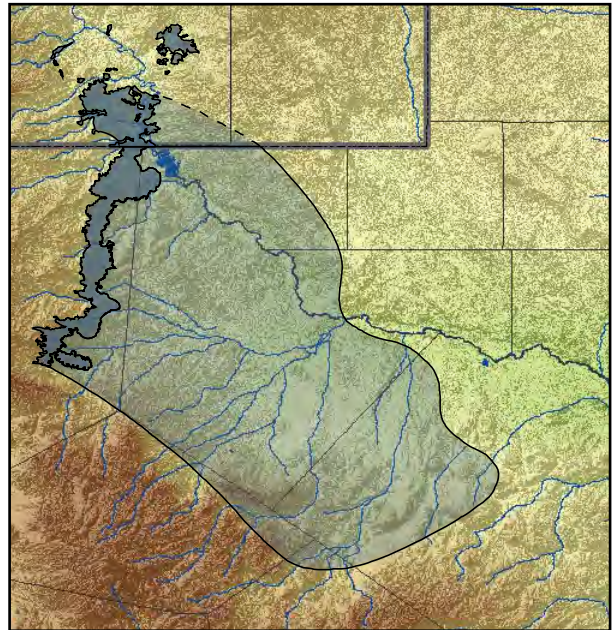

Prepared for:

**Texas Water Development Board
P.O. Box 13231, Capitol Station
Austin, Texas 78711-3231**



August 2012



Texas Water Development Board

**Final
Groundwater Availability Model Report
for the Rustler Aquifer**

by

John E. Ewing, P.E.

Van A. Kelley, P.G.

Toya L. Jones, P.G.

Tingting Yan, EIT

Abhishek Singh, Ph.D., EIT

INTERA Incorporated

Dennis W. Powers, Ph.D., P.G., L.P.G.

Dennis Powers Consulting

Robert M. Holt, Ph.D.

University of Mississippi

John M. Sharp, Jr., Ph.D., PH.G., P.G.

University of Texas at Austin

August 2012

This page is intentionally blank.

Geoscientist and Engineering Seal

This report documents the work of the following Licensed Texas Geoscientists and Licensed Texas Professional Engineer:

Van A. Kelley, P.G.,

Mr. Kelley was the Project Manager for this work and was responsible for oversight on the project and responsible for development of the conceptual model for the Rustler Aquifer.



Signature

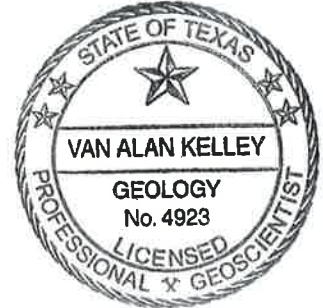

Date



John Ewing, P.E.,

Mr. Ewing was responsible for development and calibration of the Rustler Aquifer groundwater availability model.

Signature

Date



Toya L. Jones [Dale], P.G.,

Ms Jones assisted with development of the conceptual model for the Rustler Aquifer.

Signature

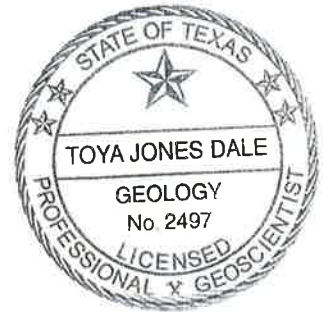

Date



Dennis W. Powers, Ph.D., P.G., L.P.G.,

Dr. Powers was responsible for the geology for the Rustler Aquifer and development of the Rustler Aquifer structure.

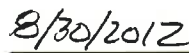
Signature

Date



This page intentionally left blank.

Table of Contents

Executive Summary xxi

1.0 Introduction 1-1

2.0 Study Area..... 2-1

 2.1 Physiography and Climate 2-13

 2.2 Geology..... 2-27

3.0 Previous Investigations 3-1

4.0 Hydrogeologic Setting..... 4-1

 4.1 Hydrostratigraphy 4-1

 4.1.1 Stratigraphy..... 4-1

 4.1.2 Rustler Sedimentology, Depositional Environments, and Post-
 Depositional Alteration 4-3

 4.2 Structure..... 4-7

 4.2.1 Rustler Formation Structure..... 4-7

 4.2.2 Dockum Aquifer and Dewey Lake Formation Structure 4-12

 4.2.3 Structural Character of the Rustler Formation..... 4-14

 4.2.4 Rustler Formation Structural Domains 4-17

 4.3 Water Levels and Regional Groundwater Flow 4-33

 4.3.1 Regional Groundwater Flow 4-34

 4.3.2 Pre-Development Conditions..... 4-36

 4.3.3 Water-Level Elevations for Transient Model Calibration 4-37

 4.3.4 Cross-Formational Flow 4-39

 4.3.5 Transient Water Levels 4-44

 4.4 Recharge 4-73

 4.4.1 Literature Estimates 4-75

 4.4.2 Estimation of Recharge..... 4-77

 4.4.3 Rejected Recharge 4-78

 4.5 Rivers, Streams, Springs, and Lakes 4-83

 4.5.1 Rivers and Streams 4-83

 4.5.2 Springs 4-85

 4.5.3 Lakes and Reservoirs 4-87

 4.6 Hydraulic Properties 4-97

 4.6.1 Data Sources 4-98

 4.6.2 Calculation of Hydraulic Conductivity from Specific Capacity 4-100

 4.6.3 Waste Isolation Pilot Plant Site Conceptual Model for Rustler
 Formation Transmissivity 4-101

 4.6.4 Spatial Conceptual Model for Transmissivity of the Rustler
 Formation..... 4-104

 4.6.5 Vertical Hydraulic Conductivity 4-107

 4.6.6 Storativity..... 4-107

 4.7 Discharge 4-119

 4.7.1 Natural Aquifer Discharge..... 4-119

Table of Contents, continued

4.7.2	Aquifer Discharge through Pumping.....	4-122
4.8	Water Quality in the Rustler Aquifer.....	4-145
4.8.1	Data Sources and Methods of Analysis	4-145
4.8.2	Drinking Water Quality	4-147
4.8.3	Irrigation Water Quality.....	4-151
5.0	Conceptual Model of Groundwater Flow in the Aquifer	5-1
6.0	Model Design	6-1
6.1	Code and Processor.....	6-1
6.2	Model Layers and Grid.....	6-3
6.3	Boundary Condition Implementation	6-7
6.3.1	Lateral Model Boundaries.....	6-8
6.3.2	Vertical Boundaries	6-9
6.3.3	Surface Water Implementation	6-11
6.3.4	Implementation of Recharge and Evapotranspiration.....	6-12
6.3.5	Implementation of Pumping Discharge	6-14
6.4	Model Hydraulic Parameters	6-29
6.4.1	Hydraulic Conductivity.....	6-29
6.4.2	Fault Conductance	6-30
6.4.3	Storage Coefficient	6-31
7.0	Modeling Approach.....	7-1
7.1	Calibration	7-1
7.2	Calibration Target Uncertainty	7-4
7.3	Conceptual Model Uncertainty.....	7-6
7.4	Sensitivity Analysis	7-8
8.0	Steady-State Model	8-1
8.1	Calibration	8-1
8.1.1	Calibration Targets.....	8-1
8.1.2	Horizontal and Vertical Hydraulic Conductivities	8-1
8.1.3	Recharge and Groundwater Evapotranspiration	8-2
8.1.4	General-Head Boundaries.....	8-3
8.1.5	Stream Conductances.....	8-3
8.2	Simulation Results.....	8-9
8.2.1	Water-Level Elevation.....	8-9
8.2.2	Streams, Springs, and Evapotranspiration	8-10
8.2.3	Cross-Formational Flow	8-12
8.2.4	Water Budget	8-12
8.3	Sensitivity Analysis	8-23
9.0	Transient Model	9-1
9.1	Calibration	9-1
9.1.1	Calibration Targets.....	9-1

Table of Contents, continued

9.1.2	Storage Parameters.....	9-2
9.1.3	Pumping.....	9-2
9.2	Simulation Results.....	9-7
9.2.1	Water-Level Elevations.....	9-7
9.2.2	Streams, Springs, and Evapotranspiration.....	9-9
9.2.3	Water Budget.....	9-9
9.3	Sensitivity Analysis.....	9-29
9.3.1	Sensitivity of Simulated Head to Changes in Conductivity.....	9-30
9.3.2	Sensitivity of Simulated Stream Gain to Changes in Conductivity.....	9-30
9.3.3	Sensitivity of Simulated Spring Flow to Changes in Conductivity.....	9-30
9.3.4	Sensitivity of Flowing Well Flow to Changes in Conductivity.....	9-31
9.3.5	Sensitivity of Hydrographs to Changes in Conductivity.....	9-31
9.3.6	Sensitivity of Hydrographs to Changes in Storage.....	9-32
9.3.7	Sensitivity of Hydrographs to Changes in Recharge.....	9-32
9.3.8	Sensitivity of Hydrographs to Changes in Lateral Inflow.....	9-32
9.3.9	Sensitivity of Hydrographs to Changes in Pumping.....	9-33
9.3.10	Sensitivity to Specific Underestimates in Pumping.....	9-33
9.3.11	Long-term Sensitivity to Vertical Hydraulic Conductivity.....	9-34
10.0	Limitations of the Model.....	10-1
10.1	Limitations of Supporting Data.....	10-1
10.2	Assessment of Assumptions.....	10-5
10.3	Limits for Model Applicability.....	10-6
11.0	Future Improvements.....	11-1
11.1	Additional Supporting Data.....	11-1
11.2	Future Model Implementation Improvements.....	11-2
11.3	Using the Model as a Predictive Tool.....	11-3
12.0	Conclusions.....	12-1
13.0	Acknowledgements.....	13-1
14.0	References.....	14-1
Appendix A	Sensitivity Analyses by Hydrostructural Domain	
Appendix B	Conceptual Model Report Comments and Responses	
Appendix C	Groundwater Availability Model Comments and Responses	
Appendix D	Final Groundwater Availability Model Comments and Responses	

Final Groundwater Availability Model for the Rustler Aquifer

This page is intentionally blank.

List of Figures

Figure 1.0.1 Locations of major aquifers in Texas (TWDB, 2006a). 1-4

Figure 1.0.2 Locations of minor aquifers in Texas (TWDB, 2006b). 1-5

Figure 2.0.1 Study area for the Rustler Aquifer groundwater availability model (GAM). 2-3

Figure 2.0.2 Rustler Aquifer boundaries in Texas as determined by the TWDB (TWDB, 2006b) and extrapolated into New Mexico. 2-4

Figure 2.0.3 Cities and major roadways in the study area. 2-5

Figure 2.0.4 Rivers, streams, lakes, and reservoirs in the study area. 2-6

Figure 2.0.5 Major aquifers in Texas intersecting the study area (TWDB, 2006a). 2-7

Figure 2.0.6 Minor aquifers in Texas intersecting the study area (TWDB, 2006b). 2-8

Figure 2.0.7 Texas Regional Water Planning Areas in the study area (TWDB, 2008). 2-9

Figure 2.0.8 Texas Groundwater Conservation Districts (GCDs) in the study area (TWDB 2010a). 2-10

Figure 2.0.9 Texas Groundwater Management Areas in the study area (TWDB, 2007b). 2-11

Figure 2.0.10 Major river basins in the study area (TWDB, 2010b). 2-12

Figure 2.1.1 Physiographic provinces in the study area (United States Geological Survey, 2002). 2-15

Figure 2.1.2 Level III ecological regions in the study area (United States Environmental Protection Agency, 2011). 2-16

Figure 2.1.3 Topographic map of the study area showing land surface elevation in feet above mean sea level (United States Geological Survey, 2010a). 2-17

Figure 2.1.4 Climate classifications in the Texas portion of the study area (Larkin and Bomar, 1983). 2-18

Figure 2.1.5 Average annual air temperature in degrees Fahrenheit for the Texas portion of the study area (Narasimhan and others, 2007). 2-19

Figure 2.1.6 Average annual precipitation in inches per year in the study area for the time period 1971 to 2001 (Oregon State University, 2002). 2-20

Figure 2.1.7 Location of precipitation gages in the study area (National Climatic Data Center, 2001). 2-21

Figure 2.1.8 Selected time series of annual precipitation in inches per year in the study area. (A discontinuous line indicates a break in the data. The dashed red line represents the mean annual precipitation.) (National Climatic Data Center, 2001). 2-22

Figure 2.1.9 Selected time series of average monthly precipitation in inches per month in the study area (National Climatic Data Center, 2001). 2-23

Figure 2.1.10 Average annual net pan evaporation rate in inches per year over the study area (TWDB, 2009a). 2-24

Figure 2.1.11 Average monthly lake surface evaporation in inches at selected locations in the study area (TWDB, 2009a). 2-25

Figure 2.2.1 Major structural features in the study area (after Armstrong and McMillion, 1961; Sharp and others, 2003). 2-33

List of Figures, continued

Figure 2.2.2 Generalized surface geology in the study area (United States Geological Survey – Texas Water Science Center and the Texas Natural Resource Information Center, 2004). 2-34

Figure 2.2.3 Generalized stratigraphic column for the Rustler Formation and overlying and underlying formations..... 2-35

Figure 2.2.4 A-A’ north-south cross-section extending from Lea County, New Mexico into Brewster County, Texas. 2-36

Figure 2.2.5 B-B’ east-west cross-section extending from the Rustler Aquifer outcrop in Culberson County into Crane County. 2-37

Figure 2.2.6 C-C’ southwest-northeast cross-section extending from the Glass Mountains into Ward County. 2-38

Figure 3.0.1 Troughs identified by Hiss (1976) and faults given in Armstrong and McMillion (1961) and Boghici (1997). 3-7

Figure 3.0.2 Locations of boundaries for previous modeling studies that considered the Rustler Formation (Corbet and Knupp, 1996; Boghici, 1997; Corbet, 2000; Harden, 2011)..... 3-8

Figure 4.2.1 Hand drawn contours of the elevation (in feet above mean sea level) of the top of the Rustler Formation..... 4-23

Figure 4.2.2 Hand drawn contours of the elevation (in feet above mean sea level) of the base of the Rustler Formation..... 4-24

Figure 4.2.3 Interpolated elevation (in feet above mean sea level) of the top of the Rustler Formation. 4-25

Figure 4.2.4 Interpolated elevation (in feet above mean sea level) of the bottom of the Rustler Formation. 4-26

Figure 4.2.5 Isopach of Rustler Formation thickness (in feet)..... 4-27

Figure 4.2.6 Elevation (in feet above mean sea level) of the top of the Dockum Aquifer..... 4-28

Figure 4.2.7 Elevation (in feet above mean sea level) of the top of the Dewey Lake Formation..... 4-29

Figure 4.2.8 Elevation (in feet above mean sea level) of the top of the combined Dockum Aquifer and Dewey Lake Formation. 4-30

Figure 4.2.9 Isopach of the combined Dockum Aquifer and Dewey Lake Formation thickness (in feet). 4-31

Figure 4.2.10 Structure domains in the Rustler Formation. 4-32

Figure 4.3.1 Water-level measurement locations for the Rustler Aquifer and Rustler Formation in Texas (TWDB, 2010c). 4-54

Figure 4.3.2 Temporal distribution of water-level measurements in the Rustler Aquifer and Rustler Formation (TWDB, 2010c)..... 4-55

Figure 4.3.3 Locations of Rustler Aquifer and Rustler Formation wells that once flowed (TWDB, 2010c). 4-56

Figure 4.3.4 Posted maximum water-level elevation (in feet above mean sea level), or ground surface elevation (in feet above mean sea level) for flowing wells, for wells completed into the Rustler Formation (Sharp and others, 2003; TWDB, 2010c)..... 4-57

List of Figures, continued

Figure 4.3.5 Estimated pre-development water-level elevations (in feet above mean sea level) for the Rustler Aquifer and Rustler Formation (TWDB, 2010c). 4-58

Figure 4.3.6 Estimated water-level elevations (in feet above mean sea level) in the Rustler Aquifer and Rustler Formation for January 1980 (Bowman, 2010; TWDB, 2010c)..... 4-59

Figure 4.3.7 Estimated water-level elevations (in feet above mean sea level) in the Rustler Aquifer and Rustler Formation for January 1990 (Bowman, 2010; TWDB, 2010c)..... 4-60

Figure 4.3.8 Estimated water-level elevations (in feet above mean sea level) in the Rustler Aquifer and Rustler Formation for December 1997 (Bowman, 2010; TWDB, 2010c)..... 4-61

Figure 4.3.9 Trend in water-level elevation in the Rustler Aquifer and Rustler Formation from 1980 to 1990 (Bowman, 2010; TWDB, 2010c). 4-62

Figure 4.3.10 Trend in water-level elevation in the Rustler Aquifer and Rustler Formation from 1990 to 1997 (Bowman, 2010; TWDB, 2010c). 4-63

Figure 4.3.11 Overall trend in water-level elevation in the Rustler Aquifer and Rustler Formation from 1980 to 1997 (Bowman, 2010; TWDB, 2010c). 4-64

Figure 4.3.12 Locations of aquifers overlying the Rustler Aquifer and locations of wells used for comparing water-level elevations between aquifers (TWDB, 2006a, 2006b, 2010c). 4-65

Figure 4.3.13 Comparison of water-level elevations (in feet above mean sea level) in the Rustler and Dockum aquifers (TWDB, 2006a, 2006b, 2010c). 4-66

Figure 4.3.14 Comparison of water-level elevations (in feet above mean sea level) in the Rustler and Edwards-Trinity (Plateau) aquifers (TWDB, 2006a, 2006b, 2010c)..... 4-67

Figure 4.3.15 Comparison of water-level elevations (in feet above mean sea level) in the Rustler and Pecos Valley aquifers (TWDB, 2006a, 2006b, 2010c). 4-68

Figure 4.3.16 Comparison of water-level elevations (in feet above mean sea level) in the Rustler Aquifer and the underlying Capitan Reef Complex Aquifer (TWDB, 2006b, 2010c)..... 4-69

Figure 4.3.17 Locations of Rustler Aquifer and Rustler Formation wells with transient water-level data (TWDB, 2010c)..... 4-70

Figure 4.3.18 Hydrographs of transient water-level data (in feet above mean sea level) for Rustler Aquifer wells in Culberson County and a Rustler Formation well in Crane County (TWDB, 2010c). 4-71

Figure 4.3.19 Hydrographs of transient water-level data (in feet above mean sea level) for Rustler Aquifer wells in Pecos and Reeves counties (TWDB, 2010c). 4-72

Figure 4.4.1 Rustler Aquifer outcrop regions (United States Geological Survey – Texas Water Science Center and the Texas Natural Resource Information Center, 2004; George and others, 2011). 4-80

List of Figures, continued

Figure 4.4.2	Basin and sub-basins in the Beach and others (2004) study area (from Beach and other, 2004).....	4-81
Figure 4.5.1	Location and flow duration curves (in cubic feet per second) for selected stream gages in the Rustler Aquifer outcrop (United States Geological Survey, 2010b).....	4-90
Figure 4.5.2	Example baseflow separation for United States Geological Survey gage 08407500 (United States Geological Survey, 2010b).....	4-91
Figure 4.5.3	Calculated gain based on hydrograph separation analysis (United States Geological Survey, 2010b).....	4-92
Figure 4.5.4	Locations of springs flowing from the Rustler Aquifer (Brune, 2002; Heitmuller and Reece, 2003; TWDB, 2010c).....	4-93
Figure 4.5.5	Hydrograph of discharge (in gallons per minute) from Diamond Y Springs (Brune, 2001; Heitmuller and Reece, 2003; TWDB, 2010c).....	4-94
Figure 4.5.6	Hydrograph of average monthly elevation for Red Bluff Reservoir (Red Bluff Water Power Control District, 2010).....	4-95
Figure 4.6.1	Available hydraulic property data for the Rustler Formation in Texas Myers, 1969; TWDB, 2010d).....	4-112
Figure 4.6.2	Measured transmissivity data from the Culebra Dolomite Member of the Rustler Formation in Eddy County, New Mexico (Beauheim, 2011a).....	4-113
Figure 4.6.3	Estimated hydraulic conductivity of the Culebra Dolomite Member of the Rustler Formation in Eddy County, New Mexico.....	4-114
Figure 4.6.4	Estimated hydraulic conductivity of the Culebra Dolomite Member of the Rustler Formation in Eddy County, New Mexico with estimated hydraulic conductivity calculated from specific capacity data for Rustler Formation wells in Texas (Myers, 1969; TWDB, 2010d).....	4-115
Figure 4.6.5	Thickness of overburden (in feet) above the Rustler Formation.....	4-116
Figure 4.6.6	Hydrostructural domains developed for the Rustler Formation (TWDB, 2010c).....	4-117
Figure 4.6.7	Conceptual relationship between hydrostructural subdomains and relative transmissivity of the Rustler Formation.....	4-118
Figure 4.7.1	Potential evapotranspiration (in inches per year) in the Rustler Aquifer outcrop region (Borrelli and others, 1998).....	4-137
Figure 4.7.2	Example of Texas GAP Analysis Project vegetation coverage near Cottonwood Creek in Culberson County, Texas (Parker and others, 2003).....	4-138
Figure 4.7.3	Rural population density in the Rustler Aquifer outcrop (TWDB, 2009b).....	4-139
Figure 4.7.4	Total pumpage (in acre-feet per year) for the Rustler Aquifer and Rustler Formation.....	4-140
Figure 4.7.5	Total groundwater withdrawals (in acre-feet per year) from the Rustler Formation in Crane County.....	4-140
Figure 4.7.6	Total groundwater withdrawals (in acre-feet per year) from the Rustler Aquifer in Culberson County.....	4-141

List of Figures, continued

Figure 4.7.7	Total groundwater withdrawals (in acre-feet per year) from the Rustler Aquifer in Pecos County.	4-141
Figure 4.7.8	Total groundwater withdrawals (in acre-feet per year) from the Rustler Aquifer in Reeves County.	4-142
Figure 4.7.9	Total groundwater withdrawals (in acre-feet per year) from the Rustler Formation in Ward County.	4-142
Figure 4.7.10	Total groundwater withdrawals (in acre-feet per year) from the Rustler Formation in Winkler County.	4-143
Figure 4.8.1	Piper diagram showing the chemical composition of groundwater in the Rustler Aquifer based on available water-chemistry data (TWDB, 2010c).	4-156
Figure 4.8.2	Total dissolved solids concentration (in milligrams per liter) in the Rustler Formation (Bowman, 2010; TWDB, 2010c).	4-157
Figure 4.8.3	Ground-water quality in the Rustler Aquifer based on total dissolved solids content (modified from Texas Water Commission, 1989).	4-158
Figure 4.8.4	Sulfate concentration (in milligrams per liter) in the Rustler Formation (Bowman, 2010; TWDB, 2010c).	4-159
Figure 4.8.5	Chloride concentration (in milligrams per liter) in the Rustler Formation (Bowman, 2010; TWDB, 2010c).	4-160
Figure 4.8.6	Nitrate concentration (in milligrams per liter as N) in the Rustler Formation (Bowman, 2010; TWDB, 2010c).	4-161
Figure 4.8.7	Fluoride concentration (in milligrams per liter) in the Rustler Formation (Bowman, 2010; TWDB, 2010c).	4-162
Figure 4.8.8	Alpha activity (in picocuries per liter) in the Rustler Formation (TWDB, 2010c).	4-163
Figure 4.8.9	Salinity hazard in the Rustler Formation (Bowman, 2010; TWDB, 2010c).	4-164
Figure 4.8.10	Sodium hazard in the Rustler Formation (TWDB, 2010c).	4-165
Figure 5.0.1	Conceptual diagram of the proposed flow systems in the Rustler Aquifer.	5-9
Figure 5.0.2	Conceptual groundwater flow model (cross-sectional view) for the Rustler Aquifer GAM.	5-10
Figure 6.2.1	Active model area and model grid at the county scale for the Rustler Aquifer GAM.	6-5
Figure 6.3.1	Boundary zones for the Rustler Aquifer GAM.	6-18
Figure 6.3.2	Layer 1 boundary conditions and active/inactive cells.	6-19
Figure 6.3.3	Layer 2 boundary conditions and active/inactive cells.	6-20
Figure 6.3.4	Head data used to develop the general head boundary heads for layer 1.	6-21
Figure 6.3.5	Layer 1 general-head boundary heads.	6-22
Figure 6.3.6	General-head boundary head adjustment to simulated drawdown in the Edwards-Trinity (Plateau) and Pecos Valley aquifers based on observed water levels.	6-23
Figure 6.3.7	Recharge distribution in inches per year.	6-24

List of Figures, continued

Figure 6.3.8 Temporal pumping distribution in acre-feet per year for the entire Rustler Aquifer and by subdomain. 6-25

Figure 6.3.9 Pumping distribution in acre-feet per year for the Rustler Aquifer in 1980. 6-26

Figure 6.3.10 Pumping distribution in acre-feet per year for the Rustler Aquifer in 1990. 6-27

Figure 6.3.11 Pumping distribution in acre-feet per year for the Rustler Aquifer in 2000. 6-28

Figure 6.4.1 Layer 1 horizontal hydraulic conductivity (Kh) in feet per day. 6-32

Figure 6.4.2 Layer 2 horizontal hydraulic conductivity (Kh) in feet per day. 6-33

Figure 6.4.3 Layer 2 transmissivity in feet squared per day. 6-34

Figure 6.4.4 Layer 1 vertical hydraulic conductivity (Kv) in feet per day. 6-35

Figure 6.4.5 Layer 2 vertical hydraulic conductivity (Kv) in feet per day. 6-36

Figure 6.4.6 Layer 2 horizontal flow barrier (HFB) conductances. 6-37

Figure 6.4.7 Layer 1 storativity. 6-38

Figure 6.4.8 Layer 2 storativity. 6-39

Figure 8.1.1 Calibrated horizontal hydraulic conductivity (Kh) in feet per day for the Rustler Aquifer. 8-5

Figure 8.1.2 Calibrated transmissivity in feet squared per day for the Rustler Aquifer. 8-6

Figure 8.1.3 Calibrated vertical hydraulic conductivity (Kv) in feet per day for the Rustler Aquifer. 8-7

Figure 8.2.1 Plots of (a) simulated versus observed water-level elevations in feet and (b) residual versus observed water-level elevation in feet for the Rustler Aquifer in the steady-state model by hydrostructural subdomain. 8-15

Figure 8.2.2 Simulated steady-state water levels and residuals in feet for the Rustler Aquifer. 8-16

Figure 8.2.3 Steady-state model stream gain/loss in acre-feet per year (negative values denote gaining streams). 8-17

Figure 8.2.4 Simulated spring flow rates in acre-feet per year in the steady-state model. 8-18

Figure 8.2.5 Simulated head in relation to land-surface elevation at springs and flowing wells in the steady-state model. 8-19

Figure 8.2.6 Simulated evapotranspiration discharge in acre-feet per year for the steady-state model. 8-20

Figure 8.2.7 Simulated cross-formational flow to overlying aquifers in acre-ft per year (positive value denotes flow from the Rustler Aquifer). 8-21

Figure 8.3.1 Steady-state head sensitivity in feet of the Rustler Aquifer to changes in hydraulic conductivities. 8-26

Figure 8.3.2 Steady-state head sensitivity in feet of the Rustler Aquifer to changes in boundary condition flows and conductances. 8-26

Figure 8.3.3 Steady-state head sensitivity in feet of the Rustler Aquifer to changes in boundary condition elevations. 8-27

List of Figures, continued

Figure 8.3.4 Steady-state stream gain/loss sensitivity in acre-feet per year to changes in hydraulic conductivities. 8-27

Figure 8.3.5 Steady-state stream gain/loss sensitivity in acre-feet per year to changes in boundary condition flows and conductances. 8-28

Figure 8.3.6 Steady-state stream gain/loss sensitivity in acre-feet per year to changes in boundary condition elevations. 8-28

Figure 8.3.7 Steady-state spring flow sensitivity in acre-feet per year to changes in hydraulic conductivities. 8-29

Figure 8.3.8 Steady-state spring flow sensitivity in acre-feet per year to changes in boundary condition flows and conductances. 8-29

Figure 8.3.9 Steady-state spring flow sensitivity in acre-feet per year to changes in boundary condition elevations. 8-30

Figure 9.1.1 Calibrated storativity for the Rustler Aquifer. Note that the value of 0.15 represents specific yield in the outcrop. 9-4

Figure 9.1.2 Adjusted pumping for the entire Rustler Aquifer and by hydrostructural subdomain. 9-5

Figure 9.2.1 Adjusted mean absolute error in feet over time. 9-16

Figure 9.2.2 Plots of (a) simulated versus observed water-level elevations in feet and (b) residual versus observed water-level elevation in feet for the Rustler Aquifer by subdomain during the transient model calibration period (1939 through 2008). 9-17

Figure 9.2.3 Average residuals in feet at target wells for the Rustler Aquifer during the entire transient model calibration (1939 through 2008). 9-18

Figure 9.2.4 Simulated water levels and residuals in feet at target wells for the Rustler Aquifer in 1959. 9-19

Figure 9.2.5 Simulated water levels and residuals in feet at target wells for the Rustler Aquifer for 1970. 9-20

Figure 9.2.6 Simulated water levels and residuals in feet at target wells for the Rustler Aquifer for 1988. 9-21

Figure 9.2.7 Simulated water levels and residuals in feet at target wells for the Rustler Aquifer for 2008. 9-22

Figure 9.2.8 Hydrographs of simulated (lines) and measured (points) water-level elevations in feet in the Rustler Aquifer. 9-23

Figure 9.2.9 Simulated stream gain/loss in acre-feet per year for 2008 (negative value indicates gaining stream cell). 9-24

Figure 9.2.10 Simulated spring flow and simulated flow from flowing wells in acre-feet per year for the transient model in 2008. 9-25

Figure 9.2.11 Simulated and observed discharge at Diamond Y Springs in acre-feet per year for the transient model. 9-26

Figure 9.2.12 Simulated evapotranspiration in acre-feet per year for the transient model in 2008. 9-27

Figure 9.2.13 Time history of water budget in acre-feet per year for the Rustler Aquifer. Positive values denote recharge and negative values denote discharge. 9-28

List of Figures, continued

Figure 9.3.1 Transient sensitivity of heads in feet to changes in hydraulic conductivities. 9-37

Figure 9.3.2 Transient sensitivity of heads in feet to changes in storage parameters. 9-37

Figure 9.3.3 Transient sensitivity of heads in feet to changes in boundary condition flows and conductances. 9-38

Figure 9.3.4 Transient sensitivity of heads in feet to changes in boundary condition elevations. 9-38

Figure 9.3.5 Transient sensitivity of stream gain/loss in acre-feet per year to changes in hydraulic conductivities. 9-39

Figure 9.3.6 Transient sensitivity of stream gain/loss in acre-feet per year to changes in storage parameters. 9-39

Figure 9.3.7 Transient sensitivity of stream gain/loss in acre-feet per year to changes in boundary condition flows and conductances. 9-40

Figure 9.3.8 Transient sensitivity of stream gain/loss in acre-feet per year to changes in boundary condition elevations. 9-40

Figure 9.3.9 Transient sensitivity of spring flow in acre-feet per year to changes in hydraulic conductivities. 9-41

Figure 9.3.10 Transient sensitivity of spring flow in acre-feet per year to changes in storage parameters. 9-41

Figure 9.3.11 Transient sensitivity of spring flow in acre-feet per year to changes in boundary condition flows and conductances. 9-42

Figure 9.3.12 Transient sensitivity of spring flow in acre-feet per year to changes in boundary condition elevations. 9-42

Figure 9.3.13 Transient sensitivity of flowing well flow in acre-feet per year to changes in hydraulic conductivities. 9-43

Figure 9.3.14 Transient sensitivity of flowing well flow in acre-feet per year to changes in storage parameters. 9-43

Figure 9.3.15 Transient sensitivity of flowing well flow in acre-feet per year to changes in boundary condition flows and conductances. 9-44

Figure 9.3.16 Transient sensitivity of flowing well flow in acre-feet per year to changes in boundary condition elevations. 9-44

Figure 9.3.17 Transient sensitivity hydrographs of head in feet where the horizontal hydraulic conductivity of the Rustler Aquifer is varied. 9-45

Figure 9.3.18 Transient sensitivity hydrographs of head in feet where the storage parameter is varied. 9-46

Figure 9.3.19 Transient sensitivity hydrographs of head in feet where recharge in the outcrop is varied. 9-47

Figure 9.3.20 Transient sensitivity hydrographs of head in feet where the lateral inflow from the Glass and Davis mountains is varied. 9-48

Figure 9.3.21 Transient sensitivity hydrographs of head in feet where pumping is varied. 9-49

Figure 9.3.22 Sensitivity of vertical gradient to 150 gpm pumping at three wells. 9-50

Figure 9.3.23 Long-term sensitivity to vertical hydraulic conductivity. 9-51

List of Tables

Table 4.1.1	Stratigraphy for the Rustler Formation across the study area.....	4-6
Table 4.3.1	Wells not considered to be completed into the Rustler Formation.....	4-46
Table 4.3.2	Number of wells with water-level data and number of water-level measurements for wells completed into the Rustler Aquifer or Rustler Formation.	4-47
Table 4.3.3	Number of wells completed into the Rustler Aquifer or Rustler Formation by decade.....	4-47
Table 4.3.4	Pre-development water-level elevations for the Rustler Aquifer and Rustler Formation.	4-48
Table 4.3.5	Comparison of average 1980, 1990, and 1997 water-level elevations.	4-49
Table 4.3.6	Summary of water-level data for wells completed into the Rustler Aquifer or Rustler Formation.	4-51
Table 4.4.1	Summary of recharge estimates in Beach and others (2004).....	4-79
Table 4.4.2	Characteristics of potential Rustler Aquifer recharge areas.	4-79
Table 4.4.3	Potential recharge as a percent of annual average precipitation for a range of assumed recharge factors expressed as a percent of annual precipitation.	4-79
Table 4.5.1	Annual gain/loss between selected gages from 1952 to 2009.	4-88
Table 4.5.2	Summary of spring flows from the Rustler Aquifer.....	4-89
Table 4.6.1	Rustler Formation specific capacity and transmissivity data in Texas.....	4-109
Table 4.6.2	Summary of controls on transmissivity and observed transmissivity ranges for hydrostructural subdomains.....	4-110
Table 4.6.3	Summary of literature estimates of storage for the Culebra Dolomite Member of the Rustler Formation.	4-111
Table 4.7.1	Estimates of vegetation coefficient and rooting depth for several vegetation types in the study area (from Scanlon and others, 2005).	4-127
Table 4.7.2	Irrigation pumpage (in acre-feet per year) from the Rustler Aquifer and Rustler Formation by county.....	4-127
Table 4.7.3	Livestock pumpage (in acre-feet per year) from the Rustler Aquifer and Rustler Formation by county.....	4-129
Table 4.7.4	Rural domestic pumpage (in acre-feet per year) from the Rustler Aquifer and Rustler Formation by county.	4-131
Table 4.7.5	Mining pumpage (in acre-feet per year) from the Rustler Aquifer and Rustler Formation by county.	4-133
Table 4.7.6	Total pumpage (in acre-feet per year) from the Rustler Aquifer and Rustler Formation by county.	4-134
Table 4.8.1	Number of wells with water-quality data by source type.	4-153
Table 4.8.2	Occurrence and levels of some commonly measured groundwater quality constituents in the Rustler Formation.	4-154
Table 4.8.3	Occurrence and levels of some commonly measured groundwater quality constituents in the Rustler Aquifer.	4-155
Table 8.2.1	Calibration statistics for the steady-state model.	8-13
Table 8.2.2	Water budget for the steady-state model (all rates reported in acre- feet per year).	8-13

Final Groundwater Availability Model for the Rustler Aquifer

Table 8.2.3	Water budget for the steady-state model with values expressed as a percentage of total inflow.	8-13
Table 8.2.4	Steady-state water budget in the Rustler Aquifer by county (all rates reported in acre-feet per year).....	8-13
Table 8.2.5	Steady-state water budget in the Rustler Aquifer by Groundwater Conservation District (all rates reported in acre-feet per year).	8-14
Table 9.1.1	Calibrated hydraulic properties in the Rustler Aquifer GAM.	9-3
Table 9.2.1	Calibration statistics for the entire transient calibration period (1939 through 2008).....	9-12
Table 9.2.2	Water budget for the transient model (all rates reported in acre-feet per year).	9-13
Table 9.2.3	Water budget for the transient model expressed as a percentage of total inflow.....	9-14
Table 9.2.4	Water budget in the Rustler Aquifer by county for 2008 (all rates reported in acre-feet per year).....	9-15
Table 9.2.5	Water budget in the Rustler Aquifer by Groundwater Conservation District for 2008 (all rates reported in acre-feet per year).	9-15
Table 9.3.1	Sensitivity of calibration statistics to vertical hydraulic conductivity of Dockum.	9-36

Acronyms

BRACS	Brackish Resources Aquifer Characterization System
GAM	groundwater availability model
TCEQ	Texas Commission on Environmental Quality
TWDB	Texas Water Development Board
WIPP	Waste Isolation Pilot Plant

Final Groundwater Availability Model for the Rustler Aquifer

This page intentionally left blank.

Executive Summary

This report documents the development of a three-dimensional groundwater model for the Rustler Aquifer. The Rustler Aquifer, a minor aquifer in Texas, consists of the portion of the Rustler Formation containing groundwater with a total dissolved solids concentration of less than 5,000 milligrams per liter. The Rustler Aquifer is located in the Trans-Pecos area of west Texas and southern New Mexico. In Texas, the aquifer crops out in Culberson County and occurs in subcrop under Reeves County and portions of Loving, Ward, Pecos, Jeff Davis, and Brewster counties. In New Mexico, the aquifer crops out in southern Eddy County and occurs in subcrop under southeastern Eddy County and the very southwestern corner of Lea County. The Rustler Formation extends farther east and northeast in Texas and farther north in New Mexico. However, those portions of the formation are not considered to be part of the aquifer by the Texas Water Development Board (TWDB) because of poor water quality and low permeability.

Groundwater occurs in partly dissolved dolomite, limestone, and gypsum, and most of the water production comes from fractures and solution openings in the upper part of the Rustler Formation. The water is used primarily for irrigation, livestock, and water-flooding operations in oil-producing areas. The only significant water-level declines in the aquifer that are well supported by long-term hydrographs occur in the Belding area of Pecos County where the aquifer has historically been used in agriculture.

The Rustler Aquifer groundwater availability model (GAM) was developed using the groundwater simulation code MODFLOW-NWT. The model consists of a lower layer representing the Rustler Aquifer and an upper layer representing the overlying Dewey Lake Formation and Dockum Group. The purpose of the upper layer is to provide a means of incorporating the significant vertical resistance and storage that exists (in most places) between the Rustler Aquifer and the Edwards-Trinity (Plateau) and Pecos Valley aquifers. In addition, the upper layer and the supporting structure provide needed information as the TWDB works towards developing a multi-aquifer GAM in the groundwater management area.

MODFLOW-NWT requires a rectilinear grid. Typically, one axis of the model grid is aligned parallel to the primary direction of flow. Because of the somewhat compartmentalized and

separate flow systems, the Rustler Aquifer has no primary flow direction. For simplicity, the Rustler Aquifer GAM grid was aligned with the primary directions in the GAM projected coordinate system. The grid cells are quarter-mile by quarter-mile squares throughout the model domain. The model grid origin (lower left) is located at GAM coordinates 19,438,000 feet north and 3,550,550 feet east with the x-axis oriented east-west. The model has 466 columns and 526 rows for a total of 245,116 grid cells per layer. Not all of these grid cells are active in the model. After clipping the layers to their proper dimensions, model layers 1 and 2 have 109,167 and 117,073 active grid cells, respectively. The total number of active grid cells in the model is 226,240.

There is a general lack of hydrogeologic data for the Rustler Aquifer in Texas; however, the data available provide evidence for significant variability in the aquifer properties resulting from structural complexity within the basin, variability in lithology, and the effects of post-depositional processes. As a result of this complexity, parameterization of the Rustler Aquifer GAM relied heavily on conceptual models provided in Section 4.0 of this report while trying to honor the sparse property data available. The model incorporates the available information on structure, hydrostratigraphy, hydraulic properties, streamflow, recharge, evapotranspiration, and pumping for the Rustler Aquifer. The underlying data for these parameters are presented and discussed in detail in this report.

Perhaps one of the most important contributions of this work is the development of a detailed structure for the Rustler Aquifer and Rustler Formation. The structure for the Rustler Aquifer GAM was developed in coordination with development of structure for the Trans-Pecos area in west Texas by the TWDB Brackish Resources Aquifer Characterization System (BRACS) division as part of their pilot program to evaluate brackish groundwater systems. The primary source of data for identifying the structural top and bottom of the Rustler Formation came from geophysical logs obtained from sources including, but not limited to, the BRACS, the TWDB's Capitan Aquifer structure project, and the New Mexico Oil Conservation Division. The resulting structure identified numerous faults within the Rustler Formation. Significant vertical displacement across some of these faults divides the aquifer, in some areas, into relatively isolated flow domains.

The modeling used the industry-standard approach that has been accepted and standardized in the TWDB groundwater availability requirements. This standard approach includes model calibration and model sensitivity analysis. In the context of groundwater modeling, model calibration can be defined as the process of producing an agreement between model simulated water levels and aquifer discharge, and field measured water levels and aquifer discharge through the adjustment of independent variables. Because the steady-state and transient models are combined within a single model, changes to the model made during calibration were propagated to both the steady-state and transient models. The generally accepted practice for groundwater calibration includes performance of a sensitivity analysis, which was performed as part of the groundwater availability model calibration. A sensitivity analysis entails the systematic variation of the calibrated parameters and stresses with re-simulation of aquifer conditions. Those parameters that strongly change the simulated aquifer water levels and discharges are important parameters to the calibration.

The model was calibrated for two time periods, one representing steady-state conditions and the other representing transient conditions. The steady-state calibration considers a “predevelopment” time period prior to extensive aquifer development. The transient calibration period ran from 1919 through 2008 to include as many water-level observations as possible and to incorporate the historical period of greatest groundwater development in the 1960s and 1970s. Pumping estimates based upon historical records were applied on an annual basis in the transient calibration period. Recharge and stream stage remain constant throughout the transient period.

The model was calibrated through a wide range of hydrological conditions. The steady-state model represents a period of equilibrium where aquifer recharge and aquifer discharge are in balance. The transient calibration period (1919 through 2008) represents a time of transient aquifer behavior. The transient calibration period also helps to constrain the model parameterization because a wider range of hydrologic conditions are encountered and simulated. The sensitivity of the transient model to certain parameters differs from that of the steady-state model.

Both the steady-state and transient calibrations adequately reproduced aquifer water levels and were within the uncertainty in the water-level estimates. In addition, the model performs well in

the historical period before 1980 for the limited head data available for comparison. In a few local areas in and around Belding in Pecos County, good evidence of significant drawdowns is present in the hydrographs. The model performs well in matching those drawdowns. The most important discharge target available for the Rustler Aquifer is the Diamond Y Springs system located in Pecos County. The model does a very good job of calibrating the magnitudes and general trend in decreasing spring flow levels from the earliest measurements in the early 1940s through to the latest records in the 1990s.

For both the steady-state and transient models, direct recharge in the outcrop of Culberson County comprised approximately 55 percent of total inflow to the aquifer. The remainder of model inflow occurs through lateral flow that originates largely from the Glass Mountains and to a lesser degree from the Davis and Apache mountains. Total inflow in the model in steady-state is approximately 7,133 acre feet per year. Discharge in the steady-state model is predominantly through cross-formational flow (66 percent of outflows) followed by springs and evapotranspiration, 16 and 14 percent of outflows, respectively. The most sensitive parameter in the steady-state model is the horizontal hydraulic conductivity of the Rustler Aquifer.

The transient model differs from the steady-state model in the amount of net inflow through storage due to development of the Rustler Aquifer and indirectly from development within the Edwards-Trinity (Plateau) and Pecos Valley aquifers as implemented through the general-head boundaries in layer 1. A maximum release from storage into the Rustler Aquifer of 8,395 acre-feet per year occurs in 1971. The large releases from storage during this period compared to the recharge inflow into the aquifer in that area of the aquifer suggest that the 1971 level of pumping is unsustainable.

The purpose of the Rustler Aquifer GAM is to provide a calibrated numerical model that can be used to estimate modeled available groundwater, support the regional planning process and to assess the effects of various proposed water management strategies on the aquifer system. The applicability of the Rustler Aquifer model is limited to regional-scale assessments of groundwater availability (e.g., an area smaller than a county and larger than a one sixteenth of a square mile) because of the relatively large grid blocks (one sixteenth of a square mile) over which pumping and hydraulic property data are averaged. At the scale of the model, predicting

aquifer responses at a specific point, such as a particular well, is not feasible. Because of uncertainty in pumping and hydraulic property data, the model is limited to a first-order approach of coupling flows between major aquifers overlying the Rustler Aquifer and the Dewey Lake Formation and Dockum Group. Finally, the model is limited in that it does not address the potential for cross-formational flow between the Rustler Aquifer and the underlying units, most importantly, the Capitan Reef Complex Aquifer.

The Rustler Aquifer GAM provides a documented, publicly-available, integrated tool for use by state planners, Regional Water Planning Groups, Groundwater Conservation Districts, Groundwater Management Areas, and other interested stakeholders.

This page intentionally left blank.

1.0 Introduction

The Texas Water Development Board (TWDB) has identified the major and minor aquifers in Texas on the basis of regional extent and amount of water produced. The major and minor aquifers are shown in Figures 1.0.1 and 1.0.2, respectively. General discussion of the major and minor aquifers is given in George and others (2011). Aquifers that supply large quantities of water over large areas of the state are defined as major aquifers and those that supply relatively small quantities of water over large areas of the state or supply large quantities of water over small areas of the state are defined as minor aquifers.

The Rustler Aquifer, a minor aquifer in Texas (see Figure 1.0.2), consists of the portion of the Rustler Formation containing groundwater with a total dissolved solids concentration of less than 5,000 milligrams per liter (Boghici and Van Broekhoven, 2001). The Rustler Aquifer is located in the Trans-Pecos area of west Texas and southern New Mexico. In Texas, the aquifer crops out in Culberson County and occurs in subcrop under Reeves County and portions of Loving, Ward, Pecos, Jeff Davis, and Brewster counties (George and others, 2011). In New Mexico, the aquifer crops out in southern Eddy County and occurs in subcrop under southeastern Eddy County and the very southwestern corner of Lea County. The Rustler Formation extends farther east and northeast in Texas and farther north in New Mexico. However, those portions of the formation are not considered to be part of the aquifer because of the poor water quality and less permeable conditions.

This report documents the development of a groundwater availability model (GAM) for the Rustler Aquifer. Sections 1 through 5 document development of the conceptual model for the Rustler Aquifer. All aspects of the numerical model are discussed in Sections 6 through 9. Section 10 discusses limitations of the model, Section 11 provides suggestions for future improvements to the model, and Section 12 presents conclusions.

The quality of groundwater in the Rustler Aquifer is poor, varying from fresh in only a small area in the southern portion of the outcrop to brackish in most of the outcrop area and all of the downdip area. Groundwater from the Rustler Aquifer is used for irrigation and livestock

purposes. Groundwater from the Rustler Formation downdip of the aquifer delineation is also used for secondary oil recovery.

The 2012 State Water Plan (TWDB, 2012) identifies the existing groundwater supply in the Rustler Aquifer as 2,469 acre-feet per year with a total availability estimated at 2,492 acre-feet per year. Planning groups did not propose water management strategies for the Rustler Aquifer in the 2012 State Water Plan.

The GAM consists of a lower layer representing the Rustler Aquifer and an upper layer representing the overlying Dewey Lake Formation and Dockum Group. The purpose of the upper layer is to provide a means of incorporating the significant vertical resistance and storage that exists (in most places) between the Rustler Aquifer and the Edwards-Trinity (Plateau) and Pecos Valley aquifers. The upper layer also provides a means for the MODFLOW grid to address significant throw along faults or dissolution features. Finally, the upper layer and the supporting structure provide needed information as the TWDB works towards developing a multi-aquifer GAM in the groundwater management area.

The Texas Water Code codified the requirement for generation of a State Water Plan that allows for the development, management, and conservation of water resources and the preparation and response to drought, while maintaining sufficient water available for the citizens of Texas (TWDB, 2007a). Senate Bill 1 and subsequent legislation directed the TWDB to coordinate regional water planning with a process based upon public participation.

Groundwater models provide a tool to estimate groundwater availability for various water use strategies and to determine the cumulative effects of increased water use and drought. A groundwater model is a numerical representation of the aquifer system capable of simulating historical conditions and predicting future aquifer conditions. Inherent to the groundwater model are a set of equations that are developed and applied to describe the primary or dominant physical processes considered to be controlling groundwater flow in the aquifer system. Groundwater models are essential to performing complex analyses and in making informed predictions and related decisions (Anderson and Woessner, 1992).

Final Groundwater Availability Model for the Rustler Aquifer

Development of GAMs for the major and minor Texas aquifers is integral to the state water planning process. The purpose of the GAM program is to provide a tool that can be used to develop reliable and timely information on groundwater availability for the citizens of Texas and to ensure adequate supplies or recognize inadequate supplies over a 50-year planning period. The GAMs also serve as an integral part of the process of determining managed available groundwater based on desired future conditions, as required by House Bill 1763 passed in 2005 by the 79th Legislature. Managed available groundwater was later redefined in Senate Bill 737 passed in 2011 by the 82nd Legislature as modeled available groundwater. Modeled available groundwater is the amount of groundwater that can be produced on an average annual basis to achieve a desired future condition as established by the groundwater conservation districts located within 16 groundwater management areas within Texas.

The GAM for the Rustler Aquifer was developed using a modeling protocol that is standard to the groundwater modeling industry. This protocol includes: (1) the development of a conceptual model for groundwater flow in the aquifer, including defining physical limits and properties, (2) model design, (3) model calibration, (4) sensitivity analysis, and (5) reporting. The conceptual model is a description of the physical processes governing groundwater flow in the aquifer system. Available data and reports for the model area were reviewed in the conceptual model development stage. Model design is the process used to translate the conceptual model into a physical model, which in this case is a numerical model of groundwater flow. This involves organizing and distributing model parameters, developing a model grid and model boundary conditions, and determining the model integration time scale. Model calibration is the process of modifying model parameters so that observed field measurements (e.g., water levels in wells) can be reproduced. The model was calibrated to pre-development conditions representing, as closely as possible, conditions in the aquifer prior to significant development and to transient aquifer conditions. Sensitivity analyses were performed on both the pre-development and transient models to offer insight on the uniqueness of the model and the impact of uncertainty in model parameter estimates.

Final Groundwater Availability Model for the Rustler Aquifer

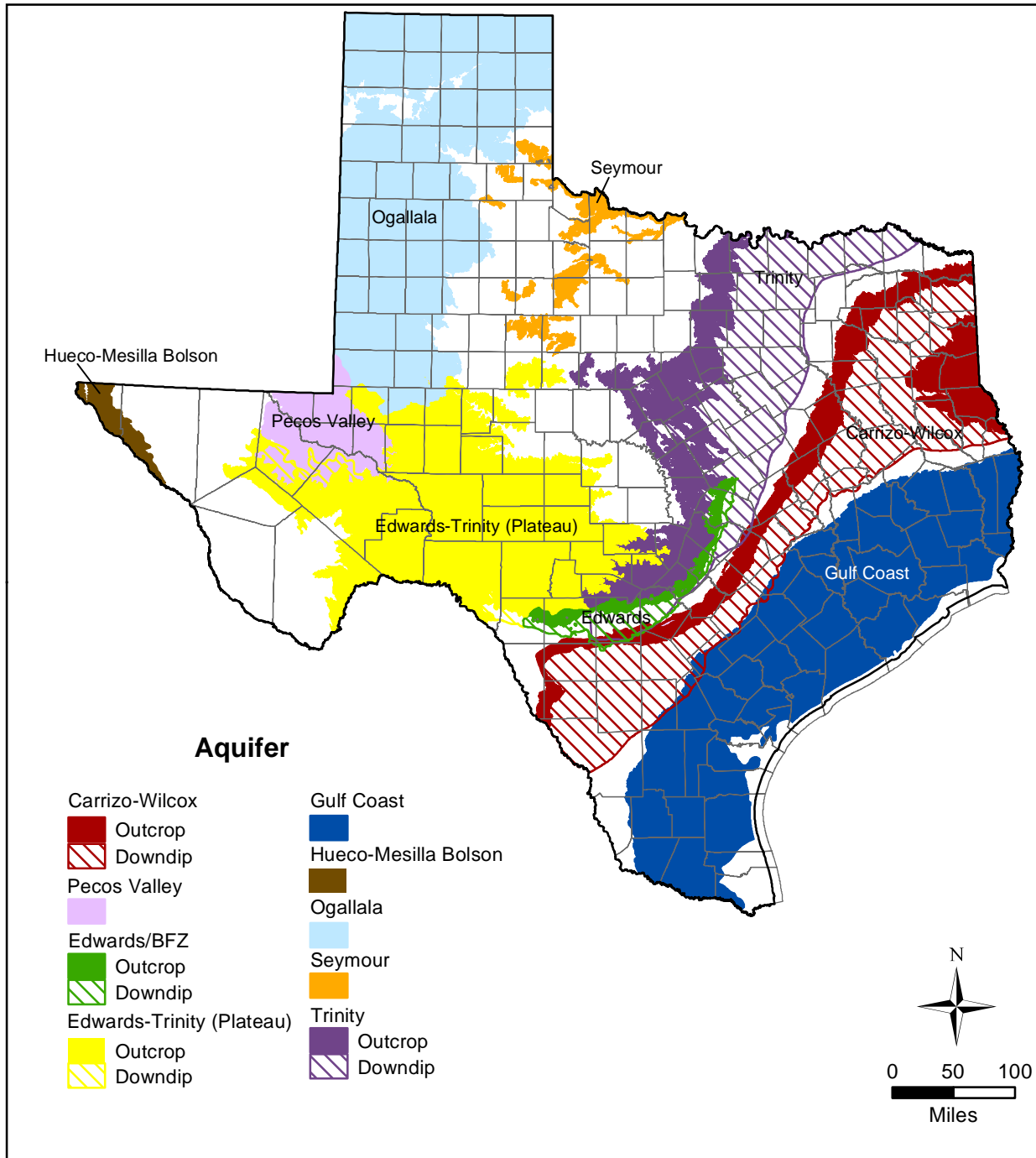

BFZ = Balcones Fault Zone

Figure 1.0.1 Locations of major aquifers in Texas (TWDB, 2006a).

Final Groundwater Availability Model for the Rustler Aquifer

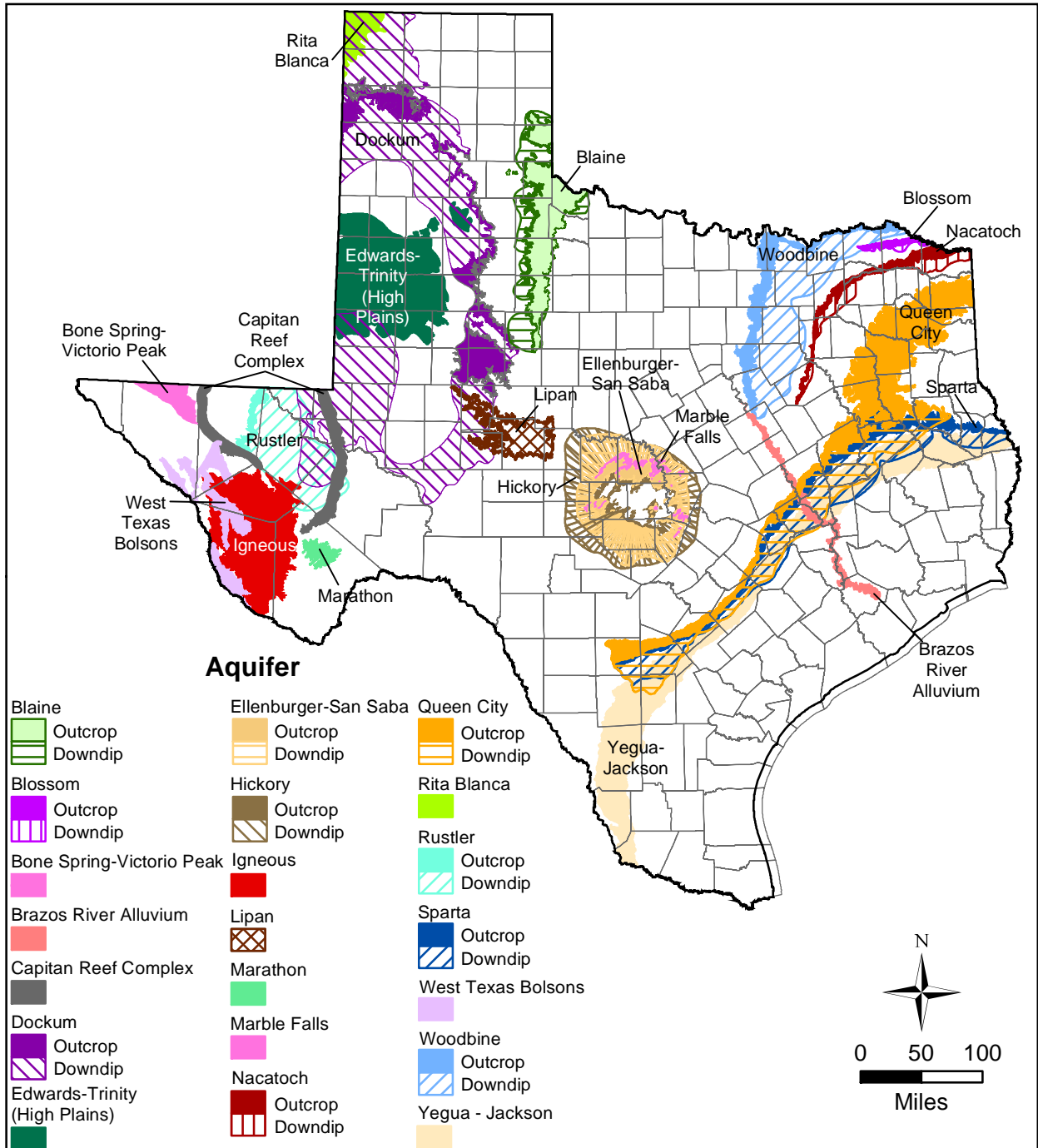

Figure 1.0.2 Locations of minor aquifers in Texas (TWDB, 2006b).

Final Groundwater Availability Model for the Rustler Aquifer

This page intentionally left blank.

2.0 Study Area

The Rustler Aquifer exists in the outcrop and portions of the subcrop of the Rustler Formation in the Trans-Pecos area of west Texas. In Texas, the Rustler Formation outcrop exists in a relatively narrow band oriented approximately north-south and located slightly west of the Culberson-Reeves county line. The outcrop is located in Rustler Hills, from which the formation obtained its name. The location of the study area is shown in Figure 2.0.1. The outcrop and downdip portions of the Rustler Aquifer in Texas as defined by the Texas Water Development Board (TWDB) are shown in Figure 2.0.2. The spatial extent of the Rustler Aquifer has been extended beyond the official TWDB boundaries into New Mexico.

Figure 2.0.3 shows the counties, roadways, cities, and towns in the study area. All or part of 12 Texas counties and two New Mexico counties are included in the study area. The locations of rivers, streams, lakes, and reservoirs in the study area are shown on Figure 2.0.4.

Figures 2.0.5 and 2.0.6 show the surface outcrop and downdip subcrop of the major and minor aquifers, respectively, in Texas that are present within the study area. Major aquifers located in the study area include portions of the Pecos Valley and Edwards-Trinity (Plateau) aquifers. In addition to the Rustler Aquifer, minor aquifers located in the study area include portions of the Capitan Reef Complex, Dockum, and Igneous aquifers.

The Rustler Aquifer encompasses part of the Far West Texas Regional Water Planning Area and the Region F Regional Water Planning Area (Figure 2.0.7). The aquifer includes part of the Middle Pecos Groundwater Conservation District, the Brewster County Groundwater Conservation District, and the Jeff Davis County Underground Water Conservation District (Figure 2.0.8). The Rustler Aquifer intersects portions of Texas Groundwater Management Areas 3, 4, and 7 (Figure 2.0.9). The Rustler Aquifer does not exist within the boundaries of any River Authority. The Rustler Aquifer is contained wholly within the Rio Grande basin (Figure 2.0.10).

Climate is a major control on flow in rivers and streams. The primary climatic factors are precipitation and evapotranspiration. For all but the Pecos River, rivers and streams in the study

Final Groundwater Availability Model for the Rustler Aquifer

area are normally dry. When flow does occur in the smaller rivers and streams, it rarely reaches the Pecos River but rather seeps into the channel beds or spreads out over broad valleys (Ashworth, 1990).

Final Groundwater Availability Model for the Rustler Aquifer

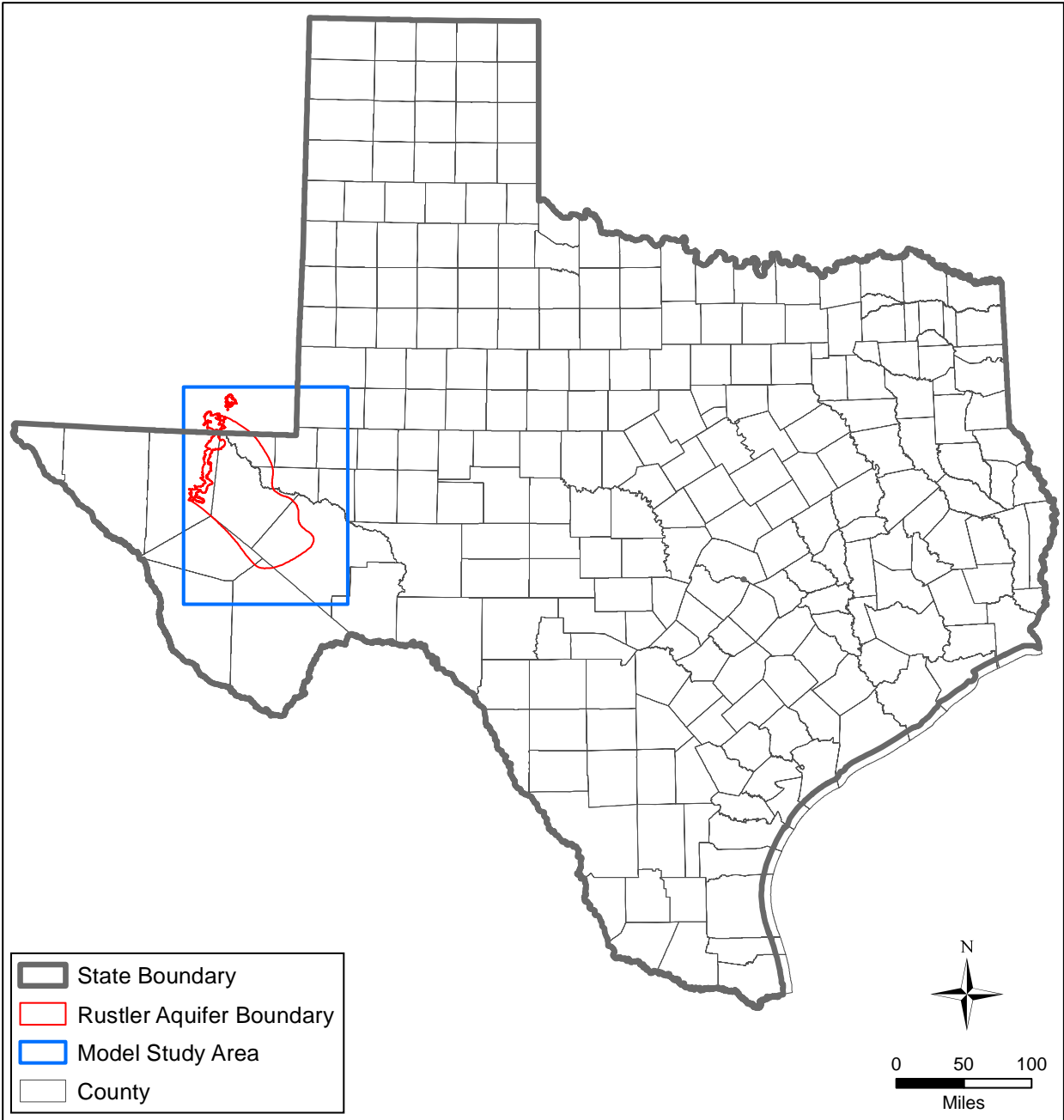

Figure 2.0.1 Study area for the Rustler Aquifer groundwater availability model (GAM).

Final Groundwater Availability Model for the Rustler Aquifer

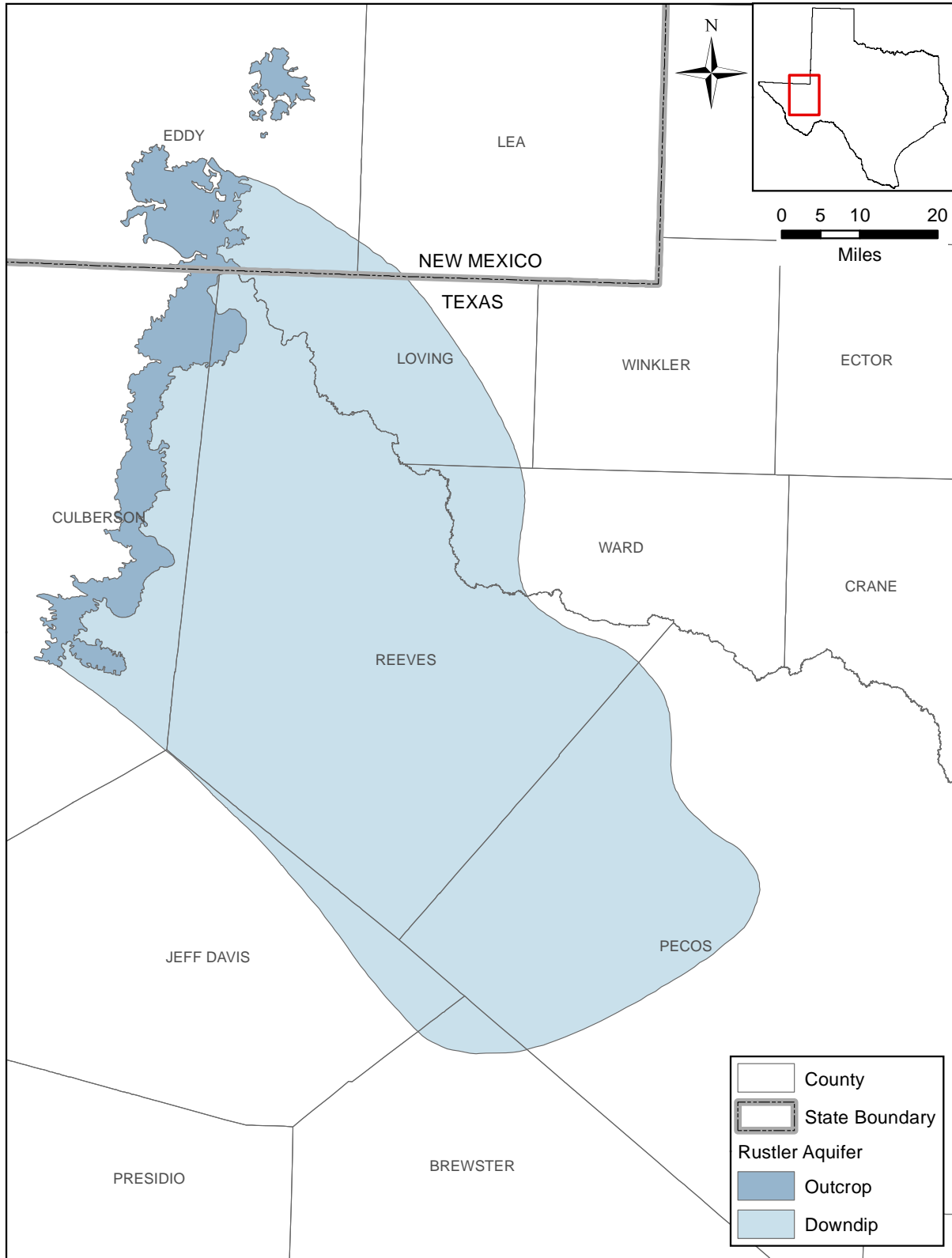

Figure 2.0.2 Rustler Aquifer boundaries in Texas as determined by the TWDB (TWDB, 2006b) and extrapolated into New Mexico.

Final Groundwater Availability Model for the Rustler Aquifer

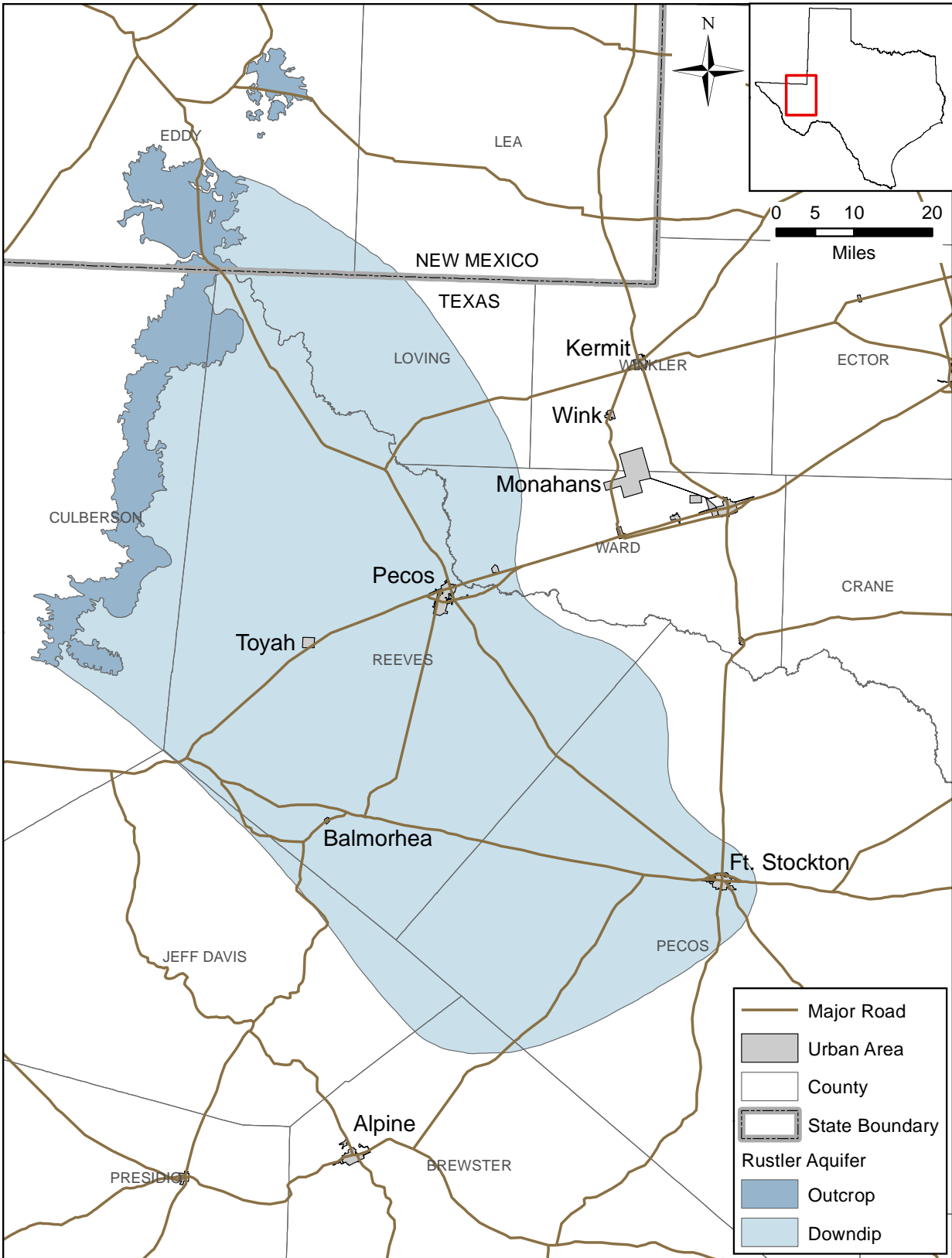

Figure 2.0.3 Cities and major roadways in the study area.

Final Groundwater Availability Model for the Rustler Aquifer

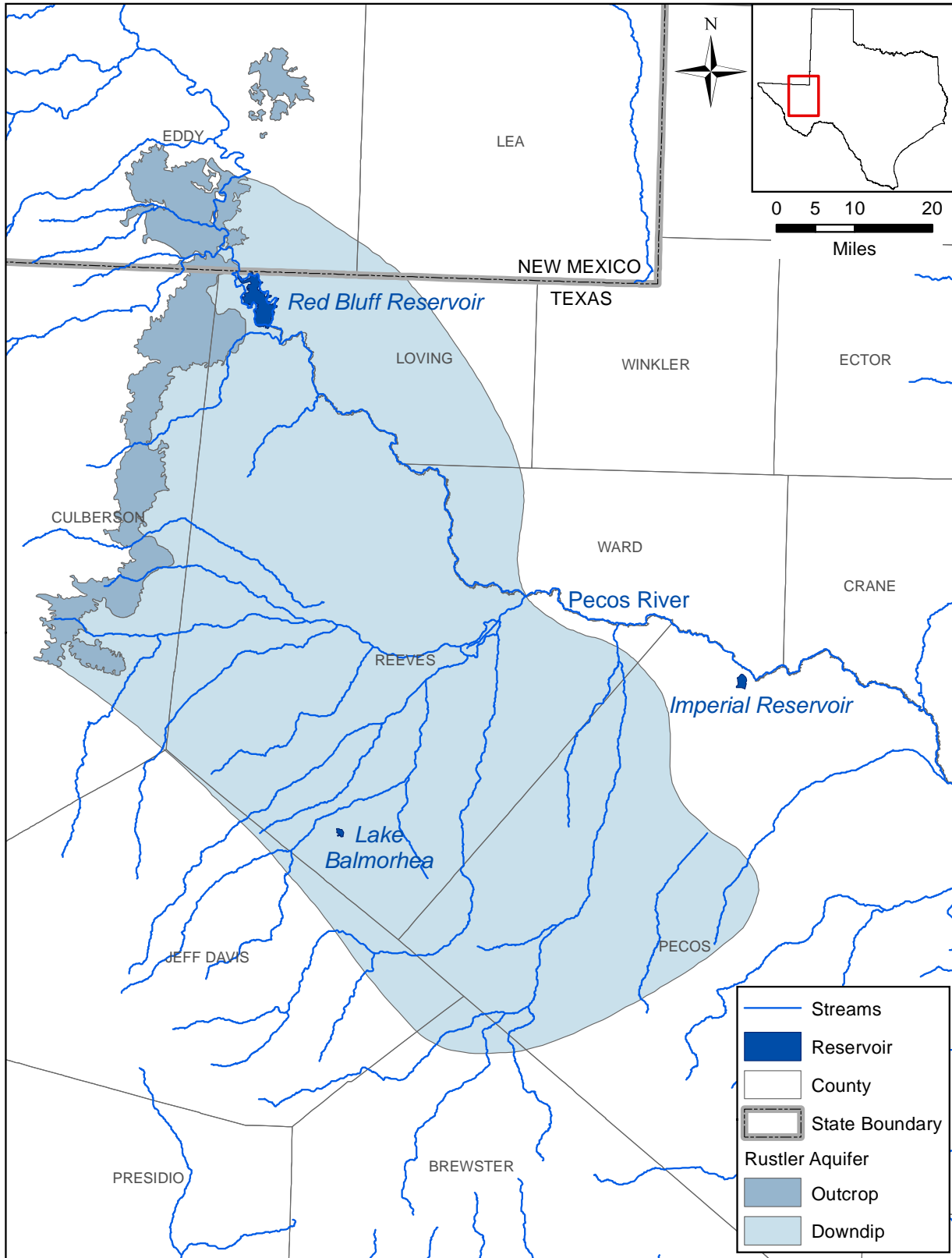

Figure 2.0.4 Rivers, streams, lakes, and reservoirs in the study area.

Final Groundwater Availability Model for the Rustler Aquifer

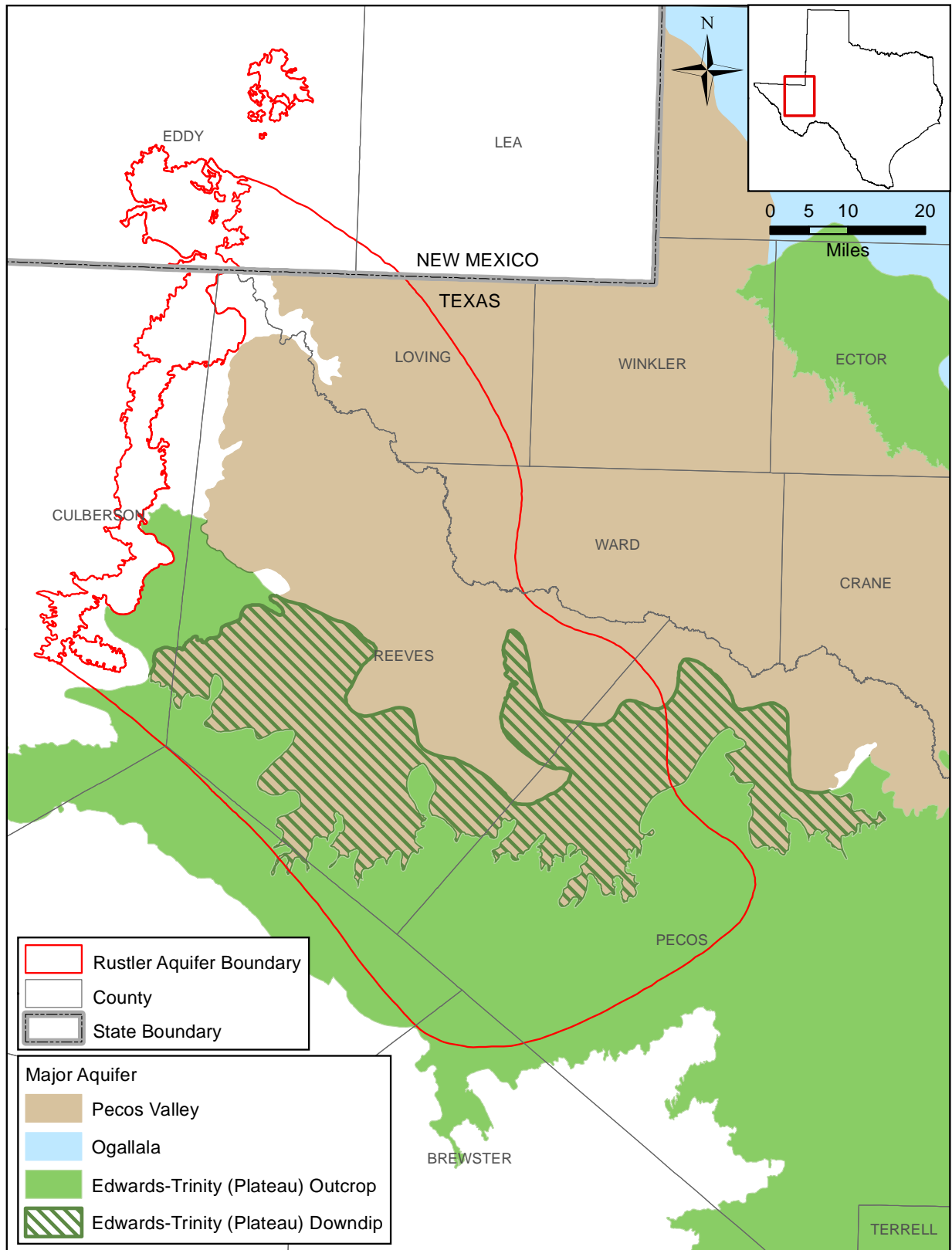

Figure 2.0.5 Major aquifers in Texas intersecting the study area (TWDB, 2006a).

Final Groundwater Availability Model for the Rustler Aquifer

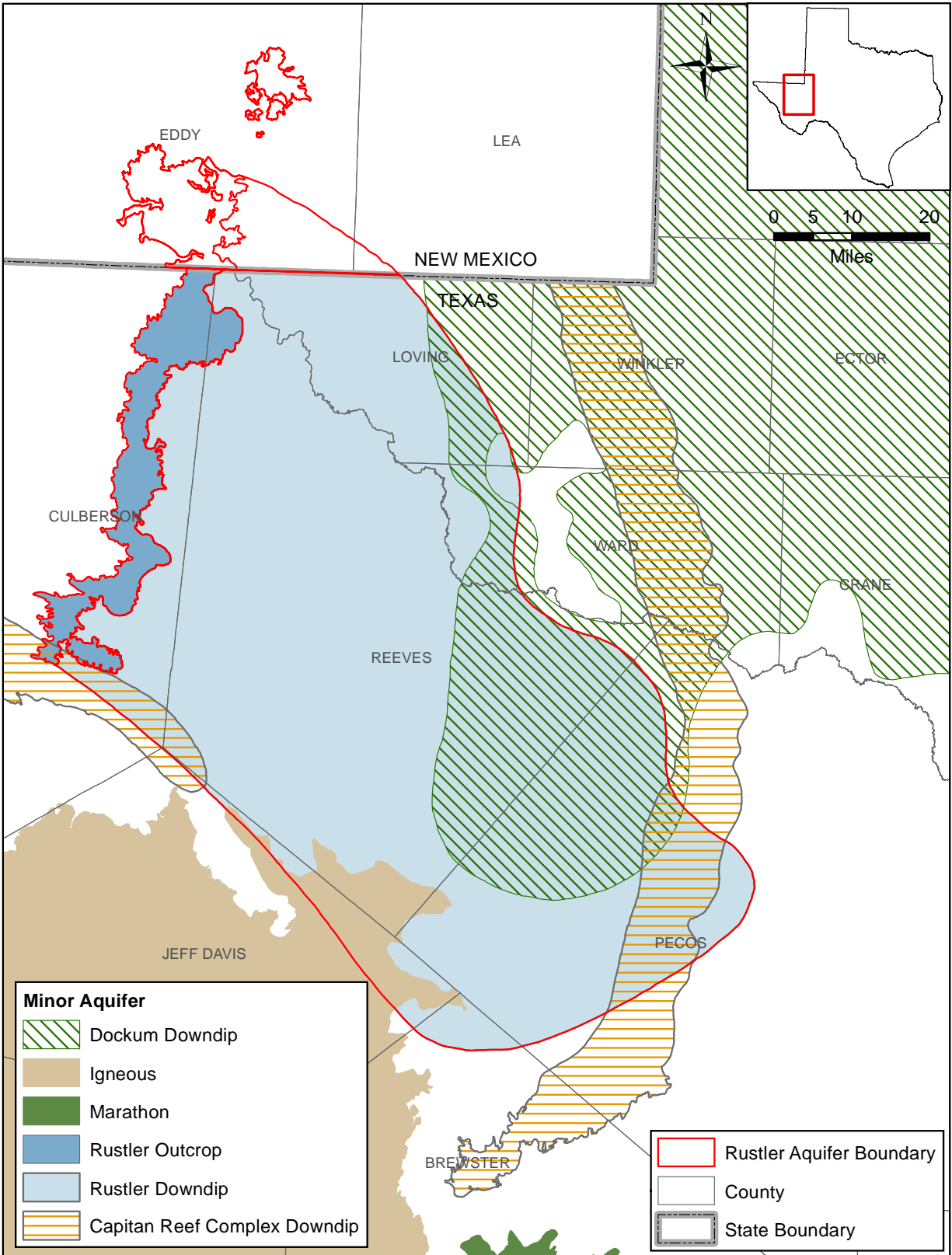

Figure 2.0.6 Minor aquifers in Texas intersecting the study area (TWDB, 2006b).

Final Groundwater Availability Model for the Rustler Aquifer

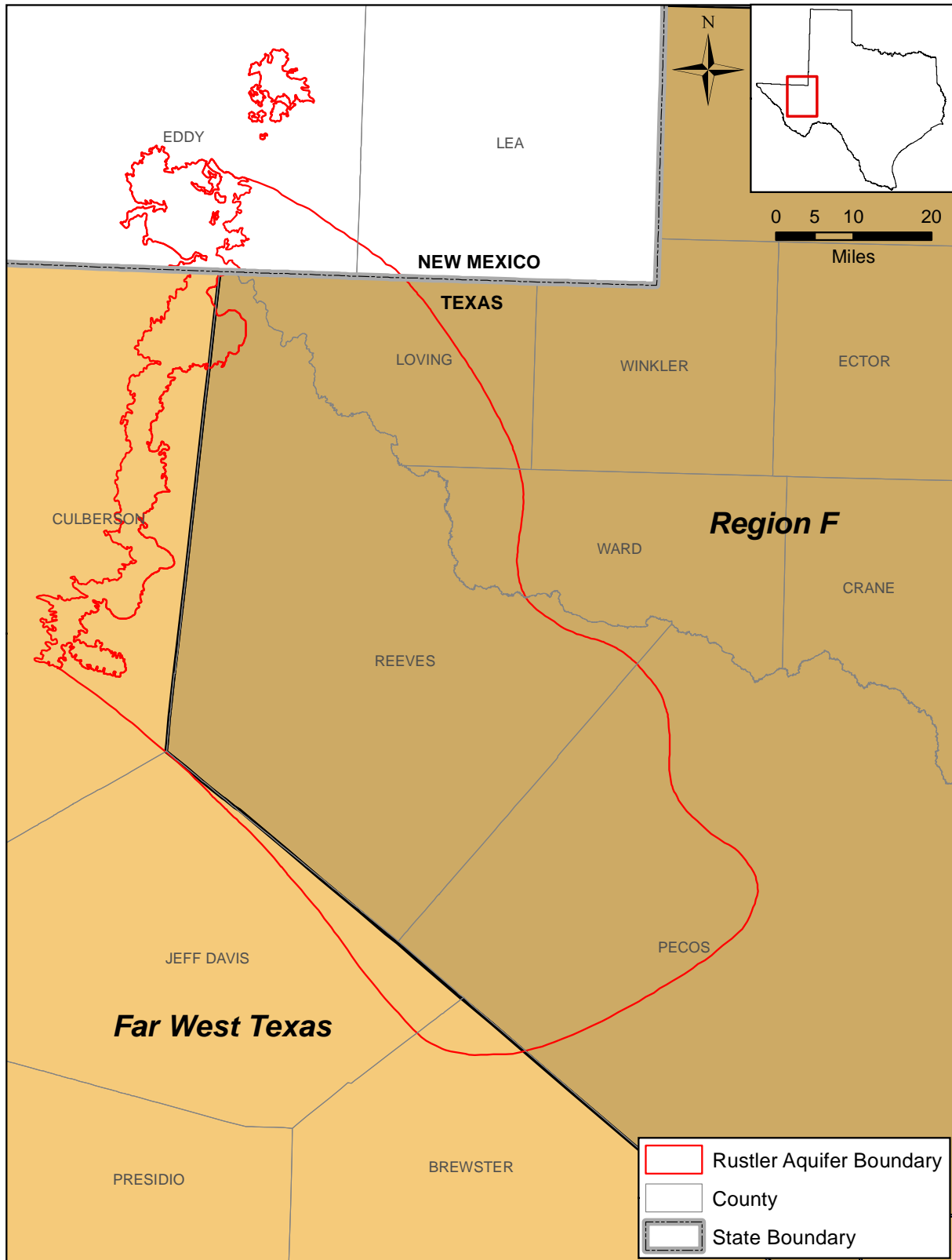

Figure 2.0.7 Texas Regional Water Planning Areas in the study area (TWDB, 2008).

Final Groundwater Availability Model for the Rustler Aquifer

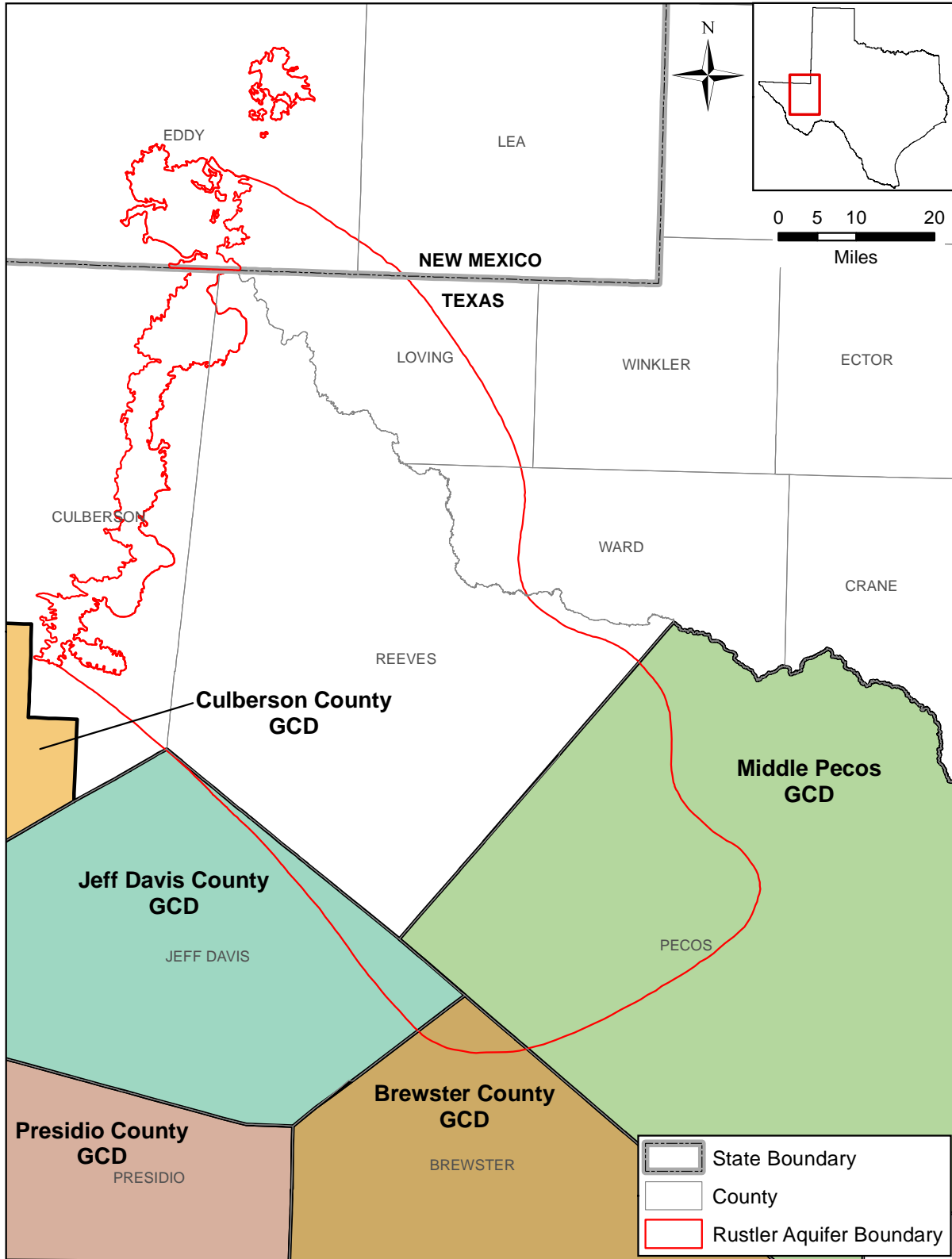

Figure 2.0.8 Texas Groundwater Conservation Districts (GCDs) in the study area (TWDB 2010a).

Final Groundwater Availability Model for the Rustler Aquifer

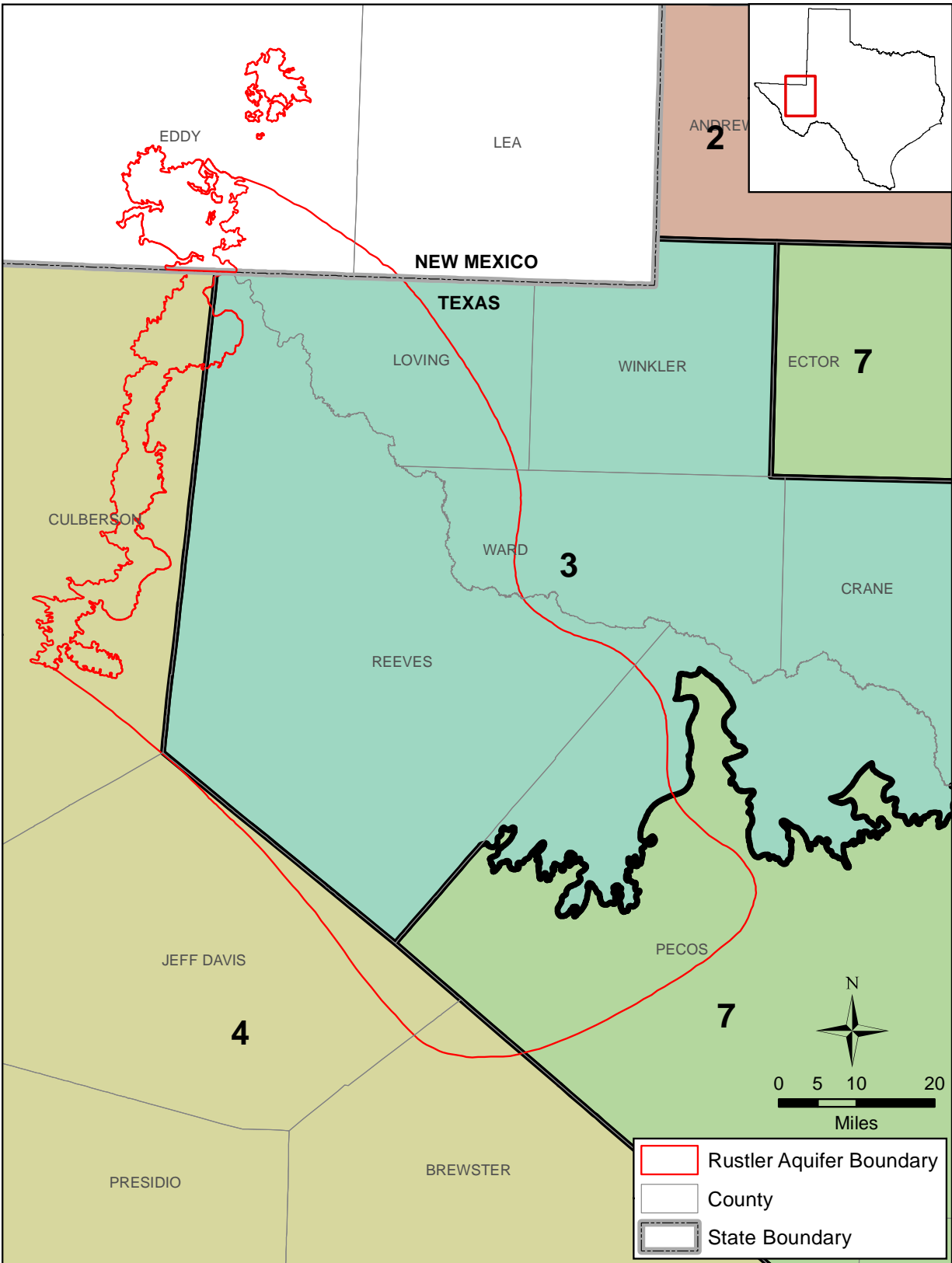

Figure 2.0.9 Texas Groundwater Management Areas in the study area (TWDB, 2007b).

Final Groundwater Availability Model for the Rustler Aquifer

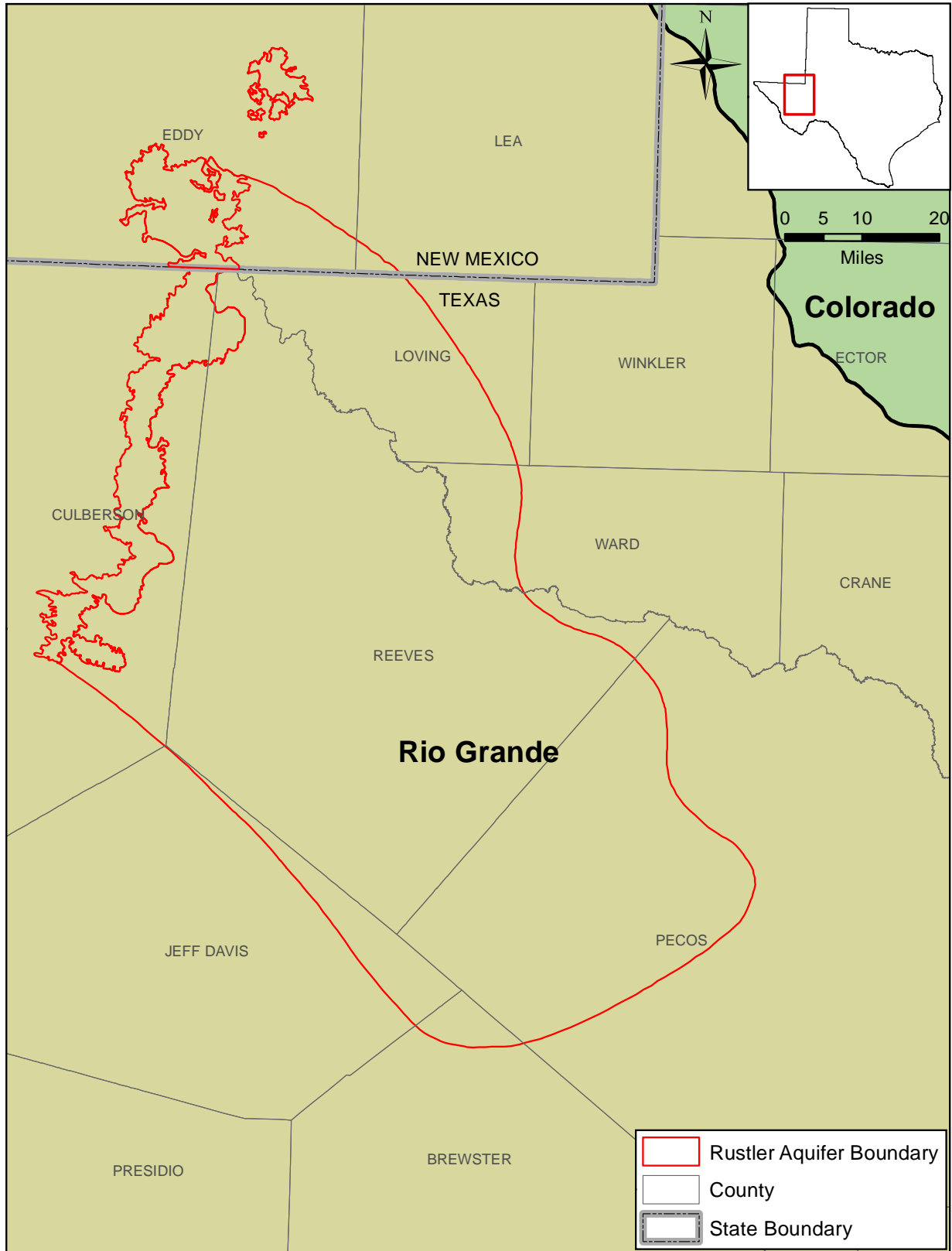

Figure 2.0.10 Major river basins in the study area (TWDB, 2010b).

2.1 Physiography and Climate

The study area is located in the Pecos Valley, Edwards Plateau, and High Plains sections of the Great Plains physiographic province and the Mexican Highland and Sacramento sections of the Basin and Range province (United States Geological Survey, 2002) (Figure 2.1.1). In the study area, the Pecos Valley section contains terraces and mesas of limited extent and is predominately alluvium filled in the central portion; the Edwards Plateau section is made up of a “stratum plain on a single massive and resistant limestone formation that dips gently south and east with the slope of the surface”, and the High Plains section is a near flat plateau (Leighty & Associates, Inc., 2001). Wermund (1996) describes the Basin and Range province in the study area as mountain peaks that rise abruptly from barren rock plains flanked by plateaus with nearly horizontal rocks less deformed than the adjacent mountains.

The study area is located predominately in the Chihuahuan Deserts Level III ecological region (Figure 2.1.2). This region consists of desert grassland, desert scrub in the lowlands and low mountains and wooded vegetation in the higher mountains (United States Environmental Protection Agency, 2010). A wide variety of plant and animal life can be found in this region. Texas Parks and Wildlife (2006) state that “more rare and endemic species can be found in this region than in any other part of Texas”.

Figure 2.1.3 provides a topographic map of the study area (United States Geological Survey, 2010a). Generally, the ground-surface elevation decreases from the north and southwest to the Pecos River, which runs through the central portion of the study area. The elevation of the ground surface varies from over 8,000 feet above mean sea level in the Davis Mountains in Jeff Davis County to less than 2,500 feet above mean sea level at the Pecos River along the border of Crane and Pecos counties.

The climate in the Texas portion of the study area, shown in Figure 2.1.4, is classified as Continental Steppe to the northeast, Subtropical Arid in the area of the Rustler Aquifer, and Mountain in a small portion of Jeff Davis County (Larkin and Bomar, 1983). The Continental Steppe climate is typical of continent interiors. It is a semi-arid climate characterized by large variations in daily temperatures, low relative humidity, and irregularly spaced rainfall of

moderate amounts (Larkin and Bomar, 1983). The Subtropical Arid climate is caused by the onshore flow of air from the Gulf of Mexico, which decreases in moisture content as it travels across the state. The Arid subdivision has the lowest moisture content in the western portion of the State. The Mountain climate is characterized by cooler temperatures, lower relative humidity, and mountainous precipitation anomalies typical of areas with orographic precipitation controls (Larkin and Bomar, 1983). The average annual temperature in the Texas portion of the study area ranges from a high of about 66 degrees Fahrenheit in the east to a low of about 58 degrees Fahrenheit in the southwest (Narasimhan and others, 2007) (Figure 2.1.5).

The Parameter-elevation Regressions on Independent Slopes Model (PRISM) precipitation dataset developed and presented online by the Oregon Climate Service at Oregon State University provides a distribution of average annual precipitation across the study area based on the period from 1971 to 2000 (Figure 2.1.6). The highest annual precipitation of about 23 inches per year occurs in the mountainous region in Jeff Davis County and the lowest annual precipitation of about 10 inches per year occurs in south-central Loving and Reeves counties.

Precipitation data are available at 38 Texas and eight New Mexico stations within the study area (Figure 2.1.7). In general, measurements are not continuous on a month by month or year by year basis for the gages. Annual precipitation recorded at five stations in the study area is shown in Figure 2.1.8. Figure 2.1.9 shows long-term average monthly variation in precipitation at selected gages in the study area. Precipitation is lower in January through April and November and December and higher from May through October.

The average annual net pan evaporation rate in the study area ranges from a high of 72 inches per year to a low of 55 inches per year (Figure 2.1.10). The pan evaporation rate significantly exceeds the annual average rainfall, with the greatest deficit of about 60 inches occurring near the confluence of the Crane, Ward, and Pecos county boundaries. Monthly variations in lake surface evaporation are shown in Figure 2.1.11 for four locations in the study area. These values represent the average of the monthly lake surface evaporation data from January 1954 through December 2004. Figure 2.1.11 shows that average lake evaporation peaks in June or July.

Final Groundwater Availability Model for the Rustler Aquifer

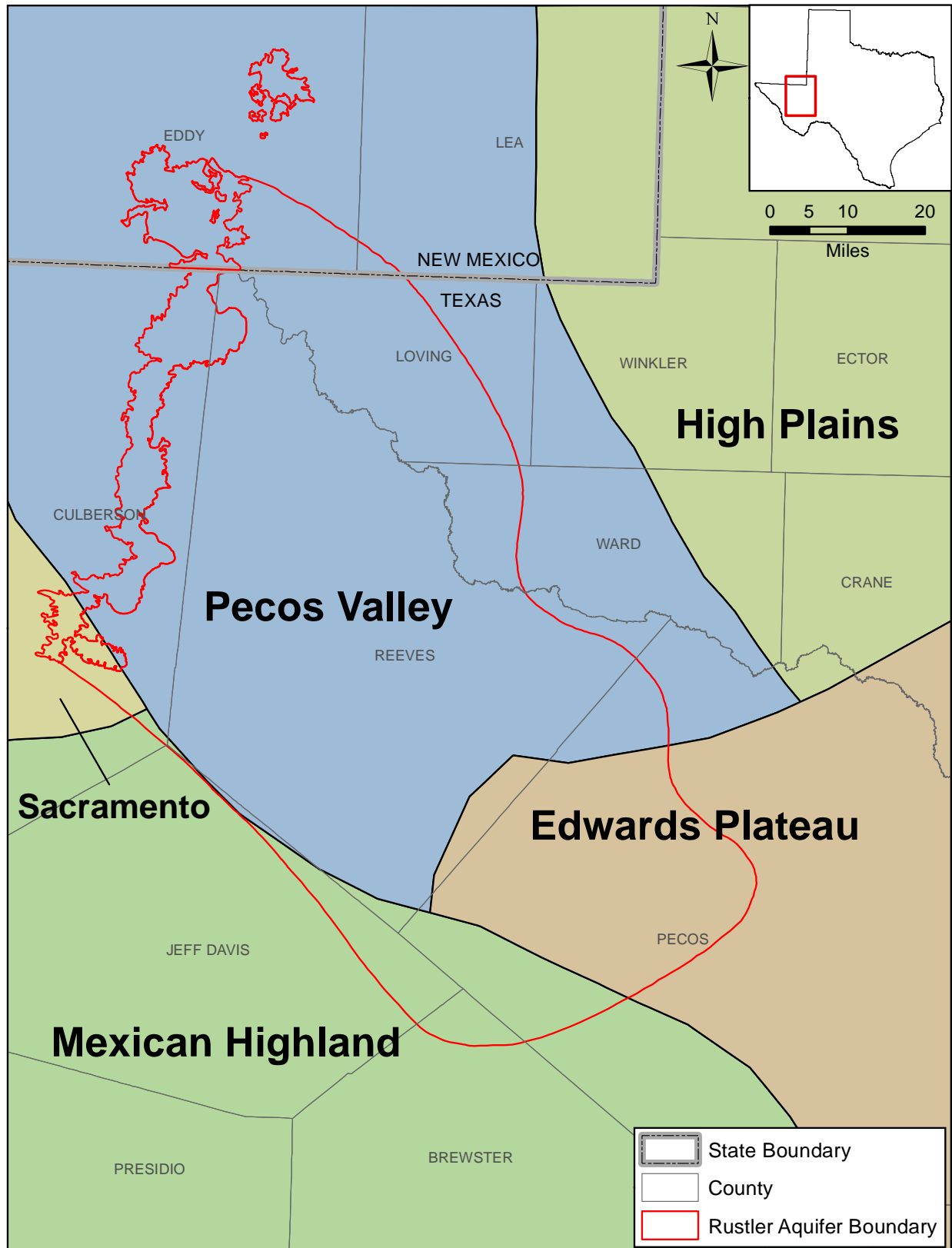

Figure 2.1.1 Physiographic provinces in the study area (United States Geological Survey, 2002).

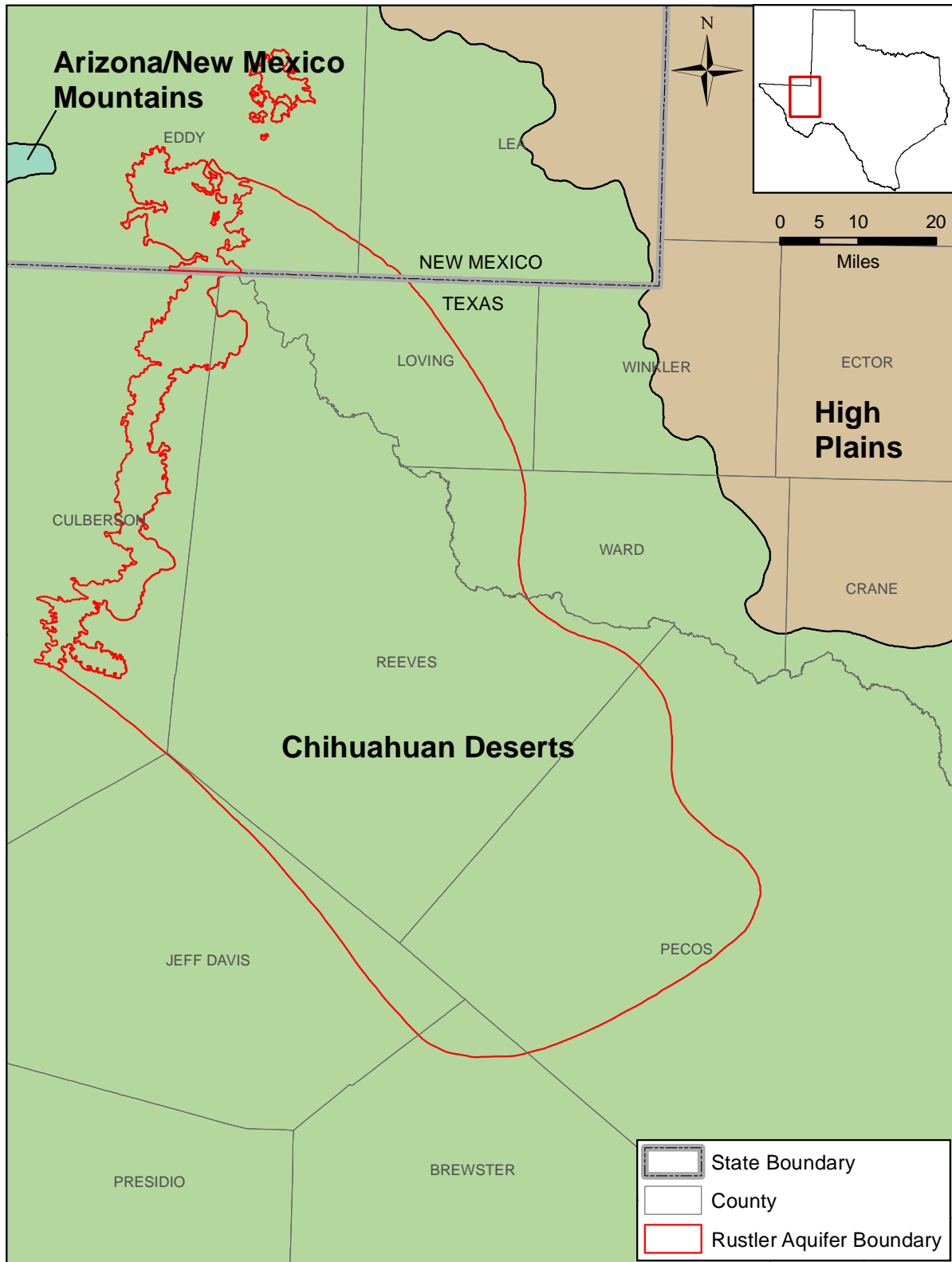

Figure 2.1.2 Level III ecological regions in the study area (United States Environmental Protection Agency, 2011).

Final Groundwater Availability Model for the Rustler Aquifer

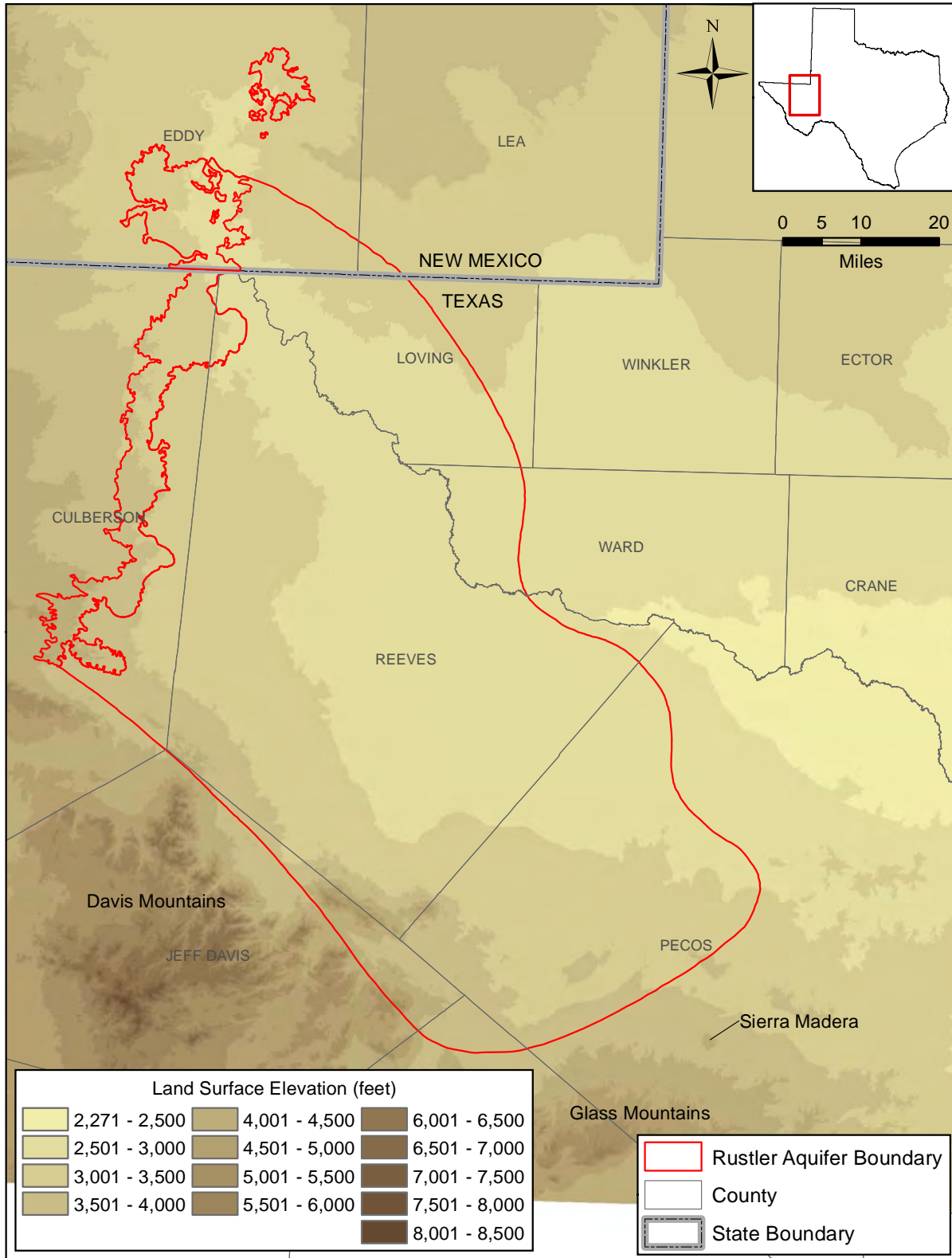

Figure 2.1.3 Topographic map of the study area showing land surface elevation in feet above mean sea level (United States Geological Survey, 2010a).

Final Groundwater Availability Model for the Rustler Aquifer

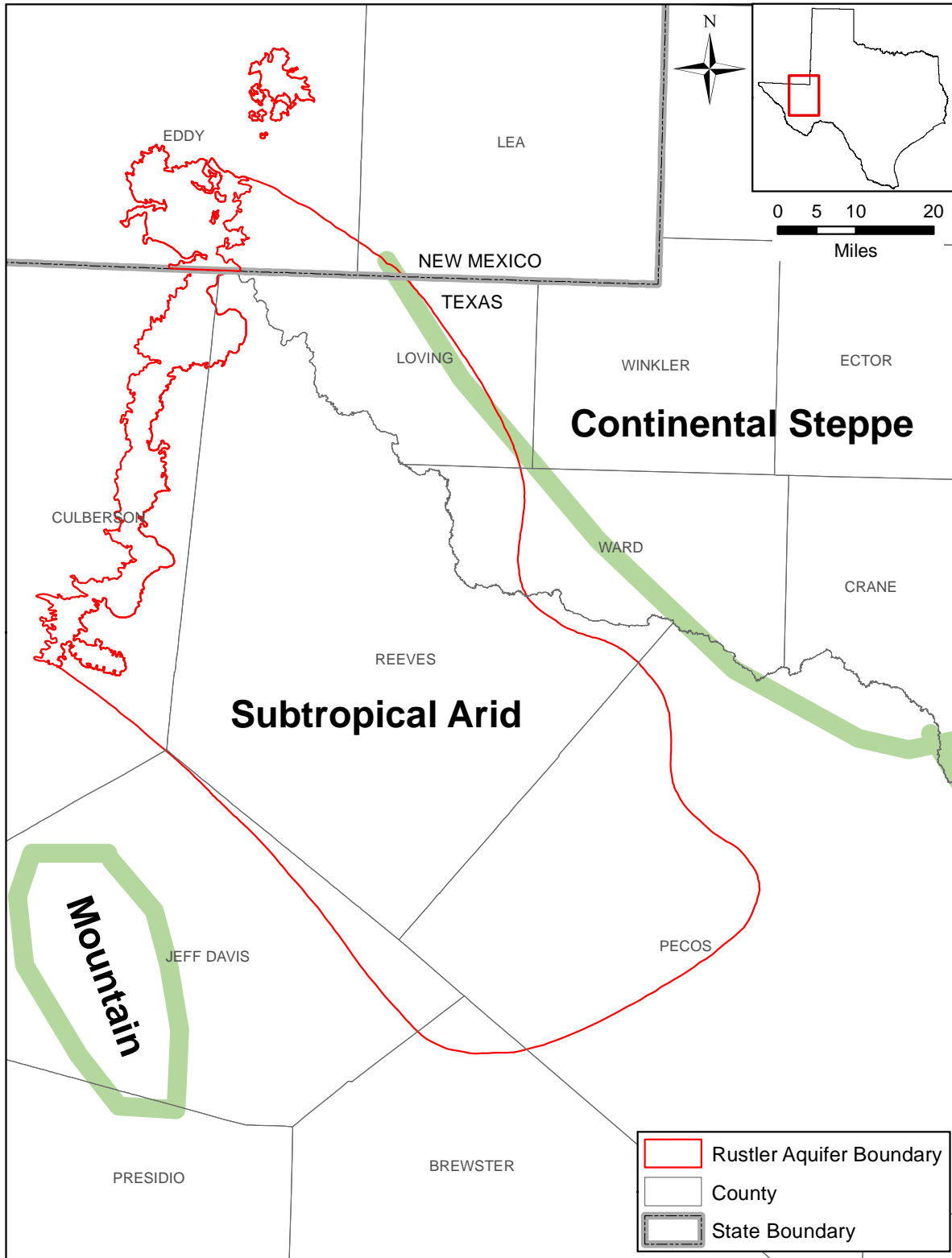

Figure 2.1.4 Climate classifications in the Texas portion of the study area (Larkin and Bomar, 1983).

Final Groundwater Availability Model for the Rustler Aquifer

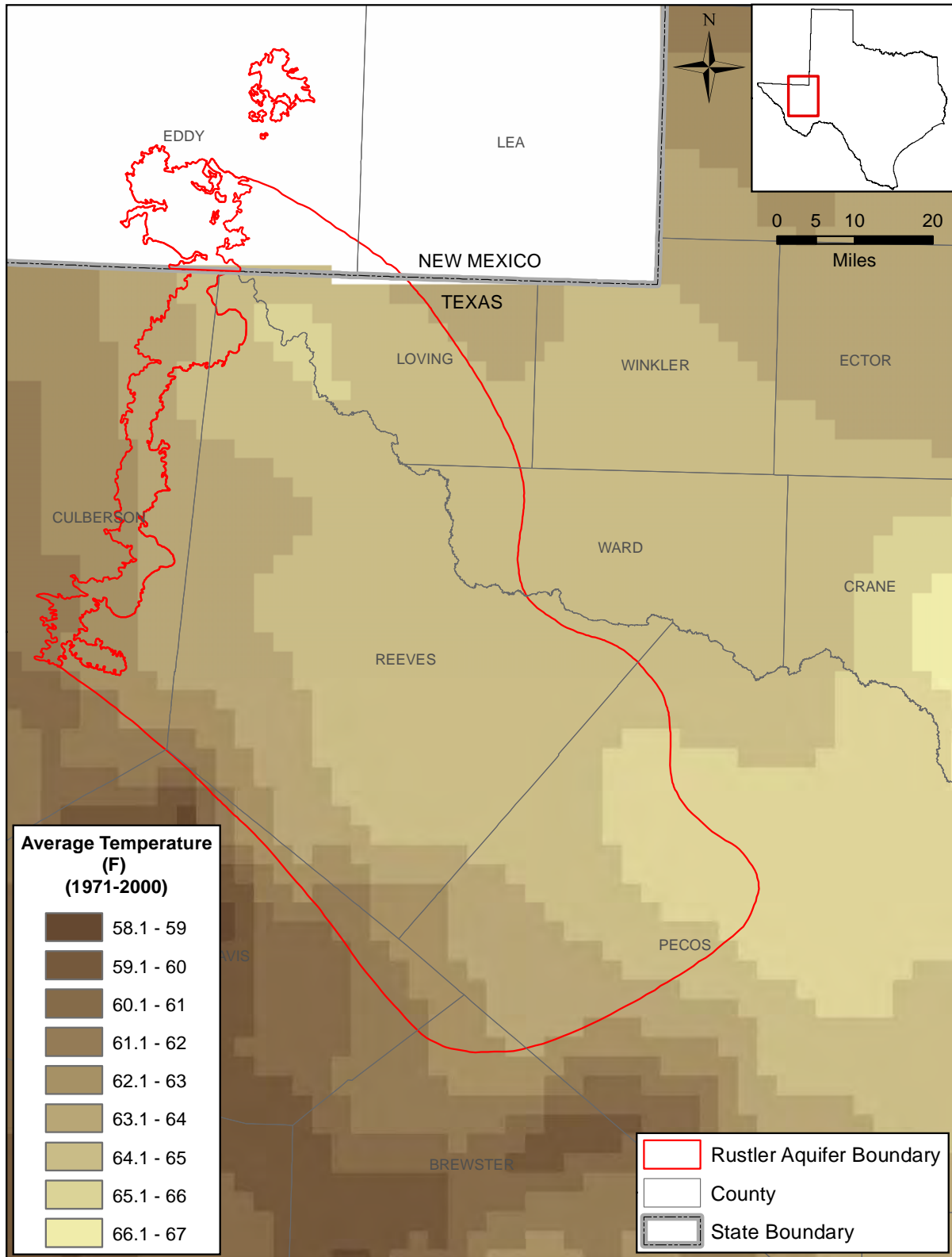

Figure 2.1.5 Average annual air temperature in degrees Fahrenheit for the Texas portion of the study area (Narasimhan and others, 2007).

Final Groundwater Availability Model for the Rustler Aquifer

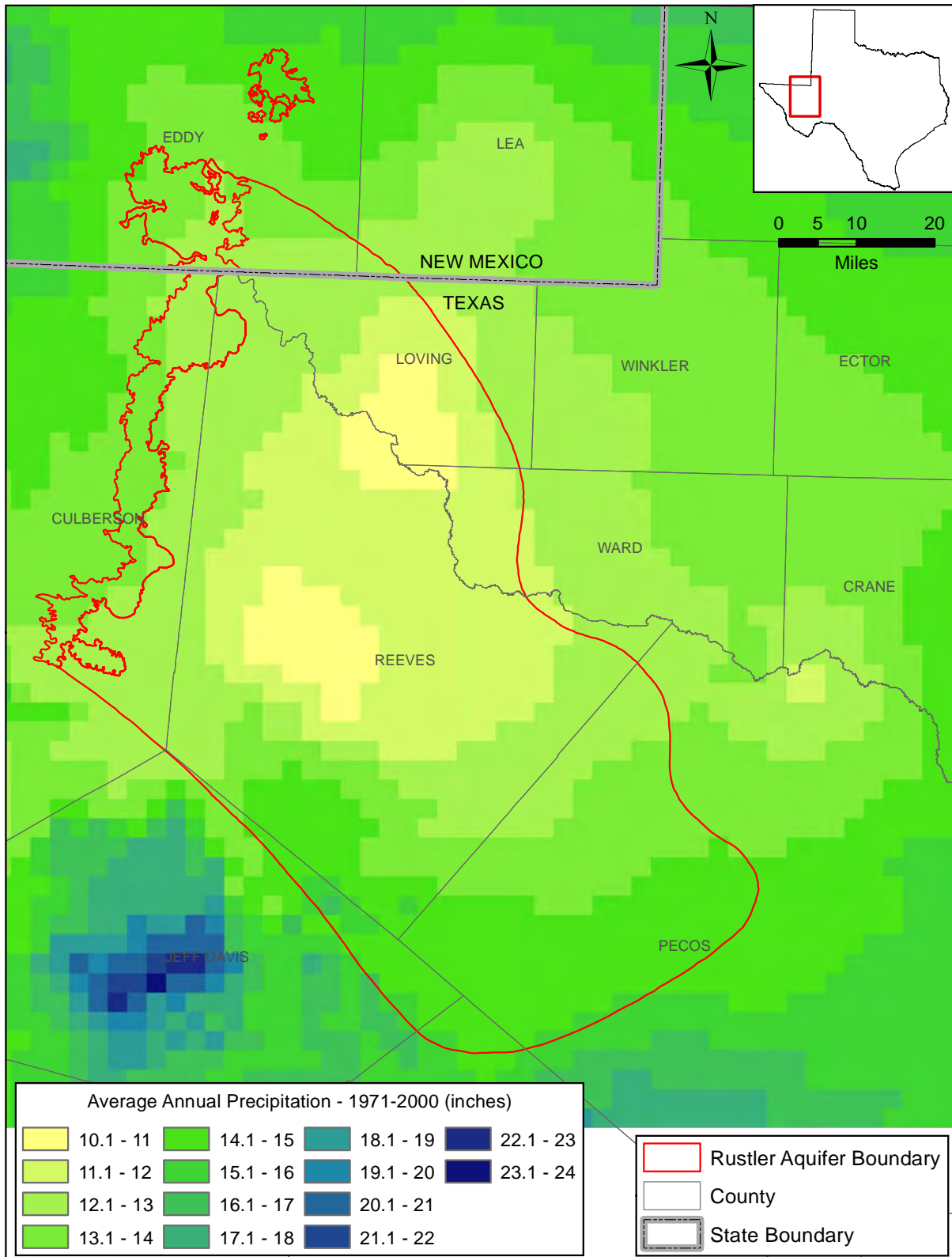

Figure 2.1.6 Average annual precipitation in inches per year in the study area for the time period 1971 to 2001 (Oregon State University, 2002).

Final Groundwater Availability Model for the Rustler Aquifer

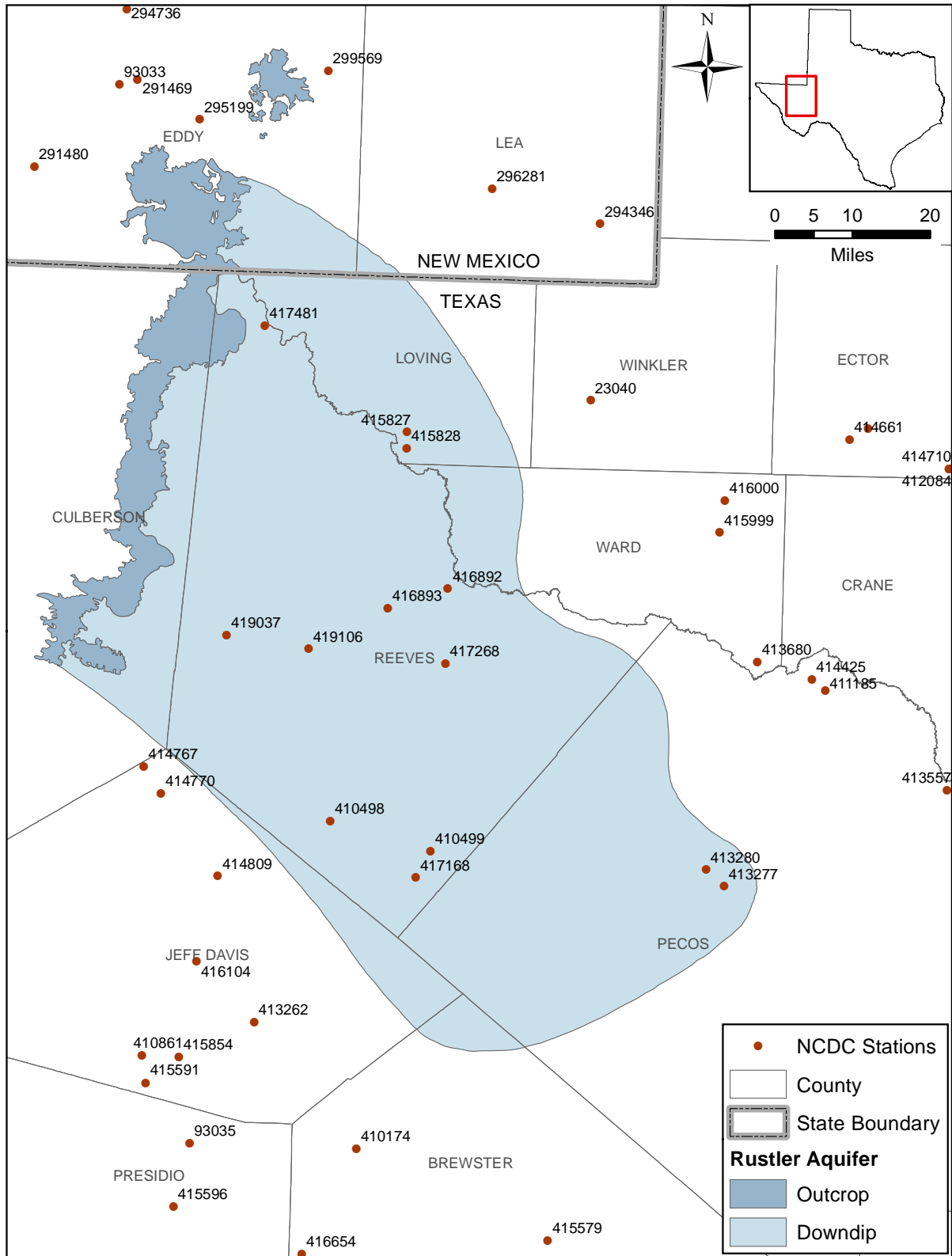

Figure 2.1.7 Location of precipitation gages in the study area (National Climatic Data Center, 2001).

Final Groundwater Availability Model for the Rustler Aquifer

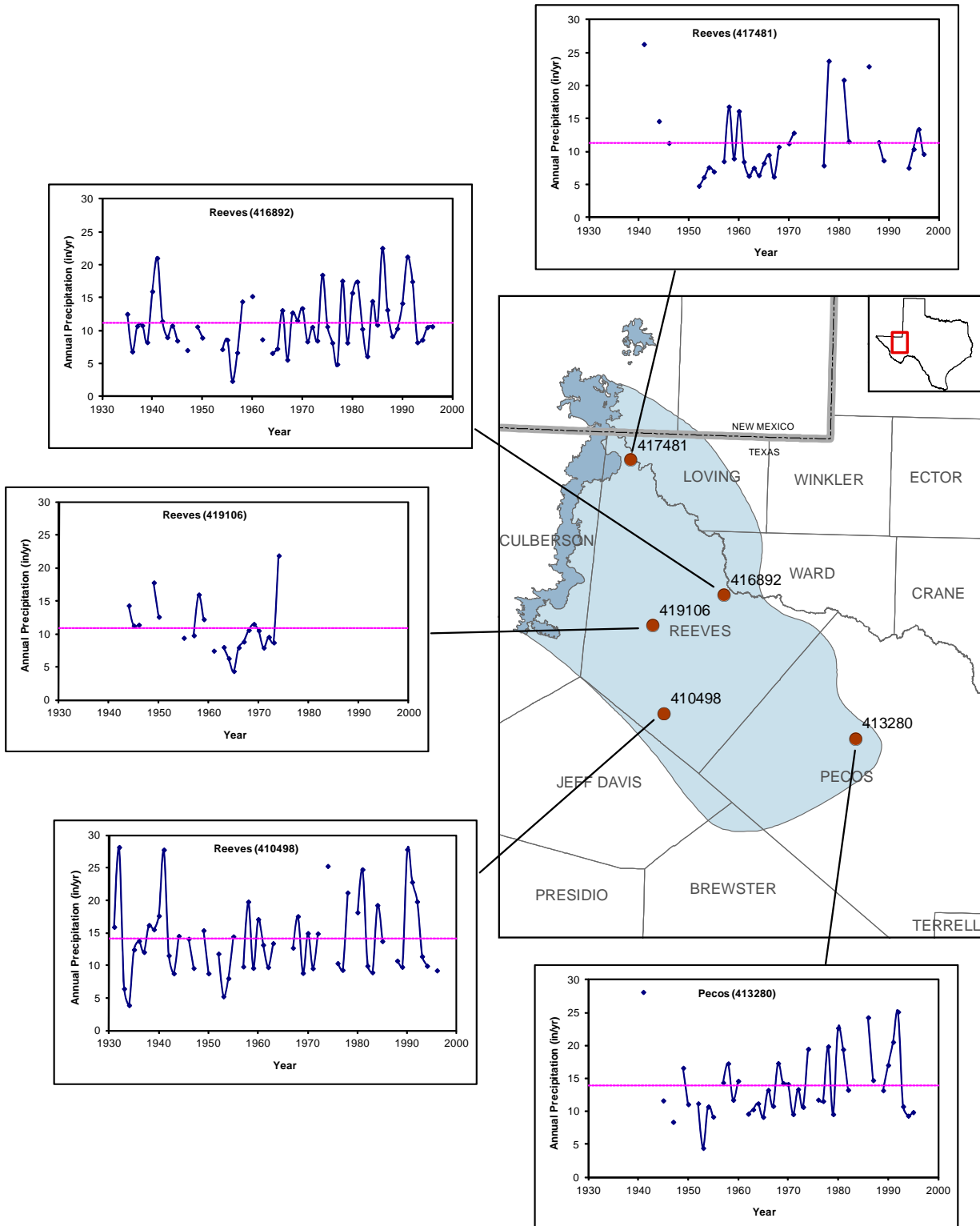

Figure 2.1.8 Selected time series of annual precipitation in inches per year in the study area. (A discontinuous line indicates a break in the data. The dashed red line represents the mean annual precipitation.) (National Climatic Data Center, 2001).

Final Groundwater Availability Model for the Rustler Aquifer

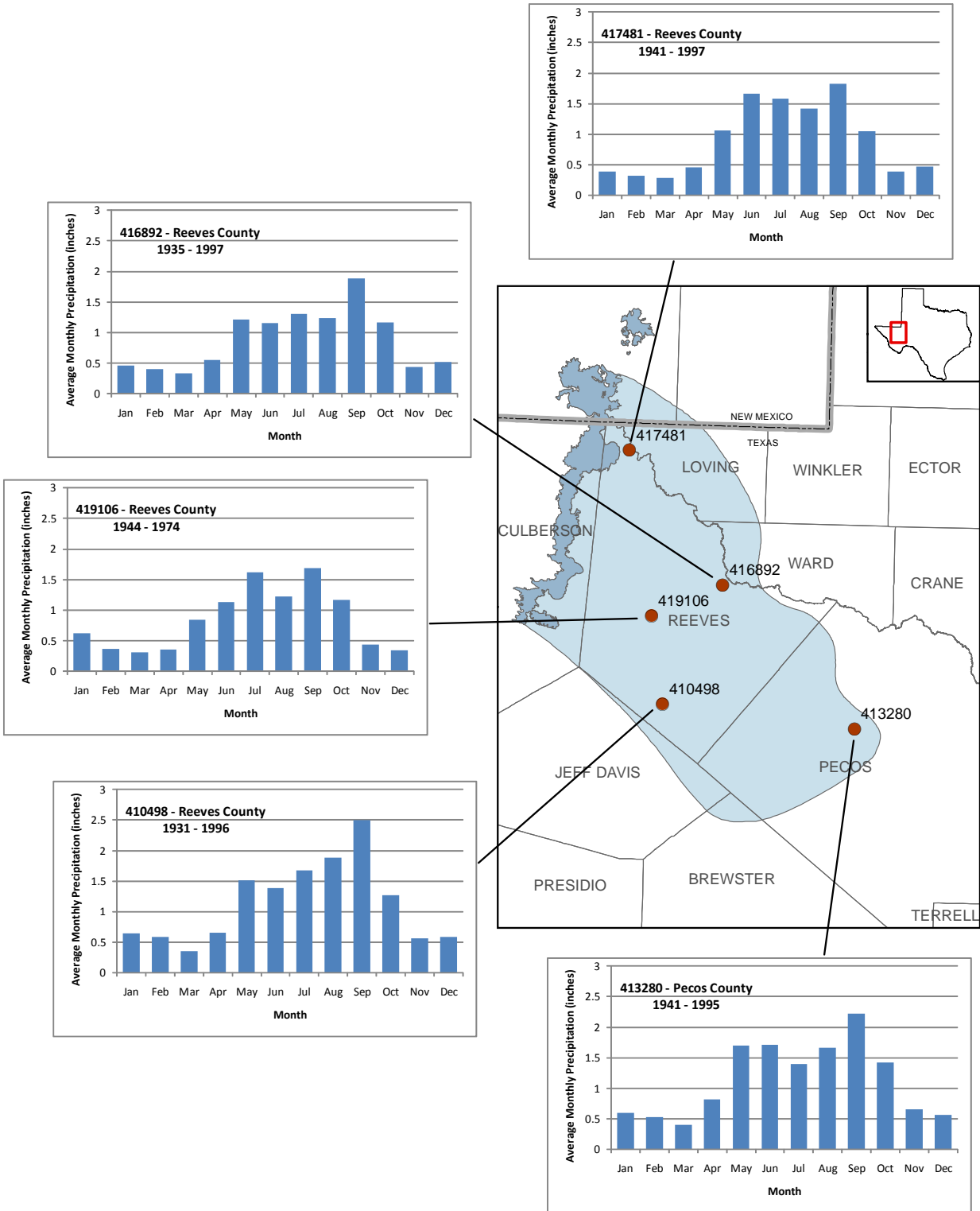

Figure 2.1.9 Selected time series of average monthly precipitation in inches per month in the study area (National Climatic Data Center, 2001).

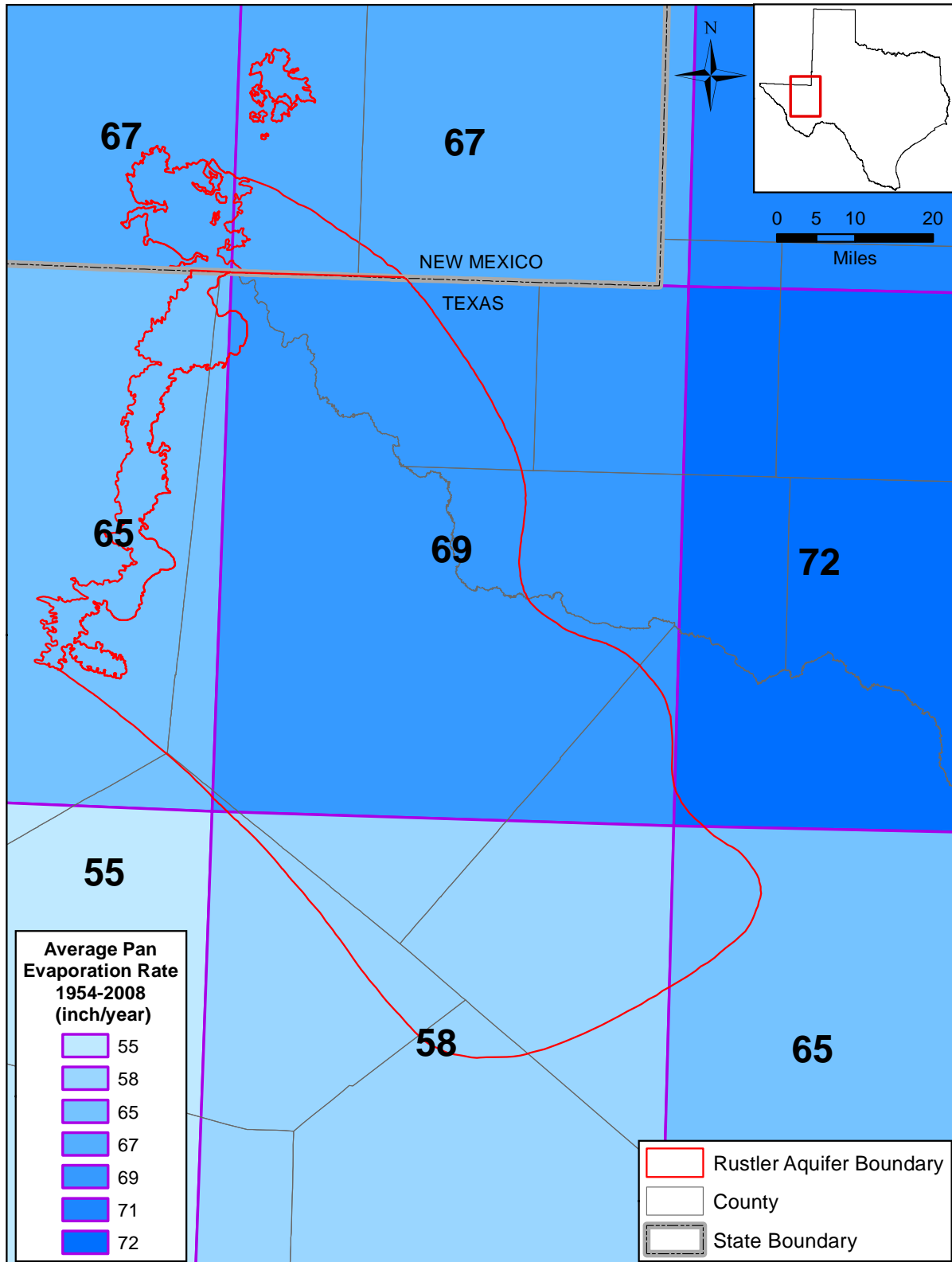

Figure 2.1.10 Average annual net pan evaporation rate in inches per year over the study area (TWDB, 2009a).

Final Groundwater Availability Model for the Rustler Aquifer

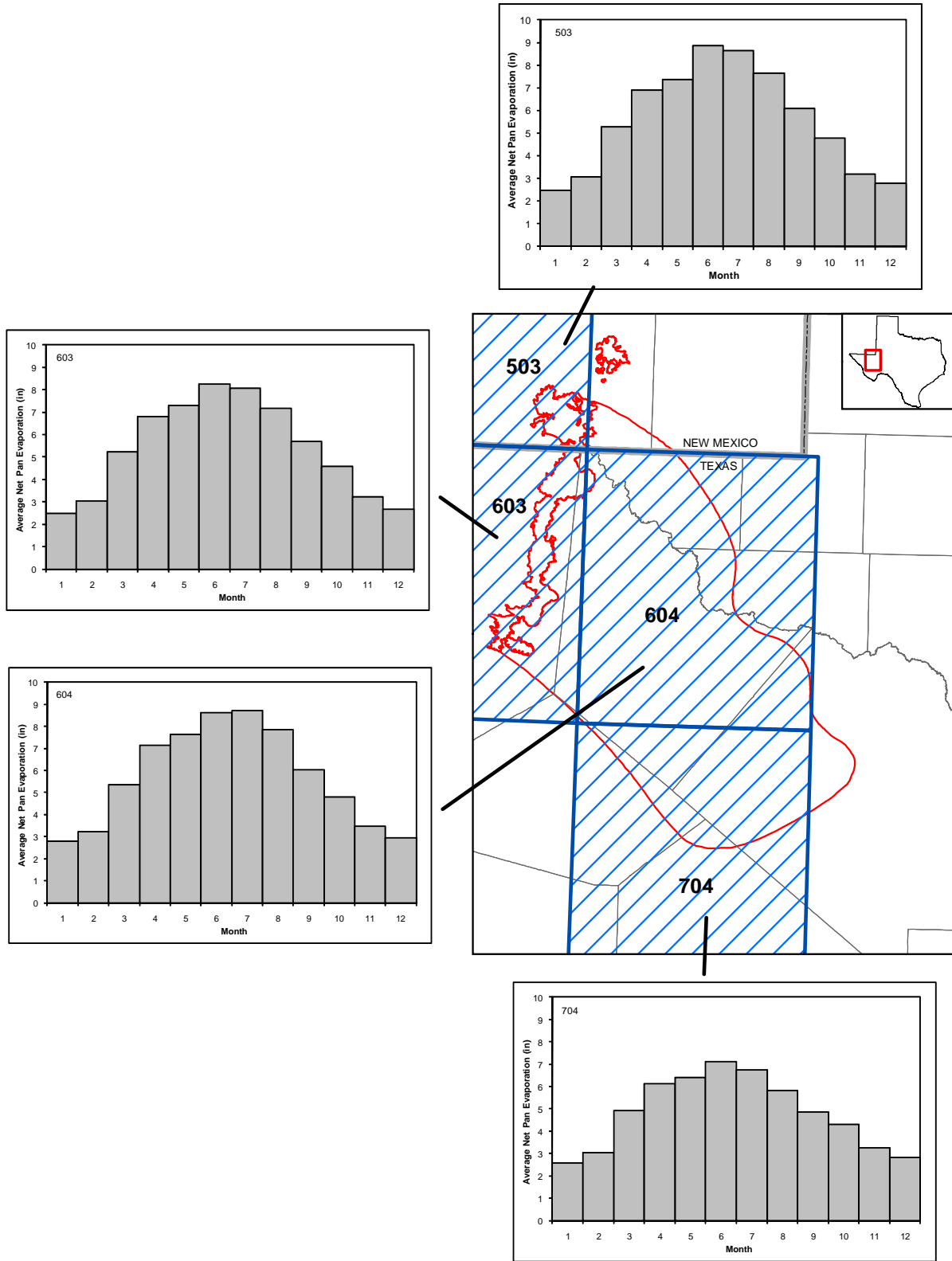

Figure 2.1.11 Average monthly lake surface evaporation in inches at selected locations in the study area (TWDB, 2009a).

This page intentionally left blank.

2.2 Geology

This section provides a brief discussion of the geology of the study area. The discussion is divided into the structural setting, the general geologic history, the tectonic history, the surface geology, the stratigraphy of the Rustler Formation, and a description of geologic structural cross-sections through the study area.

Structural Setting

The structural setting for the study area is shown in Figure 2.2.1 (after Armstrong and McMillion, 1961; Sharp and others, 2003). The primary structural features within the study area include the Delaware Basin, the Central Basin Platform, the Diablo Platform, the Hovey Channel, and the Sheffield Channel. Major faults within the study area are generally associated with the margins of the Delaware Basin to the south. Boghici (1997) found geophysical evidence of faulting in the area of Fort Stockton near a spring system, Armstrong and McMillion (1961) discuss faulting near the town of Belding, and this study has identified many more fault systems that are important to the Rustler Aquifer. The faults from all of these sources are discussed in Section 4.2.

General Geologic History

Approximately 500 million years ago, the southern margin of the continent in southeastern New Mexico and west Texas began to subside, and marine environments transgressed across this large depression. Later in the Paleozoic Era, the Central Basin Platform rose relative to adjacent parts of the basin to separate it into the Delaware Basin (west) and Midland Basin (east) (see Figure 2.2.1). Until formation of the Capitan Reef, the Sheffield Channel connected the Delaware and Midland basins. Uppermost Paleozoic sediments deposited in the Delaware Basin are dominated by evaporite rocks because circulation to the open ocean was restricted when a reef-backreef rock sequence grew across the Hovey Channel. The Permian-age Rustler Formation is the uppermost of these units with significant evaporite beds. Non-marine sediments were deposited during late Permian and Triassic time across most of the study area. From approximately the end of Triassic to Miocene time, the northern part of the area was largely exposed, with one transgression near mid-Cretaceous time. The southern to southeastern part of

the study area includes a thicker, Cretaceous-age rock section that is dominated by shallow marine sediments. Tertiary tectonism formed many volcanic deposits that are predominantly located in the southernmost portions of the study area. During Cenozoic time, erosion of surrounding highlands and later streams deposited the alluvial material of the Pecos Valley Alluvium. Thickest accumulations of this formation are found in Reeves and western Pecos counties.

Tectonic History

As deposition of the Salado Formation came to a close, most of the study area shows evidence of a large, shallow, nearly flat saline sea. Observed cycles of desiccating upward sedimentation (Holt and Powers, 1990a, 1990b, 2011) are most likely mainly due to climatic variation rather than tectonics, based upon the scale of continuity to beds of the Salado Formation.

While the Rustler Formation also displays great continuity for many beds across the study area and beyond, thickness variations also show differential subsidence, with a depocenter in the eastern Delaware Basin. The carbonate beds of the Rustler Formation (i.e., the Culebra Dolomite and Magenta Dolomite members) are relatively consistent in thickness across the area. In contrast, the lower, middle, and upper members of the formation (Los Medaños, Tamarisk, and Forty-niner, respectively) each display thickness and facies changes consistent with a subsiding depocenter in the eastern part of the Delaware Basin (Holt and Powers, 1988; Powers and Holt, 1999, 2000). Holt and Powers (1988) interpreted thickness and elevation changes across the eastern Delaware Basin-Central Basin Platform margin that are consistent with some fault displacement. Schiel (1988, 1994) also proposed fault displacements that post-dated the Rustler Formation and affected deposition of the Dewey Lake Formation. These faults are similar to the trends and locations of faults along the eastern margin of the Delaware Basin shown by Hills (1984). Thus, there are indications of movement along these boundary faults through late Permian to early Triassic time.

The Tessey Limestone was also deposited during Permian time. This formation consists of a massive limestone that is considered to be equivalent to at least part of the Ochoan series Salado and Rustler formations. After deposition of the Tessey Limestone, Permian-age deposits, including the Tessey Limestone, were uplifted and tilted forming the Glass Mountains.

The Dewey Lake Formation was deposited over the Rustler Formation at the end of the Permian age. The probable source for the fine-grain material in the red beds of this formation was marginal lands located to the north, west, and south of the Delaware Basin.

The Dockum Aquifer in the study region generally consists of variable thicknesses of two formations; the upper Chinle Formation and the lower Santa Rosa Formation. The Triassic-age Dockum Group represents non-marine deposits indicating the area had clearly been lifted above sea level by the end of Permian time. Although widely variable, drainage regimes on the Dockum Group are generally eastward (e.g., McGowen and others, 1979) consistent with some relative uplift to the west in or beyond the current study area.

Throughout much of the area, there are only isolated deposits of Cretaceous rocks, generally considered upper lower Cretaceous. They include basal conglomerates to sands overlain regionally by sediments that show evidence of repeated sea level rises and falls that may be more associated with climatic variations than with local tectonics. Nevertheless, the regional pattern suggests that much of this area remained above sea level but without major tectonic activity during Cretaceous time.

The area underwent erosion during the Jurassic period as evidenced by the lack of Jurassic-age sediments. During early to mid-Cenozoic time, the area appears to have remained generally high, following the Laramide uplift. On the southern flank of the study area, the Davis and Barilla Mountain volcanic areas were active mid-Cenozoic. Igneous rocks of similar age intruded along a narrow northwest-southeast trend along the northwestern edge of the study area.

With Basin and Range activity, the western Delaware Basin was lifted up, providing much of the approximate one degree eastward regional dip. This also led to erosion, as well as exposure of evaporites and solution.

During Quaternary time, the climate in the study area became more arid resulting in the deposition of windblown sand. Erosion of surrounding high areas lead to the deposition of alluvial silt, sand, and gravel deposits. Collapse of beds caused by the solution and removal of salts in the Permian-age sediments resulted in thick accumulations of alluvial deposits over much of the study area in late Tertiary through Quaternary time. Armstrong and McMillion (1961)

postulate that the collapse occurred in Triassic or later Permian time based on formation thicknesses at the location of the collapse feature. They suggest that post-Permian movement along the Capitan Reef fractured overlying rock creating channels through which water circulated and dissolved evaporates. This removal of salts resulted in collapse of the overlying beds. Post-collapse deposition filled the feature resulting in thick accumulations of sediments. Maley and Huffington (1953) and Richey and others (1985) also attribute the thick accumulations of Cenozoic fill to dissolution and collapse of underlying evaporate formations.

Surface Geology

Figure 2.2.2 provides a geologic map of the study area. The outcrop of the Rustler Formation, which consists of dolomite, dolomitic limestone, limestone breccia, gypsum, and mudstone with minor siltstone and sandstone near the base (Hentz and others, 1989), is located in the Rustler Hills (the source of the formation name) in Culberson County. In general, a sequence of anhydrite and gypsum with interbedded dolomite makes up the upper portion of the formation and clastics primarily make up the lower portion of the formation (Hiss, 1976). Locally, minor amounts of salt and limestone occur in the Rustler Formation (White, 1971). Over the majority of the study area, the predominate surficial deposit are Quaternary-age alluvial sediments.

Rustler Formation Stratigraphy

The number of recognized members of the Rustler Formation and the overlying and underlying formations varies from west to east across the study area as shown in Figure 2.2.3. East from the outcrop into Pecos County and along the terminal edges of the Delaware Basin to the south in the Glass Mountains, the lithology and contact relationships within the Rustler Formation and underlying Salado Formation change. Moving south into the Glass Mountains, the Salado and Rustler formations are thought to be facies equivalents to the Tessey Limestone, which is a massive limestone that crops out in the Glass Mountains in southwestern Pecos County (see Figure 2.1.3). The Rustler Formation continues and thins east of the Capitan Reef and onto the Central Basin Platform.

Cross-Section Discussion

Figures 2.2.4 through 2.2.6 show three representative cross-sections from the base of the Rustler Formation (top of the Salado Formation in most cases) to the ground surface developed as part of this GAM. These cross-sections, which were created using the structural data presented in Section 4.2, depict the complex stratigraphic relationships in the study area. The locations of the faults shown in the cross-sections are given in Section 4.2.

Figure 2.2.4 shows cross-section A-A', which is a north south cross-section extending from Lea County, New Mexico into Brewster County, Texas. This section shows the structural complexity defining the basin. Moving south from Loving County into Ward County, a downthrown block is encountered where the Rustler Formation has been completely disconnected by a northwest to southeast trending fault to the north and a northeast to southwest trending fault to the south. In this area, the Dewey Lake Formation is still present but the Dockum Aquifer is not present across the entire downthrown region. The Pecos Valley Aquifer is very thick in the Pecos River Valley in Ward County. Continuing south, the land surface continues to rise from the Pecos River and starts to lose the overlying Dockum Aquifer and pick up the overlying Edwards-Trinity (Plateau) Aquifer. In western Pecos County, a normal fault that trends west-northwest to east-northeast is encountered where the Rustler Formation has been significantly downthrown to the north and basinward.

Figure 2.2.5 shows cross-section B-B', which originates at the western edge of the Rustler Formation outcrop in Culberson County and extends east onto the Central Basin Platform and into Crane County. This section shows a steeply dipping Rustler Formation into western Reeves County and a significant thickness of Edwards-Trinity (Plateau) and Pecos Valley aquifers. In central Reeves County, the section encounters a bounding fault where the Rustler is at a higher elevation to the east and is nearly disconnected to the west. Near the Pecos County boundary, the section encounters the graben which overlies the Capitan Reef on the eastern side of the basin. The Rustler Formation is completely disconnected on both sides of the graben. On the eastern side of the graben, the Rustler Formation thins eastward.

Figure 2.2.6 shows cross-section C-C', which originates in southern Pecos County in the Glass Mountains and extends across Pecos County into the graben associated with the Capitan Reef

and then approximately at the Ward County line the section climbs out of the graben and onto the Central Basin Platform. The southernmost portion of this section, not unlike much of this region, attracts some debate as to the geology (see Hill, 1999). However, several investigators have defined the Tessey Limestone as a facies equivalent to the Rustler and Salado formations (King, 1937). Moving from the highlands to the northeast into the southern extent of the graben, the section encounters two faults that successively lower the Rustler Formation (or equivalent) section. Moving northeast towards the Pecos River and the Ward County line in the graben, the Rustler Formation gets deeper and deeper until it encounters the eastern fault bounding the graben to the east. At this fault, the Rustler Formation is completely disconnected by nearly 800 feet vertically.

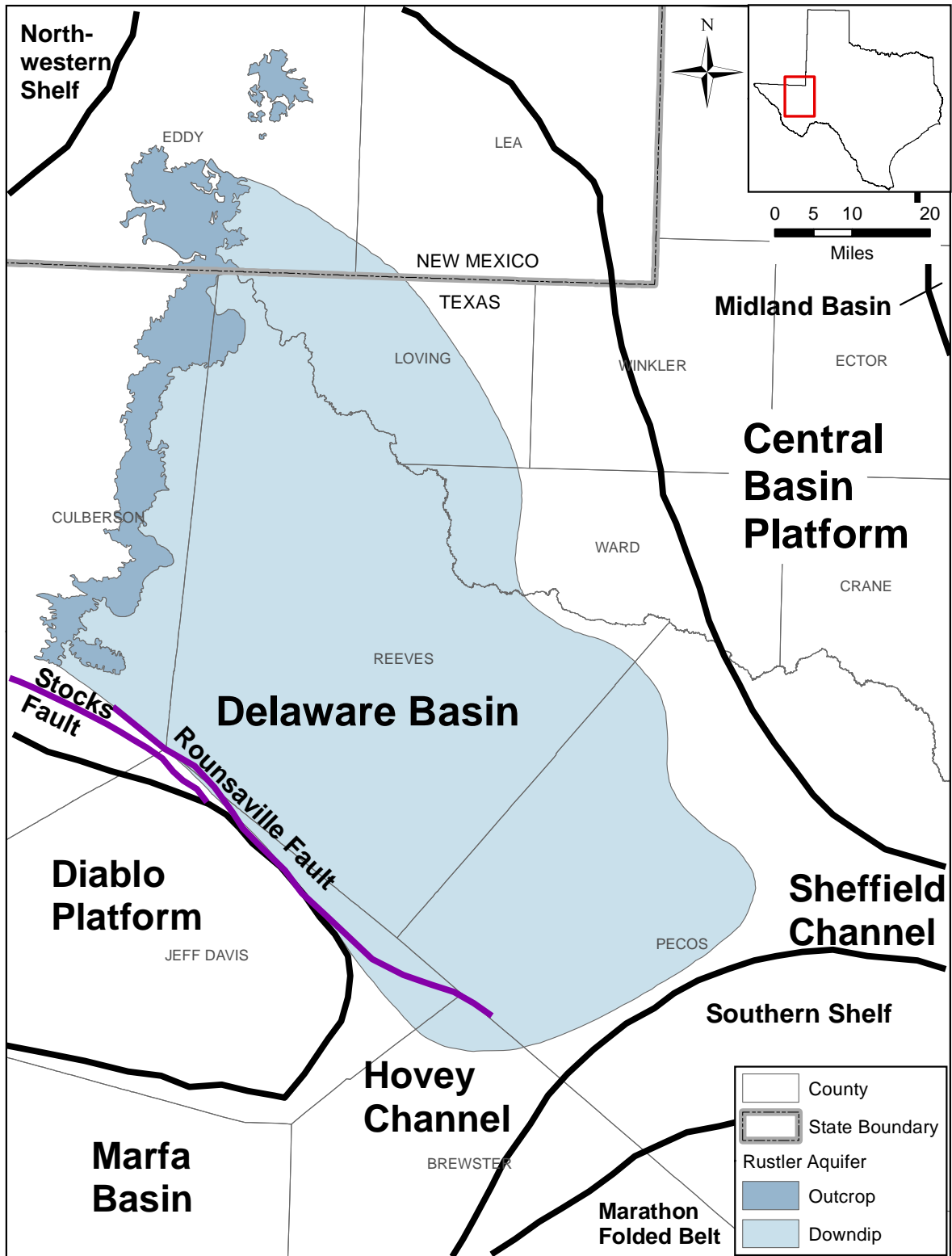

Figure 2.2.1 Major structural features in the study area (after Armstrong and McMillion, 1961; Sharp and others, 2003).

Final Groundwater Availability Model for the Rustler Aquifer

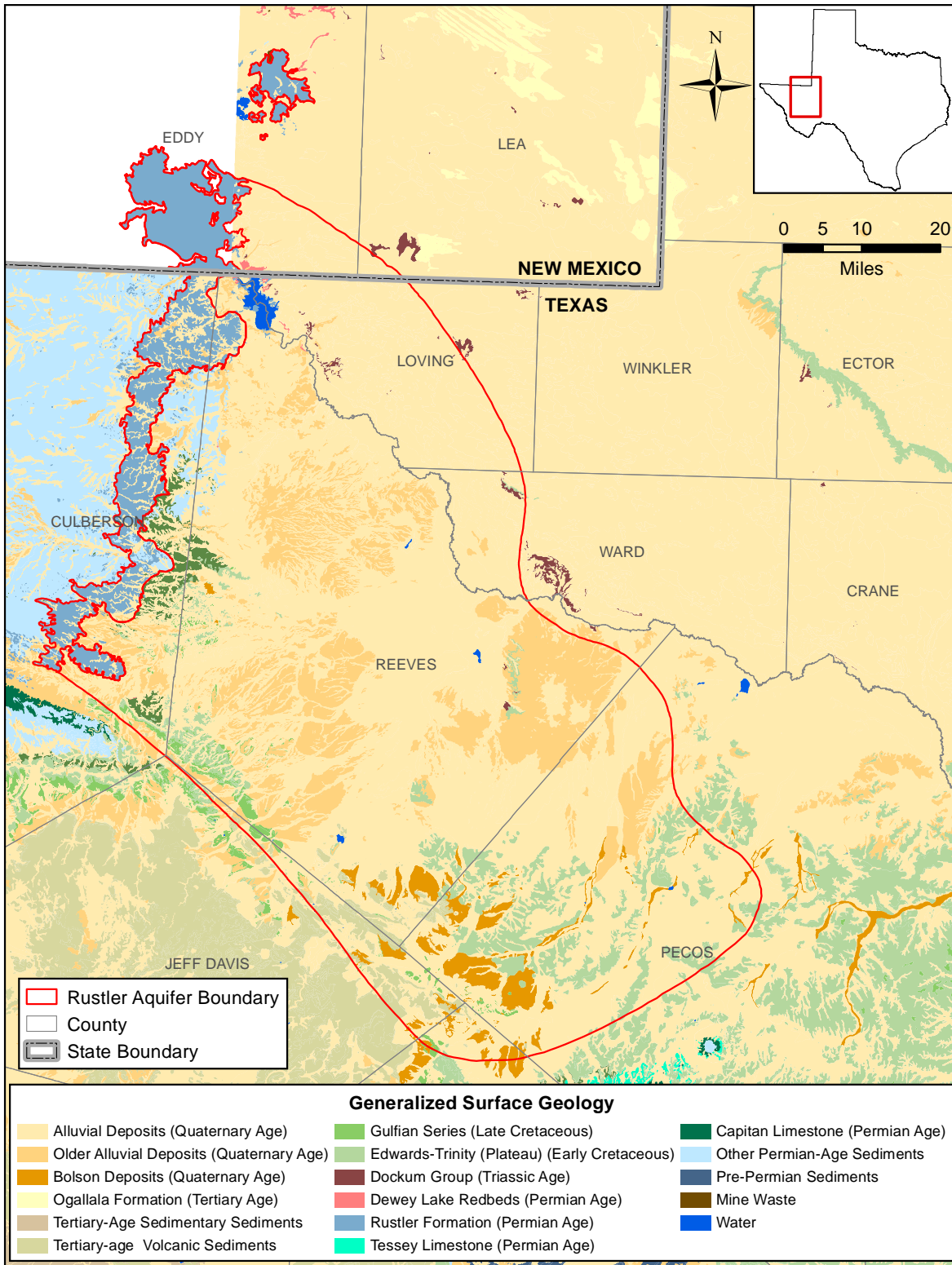

Figure 2.2.2 Generalized surface geology in the study area (United States Geological Survey – Texas Water Science Center and the Texas Natural Resource Information Center, 2004).

System	Culberson and Reeves Counties, TX		Pecos County, TX/ Glass Mountains	Central Basin Platform		
Quaternary/ Tertiary		Pecos Alluvium	Alluvium Volcanics	Alluvium		
Cretaceous	Edwards-Trinity (Plateau)		Edwards-Trinity (Plateau)	Edwards-Trinity (Plateau)		
Triassic		Dockum	Dockum	Dockum		
Permian	Dewey Lake		Dewey Lake	Dewey Lake		
	Rustler	Forty-Niner	Rustler	Upper Member	Rustler	Upper Member
		Magenta Dolomite		Middle Member		Basal Member
		Tamarisk		Lower Member	Tessey Limestone	
		Culebra Dolomite		Lower Member		
Lower Gypsum & Mud Siltstone						
	Salado		Salado	Salado		

Figure 2.2.3 Generalized stratigraphic column for the Rustler Formation and overlying and underlying formations.

Final Groundwater Availability Model for the Rustler Aquifer

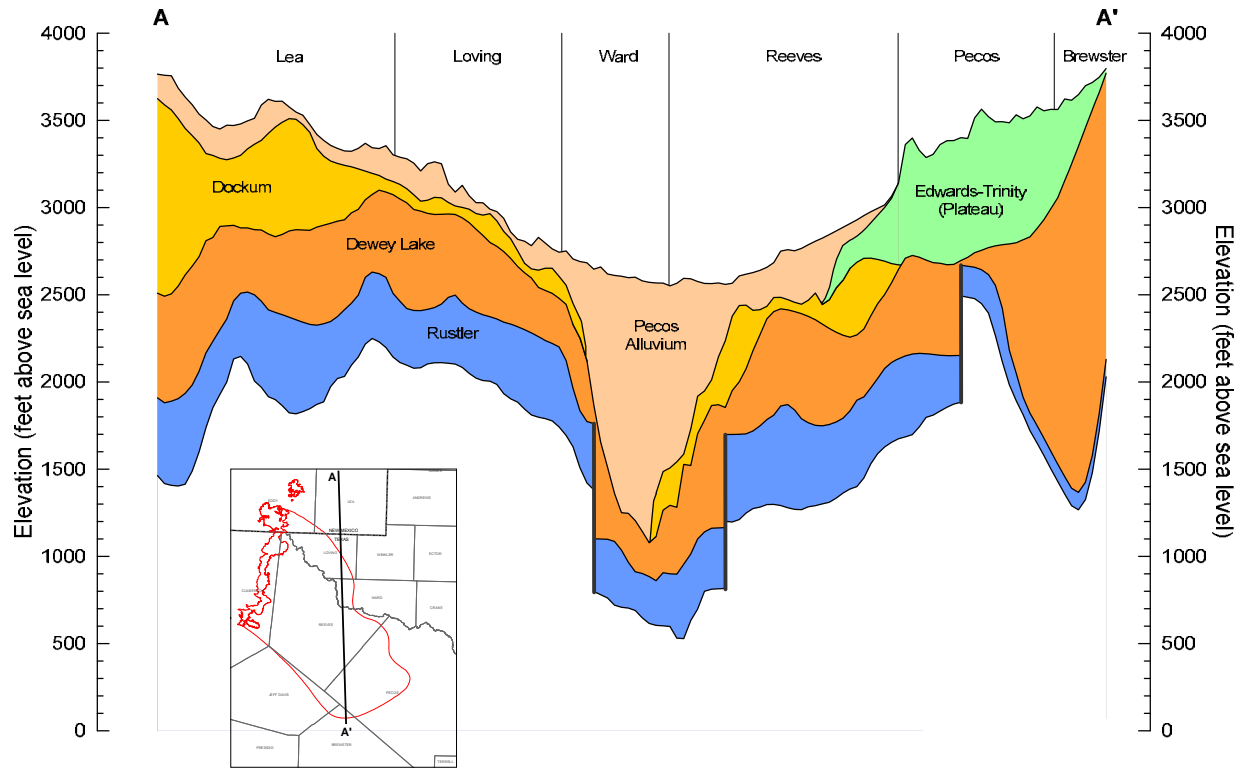

Figure 2.2.4 A-A' north-south cross-section extending from Lea County, New Mexico into Brewster County, Texas.

Final Groundwater Availability Model for the Rustler Aquifer

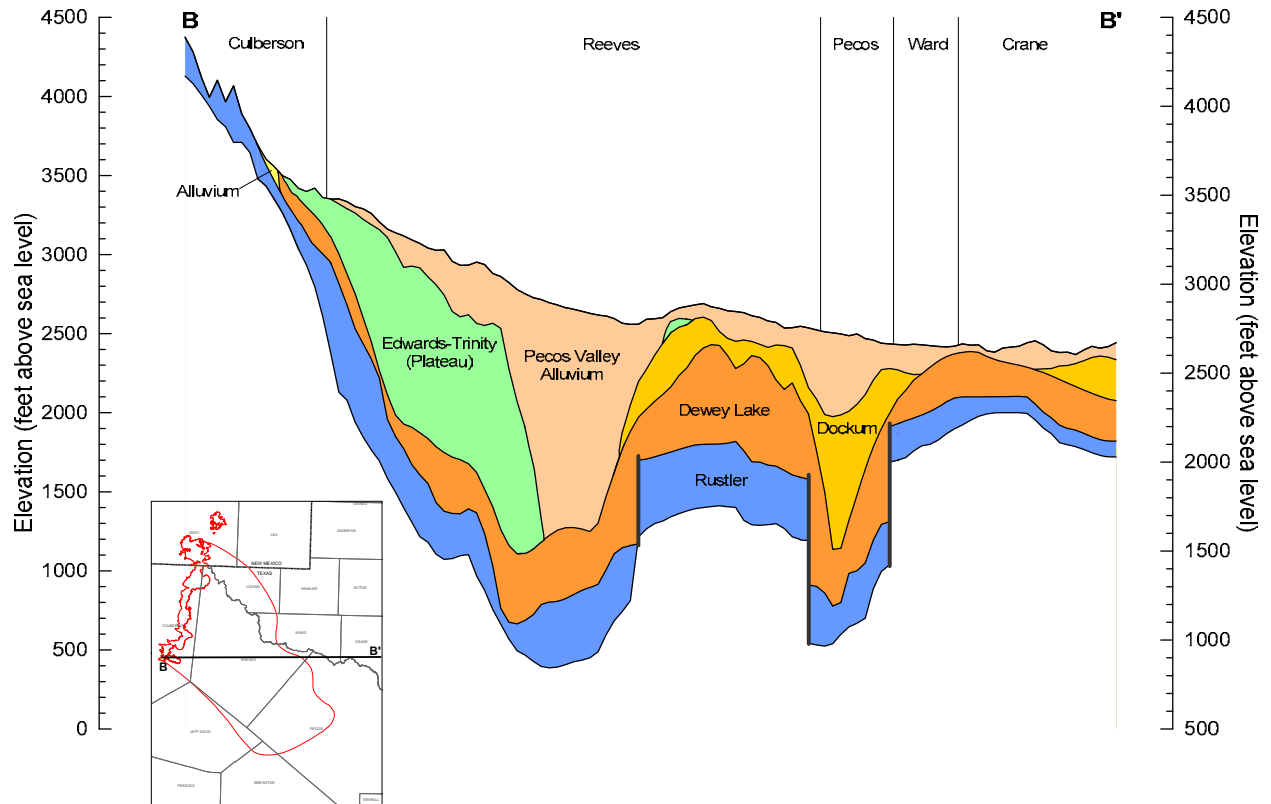

Figure 2.2.5 B-B' east-west cross-section extending from the Rustler Aquifer outcrop in Culberson County into Crane County.

Final Groundwater Availability Model for the Rustler Aquifer

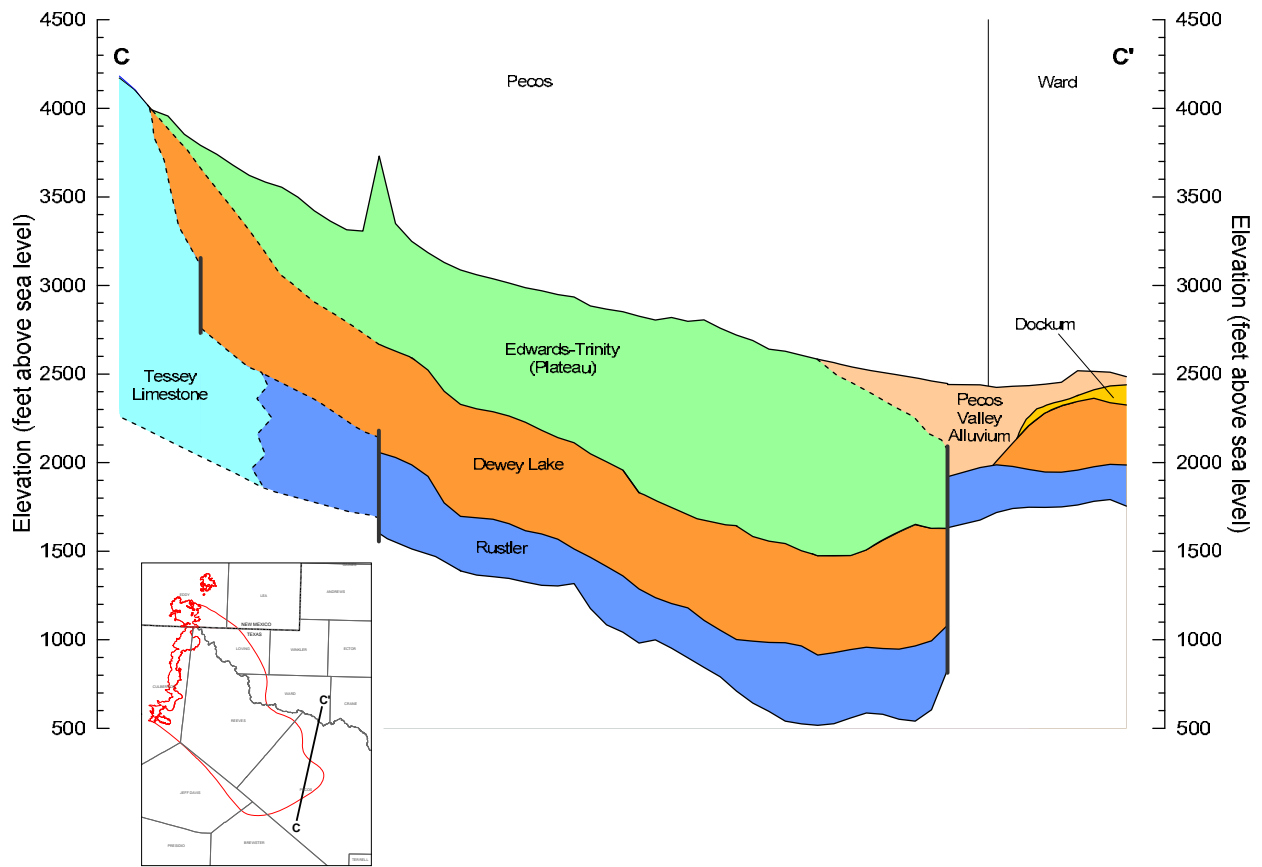

Figure 2.2.6 C-C' southwest-northeast cross-section extending from the Glass Mountains into Ward County.

3.0 Previous Investigations

In Texas, most study of the Rustler Formation has been focused on either stratigraphy or the sulfur industry (which is largely proprietary data). Little study or emphasis has been put on the study of the Rustler Formation as an aquifer. This is largely because in many areas of Texas far higher quality and quantity of groundwater can be retrieved from shallower units. Because of the study and siting of the Department of Energy Waste Isolation Pilot Plant (WIPP) in southeastern New Mexico, significant characterization of the Rustler Formation has been documented over the last three decades. This is because the Culebra Dolomite Member of the Rustler Formation is considered to be the most likely off-site pathway in the event of a breach in the repository. This section provides a brief summary of the Texas investigations available to the public as well as a brief description of some of the more relevant research performed as part of the WIPP site investigations.

The lithology of the Rustler Formation has been described by Richardson (1904), who named the formation from outcrops near Rustler Springs in the Rustler Hills of Culberson County. While some other early workers (Porch, 1917; Lang, 1935, 1937; Adams, 1944) described some aspects of the formation, it was Vine (1963) who clearly defined five members in the formation based on work in the northern Delaware Basin in support of Project Gnome, which was the first underground nuclear detonation conducted by the United States with the objective of peaceful applications. The structure of the top of the Rustler Formation in southeast New Mexico and west Texas was first comprehensively developed and described by Hiss (1976), following earlier work by Maley and Huffington (1953). Hiss (1976) found that the top of the Rustler Formation generally slopes irregularly to the east but this regional trend is interrupted by numerous local collapse features caused by the dissolution of underlying older Permian strata. Hiss (1976) described lens-shaped troughs in two areas which he named the Balmorhea-Pecos-Loving trough, extending from Balmorhea, Texas to Loving, New Mexico, and the Belding-San Simon trough, extending from Belding, Texas through to the San Simon Swale in New Mexico. The location of these troughs is shown on Figure 3.0.1. These troughs were not included on the figure showing major structural features (see Figure 2.2.1) for reasons discussed in Section 4.2.

Hill (1996) includes a discussion of the Rustler Formation in her work on the geology of the Delaware Basin, and Guadalupe, Apache, and Glass Mountains in New Mexico and west Texas. Her work had several purposes including integrating the information from various geologic disciplines and from various regions in the basin into a meaningful whole. Hill (1996) describes the stratigraphy, hydrology (predominately from WIPP investigations), groundwater chemistry, and sulfur and potash resources of the Rustler Formation.

A good discussion of the hydrogeology of the Rustler Aquifer is found in Boghici and Van Broekhoven (2001). They provide information on the regional geologic setting, structure, properties, potentiometric surface, recharge, discharge, water availability, and groundwater geochemistry of the Rustler Aquifer.

Several reports written by various past and present Texas state agencies responsible for water resources include a discussion of the Rustler Aquifer. The Rustler Aquifer is not the focus of any of these reports because it provides small amounts of groundwater compared to the primary aquifers discussed. A very brief description of the Rustler Aquifer is provided by Ashworth (1990) in his evaluation of groundwater resources in parts of Loving, Pecos, Reeves, Ward, and Winkler counties, Texas and in Rees (1987) in his record of wells, water levels, pumping, and chemical analyses from selected wells in parts of the Trans-Pecos region of Texas. A discussion of the quality of groundwater in the Rustler Aquifer is provided in Texas Water Commission (1989). A discussion of the Rustler Formation, including development of water supplies, water quality, and natural discharge to overlying formations, is provided by Armstrong and McMillion (1961) in their report on the geology and groundwater resources of Pecos County, Texas. They also provided a record of Rustler Formation wells in Pecos County, chemical analyses of several samples of groundwater in the Rustler Formation, and describe a fault system near the city of Belding. The Rustler Formation in Reeves County is described in Knowles and Lang (1947) and Ogilbee and others (1962). In addition to a discussion of the formation, records of wells completed into the Rustler Formation and analyses of groundwater samples collected from the formation are provided in these two reports. White (1971) provides a discussion of the Rustler Formation, including structural top, lithology, hydrology, hydraulic properties, water use, water quality, and records of wells, for Ward County, Texas. The Rustler Formation in Winkler County, Texas is briefly discussed in Garza and Wesselman (1959). They also include records

for wells completed into the Rustler Formation and results of chemical analyses on groundwater from the Rustler Formation.

United States Geological Survey reports by Hood and Kister (1962), Richey and others (1985), and Small and Ozuna (1993) also provide discussions of the Rustler Formation. In their report on saline water resources in New Mexico, Hood and Kister (1962) include a brief discussion of the Rustler Formation and include a listing of several saline water wells completed into the Rustler Formation. Richey and others (1985), in their report on the geohydrology of the Delaware Basin and vicinity in Texas and New Mexico, include a discussion of the structure, thickness, groundwater occurrence, groundwater use, recharge, discharge, aquifer test data, and water quality of the Rustler Formation. They also include water-level measurements in Rustler Formation wells and results of analyses of water sampled from selected wells completed into the Rustler Formation. A brief description of the Rustler Aquifer is provided by Small and Ozuna (1993) in their report on groundwater conditions in Pecos County, Texas, 1987.

Veni (1991) performed an unpublished study for the Nature Conservancy of Texas on the delineation and hydrogeology of the Diamond Y Springs system located in Pecos County, Texas northwest of the city of Fort Stockton (see Figure 3.0.1). While this study could not be obtained by the authors, it is reported in Boghici (1997) that Veni (1991) proposed that the source of the Diamond-Y Springs complex was the Capitan Aquifer System based upon his analysis of sodium/chloride and calcium/magnesium ratios. His conclusion was that the source water at Diamond Y was the product of halite dissolution and subsequent flow through a dolomite. The research of Boghici (1997) came to a slightly different conclusion in that he concluded that the groundwater from the Rustler Aquifer probably accounts for most of the discharge at Diamond Y Springs. Boghici (1997) performed an investigation into the source of water at the Diamond Y Springs system. His study combined water quality and isotopic data. He determined that heads in the Rustler Aquifer show flow converging in the area of Diamond Y Springs. He concluded that there were two Rustler chemical facies, one he termed “fresh” and one termed “saline” that he could demonstrate could be responsible for spring water chemistry if assumed to be chemical mixing end members. Boghici (1997) showed that the mixing of the two end member types of groundwater in the Rustler Aquifer and evaporation of spring flow could produce the water chemistry observed in discharge from the Diamond Y Springs system. His study was limited in

that it only assumed two-end member mixing limited to the Rustler while the Diamond Y fault system must intersect the Edwards-Trinity (Plateau) Aquifer and has the potential to connect to formations deeper than the Rustler Formation. Whatever the potential limitations, the study was very valuable in that it clearly shows that the Rustler Aquifer is contributing flow to the Diamond Y Springs system.

Boghici (1997) also developed a two-dimensional numerical model of the Edwards-Trinity (Plateau) Aquifer in Pecos County as part of his research. The general purpose of his modeling efforts was to look at the potential focused discharge that may occur from the Rustler Aquifer to the Edwards-Trinity (Plateau) Aquifer in Pecos County. Boghici (1997) had identified two fault systems that he thought allowed focused discharge for the Rustler Aquifer. One system, described by Armstrong and McMillion (1961), is located in the Belding area. The other system, identified by Boghici (1991), is located in the Diamond Y Springs area (see Figure 3.0.1). Although his model did not directly include the Rustler Aquifer, it provides important information on natural discharge from the aquifer. He calibrated his model with approximately 3,800 acre-feet per year of Rustler Aquifer inflow to the Edwards-Trinity (Plateau) Aquifer near Belding and approximately 260 acre-feet per year of flow presumably to the Diamond Y Springs as a subcrop spring. Using descriptions of the model domain given in Boghici (1997), approximate boundaries for his model were developed and are shown in Figure 3.0.2.

Brown (1998) provides an evaluation of the quality of groundwater in the Rustler Aquifer. He discusses the total dissolved solids concentration, major anion and cation concentrations, nutrient concentrations, and radioactivity of groundwater in the Rustler Aquifer based on the analysis of samples from 18 wells collected from 1990 to 1995. Brown (1998) also compares his results with those from earlier studies for concentrations of chloride, fluoride, sulfate, and total dissolved solids and for hardness.

The research of Boghici (1997) referenced above is part of a large body of research that focused on the hydrogeology of the Trans-Pecos area of Texas performed by geology students studying under Dr. John Sharp at the University of Texas in Austin over the past 25 years (Nielson and Sharp, 1985; LaFave, 1987; Schuster, 1996; Boghici, 1997; Uliana, 2000). Like most studies in the area, the Rustler Aquifer was not the focus of any of these investigations with the exception

of Boghici (1997). The strength of all these studies is that they have done a good job of integrating geochemistry, geology, and hydrogeology to understand groundwater flow patterns in the region. Through this research, the hydrogeology, hydrochemical facies and origins of spring flow, and conceptualization of regional flow systems in the Trans Pecos area of Texas has been further developed. Synthesis of these studies are presented in Sharp (2001), Uliana and Sharp (2001), and Sharp and others (2003). Their conclusions regarding the Rustler Aquifer are specific to the origin of the Diamond Y Springs, which they conclude is sourced, at least in part, from groundwater in the Rustler Formation discharging through a deep-seated fault system. These studies also provide further conclusions that potential far-field regional flow systems occur within the Cretaceous, and potentially the Permian, carbonates from the Diablo Plateau-Apache Mountains and Wild Horse Flat area and extend into Reeves and possibly Pecos counties. Uliana (2001) and Uliana and Sharp (2001) document hydrochemical facies used in conjunction with geologic fault orientation information and hydraulic heads to conclude that a regional flow system may occur which parallels the Jeff Davis-Reeves county boundary through an extensive fault system comprised of the Stocks and Rounsaville Faults. Their work would suggest that flow could occur from the Apache Mountains through to the Toyah Basin in Reeves County and potentially as far as Pecos County. Most of the chemical or water-level data supporting these groundwater flow pathways are comprised of data in units Cretaceous-age or younger. However, the potential may exist for lateral inflow from the south into the Rustler Aquifer from this flow system. Sharp and others (2003) also propose a regional flow system in the Cretaceous limestones extending from the Glass Mountains to the south, north to Comanche Springs through what they refer to as the Belding-Coyanosa trough, which is similar to the southern end of Hiss' (1976) Belding-San Simon trough.

Unlike the Rustler Formation in Texas, the formation in the vicinity of the WIPP site located in Eddy County, New Mexico has had extensive study for over three decades. This is because the Culebra Dolomite Member of the formation is viewed to be the most likely migration pathway from the repository site in the event of a breach. In addition to a tremendous amount of characterization activities, there have been several numerical models developed to simulate groundwater flow in the Culebra Dolomite Member in the near vicinity of the site (D'Appolonia Consulting Engineers, 1981; Barr and others, 1983; Haug and others, 1987; LaVenue and others, 1990; Davies, 1989; United States Department of Energy, 1996, 2004, 2009). Because of the

large number of models and the fact that none extended into Texas, only the boundary for the most recent modeling effort performed for the 2009 compliance recertification application (United States Department of Energy, 2009) is shown on Figure 3.0.2. Although this model does not extend into Texas and does not include the entire Rustler Formation, it is important because it provides information on flow into the Rustler Aquifer from the north.

One modeling study performed in association with the WIPP site did model the entire Rustler Formation as well as the overlying Dewey Lake Formation and Triassic units. This modeling study took a more basinal approach and was aimed at improving the conceptual understanding of post-Pleistocene hydrology and the impact of climate change on groundwater flow and direction of flow within the Rustler Formation (Corbet and Wallace, 1993; Corbet and Knupp, 1996; Corbet, 2000). The boundary for that model is shown on Figure 3.0.2. They used a three-dimensional model to simulate 14,000 years in the past, when the climate in southeastern New Mexico was cooler and wetter than the current climate, to 10,000 years into the future to evaluate changes in groundwater flow patterns in the Culebra Dolomite Member due to changes in climate.

Most recently, a study of the hydrogeology and geochemistry of the aquifers in the Leon-Belding Area was completed by Harden and others (2011) to support new production permits for wells in the area under regulation by the Pecos County Underground Water Conservation District. This model was a revision of an earlier model developed for Fort Stockton Holdings by the Thornhill Group (2008). The focus of this study and the associated modeling was the Edwards-Trinity (Plateau) Aquifer, but the model did include the Rustler Aquifer as part of a Permian system model layer. The extent of this model is shown on Figure 3.0.2.

The groundwater availability model (GAM) documented here presents the first numerical model focused on the Rustler Aquifer in Texas.

Final Groundwater Availability Model for the Rustler Aquifer

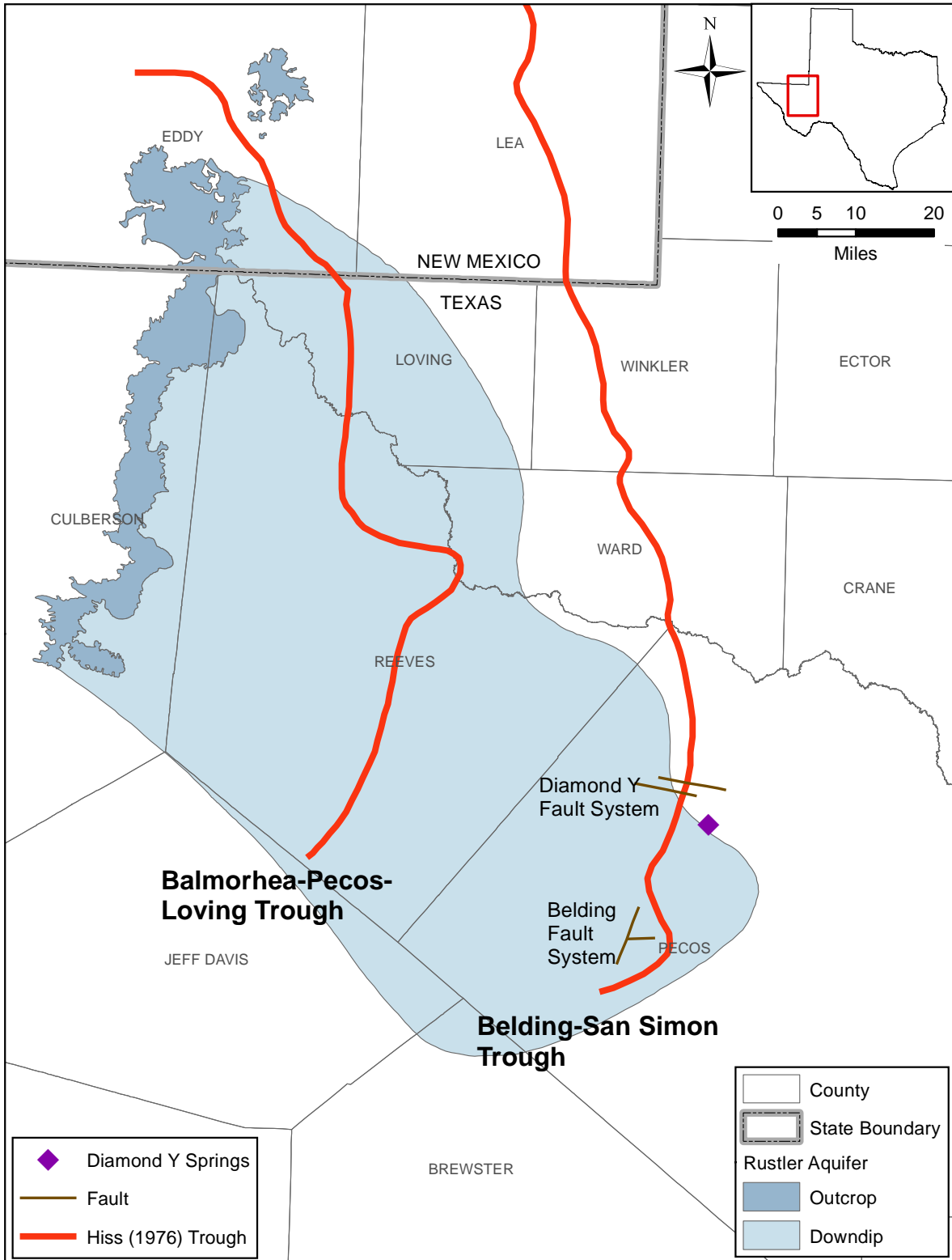

Figure 3.0.1 Troughs identified by Hiss (1976) and faults given in Armstrong and McMillion (1961) and Boghici (1997).

Final Groundwater Availability Model for the Rustler Aquifer

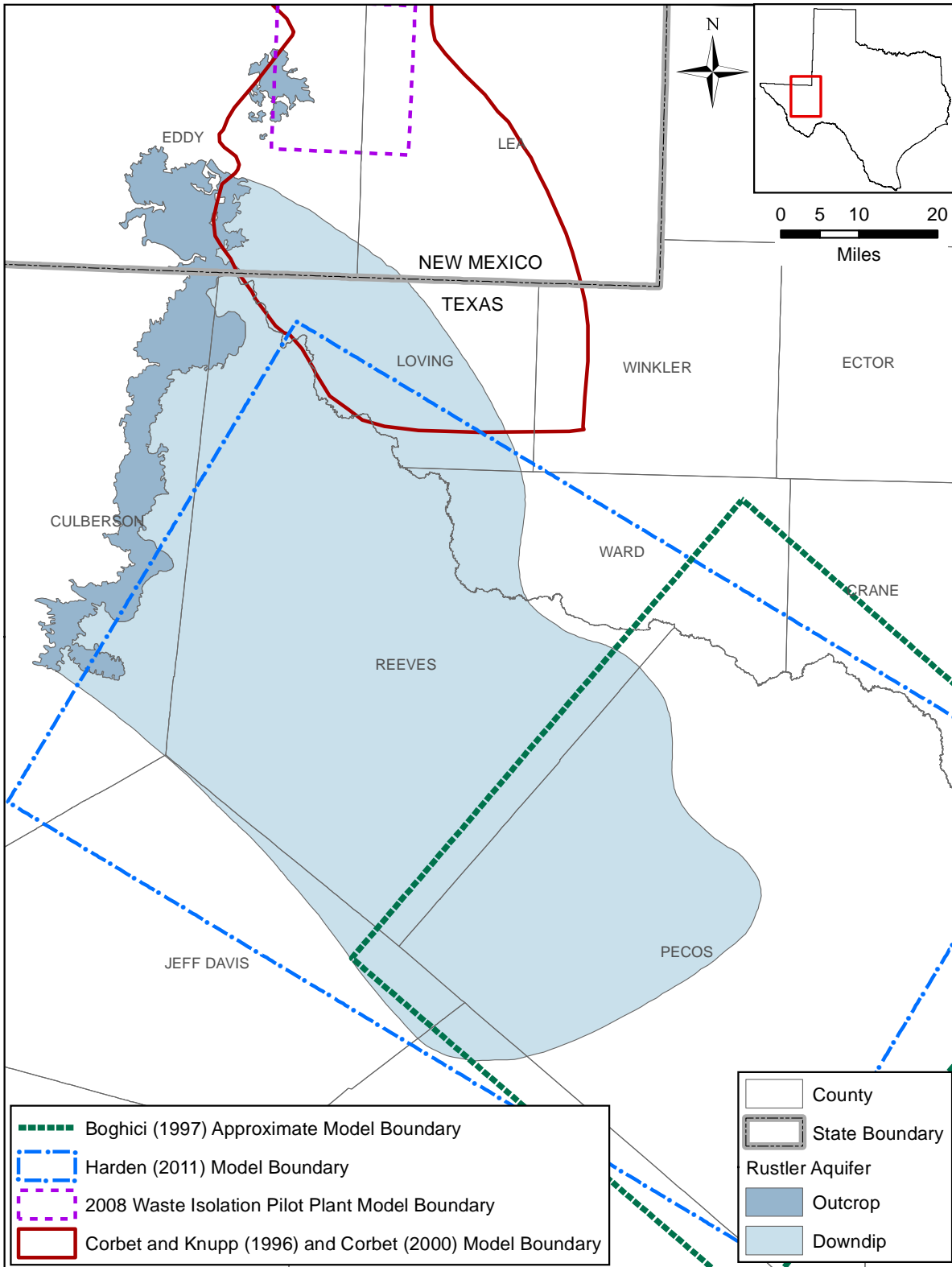

Figure 3.0.2 Locations of boundaries for previous modeling studies that considered the Rustler Formation (Corbet and Knupp, 1996; Boghici, 1997; Corbet, 2000; Harden, 2011).

4.0 Hydrogeologic Setting

This section details the data compilation and analyses used to support development of the conceptual model for the Rustler Aquifer. This information, in total, is referred to as the hydrogeologic setting and includes a discussion of the hydrostratigraphy, structure, water levels, recharge, surface water-aquifer interaction, discharge, hydraulic properties, and water quality of the aquifer.

4.1 Hydrostratigraphy

The Rustler Aquifer is located in the Trans-Pecos region of Texas and consists of the portion of the Rustler Formation containing groundwater having a total dissolved solids concentration of less than 5,000 milligrams per liter (Boghici and Van Broekhoven, 2001). The Permian-age Rustler Formation was deposited throughout the Delaware Basin, across the Central Basin Platform, and into the Midland Basin.

4.1.1 Stratigraphy

The outcrop of the Rustler Formation, which consists of dolomite, dolomitic limestone, limestone breccia, gypsum, and mudstone with minor siltstone and sandstone near the base (Hentz and others, 1989), is located in Rustler Hills in Culberson County. In general, a sequence of anhydrite and gypsum with interbedded dolomite makes up the upper portion of the formation and primarily clastics make up the lower portion of the formation (Hiss, 1976). Locally, minor amounts of salt and limestone occur in the formation (White, 1971). The number of recognized members of the Rustler Formation and the lithology of those members varies from west to east as shown in Table 4.1.1.

Richardson (1904) described and named the Rustler Formation from outcrops near Rustler Springs in the Rustler Hills of Culberson County, Texas (see review in Powers and Holt, 1999). While some other early workers (e.g., Porch, 1917; Lang, 1935, 1937; Adams, 1944) described some aspects of Rustler Formation geology, it was Vine (1963) who clearly set out five members to the formation based on work in the northern Delaware Basin near Carlsbad in support of Project Gnome, which was the first underground nuclear detonation conducted by the United

States with the objective of peaceful applications. Poor exposures of the lower portion of the formation lead Vine (1963) to informally designate the Rustler Formation below the Culebra Dolomite Member as the “unnamed lower member.” Lucas and Anderson (1994) described outcrops of this interval from Rustler Hills and named it the Virginia Draw Member. They reported this member disconformably overlying gypsum of the Castile Formation, implying that the Salado Formation is absent. Powers and Holt (1999) described well exposed beds of this interval from large-diameter shafts at the Waste Isolation Pilot Plant (WIPP) site and named it the Los Medaños Member. They reported consistent stratigraphic relationships with the underlying Salado Formation in the eastern Delaware Basin. In the region of the WIPP site in southeastern New Mexico, the Rustler Formation has been further subdivided into several informal units because of the excellent exposures in large-diameter shafts at the WIPP site, multiple cores through various Rustler Formation intervals, and a large number of geophysical logs for correlation (Holt and Powers, 1988). These informal units have helped support interpretations of depositional environments for the Rustler Formation discussed in Section 4.1.2.

In the Delaware Basin and the Central Basin Platform, the Rustler Formation unconformably overlies the Permian-age, halite-rich Salado Formation. Along the western margin of the Central Basin Platform, the Salado Formation is absent in some areas and the Rustler Formation overlies portions of the Permian-age limestone and dolomite deposits of the Capitan Reef Complex (Richey and others, 1985). Discharge from the Capitan Aquifer into the Rustler Aquifer may occur north of the city of Fort Stockton in Pecos County (Veni, 1991). Through geochemical analyses, Boghici (1997) attributed flows to Diamond Y Springs (see Figure 3.0.1) to groundwater discharge from the Rustler Formation.

The Rustler Formation is overlain by a wide range of formations/aquifers in the Delaware Basin including the Permian-age Dewey Lake Formation, the Triassic-age Dockum Aquifer, the Cretaceous-age Edwards-Trinity (Plateau) Aquifer, and the Cenozoic-age Pecos Valley Aquifer. In eastern Culberson County and western Reeves County, the Dewey Lake Formation is absent and the Pecos Valley Aquifer directly overlies the Rustler Aquifer to the north (Ogilbee and others, 1962) and the Edwards-Trinity (Plateau) Aquifer overlies the Rustler Aquifer to the south (Knowles and Lang, 1947). The Rustler Formation is overlain by the Edwards-Trinity (Plateau) Aquifer in northeastern Pecos County and by the Dockum Aquifer in the rest of the county

(Boghici, 1997). Groundwater in the Rustler Aquifer likely discharges to the Pecos Valley Aquifer in north-central Pecos County (Armstrong and McMillion, 1961) and in Reeves County (Richey and others, 1985; Jones, 2001, 2004). Discharge from the Rustler Aquifer into the Edwards-Trinity (Plateau) Aquifer likely occurs in southwestern Reeves County (Knowles and Lang, 1947; Ashworth, 1990), northeastern and west-central Pecos County (Barker and Ardis, 1992), and north-central Pecos County (Rees and Buckner, 1980). Bush and others (1994) state that several aquifers overlying and underlying the Edwards-Trinity (Plateau) Aquifer, including the Rustler Aquifer, are the probable source of the sulfate and chloride hydrochemical facies water characterizing much of the Edwards-Trinity (Plateau) Aquifer in Reeves and western Pecos counties. The source of brackish water in the Edwards-Trinity (Plateau) Aquifer in western Pecos County is due to the mixing of groundwater in the Rustler Formation and the Edwards-Trinity (Plateau) Aquifer according to Boghici (1997).

4.1.2 Rustler Sedimentology, Depositional Environments, and Post-Depositional Alteration

Investigations into the geologic and hydrogeologic nature of the Rustler Formation in southeastern New Mexico, in association with WIPP site characterization studies, have shown that depositional environments, diagenesis and post-depositional alteration of the Rustler Formation and the underlying Salado Formation impact hydraulic properties of the Rustler Formation and can be used as a proxy to predict formation transmissivity (e.g., Holt and Powers, 1988; Powers and others, 2003, 2006; Holt and others, 2005). Some general features of depositional history and environments of deposition are discussed briefly as support for evaluation of hydraulic properties (see Section 4.6) and the model domains (see Section 5.0) that are affected by them.

There are three general patterns in the Rustler Formation that are relevant to hydraulic characteristics. The first is that the Rustler Formation thickness is greatest in the eastern part of the Delaware Basin. Facies of the formation (e.g., Holt and Powers, 1988; Powers and Holt, 2000) show that this is a depositional center (depocenter) that is discernible for three of the five Rustler Formation members (the Los Medaños, Tamarisk, and Forty-niner members). For these three members, the depocenter commonly hosted saline or halite pans, accumulating varying thicknesses and purity of halite. Away from the depocenter, especially to the north and west

within the study area, the halite or saline pan shallowed and the environments were transitional margin deposits. Farther from the margin, subaerially exposed saline mudflat to mudflat environments are important. The bedded halite deposits are related to extremely low transmissivity based upon studies of the Culebra Dolomite Member (Holt and others, 2005; Powers and others, 2006). Study of the Rustler Formation related to characterization of the WIPP site in southeastern New Mexico has shown that the transmissivity of the Culebra Dolomite Member, the most transmissive member of the formation in the area, decreases (and is negligible) where halite is present in the formation members bounding the Culebra Dolomite Member (Powers and others, 2003, 2006; Holt and others, 2005). Where halite occurs in the bounding members, porosity in the Culebra Dolomite Member is occluded by halite and sulfate (Powers and others, 2006). Therefore, a relationship exists between the transmissivity of the Culebra Dolomite Member and the current presence of halite in the bounding members. The observed pressures in the formation above hydrostatic pressure and the presence of halite indicate a lack of water movement into these portions of the formation, further evidence of a low transmissivity. By extension, the transmissivity in other parts of the Rustler Formation is expected to be very low where bedded halites or halite cements are found within the formation. In areas with less halite, a higher transmissivity for the Rustler Formation is expected.

The second general pattern is that all members of the Rustler Formation are regionally extensive and continuous to the north, east, and southeast beyond the general hydrologically significant area of the formation in this study. Along the west, the Rustler Formation outcrops include mostly the lower part of the formation, mainly the Culebra Dolomite and Virginia Draw (generally similar to the Los Medaños) members. In most Rustler Formation outcrop areas, the upper portion of the formation has been eroded. In addition to the members being regionally extensive and continuous, most of the larger informal beds of the Rustler Formation (Holt and Powers, 1988) can be identified through much of the study area. Especially to the east and southeast of the study area, the Forty-niner and Magenta Dolomite members tend to become thinner, and the Culebra Dolomite Member is no longer distinctive or lithologically a dolomite. In the southern part of the study area, the Los Medaños Member includes more dolomite (e.g., Eager, 1984).

A third gross pattern is that major secondary alteration is commonly related to exposure of the Rustler Formation or erosion that brought the formation near to the surface. One process that is related to such exposure (or removal of overburden) is the subsrosion (solution) of upper Salado Formation halite (e.g., Powers and others, 2003, 2006; Holt and Powers, 2010). Studies in the northern portion of the study area show that the solution margin of the upper Salado Formation is relatively distinctive and can cause a marked topographic margin. This solution process is found to increase the transmissivity of the Culebra Dolomite Member, and the formation as a whole is likely affected. While this analysis cannot be done in the detail necessary to define such a margin on subsurface data, the margin of this solution process has been estimated using topographic features so that an appropriate factor can be assigned in the study area. In addition, bringing the Rustler Formation to the surface or near-surface by erosion also promoted the development of karst features in sulfate and carbonate beds, altering the hydraulic properties. The area affected by upper Salado Formation subsrosion is assumed in this study to be essentially the same as the area in which karst features are more likely to develop or are in the process of forming.

Final Groundwater Availability Model for the Rustler Aquifer

Table 4.1.1 Stratigraphy for the Rustler Formation across the study area.

Culberson and Reeves County, Texas ¹		Pecos County, Texas ¹		Central Basin Platform ²	
Member	Lithology	Member	Lithology	Division	Lithology
Forty-niner Member	two beds of massive and nodular anhydrite and gypsum separated by a thin gypsiferous mudstone or siltstone bed	Upper Member	locally calcareous and oolitic dolomite	Upper Member	anhydrite, salt, and sand with some dolomite
Magenta Dolomite Member	interbedded dolomite and gypsiferous dolomite				
Tamarisk Member	two beds of massive and nodular anhydrite and gypsum separated by a gypsiferous mudstone bed	Middle Member	calcareous siltstone, sandstone, shale, with interspersed anhydrite, gypsum, and shale; locally massive anhydrite and gypsum, and sandy dolomite		
Culebra Dolomite Member	locally brecciated laminated dolomite				
Lower gypsum and mudstone member ³	mudstone and gypsum interspersed with thin gypsiferous dolomite beds	Lower Member	locally calcareous, argillaceous, oolitic, or sandy dolomite	Basal Member	sand, conglomerate and variegated shale
Siltstone member ³	dolomitic siltstone and mudstone in lower part with dolomite at top				

¹ after Boghici and Van Broekhoven (2001)

² Dockery (1989)

³ combined and referred to as the Virginia Draw Member by Lucas and Andersen (1994) and as the Los Medaños Member in New Mexico by Powers and Holt (1999).

4.2 Structure

The groundwater model for the Rustler Aquifer consists of two layers with the upper layer representing the combined Dockum Group and Dewey Lake Formation and the lower layer representing the Rustler Formation. The following paragraphs describe the data sources used to develop the structure and how the structure surfaces were created for these formations. Because the primary structural development effort for the Rustler Aquifer groundwater availability model (GAM) was that for the Rustler Formation itself, additional discussion of the characteristics of the structure for the Rustler Formation are also provided along with a description of structural domains in the Rustler Formation. The following subsections describe (1) development of the structure for the Rustler Formation, (2) development of the structure for the Dockum Group and Dewey Lake Formation, (3) structural characteristics of the Rustler Formation, and (4) structural domains in the Rustler Formation.

4.2.1 Rustler Formation Structure

The Brackish Resources Aquifer Characterization System (BRACS) of the Texas Water Development Board (TWDB) developed a pilot study in the Trans-Pecos area of western Texas to evaluate methodologies, procedures, data deficiencies, and potential problems in the characterization of brackish aquifer systems. As part of this study, they reviewed data from numerous sources including geophysical logs, the TWDB groundwater database, and reports published by the TWDB and predecessor agencies to determine the top elevation for formations in the pilot study area, including the Rustler Formation.

Since the BRACS investigation of the structure for the top of the Rustler Formation was occurring at the same time as this study, an effort was made to maintain consistency between the two data sets. Geophysical logs obtained from the BRACS (Meyer, 2010a), the TWDB's Capitan Aquifer structure project, and the New Mexico Oil Conservation Division were used to determine the top and bottom of the Rustler Formation. In addition, the top of the Dewey Lake Formation was also determined from these data and used to develop a structural surface as discussed in Section 4.2.2.

The structure surfaces for the base and top of the Rustler Formation were constructed mainly using data from geophysical logs, with coarsely estimated contours from outcrop areas. For New Mexico, some of the contouring was influenced by knowledge from additional data sources such as potash exploration and Waste Isolation Pilot Plant (WIPP) site drilling (e.g., Powers and others, 2003, 2006). Because these data sources are not readily available in electronic format for inclusion in this study, the well data were not included or contoured.

Data used were also limited by several qualifications. Source geophysical logs from Meyer (2010a) and the Capitan Aquifer structure project beyond the potential modeling domain were not included. If a geophysical log did not yield a reasonable interpretation of both the top and base of the Rustler Formation, the well was not included. If a well location was clearly wrong and could not be corrected, it was discarded. If a well location and basic data regarding elevation could not be reasonably verified through the New Mexico Oil Conservation Division, Texas Railroad Commission, or University Lands public sources, the data were not included. The large data base, however, is believed to be sufficient for developing the structure and thickness of the Rustler Formation without resorting to extraordinary efforts to include additional well locations.

The most common geophysical log type useful for interpreting Rustler Formation stratigraphy and lithology is the natural gamma log because of the contrast between the low gamma sulfate beds and higher gamma clastics of overlying formations as well as some Rustler Formation interbeds. Although neutron, density, acoustic or sonic, and even resistivity logs are very useful in interpreting the top of the Rustler Formation, they are much less common and rarely available. Therefore, the main interpretation for the top of the Rustler Formation was based on the natural gamma logs.

For the northeastern Delaware Basin, log signatures for the Rustler Formation are highly diagnostic and easily interpreted (Holt and Powers, 1988; Powers and Holt, 2000). The top of the Rustler Formation is marked by a sharp increase in natural gamma upward across the sharp transition from uppermost Rustler Formation sulfate beds of the Forty-niner Member to the fine-grained clastics of the overlying Dewey Lake Formation. The base of the Rustler Formation is also a sharp contact between the predominant halite and subsidiary sulfates of the uppermost

Salado Formation to the clastics of the lower Rustler Formation. The lower Los Medaños Member of the Rustler Formation displays a characteristic high natural gamma bulge low in the member, and natural gamma broadly decreases upward.

The top of Rustler Formation log signatures are good across most of the study area. They differ to the far south, west, and southwest as erosion has removed some of the upper Rustler Formation or shallow subcrops are affected by dissolution and removal of more soluble sulfate beds. There are differences and difficulties with interpreting the Salado-Rustler contact to the southwest, south, and southeast. Two differing factors contribute to this difficulty. First is the fact, noted by many, that the lower Rustler Formation includes additional dolomite beds (e.g., Eager, 1984). These more commonly register as low gamma zones in the lower Rustler Formation. When they are within the more normal gamma “bulge,” they are relatively distinctive. Nevertheless, around the perimeter of the study area, Salado Formation halite has been removed, creating a residue that can be mistaken for lower Rustler Formation clastics. In addition, there appears to be a more clastic-rich zone in the upper Salado Formation in the south to southeastern part of the study area that may converge with the basal Rustler Formation and be included in a basal Rustler Formation interpretation. Because the focus is on hydrostratigraphy, it is beyond the scope of this project to fully resolve these issues. Instead, the best estimate of the Salado-Rustler contact was used. It may include some of the Salado Formation residue or siliciclastic zone and overestimate Rustler Formation thickness modestly. As a residue or siliciclastic zone may have similar hydraulic properties to lower Rustler Formation clastics, this may provide a better estimate of the “aquifer” than a more strict stratigraphic pick.

Once picks for the top of the Rustler Formation and the top of the Salado Formation were completed, these data were hand contoured due to the complex nature of the Rustler Formation structure. The hand contours were then digitized and converted to an ArcGIS shapefile. The hand contouring revealed numerous faults in the structure of both the top and bottom of the Rustler Formation as shown in Figures 4.2.1 and 4.2.2, respectively. These figures show a very complex structure for both the top and bottom of the formation. The collapsed section of the Rustler Formation in Lea County, New Mexico and Ward, Winkler, and Pecos counties, Texas has been interpreted as a dissolution feature by Hiss (1976), who referred to this area as the Belding-San Simon Trough.

The far greater density of data used to develop the structure of the Rustler Formation for this GAM relative to that used by Hiss (1976) suggests that faulting and sharp displacements along at least parts of the collapse feature are warranted. Near the Texas/New Mexico border, displacement across the western side of the feature is about 1,000 feet and displacement across the eastern side of the feature is about 400 feet. Near the confluence of the Reeves, Pecos, and Ward county lines in Texas, displacement is about 300 to 700 feet on both sides of the feature.

Due to the observed displacement, the term graben seems more descriptive for the collapse feature than trough. The term graben is used as a descriptive term for this well-defined structural feature. It is reasonable to interpret the relatively sharp boundaries and displacements as faulting, and the general appearance is of a graben. The term graben is used here as a descriptor and does not imply extension due to tectonics.

While extension due to tectonics is the most common process associated with forming grabens, it is not a necessary process. Dissolution certainly played a major role in the development of the graben. Nevertheless, thickness and stratigraphic data from overlying units across the graben indicate probable tectonic movement along at least the eastern boundary, which is adjacent to the Central Basin Platform, following Rustler Formation deposition. The Dewey Lake Formation shows marked contrast in thickness across the Delaware Basin-Central Basin Platform boundary (Schiel, 1988) along the trends of offsets noted in this study as well as previous studies of the Rustler Formation by Holt and Powers (1988). Across the Central Basin Platform in the northern part of the study area, the upper Dewey Lake Formation found in the Delaware Basin was apparently eroded prior to Dockum Group deposition. These features are consistent with late Permian to early Triassic deformation and faulting along this margin.

Whether the feature is considered or referred to as a trough or graben has some impact on the model. The model explicitly includes the faults on either side of the graben. The model considers the faults as a barrier to flow where the Rustler Formation is completely displaced across the fault. Interpretation of the feature as a trough would not include the barrier but would allow flow into the trough from adjacent portions of the formation.

It appears that there is a relationship between the graben and the Capitan Reef. The graben closely mimics the extent of the defined Capitan Reef although it is slightly narrower to the north

and diverges to the south in the vicinity of the Pecos River. Hiss (1976) states that groundwater flowing northward through the Capitan Reef as a consequence of the uplift of the Glass Mountains dissolved and removed soluble beds in the adjacent Castile Formation and overlying Salado Formation during late Cenozoic time. This dissolution in the Salado Formation resulted in the collapse of the overlying Rustler, Dewey Lake, and Dockum formations.

Development of the Rustler structure identified additional faults (see Figures 4.2.1 and 4.2.2). About 500 to 600 feet of displacement is observed across the faults identified in eastern Reeves County and western Ward County. The faults reported by Boghici (1997) (see Figure 3.0.1) were not identified during contouring of the top and bottom elevations of the Rustler Formation.

The shapefiles created from the hand contours of the top and bottom of the Rustler Formation were used to create an ArcGIS raster data set for the top and bottom of the formation. This was done by converting the contour polylines to points. For the outcrop areas in both Rustler Hills in Culberson County and the Tessey Limestone in Pecos County, the digital elevation model was contoured at the same interval as the subcrop hand contours. The outcrop contours were then converted to points as was done for the subcrop contours. The spline with barriers interpolation method in the ArcGIS Spatial Analyst Toolbox was then used to create a raster of the Rustler Formation with the faults set as the barriers. The resultant rasters are illustrated in Figures 4.2.3 and 4.2.4 for the top and bottom of the Rustler Formation, respectively. These rasters have been cropped to the approximate area of outcrop and control data locations. Although these rasters do not exactly reproduce the hand contours due to the very complex nature of the structure of the Rustler Formation, they do provide a good representation of the Rustler Formation structure. The base and top of the formation were modified to accommodate a minimum formation thickness of 100 feet and a maximum formation thickness of 1,000 feet, respectively (see below).

The thickness of the Rustler Formation was developed by subtracting the raster of the bottom of the Rustler Formation from that of the top of the formation. In a few small areas, a negative thickness was calculated due to inconsistencies between the top and bottom rasters as a result of the numerous faults and differences in hand contour locations between the two structures. To eliminate these negative thicknesses, a minimum Rustler Formation thickness of 100 feet was assumed across the entire formation. Once this modification to the thickness was completed, the

Rustler Formation top surface was assumed to be correct in the areas with a negative thickness and the bottom surface was adjusted downward. In addition, excessively large thicknesses were calculated in small areas with a large distance between a hand contour and a fault where the interpolation scheme yielded a continually increasing top elevation. In those instances, a maximum thickness of 1,000 feet was assumed. Because the interpolated top of the Rustler Formation was inconsistently high in the areas with excessively large thicknesses, the top surface was lowered in these areas. The thickness for the Rustler Formation is illustrated in Figure 4.2.5.

4.2.2 Dockum Aquifer and Dewey Lake Formation Structure

In addition to picking the top of the Rustler Formation, the structure component of the BRACS pilot study also picked the top of the Dockum Group as well as other stratigraphic picks in shallower units (Meyer, 2010b). Those data were used to develop the elevation of the top of the Dockum Aquifer with two modifications. First, for instances where a top of Dockum Group was determined by the BRACS and the top of Dewey Lake Formation was determined as part of the Rustler Aquifer GAM effort for the same geophysical log, the two were compared to verify that the pick for the top of the Dockum Group was above the pick for the top of the Dewey Lake Formation. When this was not the case, the data point was removed from both the Dockum Group data set and the Dewey Lake Formation data set. Second, the top of the Dockum Group was set equal to the top of the Dewey Lake Formation at selected locations along the Dockum Aquifer boundary in order to control the structure along the margins of the aquifer. The modified data set for the top of Dockum Aquifer was kriged using Surfer to obtain structure contours for the elevation of the top of the aquifer. The kriged surface from Surfer was then brought into ArcGIS and converted to a raster dataset. The final elevations for the top of the Dockum Aquifer are illustrated in Figure 4.2.6. These data are cropped to the model boundary for the Dockum Aquifer GAM.

The elevation of the top of the Dewey Lake Formation was developed using the picks for the top of the formation determined as part of the Rustler Aquifer GAM effort. These data were modified in four ways to get the final data set. First, for instances where a top of Dockum Group was determined by the BRACS and the top of Dewey Lake Formation was determined as part of the Rustler Aquifer GAM effort for the same geophysical log, the two were compared to verify that the pick for the top of the Dockum Group was above the pick for the top of the Dewey Lake

Formation. When this was not the case, the data point was removed from both the Dockum Group data set and the Dewey Lake Formation data set. Second, digital elevation model surface elevations were added to the data set where the Dewey Lake Formation outcrops based on the Geologic Atlas of Texas. Third, the Dewey Lake Formation was assumed to be present in the Glass Mountains in southern Pecos County between the outcrop of the Cretaceous Bissett Conglomerate or the Trinity Group and the outcrop of the Tessey Limestone. In that area, ground surface elevations from the digital elevation model were added to the data set of the Dewey Lake Formation. Although the Geologic Atlas of Texas does not show the Dewey Lake Formation at the surface in this area, it lies between the Edwards-Trinity (Plateau) Formation and the Tessey Limestone and was assumed to be covered with a thin layer of surficial alluvial material. Fourth, a large amount of data is available in the Dockum Group data set in southwestern Winkler County that is not available in the Dewey Lake Formation data set. Those data for the Dockum Group show a deep trough that cannot be replicated in the Dewey Lake Formation due to the lack of data. For geophysical logs with both a Dockum Group and Dewey Lake Formation pick from two wells located in that trough, the top of the Dockum Group is approximately 20 feet above the top of the Dewey Lake Formation. In order to force the top of the Dewey Lake Formation below the top of the Dockum Group in this trough, 20 feet was subtracted from the Dockum Group data set in the vicinity of this trough for control points in the Dewey Lake Formation data set.

The modified data set for the top of the Dewey Lake Formation was kriged using Surfer to obtain structure contours for the elevation of the top of the formation. The kriged surface from Surfer was then brought into ArcGIS and converted to a raster dataset. The final elevations for the top of the Dewey Lake Formation are illustrated in Figure 4.2.7. These data are cropped to the western extent of the formation and the approximate extent of the control data. It is likely that the faults in the Rustler Formation extend to some extent into the overlying Dewey Lake Formation. However, verification of that is beyond the scope of the work presented here. These faults are indicated as dashed lines in Figure 4.2.7 and correspond well to significant changes in elevation.

A surface representing the top elevation for the combined Dockum Aquifer and Dewey Lake Formation was created using the Dockum Aquifer data set and the portion of the Dewey Lake

Formation data set located outside of the Dockum Aquifer boundary. The combined data set was kriged using Surfer and then brought into ArcGIS and converted to a raster dataset. The resulting surface represents the top elevation for model layer 1. These elevations were cropped to the western extent of the Dewey Lake Formation and the approximate extent of the control data. The thickness of layer 1 was created by subtracting the raster of the top of the Rustler Formation from the raster of the top of the combined Dockum Group and Dewey Lake Formation. Where the calculated thickness was less than 100 feet, a minimum thickness of 100 feet was assured by raising the top of the combined Dockum Group and Dewey Lake Formation surface. The final surface for the top of model layer 1 was calculated as the top of the Rustler Formation plus the modified thickness of layer 1. The top elevation and thickness for layer 1 are shown in Figures 4.2.8 and 4.2.9, respectively.

4.2.3 Structural Character of the Rustler Formation

Members of the Rustler Formation, as well as informal subunits, are traceable across the study area and beyond to the east, indicating that the area acted more or less as a unit through deposition of the formation. Rustler Formation facies changes (increased halite beds) and thickness increases in the northeastern Delaware Basin indicate that some additional subsidence occurred in the eastern part of the basin during deposition. In addition, marked thickness changes of the overlying Dewey Lake Formation, approximately parallel to the Delaware Basin-Central Basin Platform margin, indicate post-Rustler Formation, pre-Dockum Group displacements down to the west. The northern part of the Delaware Basin was generally above sea level from the end of Rustler Formation deposition and preserves no upper Cretaceous-age or early to mid-Cenozoic-age sediments. Mild tilting to the east of the Delaware Basin occurred with late Cenozoic Basin and Range activity to the west.

The primary tools for describing Rustler Formation structure are the elevation contour map of the top of the formation (see Figures 4.2.1 and 4.2.3) and the Rustler Formation isopach (see Figure 4.2.5). The broader aspects of Rustler Formation structure indicated by these maps are as follows:

- Basin and Range uplift to the west in mid- to late-Cenozoic time superimposed on a general approximately one degree eastward regional dip in the Delaware Basin,

- Localized synsedimentary subsidence in the eastern part of the Delaware Basin, as indicated by thickness changes of the Rustler Formation,
- Synsedimentary to slightly post-sedimentary faulting along the eastern side of the Delaware Basin.

The remaining elements of the complicated local structure are at least partially due to solution of underlying evaporites as well as Rustler Formation evaporites. Individual structural elements of this complicated map are described below.

Areas Related to Regional Dip

There are three main areas that show significant regional dip features (see Figure 4.2.1). Along the western side of the study area, including the outcrop area, contours are inferred from some basic elevation data. They are estimated to be mainly north-south with an eastward dip. The geologic map of the outcrops shows the general north-south trend along a generally consistent elevation. While the top of the Rustler Formation is stratigraphically low in the outcrop due to erosion, it and the base of the formation show a general regional dip, albeit a higher dip closer to the Basin and Range margin along the west. The eastern side of the study area, east of the eastern-most inferred fault, is also consistent with a subdued tilt of the area.

A central corridor located west of the graben shows mostly north-south strike and eastward dip. At the north end of this corridor, an antiformal structure developed over deeper evaporite deformation (Powers and others, 2003). The south end of this corridor is disturbed by faulting and uplift to the south.

Area Showing Synsedimentary Subsidence

A small part of the northern central corridor is an area showing synsedimentary subsidence. The effect of the increased thickness is to flatten out the top of Rustler Formation contours somewhat. While the effects are important because they resulted in increased halite deposition and, therefore, restrict transmissivity, they are otherwise not distinguished from the remainder of the central corridor. The relationship between the presence of increased halite and low

transmissivity is well documented in studies related to characterizing the WIPP site located near Carlsbad, New Mexico (Powers and others, 2003, 2006; Holt and others, 2005).

Areas Showing Post-Depositional Structural Deformation

There are three main subdomains showing post-depositional structural deformation: (1) a graben area trending north-northwest to south-southeast, (2) a west-central area showing deformation attributed mainly to dissolution of the Castile and Salado formations, as well as some Rustler Formation dissolution, and (3) a southern boundary area and faulting between Fort Stockton and Sierra Madera, which is located in the Glass Mountains (see Figure 2.1.3).

The graben mainly overlies the Delaware Basin-Central Basin Platform margin and the margin of the Capitan Reef Complex. The graben is complex. The boundary faults are defined mainly by narrow areas with major relative displacements (hundreds of feet). Faults are extended to areas where displacements do not exist or are small enough to extend contours across the trend of the fault. Because of the highly variable elevations, differing contour solutions could be justified. Hiss (1976) displayed much of the same kind of structure (with fewer data points) and contoured the low points as simple depressions.

The graben (or depression) has been interpreted more commonly as a simple product of subsidence over an area of dissolved salt above the Capitan Reef (e.g., Johnson, 1993). Schiel (1988) mapped the thickness of the Dewey Lake Formation and structure contours of the base and top of the Dewey Lake Formation in southeastern New Mexico. This Dewey Lake Formation thickness markedly changes from much thicker (about 500 feet) to the west to thinner (200 to 300 feet) to the east across this same approximate zone. Structure contours on the base of the Dewey Lake Formation (top of Rustler Formation) show significant elevation differences along the same trend as the eastern graben margin for this study, although based on fewer data points. In addition, the elevation of the top of the Dewey Lake Formation (base of the Dockum Group by Schiel, 1988) shows little or no change related to this trend. The graben and fault trends correspond to the fault zone of Hills (1984) along the western Central Basin Platform margin. The thickness variation of the Dewey Lake Formation and the lack of structural involvement of the base of the Dockum Group are evidence of displacement during Dewey Lake Formation sedimentation or before Dockum Group deposition.

Johnson (1993) also evaluated Salado Formation thickness near the graben area and concluded that syndimentary dissolution had removed some salt thickness. Holt and Powers (2010) also show internal thickness varies in the Salado Formation on the Central Basin Platform. The most likely source of these variations is differential movement of blocks on the Central Basin Platform. It seems highly likely that Permian to early Triassic movement along these faults occurred and is at least a partial explanation of the faulting.

These are also zones of considerable fill along the fault trends (e.g., Bachman, 1981; Johnson, 1993), and it is likely that there has been Salado Formation salt removed. It is not necessary to fully resolve the origins of the graben (or depression). On both sides, the differential elevation across narrow areas indicates little likelihood that the Rustler Formation is hydraulically continuous across the graben.

A west-central area where the Rustler Formation is disturbed generally parallels the Pecos River to just southeast of the town of Pecos and then extends southward. From the northern end to the area around Pecos, the Rustler Formation is fairly shallow (outcrop to about 750 feet), and the Salado Formation shows general evidence of partial dissolution of salt. South of the town of Pecos, however, this zone is less well defined because there are fewer drillholes. The Rustler Formation is also much deeper (about 1,000 to 2,000 feet) south of the town of Pecos.

The southern boundary area is complex both stratigraphically and structurally. Log data are sufficient to indicate considerable displacement and the likelihood of faults. The area farther south is not Rustler Formation. Rather, the Tessey Limestone is a relatively thick unit that crops out around Sierra Madera and along mainly the western flank of the Glass Mountains. It is generally considered to be equivalent to some or all of the Ochoan evaporite units (i.e., Salado and Rustler formations) in the Delaware Basin. Along with the drillhole log data, there is considerable evidence to support faults with large displacements.

4.2.4 Rustler Formation Structural Domains

The general structural character of the Rustler Formation can be subdivided into several structural subregions that are likely important both from a model construction basis and also for model properties and boundaries.

Experience in the Rustler Formation in southeastern New Mexico has shown that several structural and/or post-depositional features of the formation can have an impact on the hydrogeologic properties and, therefore, groundwater flow potential. These observations (Holt, 1997; Powers and others, 2003; Holt and others, 2005) are the subject of discussion in the hydraulic properties section of this report (Section 4.6). The basis for that discussion is provided below through the development of structural subdomains in the Rustler Formation that may represent portions of the formation that have similar hydrologic properties or may represent separate hydraulic domains. These zones are defined by their depth, the presence of faults, and dissolution within the Rustler Formation or the underlying Salado Formation. Figure 4.2.10 shows the structural subdomains developed for the Rustler Formation.

Subdomain 1

Subdomain 1 is located northeast of the Rustler Aquifer in the southeastern end of Lea County, New Mexico and adjacent areas of Texas. It is bounded on the west by displacements on the eastern margin of the graben. This subdomain is characterized by moderate thickness and is dominated by halite and sulfate, with less carbonate. The Rustler Formation in Subdomain 1 is known to be very low in transmissivity, does not contribute to the Rustler Aquifer, and is beyond the model boundary for the Rustler Aquifer GAM.

Subdomain 2

Subdomain 2 is located in Texas, south of Subdomain 1 and east of the bounding fault along the eastern margin of the graben. In this subdomain, the Rustler Formation is thinner, especially to the southeast, and is more sulfatic (i.e., contains more anhydrite). While evidence of halite in the Rustler Formation was found in this subdomain, it was rare and not considered an important factor. This part of the Rustler Formation is also much shallower to the southeast. The presence or extent of upper Salado Formation dissolution remains unassessed in Subdomain 2. In this subdomain, Rustler Formation log signatures, commonly expressed as thicker zones of low natural gamma and high neutron, were interpreted as indicating primarily anhydrite with carbonates (e.g., Culebra and Magenta Dolomite members) poorly expressed, thinner, and possibly absent or represented by facies changes. Although the depth of the Rustler Formation is less in this subdomain, it is estimated to have low transmissivities because of increased anhydrite

(i.e., sulfate minerals) and reduced carbonates. More importantly, the structural displacement along the western subdomain boundary is taken as a hydraulic boundary. This subdomain is unrelated to the Rustler Aquifer as it is described in Texas and is outside the model boundaries.

Subdomain 3

Subdomain 3 is the northern end of the graben. It is bounded by significant displacements on both the east and west sides of the subdomain. While specific evidence of halite is not developed from geophysical log data, it is north of the general boundary of extensive halite in the Rustler Formation. It is also relatively deep (mostly greater than 1,000 ft). This subdomain generally overlies the Capitan Reef. Because of the depth and the probable presence of halite within the Rustler Formation, it is likely a low transmissivity portion of the formation. This conclusion is based on known relationships between extremely low transmissivity of the Culebra Dolomite Member where halite is known to be present in units of the Rustler Formation that bound the Culebra Dolomite Member. These relationships have been observed in southeastern New Mexico through characterization of the WIPP site, which is located near Carlsbad, New Mexico (Powers and others, 2003, 2006; Holt and others, 2005). This subdomain is not considered to be connected to the Rustler Aquifer and was not included in the model.

Subdomain 4

Subdomain 4 is the southern part of the graben and is predominantly in Texas. It is bounded by significant displacements on both the east and west sides of the subdomain, although the eastern boundary displacement decreases to the southeast. The Rustler Formation is deep (greater than 1,000 feet) through almost all of this subdomain, and the Dewey Lake Formation is generally more than 500 feet thick. Much of this subdomain overlies the Capitan Reef. There are common interpretations that the upper Salado Formation has been dissolved along the reef trend (e.g., Hiss, 1976; Johnson, 1993) to drop the overlying formations, including the Rustler Formation. Within this subdomain, the Rustler Formation is commonly between 200 to 400 feet thick, contrasting with thicker Rustler Formation west of the western bounding displacement. Structure is very complicated in this domain due to uneven subsidence. The Rustler Formation in this subdomain probably has a low transmissivity in view of the depth and overburden thickness. The complicated structure likely indicates very discontinuous fractured zones,

although these may increase the transmissivity, as in other, shallower subsided domains over dissolution zones. This may be the case in Pecos County with the presence of Diamond Y Springs and several high capacity Rustler Formation wells (1,000 to 3,000 gallons per minute).

Subdomain 5

This subdomain is mainly important because it consists of outcrops of the Tessey Limestone, which is generally thought to be stratigraphically equivalent to Ochoan rocks including the Rustler Formation. While some reports indicate cavernous porosity in the Tessey Limestone, little is known about its properties. It is an outcrop to subcrop area generally, with thin Rustler Formation at greater depth north of the outcrop area. Although drillhole data points are not abundant, there is a major break in the elevation of the top of the Rustler Formation that has been interpreted as a fault trending west-northwest to east-southeast. Thus, the Tessey Limestone may be recharged along the Glass Mountains and as subcrops west of the Glass Mountains. Its connection to the Rustler Formation is uncertain, and the major displacement between Subdomains 5 and 4 and 5 and 7 may inhibit flow or may provide vertical connection that may maintain hydraulic connection between these subdomains.

Subdomain 6

This northern subdomain (east and northeast of the WIPP site) is characterized by Rustler Formation halite as well as considerable depth and thickness of intact Dewey Lake Formation and overlying formations. This area of the Rustler Formation is known to possess very low transmissivity and was excluded from the model.

Subdomain 7

This subdomain is characterized by an approximately eastward regional dip, no significant halite in the Rustler Formation, thick overlying Dewey Lake Formation, depths increasing to the east and generally less than 1,000 feet, and little indication of extensive Salado Formation dissolution. The Rustler Formation is more uniform in thickness in this subdomain than in most. The western boundary is marked by a significant drop in the top of the Rustler Formation elevation and less regular contours to the west. These are associated to the west with upper Salado Formation dissolution (in Subdomains 8 and 9). The eastern boundary of the subdomain

is the western graben fault. The main unit of hydrologic significance in this subdomain is likely to be the Culebra Dolomite Member, as the northern end of this subdomain is known from WIPP site studies. From WIPP studies, this portion of the Rustler Formation possesses a range of low transmissivity values.

Subdomain 8

Subdomain 8 has the characteristics of no Rustler Formation halite, relatively shallow depth (less than 750 feet deep) becoming more shallow to the west, thin or no overlying Dewey Lake Formation, and disrupted structure and surface features indicating Salado Formation dissolution and possible Rustler Formation dissolution of sulfates and carbonates. Rustler Formation thickness is generally 300 to 400 feet and somewhat variable. The western boundary is somewhat arbitrary and approximates the edge of Rustler Formation outcrops. The eastern boundary is more distinctive, showing marked elevation differences for the top of the Rustler Formation that are interpreted as a fault and also the margin between disturbed and undisturbed (Subdomain 7) areas. While the evidence of upper Salado Formation dissolution is unassessed in this project, the nature of the elevation changes are similar to those to the north where the upper Salado Formation has been removed. There may also be areas of relatively high transmissivity due to dissolution within the subdomain.

Subdomain 9

Similar to subdomain 8, the eastern boundary of this subdomain is along the margin where the top of the Rustler Formation is significantly displaced and structure contours exhibit more variable trends not all aligned along the regional dip. The western boundary is more arbitrary and approximates a depth of 400 to 500 feet to the top of the Rustler Formation. The subdomain structure is a general bowl or depression, with a very deep (greater than 1,000 feet) center and western side arbitrarily set. For much of this subdomain, the Dewey Lake Formation thickness is greater than 400 feet, with significant thinning along the west. There is no Rustler Formation halite known in this subdomain. As with Subdomain 8, a contributing factor to the disruption along the eastern boundary is believed to be dissolution of upper Salado Formation halite. This factor is unassessed by geophysical logs for this model domain. The western side of this

subdomain likely has low (or moderate) ranges of transmissivity, while the bulk of the subdomain is likely low to very low transmissivity, given the depth and nature of the overburden.

Subdomain 10 – Rustler Outcrop Shallow/Subcrop Area

Along the west and northwest part of the study area, the Rustler Formation crops out or is at very shallow depths. Within much of the Rustler Hills, the Rustler Formation is generally estimated to be 125 feet plus or minus 25 feet thick from limited outcrop descriptions and examination. The lower Rustler Formation (Los Medaños or Virginia Draw members) constitutes most of the outcrops, and some Culebra Dolomite Member commonly occurs at higher elevations. In subcrop and at very shallow depths, the Rustler Formation is likely unconfined or poorly confined. It has developed karst features, and hydraulic properties are likely to be highly variable.

Final Groundwater Availability Model for the Rustler Aquifer

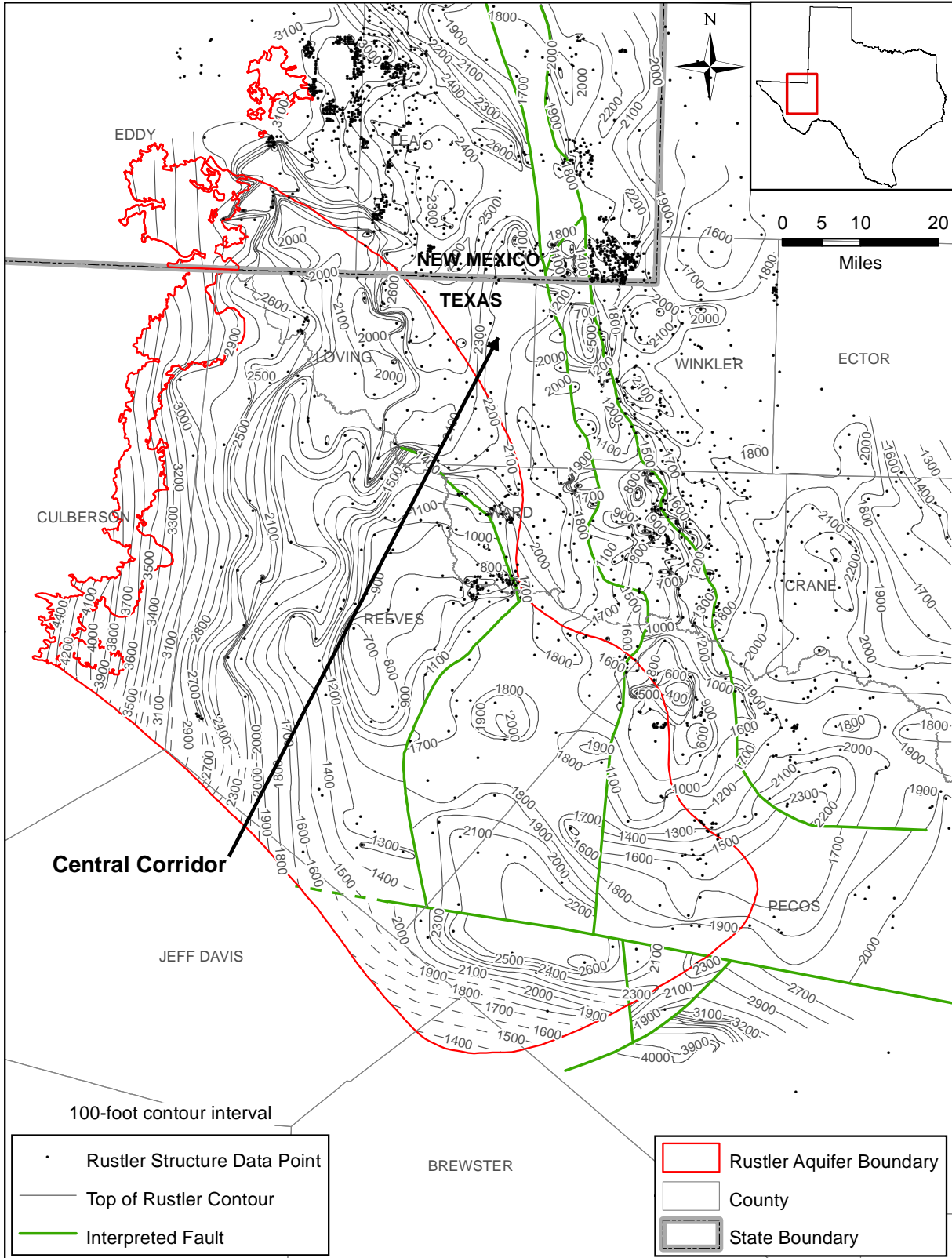

Figure 4.2.1 Hand drawn contours of the elevation (in feet above mean sea level) of the top of the Rustler Formation.

Final Groundwater Availability Model for the Rustler Aquifer

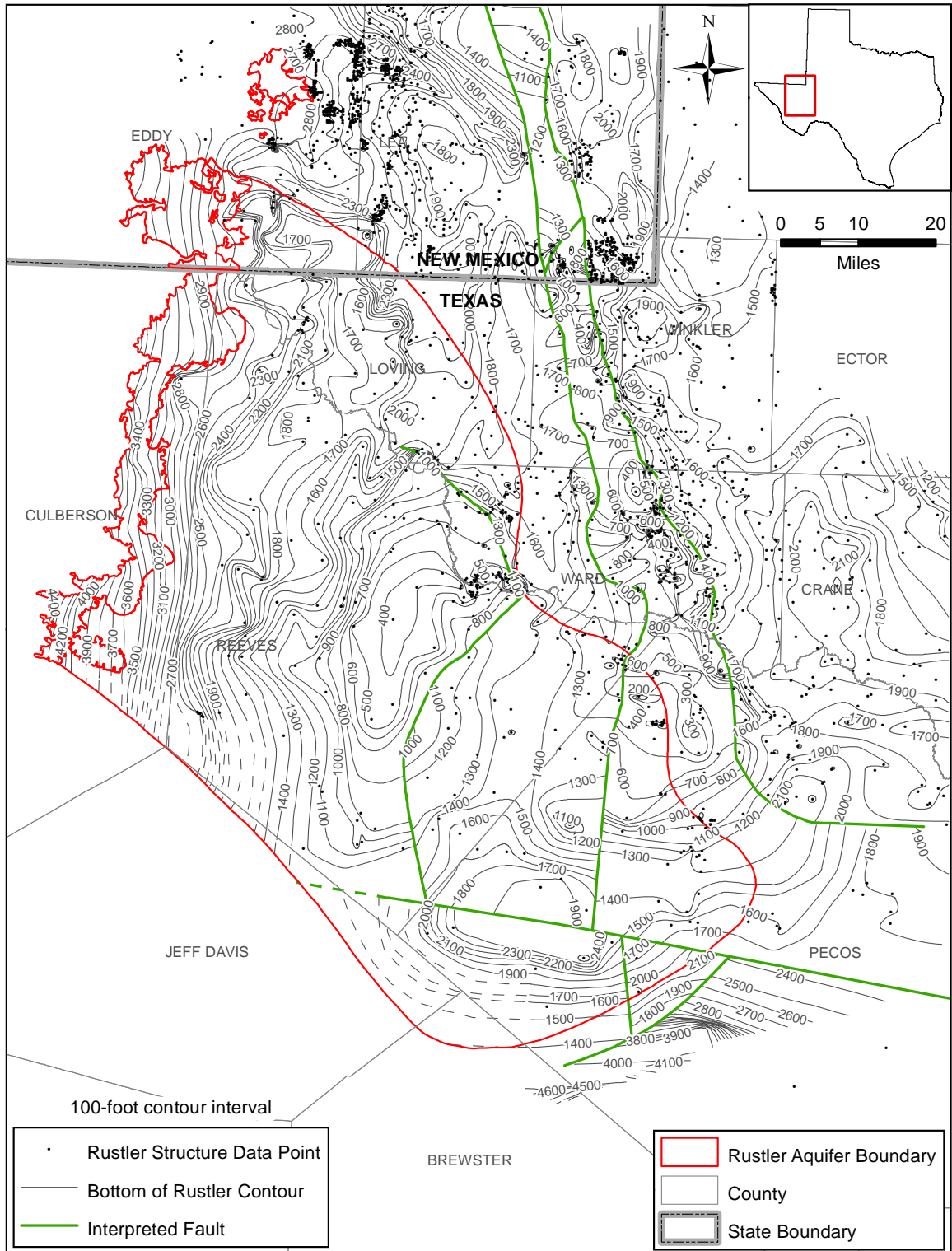

Figure 4.2.2 Hand drawn contours of the elevation (in feet above mean sea level) of the base of the Rustler Formation.

Final Groundwater Availability Model for the Rustler Aquifer

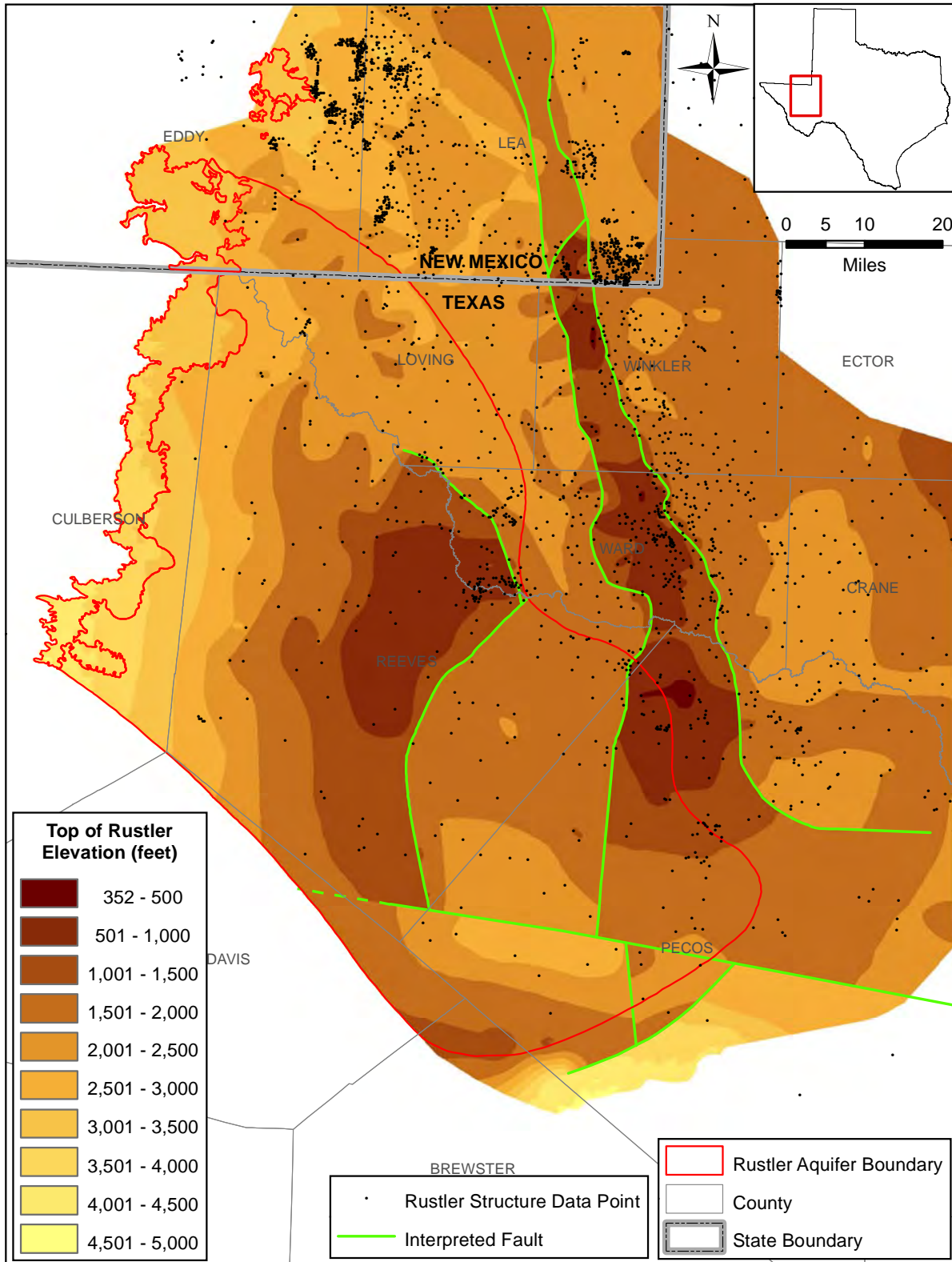

Figure 4.2.3 Interpolated elevation (in feet above mean sea level) of the top of the Rustler Formation.

Final Groundwater Availability Model for the Rustler Aquifer

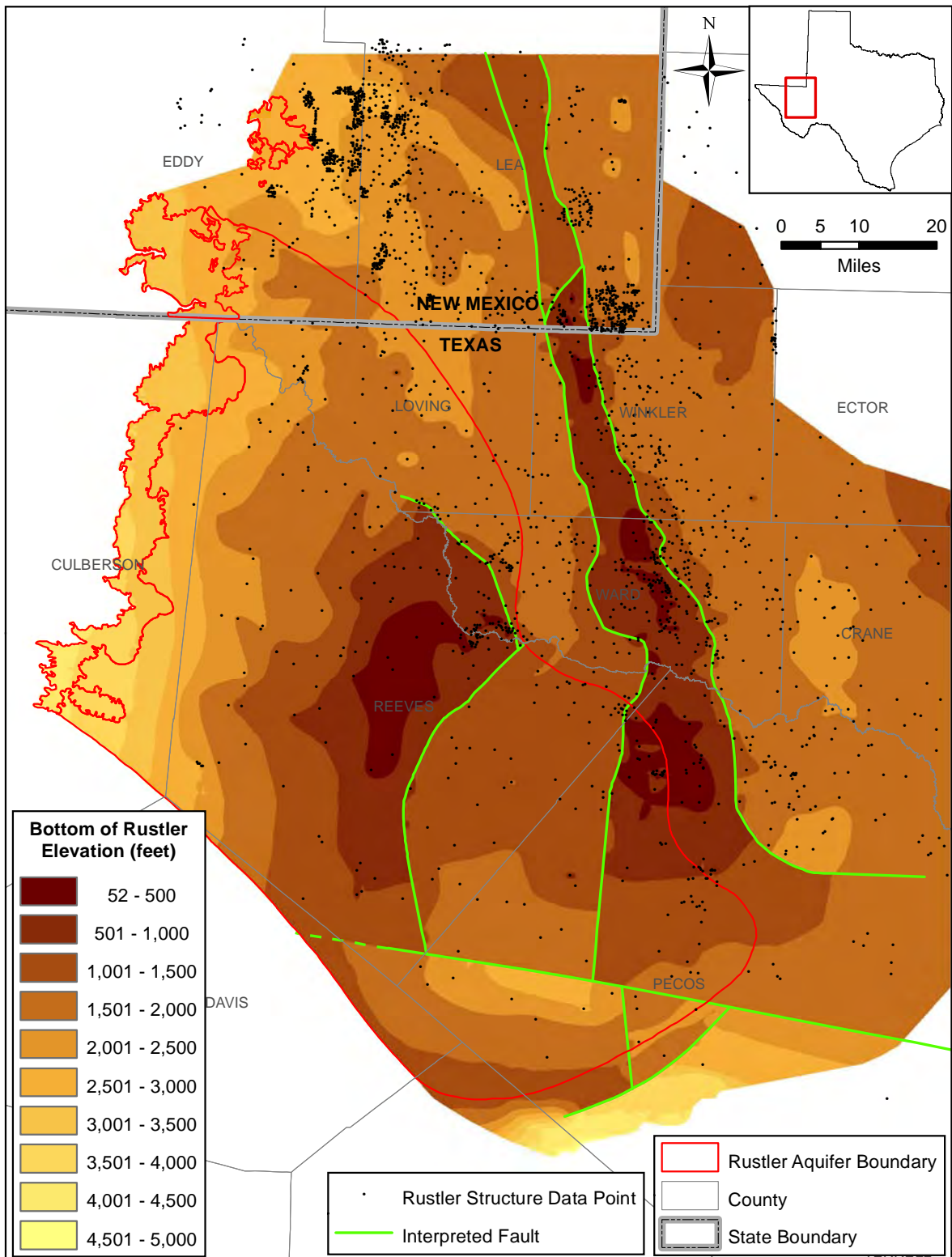

Figure 4.2.4 Interpolated elevation (in feet above mean sea level) of the bottom of the Rustler Formation.

Final Groundwater Availability Model for the Rustler Aquifer

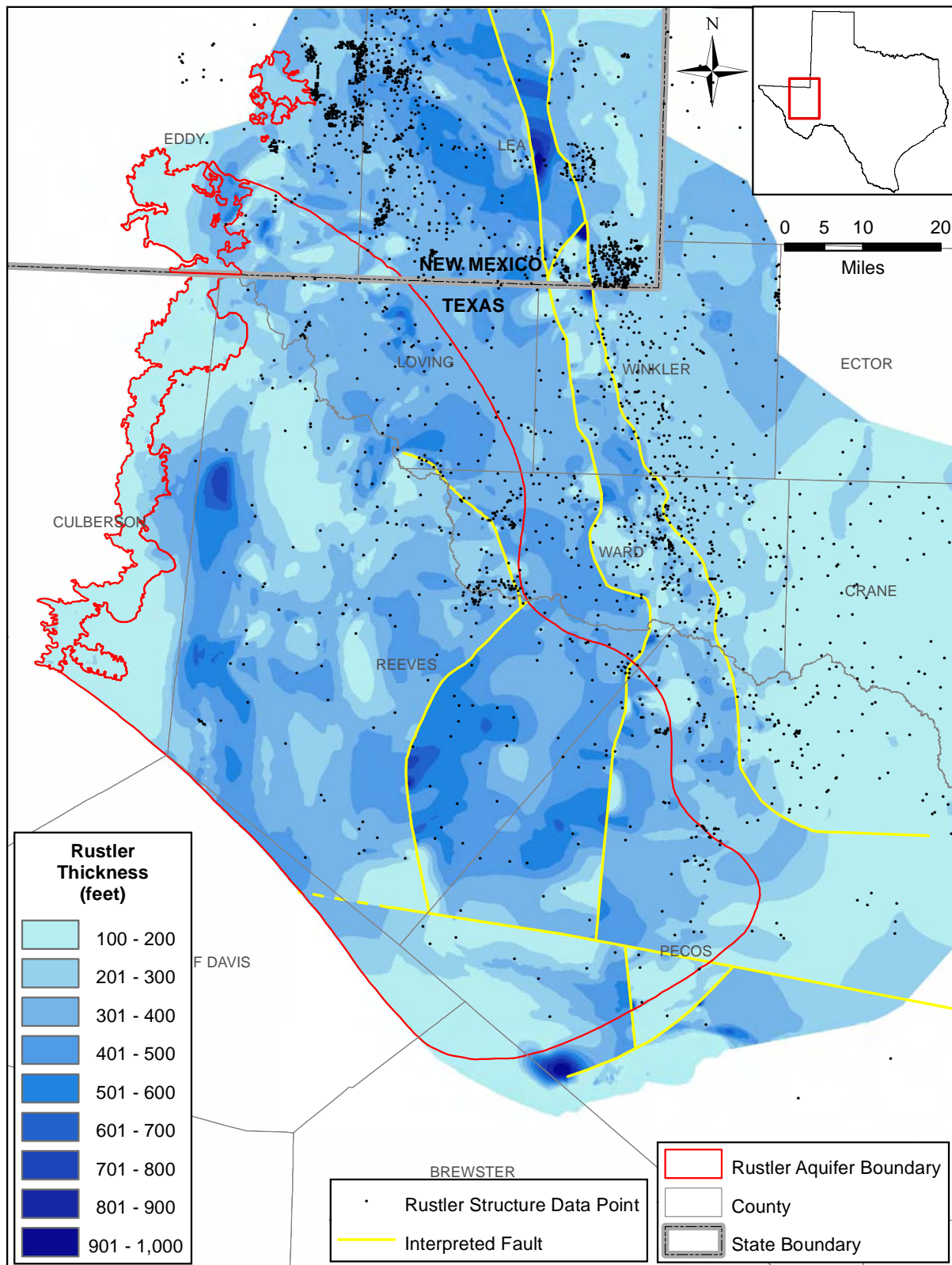

Figure 4.2.5 Isopach of Rustler Formation thickness (in feet).

Final Groundwater Availability Model for the Rustler Aquifer

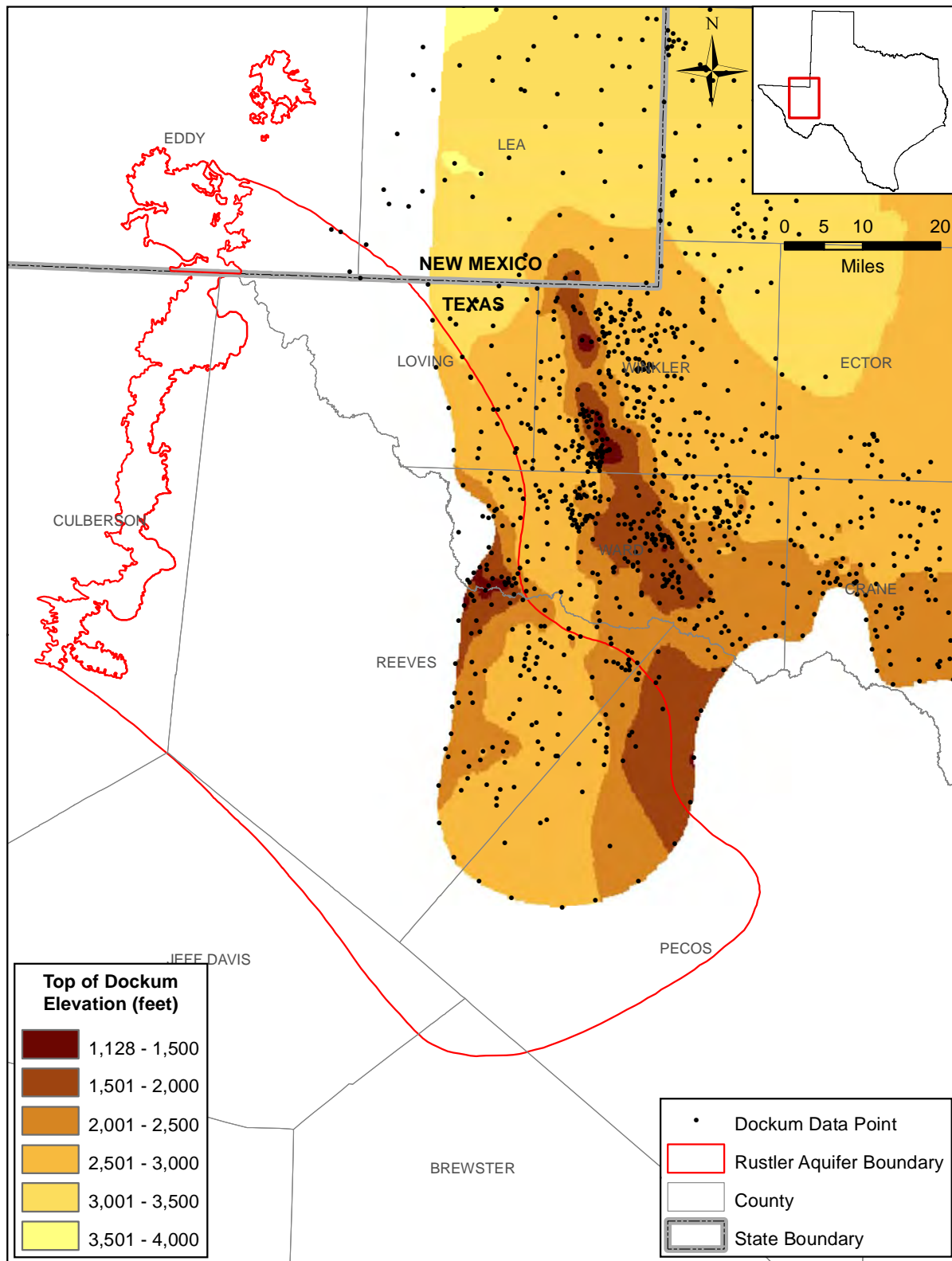

Figure 4.2.6 Elevation (in feet above mean sea level) of the top of the Dockum Aquifer.

Final Groundwater Availability Model for the Rustler Aquifer

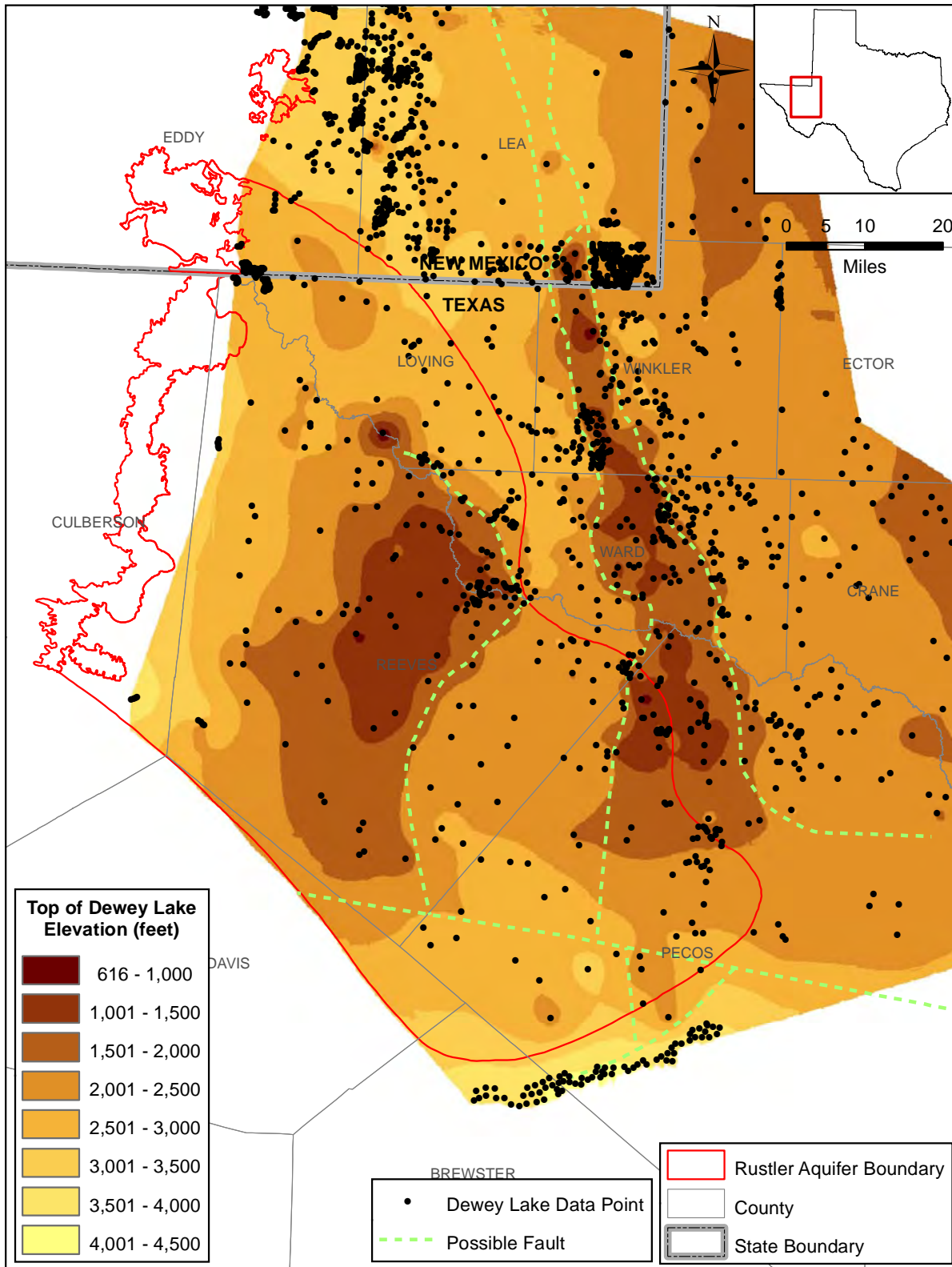

Figure 4.2.7 Elevation (in feet above mean sea level) of the top of the Dewey Lake Formation.

Final Groundwater Availability Model for the Rustler Aquifer

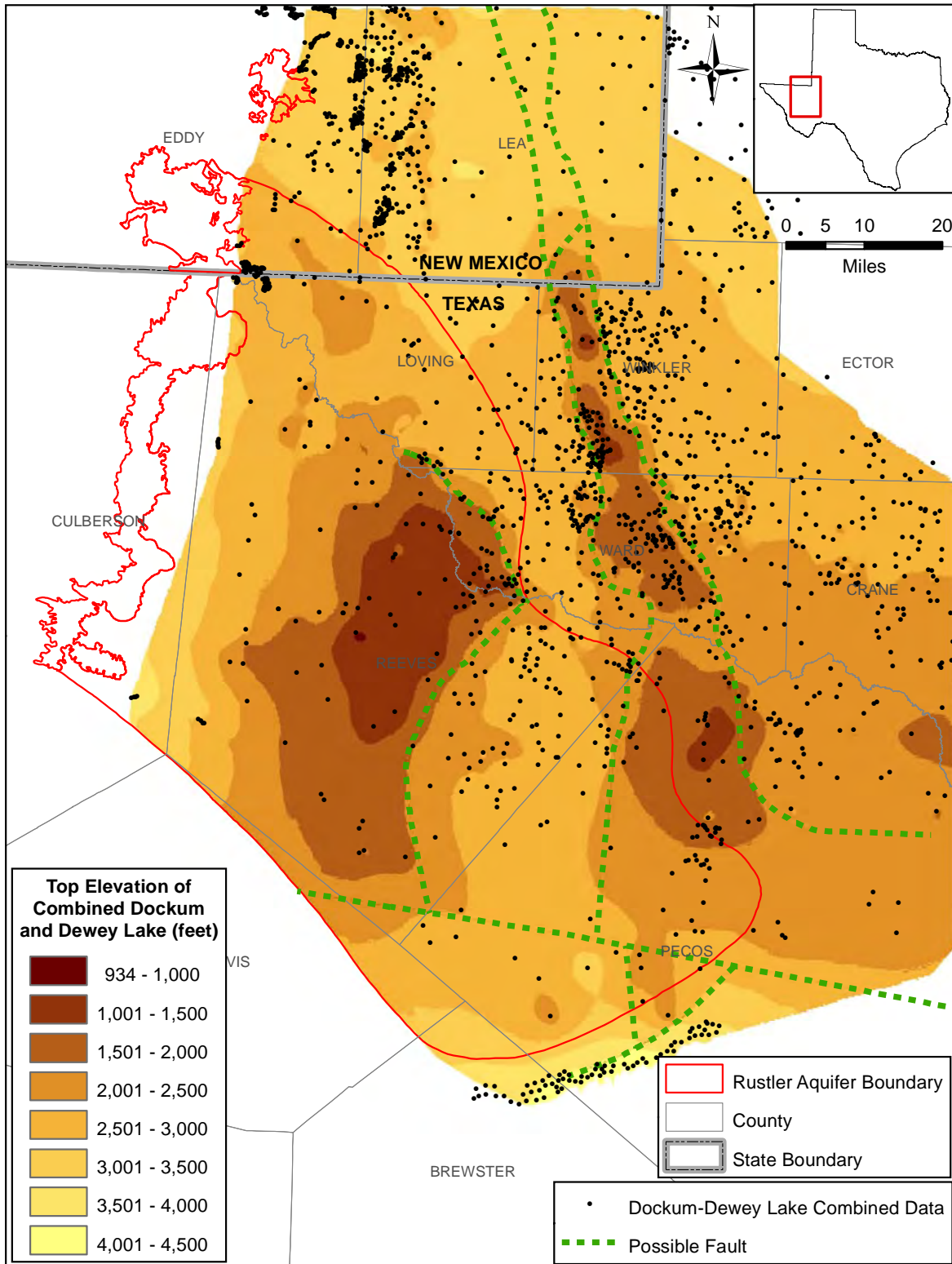

Figure 4.2.8 Elevation (in feet above mean sea level) of the top of the combined Dockum Aquifer and Dewey Lake Formation.

Final Groundwater Availability Model for the Rustler Aquifer

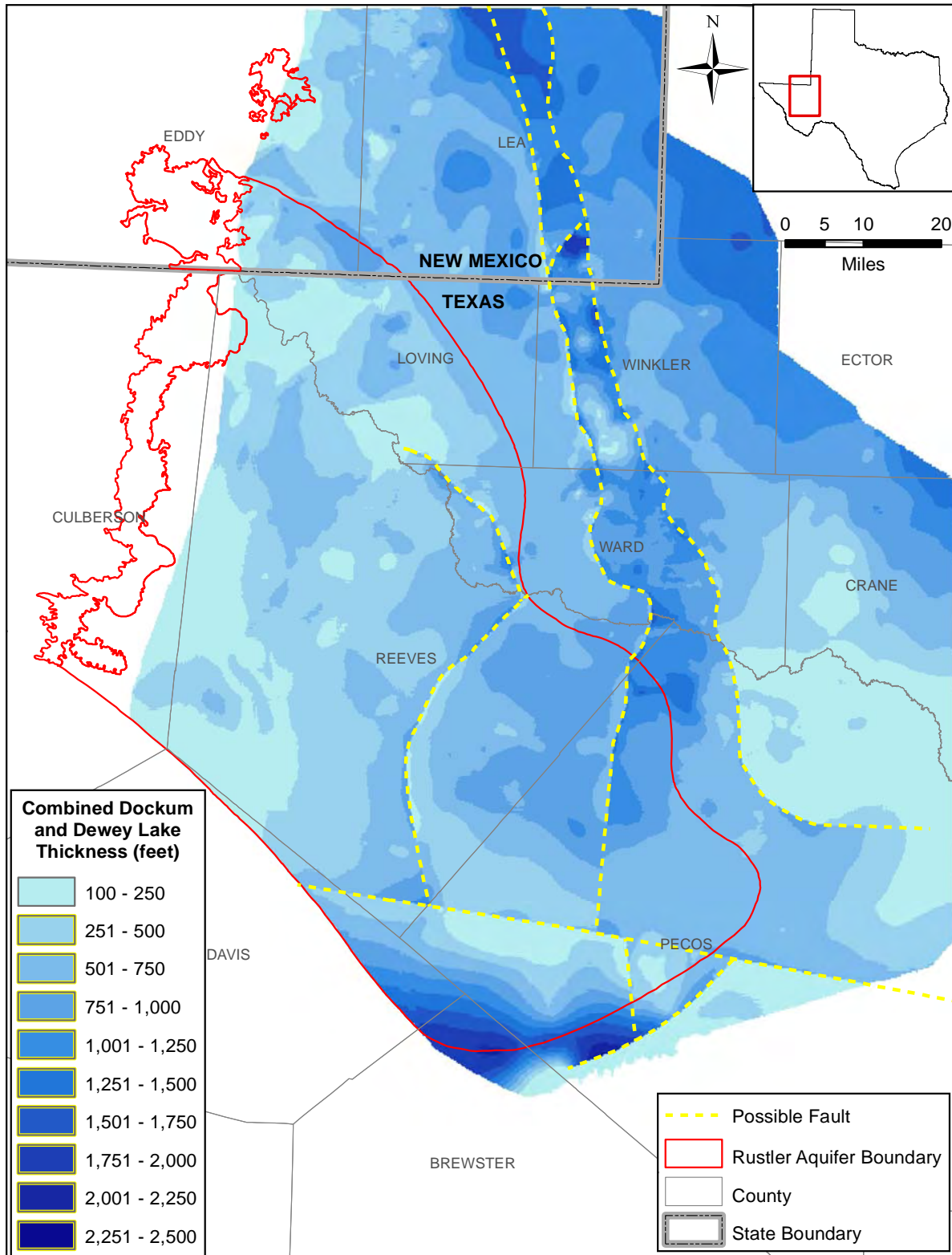

Figure 4.2.9 Isopach of the combined Dockum Aquifer and Dewey Lake Formation thickness (in feet).

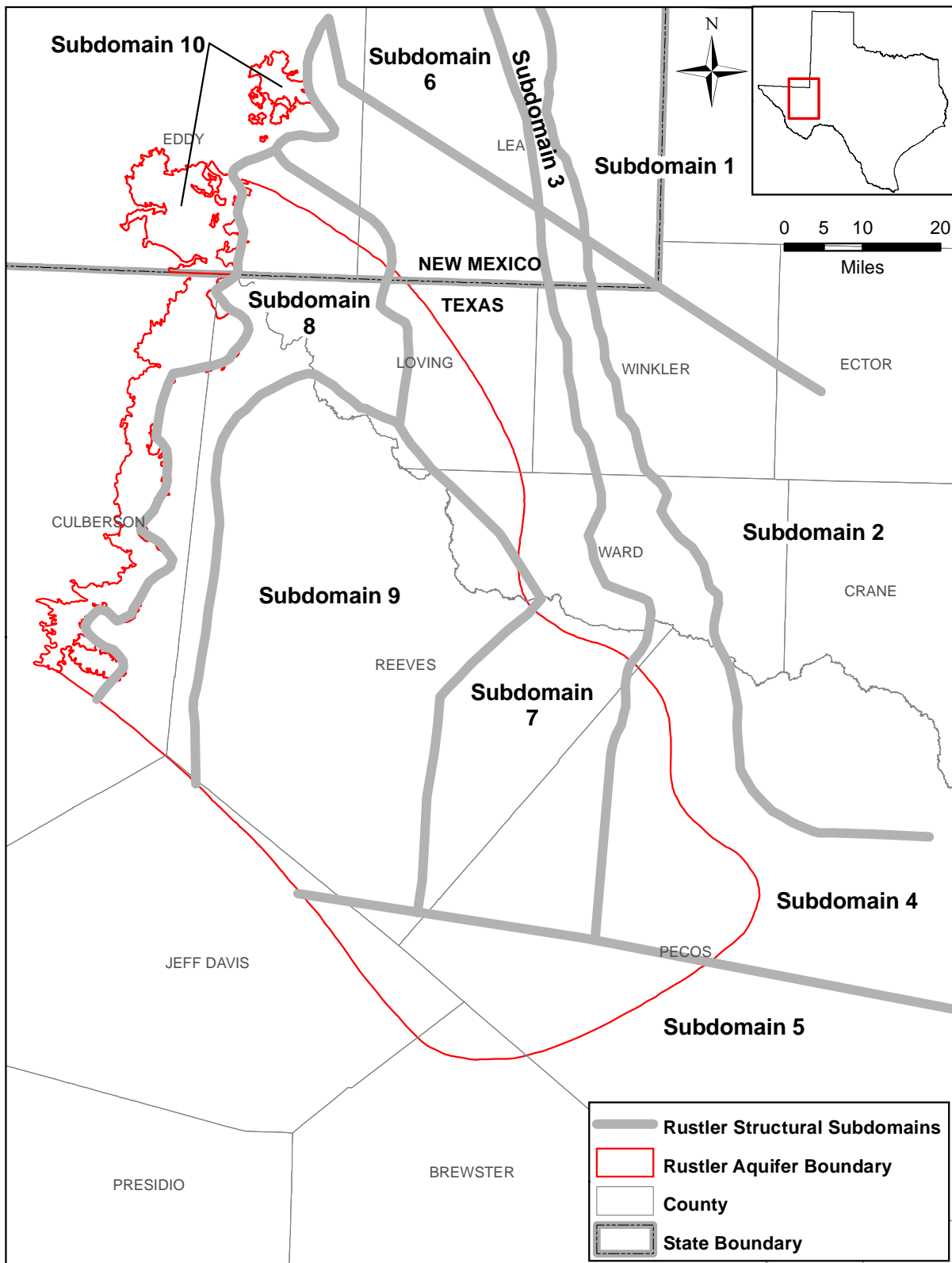

Figure 4.2.10 Structure domains in the Rustler Formation.

4.3 Water Levels and Regional Groundwater Flow

Water-level data for the Rustler Formation were obtained from the Texas Water Development Board (TWDB) groundwater database (TWDB, 2010c), records of wells and water-level measurements from county reports for Pecos, Reeves, and Winkler counties published by past Texas state agencies responsible for water resources (Armstrong and McMillion, 1961; Ogilbee and others, 1962; Garza and Wesselman, 1959), and the United States Geological Survey for data in New Mexico (Bowman, 2010). The cited county reports were used as sources because not all of the data in these reports are included in the TWDB groundwater database and an attempt was made to use all available data for the Rustler Aquifer. The locations of the wells with water-level data in the county reports were determined by georeferencing figures and then digitizing well locations. Consequently, there is a large degree of uncertainty in the location of these wells. Only water-level data for the Rustler Aquifer (aquifer code of 312RSLR) and identified as publishable in the TWDB (2010c) groundwater database were used. In addition, data indicated as having a questionable measurement or affected by pumping were disregarded. Only data identified as for the Rustler Formation in the county reports were used. After compiling wells identified as completed into the Rustler Formation, the completion data or total depth was compared to the formation structure. That comparison identified 10 wells that are probably not completed into the Rustler Formation for the reason given in Table 4.3.1. The water-level data for the Rustler Formation were used to evaluate (1) regional groundwater flow, (2) water levels under predevelopment conditions, (3) transient water-level conditions, and (4) cross-formational flow.

Table 4.3.2 summarizes the number of wells completed into the Rustler Formation in Texas by county and Figure 4.3.1 shows the location of those wells. A total of 95 wells are completed into the Rustler Formation; of which 63 fall within the boundary of the Rustler Aquifer. The majority of the wells are located in Pecos and Reeves counties. There is almost a complete lack of wells in the aquifer between the outcrop on the west and the fault in Reeves County. Also summarized in Table 4.3.2 is the number of water-level measurements by county. A total of 319 water-level measurements have been made with the majority of these measurements from Rustler Aquifer wells located in Pecos and Reeves counties.

The number of water-level measurements by year is illustrated in Figure 4.3.2. Several measurements are available prior to 1940. In general, these measurements correspond to flowing conditions in wells when they were drilled. The greatest number of measurements is available for 1959, followed by 1970 and 1967.

4.3.1 Regional Groundwater Flow

Groundwater in the Rustler Aquifer is under water-table conditions in the outcrop area. In general, groundwater in the downdip portion of the aquifer is under artesian conditions (Ashworth, 1990; Richey and others, 1985). In some confined areas, artesian pressures in the Rustler Aquifer were originally sufficient to drive water above ground surface. The locations of wells completed into the aquifer that originally flowed are shown in Figure 4.3.3. In general, these wells are located in Pecos County at the southern end of the graben and in Ward County along the Pecos River.

The temporal and spatial distribution of water-level data for wells completed into the Rustler Formation is insufficient to evaluate water-level conditions in the formation for one time period. In order to gain an understanding of general groundwater flow in the aquifer, the highest hydraulic head measured in each well was determined and posted on Figure 4.3.4. Also included on this figure are posted ground surface elevations for wells indicated as flowing but with no measured water level. Due to a high density of these data in some locations, closely spaced wells were grouped and the average water-level and/or ground surface elevation is posted for the group. The measurement dates for the data posted on this figure ranges from 1923 to 2008. Therefore, the data are not representative of actual groundwater conditions during a specific time period, but rather provide insight into overall flow patterns within the formation. Several features related to conclusions regarding groundwater flow in the Rustler Aquifer are also shown on Figure 4.3.4. The following discussion includes information gained from the data on Figure 4.3.4 as well as that obtained from the literature.

The Rustler Aquifer is recharged in its outcrop area in eastern Culberson County and southern Eddy County. In general, flow in the outcrop and shallow subcrop is from higher water-level elevations in the west to lower water-level elevations in the east (see Figure 4.3.4). From the outcrop area, flow in the aquifer is considered to be eastward and northeastward (White, 1971;

Boghici and Van Broekhoven, 2001). The lack of water-level data east, northeast, and southeast of the outcrop area prevents confirmation of this assumption of flow direction. Water-quality data in the Pecos Alluvium and Edwards-Trinity (Plateau) aquifers suggest that the Rustler Aquifer discharges into these two aquifers east of the Rustler outcrop (Rees and Buckner, 1980; Texas Water Commission, 1989; Ashworth, 1990; Jones, 2001, 2004). The magnitude of this discharge is unknown, as is the amount of water that migrates downdip into the aquifer subcrop. Richey and others (1985) suggest that groundwater in the Rustler Aquifer moves from the outcrop area to the Pecos River and its tributaries. It is likely that the majority of the water recharging the aquifer in the outcrop moves slightly downdip and discharges into the Pecos River or overlying aquifers with little flow continuing downdip.

The Rustler Aquifer grades into and appears to be recharged through the equivalent Tessey Limestone, which outcrops in the Glass Mountains located in southwestern Pecos County (Armstrong and McMillion, 1961; Ogilbee and others, 1962; Richey and others, 1985; Boghici, 1997; Boghici and Van Broekhoven, 2001). The water-level data in Figure 4.3.4 show, in general, higher levels in the south and lower levels moving northward to the Pecos River in Pecos County. This indicates that groundwater flow in the aquifer is to the north in Pecos County, which is consistent with the assumption of recharge through the Tessey Limestone, to a potentiometric low in the vicinity of the Pecos River. In eastern Reeves County, the data in Figure 4.3.4 generally show higher water-level elevations to the southwest and lower elevations moving to the northeast toward the Pecos River indicating southwest to northeast groundwater flow in this region. The most likely source of water from the southwest is the Rounsaville Fault and/or the Davis Mountains (see Figure 2.1.3). Based on hydrologic and geochemical data, Boghici (1997) concluded that the source of water discharging at Diamond Y Springs is the Rustler Formation. Diamond Y Springs cannot, however, account for all discharge from the Rustler Aquifer in this area because the elevation of the springs is over 400 feet higher than the water-level elevations in the Rustler Formation farther north in the potentiometric low along the Pecos River.

The limited available water-level data as depicted in Figure 4.3.4 indicates that flow in the Rustler Formation is generally to the southeast in Loving and Winkler counties and to the south in Ward and Crane counties. Like the northward flow in Pecos County, this southward flow is

toward a potentiometric low in the vicinity of the Pecos River. Discharge of groundwater in the vicinity of this low may be to the overlying Edwards-Trinity (Plateau) Aquifer through faulting associated with the collapse of the Rustler Formation in the graben and to the Pecos River. The high total dissolved solids concentrations in the Edwards-Trinity (Plateau) Aquifer (Bush and others, 1994) suggest discharge from deeper, more saline formations in this area.

In summary, available data regarding groundwater in the Rustler Aquifer suggests the existence of two independent flow systems. One system consists of recharge in the outcrop and discharge to the Pecos River and/or overlying aquifers in the shallow subcrop with little to no deep downdip flow. The second system consists of recharge in the Tessey Limestone and northward flow toward the Pecos River in Pecos County, and recharge from the Rounsaville Fault and/or the Davis Mountains and northeastern flow to the Pecos River in eastern Reeves Counties. The hydrologic data do not indicate a connection between the Rustler Formation outcrop in Culberson County and the wells completed into the Rustler Aquifer located in eastern Reeves County and western Pecos County.

4.3.2 Pre-Development Conditions

Pre-development conditions are defined as those existing prior to significant disturbances of natural groundwater flow due to artificial discharge via pumping. Typically, predevelopment conditions represent steady-state conditions in the aquifer; where aquifer recharge is balanced by natural aquifer discharge. Table 4.3.3 summarizes the number of wells completed into the Rustler Aquifer by decade from 1920 through 2009 based on available data from the TWDB (2010c) and the Pecos, Reeves, and Winkler county reports (Armstrong and McMillion, 1961; Ogilbee and others, 1962; Garza and Wesselman, 1959, respectively). This table shows that two wells were completed into the Rustler Formation in the 1920s and the largest number of well completions occurring in the 1950s. Both of the wells completed in the 1920s and two of the three wells completed in the 1930s flowed when drilled. Well 4640801 located in Ward County was reported to have nearly flooded out the area when it was drilled in 1920. Well 4638601, also in Ward County, was reported to flow 1,800 gallons per minute when it was drilled in 1923.

Since the majority of wells completed into the Rustler Formation were drilled in the 1950s, water-level data prior to 1950 were assumed to be representative of pre-development conditions.

These data are not sufficient to generate contour maps. Pre-development water-level elevations for the Rustler Aquifer and other portions of the Rustler Formation are posted in Figure 4.3.5. Data prior to 1950 consists of three water-level measurements and nine indications of flowing conditions at wells. For the flowing wells, the ground surface elevation is posted rather than the water-level elevation because the height of the water column above surface is not reported. Therefore, the actual pre-development water-level elevation is higher than the posted ground surface elevation. Two of the wells with a water-level measurement were also flowing, but the height of the water level above ground surface was given.

The water-level and ground surface elevations posted on Figure 4.3.5 show that pre-development water-level data are available only in Pecos and Ward counties. These data show a generally decreasing trend from south to north in Pecos County and from north to south in Ward County, with the lowest water level along the Pecos River about where the Crane, Pecos, and Ward county lines converge. The predevelopment water-level data are summarized in Table 4.3.4.

4.3.3 Water-Level Elevations for Transient Model Calibration

Traditionally, transient model calibration for GAM models has considered the time period from January 1, 1980 to December 31, 1997. As such, water-level data obtained from the TWDB (2010c) groundwater database were used to look at water-level elevations in the Rustler Aquifer and the Rustler Formation for January 1980, January 1990, December 1997.

Water-level data are not available at regular time intervals in every well. Therefore, the coverage of water-level data for a particular month, or even a year, is very sparse. Since the amount of water-level data available for the three times of interest are not sufficient to evaluate water-level elevations, data for the year of interest and for five years prior to and five years after the year of interest were used. If a well had only one water-level measurement during that time, that measurement was used. If a well had several water-level measurements during that time, the average of the water levels was used.

Data are not sufficient to create contour maps. Therefore, the water-level elevations for January 1980, January 1990, and December 1997 are shown as posted values on Figures 4.3.6 through 4.3.8, respectively.

A comparison of water levels for January 1980, January 1990, and December 1997 is difficult based solely on the posted values in Figures 4.3.6 through 4.3.8. Table 4.3.5 presents the available average water-level elevations for 1980, 1990, and 1997. Many of the wells in this table have an average value for 1990 but not for 1980 or 1997. For the four wells in Ward County, no water-level measurements are available, only an indication that they were flowing. Table 4.3.5 also shows the change in water-level elevation from 1980 to 1990, 1990 to 1997, and 1980 to 1997 for wells with data at these times. The information in this table is plotted on Figures 4.3.9 through 4.3.11 for the 1980 to 1990, 1990 to 1997, and 1980 to 1997 time periods, respectively. The site numbers used to identify wells on these figures are also included in Table 4.3.5.

Figure 4.3.9 indicates a water level decline of greater than 130 feet in a well in Culberson County, a water level increase of 11 to 25 feet in a well in Reeves County and a well in Crane County, and a water level increase of greater than 40 feet in two wells in Pecos County between 1980 and 1990. Figure 4.3.10 indicates a water level decline of less than 5 feet in a well in Reeves County and another well in Crane County, no change in water level in two wells in Culberson County, a water level increase of less than 5 feet in two wells in Culberson County, and water level increases between 15 and 25 feet in two wells in Pecos County between 1990 and 1997. Figure 4.3.11 indicates a water level decline of greater than 130 feet and a water level increase of 5 to 10 feet in wells located close together in Culberson County, a water level increase between 5 and 10 feet in a well in Reeves County, a water level increase of 15 to 25 feet in a well in Crane County, and a water level increase greater than 60 feet in two wells in Pecos County. The reason for the large discrepancy in water level change in the two wells in Culberson County that are located near each other is unknown. Only two water-level measurements are available, therefore, no long-term, water-level trend can be determined for these two wells.

Analysis of water-level data for the traditional transient model calibration period shows a paucity of data for the Rustler Aquifer and Rustler Formation and, in general, little variation in water levels during this time period. Several Rustler Aquifer wells with multiple water-level measurements show a sharp decline in water levels in the mid- to late 1960s followed by a recovery period beginning around 1980. Because some large changes in the aquifer are observed

prior to 1980, the transient calibration period for the Rustler Aquifer GAM was extended back to 1939. The transient calibration period was also extended forward until 2008. The actual transient model begins in 1919, which is the first year with data on pumpage from the Rustler Aquifer (see Section 4.7.2), but calibration of the transient model begins in 1939. All of the water-level data for the Rustler Aquifer and Rustler Formation within the active model boundary were used as calibration targets for the transient calibration period. This enabled the use of all available water-level data related to changes in the aquifer to constrain the transient model. A discussion of the transient water-level data is provided in Section 4.3.5.

4.3.4 Cross-Formational Flow

Cross-formational flow into the Rustler Aquifer from underlying formations and from the Rustler Aquifer into overlying formations was investigated by two methods. First, water-level data in the Rustler Aquifer were compared to water-level data in overlying and underlying aquifers to evaluate the potential for upward flow. Second, a literature review was conducted to obtain published information regarding cross-formational flow into and out of the Rustler Aquifer.

Water-level elevations in the Rustler Aquifer were compared to water-level elevations in overlying aquifers at several locations. Except in western Reeves County, the Rustler Aquifer is overlain by the siltstone-rich Dewey Lake Formation. Figure 4.3.12 shows the boundaries, as defined in George and others (2011), for the three aquifers that overlie the Rustler Aquifer. From youngest to oldest, these are the Pecos Valley, Edwards-Trinity (Plateau), and Dockum aquifers. The Dockum Aquifer directly overlies the Dewey Lake Formation in all places where the Dockum Aquifer is present. The Edwards-Trinity (Plateau) Aquifer directly overlies the Dewey Lake Formation in all areas where the Edwards-Trinity (Plateau) Aquifer is present except where the Dockum Aquifer is also present. The Pecos Valley Aquifer directly overlies the Dewey Lake Formation where it is the only overlying aquifer present.

The comparison between water-level elevations in the Rustler Aquifer and water-level elevations in the overlying aquifers considered only the oldest and deepest overlying aquifer. For example, in instances where both the Dockum and Edwards-Trinity (Plateau) aquifers overlie the Rustler Aquifer, water levels in the Rustler Aquifer were compared only to water levels in the Dockum Aquifer. The comparisons were made in wells that are completed into the different aquifers but

have a similar surface location and similar water-level measurement dates. The eight locations for the wells used in the comparisons are also shown on Figure 4.3.12. This comparison does not quantify cross-formational flow between the aquifers, but rather assesses the potential for cross-formational flow. Whether cross-formational flow occurs or not is a function of how well the two aquifers are hydraulically connected across the Dewey Lake Formation.

A comparison at two locations indicates that water-level elevations in the Rustler Aquifer are lower than those in the Dockum Aquifer (Figure 4.3.13) indicating the potential for downward flow from the Dockum Aquifer to the Rustler Aquifer. Note that the scale of the y-axis is different for the two plots shown in this figure. Water-level elevations in the Rustler Aquifer are higher than those in the Edwards-Trinity (Plateau) Aquifer at five locations in Pecos County (Figure 4.3.14), indicating the potential for upward flow from the Rustler Aquifer into the Edwards-Trinity (Plateau) Aquifer. These comparisons are all in about the same location so little information about the potential for flow between these two aquifers is available across the majority of the Rustler Aquifer. The water level in the Rustler and Pecos Valley aquifers is about the same at one location in Reeves County (Figure 4.3.15), indicating little potential for flow from one aquifer to the other at that location.

In summary, there appears to be a potential for downward flow from the Dockum Aquifer to the Rustler Aquifer throughout the area where the two aquifers are present. A potential for upward flow from the Rustler Aquifer to the Edwards-Trinity (Plateau) Aquifer exists in a small area of Pecos County but is unknown over the remainder of the area where the two aquifers are present. At one location, there was little potential for flow between the Rustler and Pecos Valley aquifers indicated. However, the data are insufficient to draw any regional conclusions.

The water-level elevation in the Rustler Aquifer was also compared to the water-level elevation in the underlying Capitan Reef Complex Aquifer (Figure 4.3.16). That comparison shows lower water-level elevations in the deeper Capitan Reef Complex Aquifer than in the Rustler Aquifer indicating a potential for downward flow from the Rustler Aquifer to the Capitan Reef Complex Aquifer at that location. Because this comparison was made at only one location, it provides little information about the potential for flow between these two aquifers in other areas where both aquifers are present. Although this comparison indicates the potential for downward flow,

both Veni (1991) and Armstrong and McMillion (1961) theorize that groundwater discharges from the Capitan Reef Complex Aquifer into the Rustler Aquifer north of Fort Stockton and in northern Pecos County, respectively. It is likely that predevelopment gradients from the Capitan Aquifer to the Rustler Aquifer in south-central Pecos County were upward owing to the fact that the Capitan Aquifer recharge zone is at a higher elevation than the Rustler Aquifer (Tessey Limestone) in the Glass Mountains and the assumption that the transmissivity of the Capitan Aquifer is greater than that of the Rustler Aquifer.

A literature review was conducted to obtain published information on cross-formational flow into and out of the Rustler Aquifer. The majority of the available literature relates to the sources of poor water quality in the overlying Edwards-Trinity (Plateau) Aquifer, which has been studied much more extensively than the Rustler Aquifer. Bush and others (1994) conducted an investigation into the dissolved solids concentrations and hydrochemical facies of water in the Edwards-Trinity (Plateau) Aquifer in west-central Texas. They found the highest total dissolved solids concentrations in the portion of the aquifer located in the Trans-Pecos area; specifically in Reeves County and northwestern Pecos County. They defined the hydrochemical facies of the groundwater found in this area as saline mixed and calcium sulfate. Bush and others (1994) hypothesized that the source of sulfate and chloride in the Edwards-Trinity (Plateau) Aquifer in this area is adjacent, hydraulically connected aquifers such as the overlying Pecos Valley Aquifer and the underlying Dockum, Rustler, and Capitan aquifers. This suggests that water may discharge from the Rustler Aquifer via cross-formational flow into the overlying Edwards-Trinity (Plateau) Aquifer.

The presence of sulfate facies groundwater in the Edwards-Trinity (Plateau) Aquifer in Reeves County and northwestern Pecos County indicates that the source of the water is Rustler Hills (Sharp, 1989; Uliana, 2001; Uliana and Sharp, 2001). The Rustler Aquifer and other Ochoan series formations outcrop in Rustler Hills. Whether the sulfate-rich water from Rustler Hills enters the Edwards-Trinity (Plateau) Aquifer via cross-formational flow or by surface infiltration along draws is unknown.

Based on the results of numerical modeling, Boghici (1997) reports groundwater from the Rustler Aquifer discharges to the overlying Edwards-Trinity (Plateau) Aquifer in Pecos County

through the Diamond Y fault system and by upwelling in the vicinity of Belding and he estimated values of 260 and 3,800 acre-feet per year, respectively. Barker and Ardis (1992) state that relatively large concentrations of dissolved solids, sulfate, and chloride in the Edwards-Trinity (Plateau) Aquifer in northeastern Pecos County may indicate cross-formational flow from the Rustler Aquifer and/or the Salado Formation. This is an area where the Dockum Aquifer is missing and the Edwards-Trinity (Plateau) Aquifer directly overlies the Rustler Aquifer or the Salado Formation where the Rustler Formation is missing (Barker and Ardis, 1992). Rees and Buckner (1980) report that the high total dissolved solids concentrations in the Edwards-Trinity (Plateau) Aquifer in Culberson and northwest Reeves counties are primarily due to cross-formational flow from the Rustler and Castile formations and those in north-central Pecos County are primarily due to cross-formational flow from the Rustler Formation. Cross-formational flow from the Rustler Aquifer into the Edwards-Trinity (Plateau) Aquifer may occur in north-central Pecos County based on high sulfate concentrations in the Edwards-Trinity (Plateau) Aquifer (Small and Ozuna, 1993). Groundwater from several wells completed into the Edwards-Trinity (Plateau) Aquifer near the city of Toyah contain chloride and sulfate concentrations similar to those found in groundwater in the Rustler Aquifer suggesting cross-formational flow from the Rustler Aquifer to the Edwards-Trinity (Plateau) Aquifer in this area (Knowles and Lang, 1947). Brown and others (1965) state that the Rustler Aquifer probably discharges to overlying strata via cross-formational flow; however, they do not indicate which strata the aquifer discharges to or where the cross-formational flow occurs.

Cross-formational flow from the Rustler Aquifer into the Pecos Valley Aquifer occurs in the western portion of the Pecos Valley Aquifer according to Ashworth (1990). The sulfate-rich groundwater in the Pecos Valley Aquifer in western Reeves County is attributed to the flow of groundwater from the Rustler Aquifer. Based on analysis of water quality, Armstrong and McMillion (1961) suggest that the Pecos Valley Aquifer is recharged by the Rustler Aquifer via cross-formational flow in the north-central part of Pecos County. The higher total dissolved solids concentrations in the Pecos Valley Aquifer in northern Reeves County where the Dewey Lake Formation is absent may indicate cross-formational flow from the Rustler Aquifer (Richey and others, 1985).

Numerous reports suggest that cross-formational flow occurs from the Tessey Limestone to the Rustler Aquifer (Armstrong and McMillion 1961; Ogilbee and others, 1962; Richey and others, 1985; Small and Ozuna, 1993; Boghici, 1997; Boghici and Van Broekhoven, 2001). The Tessey Limestone outcrops in the Glass Mountains and is equivalent in age to the Salado and Rustler formations.

Boghici (1997) suggests the occurrence of cross-formational flow from deeper Ochoan formations into the Rustler Aquifer based on analysis of groundwater chemistry. He states that the dolomitic-gypsiferous nature of the Rustler Formation is reflected by the predominantly Ca-Mg-SO₄ facies of the groundwater in the aquifer. However, Na-Cl-SO₄ type water is observed in the aquifer in areas along the Belding-San Simon trough described by Hiss (1976). Boghici (1997) suggests that the source of the Na-Cl water in these areas, where the Rustler Aquifer is thin and extensive deep faults are present due to dissolution, is upwelling of water from underlying Ochoan formations. Based on water chemistry, Armstrong and McMillion (1961) theorize that highly mineralized water observed in the Rustler Aquifer in northern Pecos County may be due to inflow from the underlying Capitan or San Andres limestones along a deep fault system. The mineral content of the water originating in the Capitan or San Andres limestones would greatly increase as it traveled through the Castile and Salado formations along a postulated fault system (Armstrong and McMillion, 1961). High chloride concentrations in the Rustler Aquifer in north-central Pecos County could be the result of water from the Capitan Aquifer migrating upward through a hydraulic connection and mixing with water in the Rustler Aquifer (Small and Ozuna, 1993). Ogilbee and others (1962) state that the Rustler Aquifer is recharged by cross-formational flow from adjacent aquifers; however, they do not indicate which aquifers provide this inflow or where the inflow from other aquifers occurs. Brown (1998) hypothesizes that the radioactivity observed in groundwater in the Rustler Aquifer may be the result of water migrating upward from deeper formations. He states that although radioactivity naturally occurs in groundwater in uranium-rich and deep aquifers, the Rustler Aquifer neither contains uranium nor is particularly deep. He also states that further research is needed to confirm the source of radioactivity in the Rustler Aquifer.

In summary, a review of the literature indicates the following with respect to cross-formational flow into and out of the Rustler Aquifer.

- Groundwater may flow from the Rustler Aquifer into the overlying Edwards-Trinity (Plateau) Aquifer in Reeves and northwest Pecos counties through the Diamond Y fault system identified by Boghici (1997), in the vicinity of Belding, in northeastern Pecos County, in Culberson County, in north-central Pecos County, and in northwest Reeves County.
- Groundwater may flow from the Rustler Aquifer into the overlying Pecos Valley Aquifer in the western portion of the Pecos Valley Aquifer, in northern and western Reeves County, and in north-central Pecos County.
- Groundwater recharging the Tessey Limestone in the Glass Mountains, which is a facies equivalent to the Rustler Aquifer, flows into the Rustler Aquifer.
- Veni (1991) and Armstrong and McMillion (1961) theorize upward flow from the Capitan Reef Complex Aquifer to the Rustler Aquifer.

4.3.5 Transient Water Levels

Figure 4.3.17 shows the locations of the seven wells completed into the Rustler Aquifer, or into the Rustler Formation outside the limits of the aquifer, for which five or more transient water-level measurements are available. These transient data were obtained from the TWDB (2010c). Five or more measurements are also available for one well in Ward County. This well is not shown on Figure 4.3.17, however, because it was observed to be flowing at the time of each measurement and the height of the water-level above ground surface was not recorded so a hydrograph of measurements could not be created. Table 4.3.6 summarizes all of the available water-level data; including the year of the first and last water-level measurement and the total number of water-level measurements. All wells are included on this table so that the measurement date(s) for wells with fewer than five measurements can be seen.

The hydrographs of transient water-level data for the two wells in Culberson County and one well in Crane County are shown in Figure 4.3.18. For well 4754201 in Culberson County, the water level remained fairly stable from the first water-level measurement in 1960 to the most recent measurement in 2009. For well 4754302 in Culberson County, the water level declined about 30 feet between the first measurement in 1970 and the second measurement in 1995.

Since 1995, water levels in this well have fluctuated less than 20 feet. The difference in water-level elevation between these two wells, which are located about 1.3 miles apart, was about 160 feet in 1997 even though the difference in their surface elevation is only about 40 feet. This indicates that water levels in the Rustler Aquifer can have large variability over small distances. One explanation may be that these wells are completed to different portions (i.e., upper portion versus lower portion) of the aquifer. An increase of about 70 feet between the first measurement in 1974 and a measurement in 1987 is observed in well 4544601 in Crane County. The water level in that well decreased about 11 feet between 1987 and 1989 and then remained stable until the final measurement in 1993.

The hydrographs of the transient water-level data for the two wells in Pecos and Reeves counties are shown on Figure 4.3.19. Water levels in the two wells in Pecos County, which are located about one mile apart, are very similar in both trend and magnitude. They both show an initial overall decrease in water level from the mid-1960s to about 1970, fairly stable water levels for a period of time, and then an overall increasing trend through the end of the record. The main difference between the water levels observed in these two wells is the time at which the water level began to significantly rise, which was about 1979 for well 5216608 but not until about 1989 for well 5216609.

A sharp increase in water level between 1959 and 1965 is observed in well 4660902 in Reeves County (see Figure 4.3.19). A review of the drillers' logs for this well (TWDB, 2010d) indicates that it was reworked in 1964. It appears that reworking the well resulted in a significant change in water level as indicated by the about 174-foot difference between the water level first encountered in the well and the water levels measured in the well after it was reworked. For well 5204302 in Reeves County, the water level declined about 50 feet from the first measurement in 1958 to the last measurement in 1970.

Final Groundwater Availability Model for the Rustler Aquifer

Table 4.3.1 Wells not considered to be completed into the Rustler Formation.

State Well Number or County Report Number	County	Comment
4535901	Crane	The bottom of the well lies about 15 feet above the top of the Rustler Formation.
4601202	Loving	The bottom of the well lies about 191 feet above the top of the Rustler Formation.
AA-10	Pecos	The bottom of the well lies only 60 feet below the top of the 316-foot thick Rustler Formation.
P-120	Pecos	The bottom of the well lies only 32 feet below the top of the 346-foot thick Rustler Formation.
Q-2	Pecos	The bottom of the well lies only 10 feet below the top of the 298-foot thick Rustler Formation.
Q-137	Pecos	The bottom of the well lies about 8 feet above the top of the Rustler Formation.
4542703	Pecos	The bottom of the well lies only 9 feet below the 241-foot thick Rustler Formation.
5215502	Pecos	The bottom of the well lies only 36 feet below the top of the 390-foot thick Rustler Formation.
4660903	Reeves	The bottom of the well lies about 93 feet above the top of the Rustler Formation.
4640701	Ward	The well log indicates that water from the well is used for drinking so it was considered not to be a Rustler Formation well.

Table 4.3.2 Number of wells with water-level data and number of water-level measurements for wells completed into the Rustler Aquifer or Rustler Formation.

County	Number of Rustler Wells with Water-Level Data	Number of Rustler Water-Level Measurements
Crane	1	19
Culberson	20	52
Brewster	0	0
Jeff Davis	0	0
Loving	1	1
Pecos	22	125
Reeves	30	89
Ward	15	27
Winkler	6	6
Total	95	319

Table 4.3.3 Number of wells completed into the Rustler Aquifer or Rustler Formation by decade.

Decade	Number of Wells
unknown ¹	32
1920s	2
1930s	3
1940s	11
1950s	37
1960s	6
1970s	3
1980s	1
1990s	0
2000s	0

¹ completion/drilled data not report

Final Groundwater Availability Model for the Rustler Aquifer

Table 4.3.4 Pre-development water-level elevations for the Rustler Aquifer and Rustler Formation.

State Well Number	County Report Well Number	County	Aquifer Code	Water-Bearing Unit	Date	Ground Surface Elevation (feet)	Depth to Water ¹ (feet)	Water-Level Elevation (feet)	Comments	Source
4558502		Pecos	312RSLR		1946	2665.00	flows	2665.00	Water-level elevation set equal to ground surface elevation.	TWDB (2010c) remarks table
	N-1	Pecos		Rustler Formation	1933	2962.74	flows	2962.74	Ground surface elevation taken from Digital Elevation Model. Water-level elevation set equal to ground surface elevation.	Armstrong and McMillion (1961)
	P-134	Pecos		Rustler Formation	4/3/46	3100.00	flows	3100.00	Water-level elevation set equal to ground surface elevation.	Armstrong and McMillion (1961)
	P-95	Pecos		Rustler Formation	1939	3071.00	flows	3071.00	Water-level elevation set equal to ground surface elevation.	Armstrong and McMillion (1961)
	Q-300	Pecos		Rustler Formation	6/23/47	3009.00	flows	3009.00	Water-level elevation set equal to ground surface elevation.	Armstrong and McMillion (1961)
	Q-9	Pecos		Rustler Formation	6/22/49	2857.75	flows	2857.75	Ground surface elevation taken from Digital Elevation Model. Water-level elevation set equal to ground surface elevation.	Armstrong and McMillion (1961)
4542603		Ward	312RSLR		5/15/40	2412.00	1	2413.00		TWDB (2010c)
4638601		Ward	312RSLR		1923	2550.00	flows	2550.00	Water-level elevation set equal to ground surface elevation.	TWDB (2010c) remarks table
4640702		Ward	312RSLR		1948	2494.00	flows	2494.00	Water-level elevation set equal to ground surface elevation.	TWDB (2010c) remarks table
4640801		Ward	312RSLR		1932	2481.00	flows	2481.00	Water-level elevation set equal to ground surface elevation.	TWDB (2010c) remarks table

¹ negative value denotes water level below ground surface and positive value denotes water level above ground surface; flows indicates well was flowing but height of water level above ground surface was not recorded

TWDB = Texas Water Development Board

Final Groundwater Availability Model for the Rustler Aquifer

Table 4.3.5 Comparison of average 1980, 1990, and 1997 water-level elevations.

Well Number	County	Site Number on Figures 4.3.9 through 4.3.11	Average 1980 Water-Level Elevation (feet)	Average 1990 Water-Level Elevation (feet)	Average 1997 Water-Level Elevation (feet)	1980 to 1990 Change	1990 to 1997 Change	1980 to 1997 Change
4544601	Crane	1	2300	2323	2320	23-foot increase	3-foot decrease	20-foot increase
4723501 ^a	Culberson		na	3368	na			
4723601 ^a	Culberson		na	3233	na			
4723602 ^a	Culberson		na	3257	na			
4723801 ^a	Culberson		na	3305	na			
4754201	Culberson	2	na	3685	3687		3-foot increase	
4754203	Culberson	3	na	3675	3675		stable	
4754206	Culberson	4	3685	na	3691			6-foot increase
4754207	Culberson	5	3680	3547	3547	133-foot decrease	stable	133-foot decrease
4754302	Culberson	6	na	3527	3528		2-foot increase	
4613402 ^a	Loving		2580	na	na			
5216608	Pecos	7	3011	3054	3072	43-foot increase	18-foot increase	61-foot increase
5216609	Pecos	8	3003	3045	3070	42-foot increase	25-foot increase	67-foot increase
4653903 ^a	Reeves		na	2662	na			
4654802 ^a	Reeves		na	2617	na			
4654901 ^a	Reeves		na	2619	na			
4660202 ^a	Reeves		na	2602	na			

Final Groundwater Availability Model for the Rustler Aquifer

Table 4.3.5, continued

Well Number	County	Site Number on Figures 4.3.9 through 4.3.11	Average 1980 Water-Level Elevation (feet)	Average 1990 Water-Level Elevation (feet)	Average 1997 Water-Level Elevation (feet)	1980 to 1990 Change	1990 to 1997 Change	1980 to 1997 Change
4660902	Reeves	9	2687	2698	2696	11-foot increase	2-foot decrease	9-foot increase
5204211 ^a	Reeves		na	2817.01	na			
4640702 ^a	Ward		na	flowing	flowing			
4640703 ^a	Ward		na	flowing	flowing			
4640801 ^a	Ward		na	flowing	flowing			
320518104031000	Eddy	10	2851	2855	2844	4-foot increase	11-foot decrease	7-foot decrease

^a insufficient data to make comparisons
na = water-level data not available for this time

Final Groundwater Availability Model for the Rustler Aquifer

Table 4.3.6 Summary of water-level data for wells completed into the Rustler Aquifer or Rustler Formation.

State Well Number	Well Number in County Report	County	Year of First Water-Level Measurement	Year of Last Water-Level Measurement	Number of Water-Level Measurements
4544601		Crane	1974	1993	19
4723501		Culberson	1988	1988	1
4723601		Culberson	1988	1988	1
4723602		Culberson	1986	1988	2
4723801		Culberson	1988	1988	1
4746101		Culberson	1960	1960	1
4746602		Culberson	1970	1970	1
4747401		Culberson	1970	1970	1
4747402		Culberson	1970	1970	1
4747403		Culberson	1970	1970	1
4747404		Culberson	1970	1970	1
4747701		Culberson	1970	1970	1
4747801		Culberson	1970	1970	1
4747902		Culberson	1970	1970	1
4754201		Culberson	1960	2009	17
4754202		Culberson	1970	1970	1
4754203		Culberson	1995	1955	1
4754206		Culberson	1977	2002	2
4754207		Culberson	1977	1995	2
4754302		Culberson	1970	2008	14
4755304		Culberson	1970	1970	1
4613402		Loving	1981	1981	1
4541603		Pecos	1956	1956	1
4558502		Pecos	1946	1946	1
4559501		Pecos	1950	1957	2
4655604		Pecos	1956	1959	3
5216608		Pecos	1964	2002	45
5216609		Pecos	1964	2008	52
5301201		Pecos	1956	1956	1
5301203		Pecos	1946	1946	1
5302418		Pecos	1956	1956	1
	B-22	Pecos	1956	1956	1
	G-25	Pecos	1959	1959	1
	J-8	Pecos	1957	1957	1
	J-39	Pecos	1958	1958	1
	N-1	Pecos	1933	1946	3
	P-85	Pecos	1952	1952	1
	P-86	Pecos	1956	1956	1
	P-95	Pecos	1939	1948	3
	P-134	Pecos	1946	1946	1

Final Groundwater Availability Model for the Rustler Aquifer

Table 4.3.6, continued

State Well Number	Well Number in County Report	County	Year of First Water-Level Measurement	Year of Last Water-Level Measurement	Number of Water-Level Measurements
	Q-9	Pecos	1949	1949	1
	Q-300	Pecos	1947	1956	2
	Z-71	Pecos	1957	1957	1
	AA-6	Pecos	1958	1958	1
4653903		Reeves	1988	1988	1
4654802		Reeves	1988	1989	2
4654901		Reeves	1988	1989	2
4660202		Reeves	1959	1987	3
4660902		Reeves	1959	2004	39
4660904		Reeves	1959	1960	3
5204211		Reeves	1988	1989	2
5204302		Reeves	1958	1970	5
	A-18	Reeves	1959	1959	1
	A-21	Reeves	1959	1959	1
	Q-326	Reeves	1959	1959	2
	R-32	Reeves	1959	1959	1
	R-33	Reeves	1959	1959	1
	R-39	Reeves	1959	1960	2
	S-14	Reeves	not reported		1
	S-39	Reeves	1959	1959	2
	S-40	Reeves	1959	1959	1
	S-51	Reeves	1959	1959	1
	S-62	Reeves	1958	1959	2
	S-66	Reeves	1958	1959	2
	S-81	Reeves	1959	1960	2
	V-18	Reeves	1959	1959	1
	V-25	Reeves	1959	1959	1
	W-12	Reeves	1959	1959	1
	W-53	Reeves	1959	1959	1
	W-60	Reeves	1959	1959	1
	W-81	Reeves	1959	1959	1
	W-96	Reeves	1959	1959	3
	W-117	Reeves	1959	1960	2
	W-120	Reeves	1959	1960	2
4517910		Ward	1959	1959	1
4533906		Ward	1967	1967	1
4533910		Ward	1967	1967	1
4533912		Ward	1958	1967	2
4534703		Ward	1957	1957	1
4541302		Ward	1967	1967	1
4542603		Ward	1940	1967	2
4542802		Ward	1967	1967	1

Final Groundwater Availability Model for the Rustler Aquifer

Table 4.3.6, continued

State Well Number	Well Number in County Report	County	Year of First Water-Level Measurement	Year of Last Water-Level Measurement	Number of Water-Level Measurements
4630601		Ward	1967	1967	1
4638601 ^a		Ward	1923	1967	4
4640702 ^a		Ward	1948	1995	4
4640703 ^a		Ward	1959	1995	3
4640705		Ward	1967	1967	1
4640706		Ward	1967	1967	1
4640801 ^a		Ward	1932	1995	3
4517802		Winkler	1967	1967	1
	D-156	Winkler	1954	1954	1
	D-160	Winkler	1954	1954	1
	D-195	Winkler	1956	1956	1
	D-210	Winkler	1957	1957	1
	D-213	Winkler	1956	1956	1

^a well observed to be flowing for all measurements

Final Groundwater Availability Model for the Rustler Aquifer

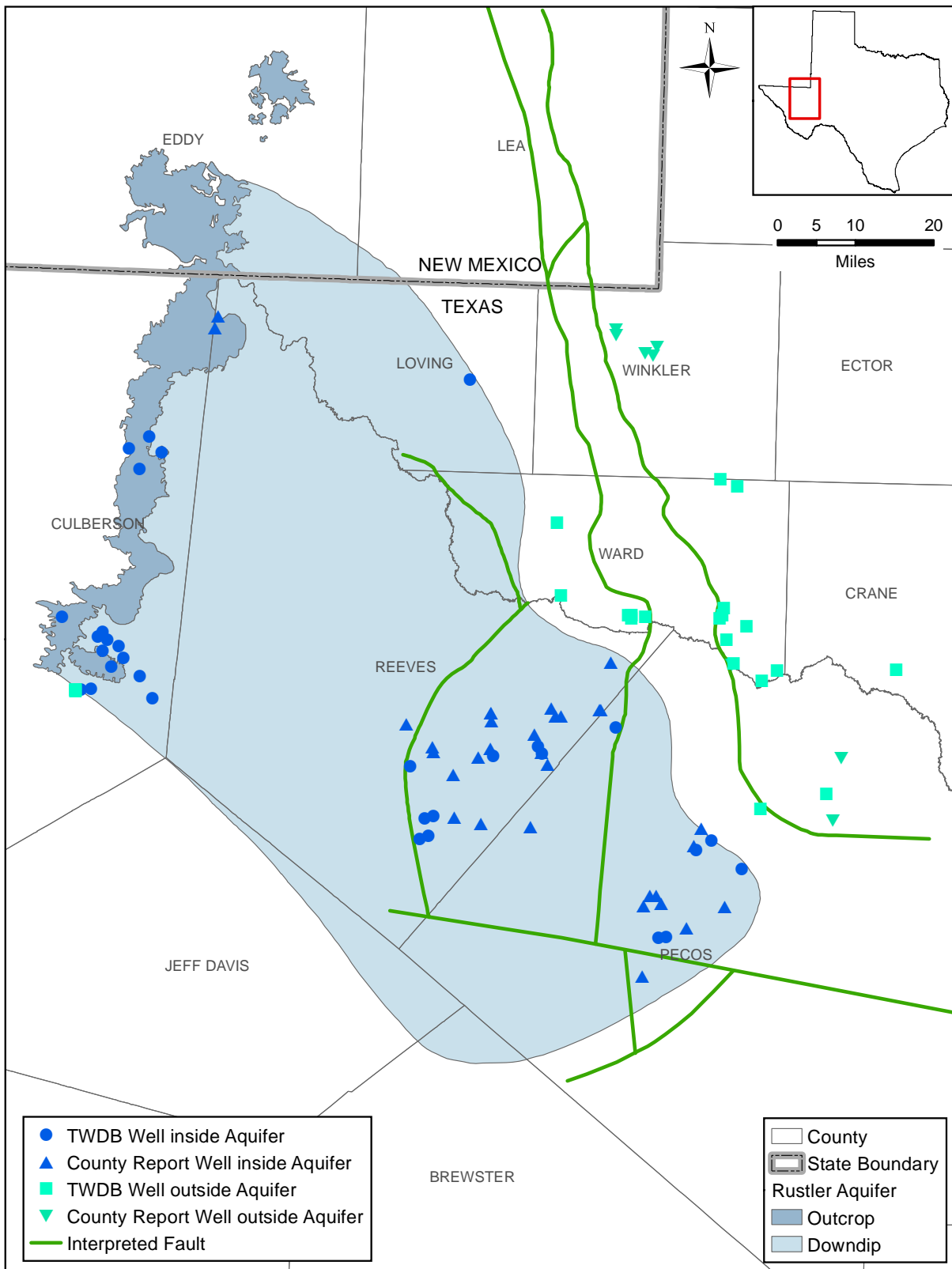

Figure 4.3.1 Water-level measurement locations for the Rustler Aquifer and Rustler Formation in Texas (TWDB, 2010c).

Final Groundwater Availability Model for the Rustler Aquifer

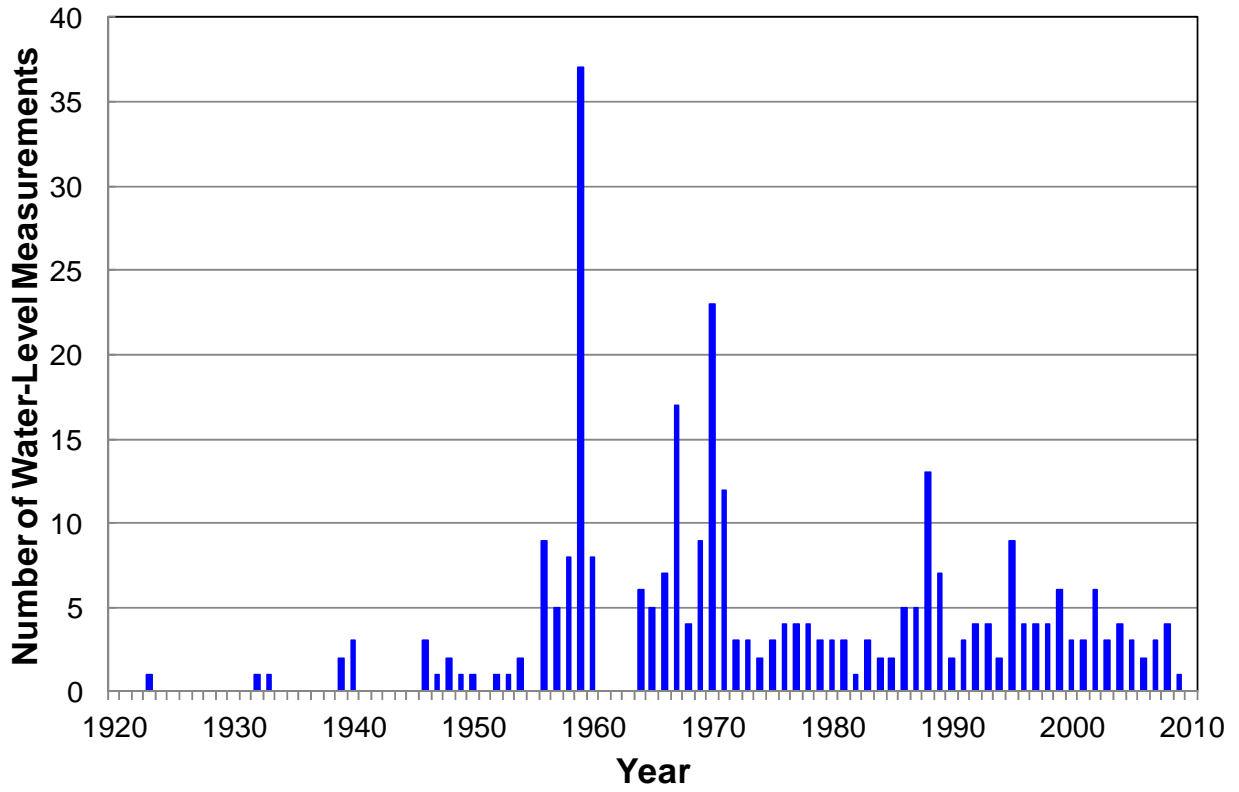

Figure 4.3.2 Temporal distribution of water-level measurements in the Rustler Aquifer and Rustler Formation (TWDB, 2010c).

Final Groundwater Availability Model for the Rustler Aquifer

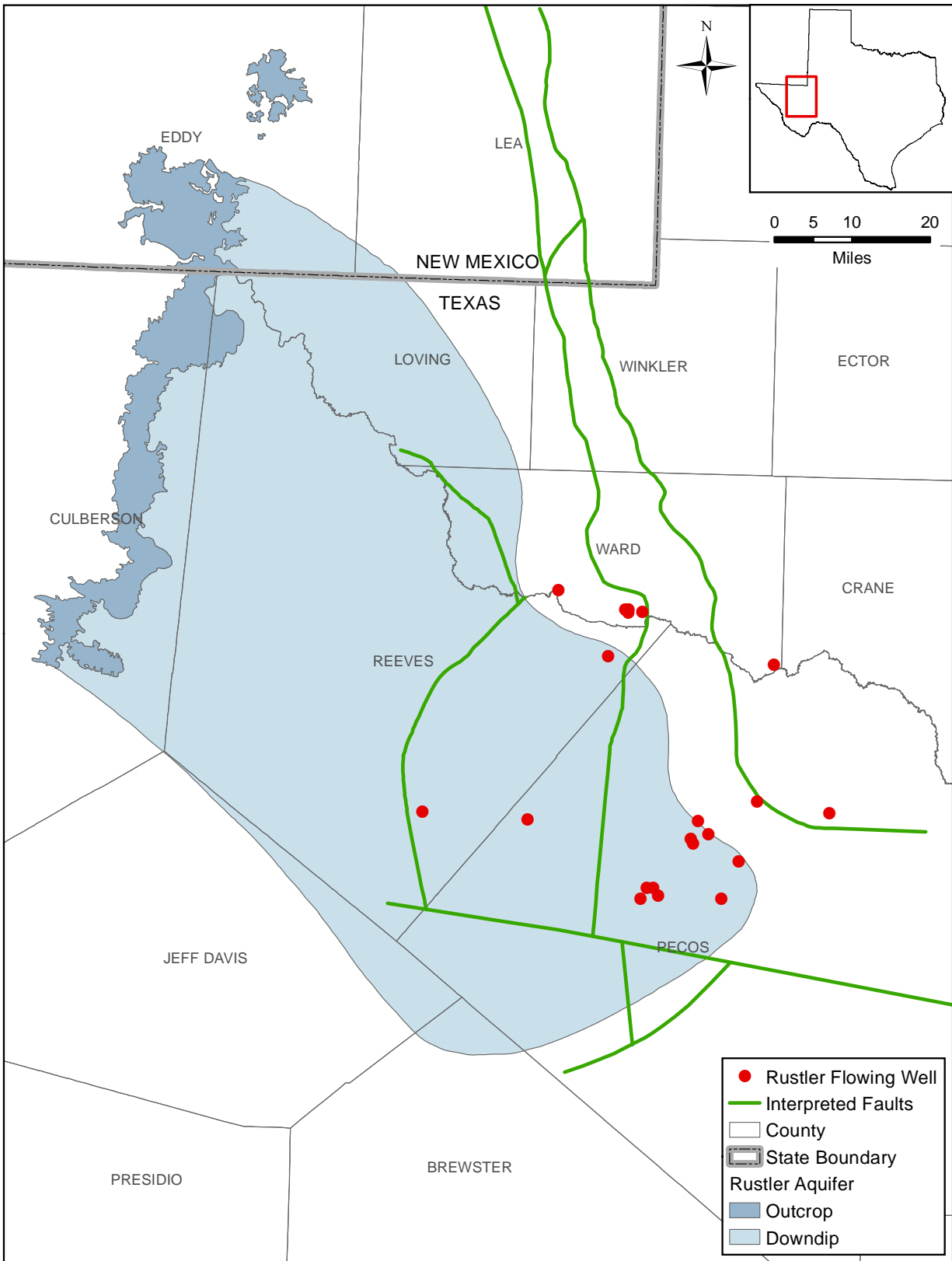

Figure 4.3.3 Locations of Rustler Aquifer and Rustler Formation wells that once flowed (TWDB, 2010c).

Final Groundwater Availability Model for the Rustler Aquifer

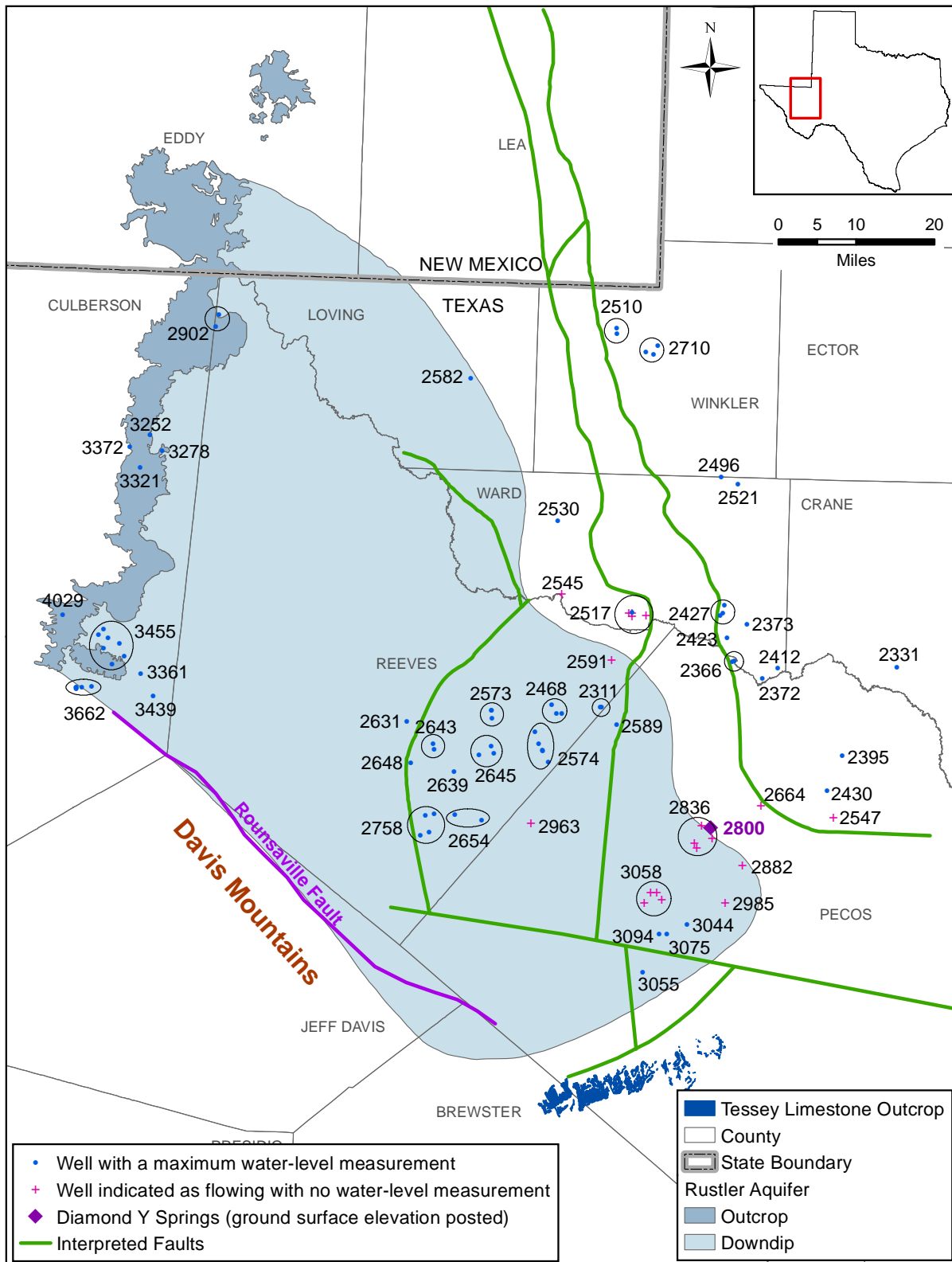

Figure 4.3.4 Posted maximum water-level elevation (in feet above mean sea level), or ground surface elevation (in feet above mean sea level) for flowing wells, for wells completed into the Rustler Formation (Sharp and others, 2003; TWDB, 2010c).

Final Groundwater Availability Model for the Rustler Aquifer

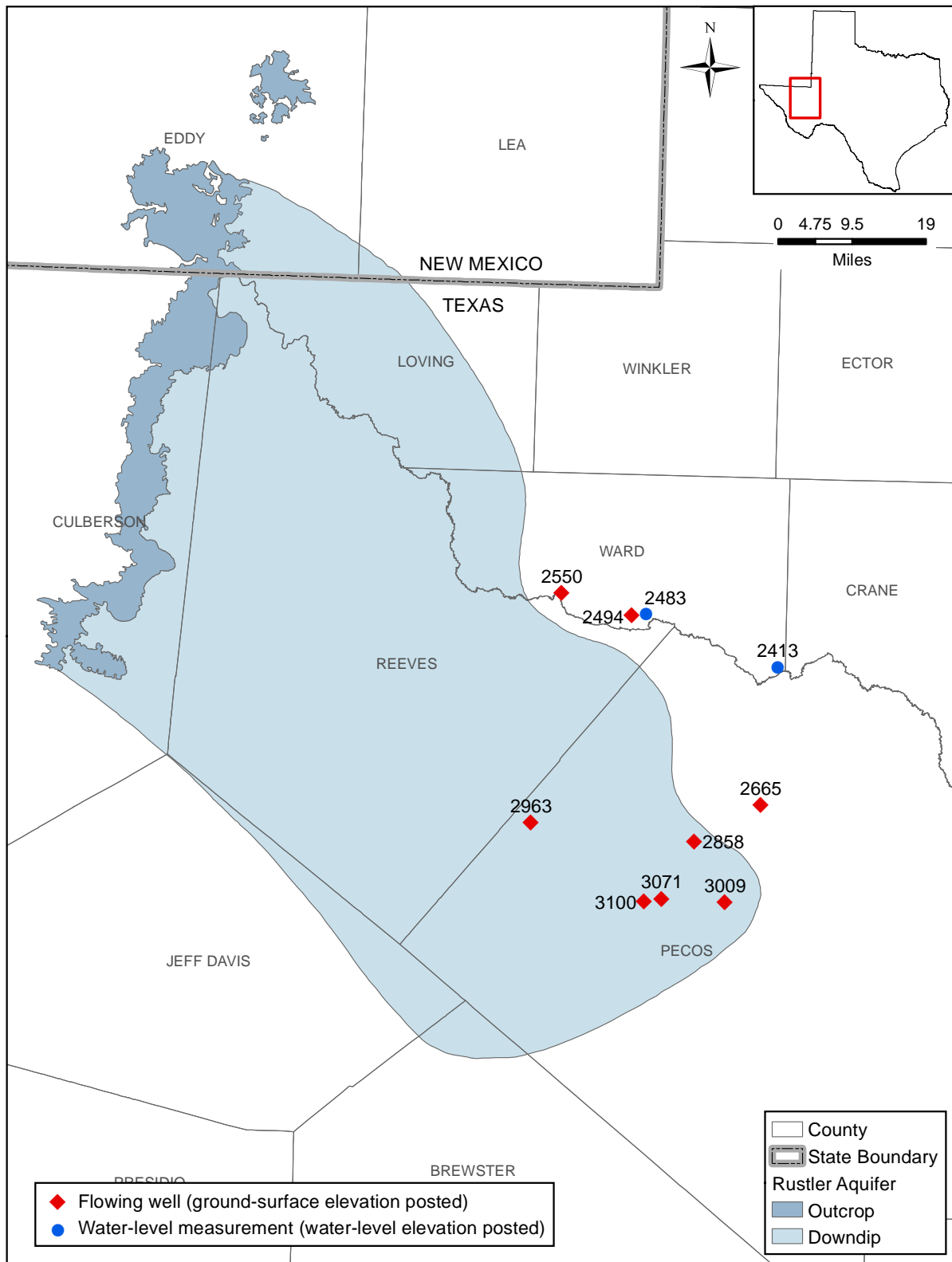

Figure 4.3.5 Estimated pre-development water-level elevations (in feet above mean sea level) for the Rustler Aquifer and Rustler Formation (TWDB, 2010c).

Final Groundwater Availability Model for the Rustler Aquifer

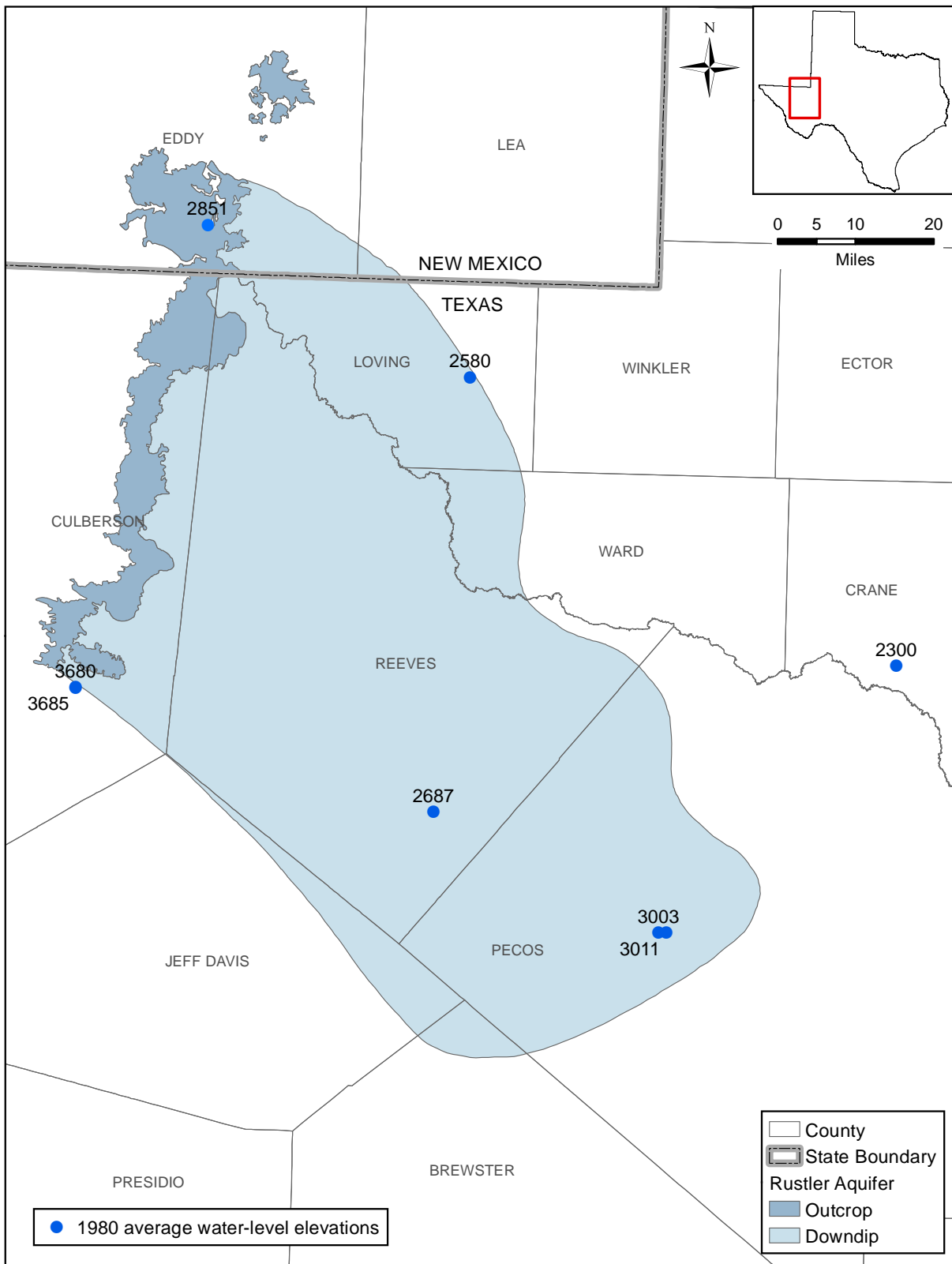

Figure 4.3.6 Estimated water-level elevations (in feet above mean sea level) in the Rustler Aquifer and Rustler Formation for January 1980 (Bowman, 2010; TWDB, 2010c).

Final Groundwater Availability Model for the Rustler Aquifer

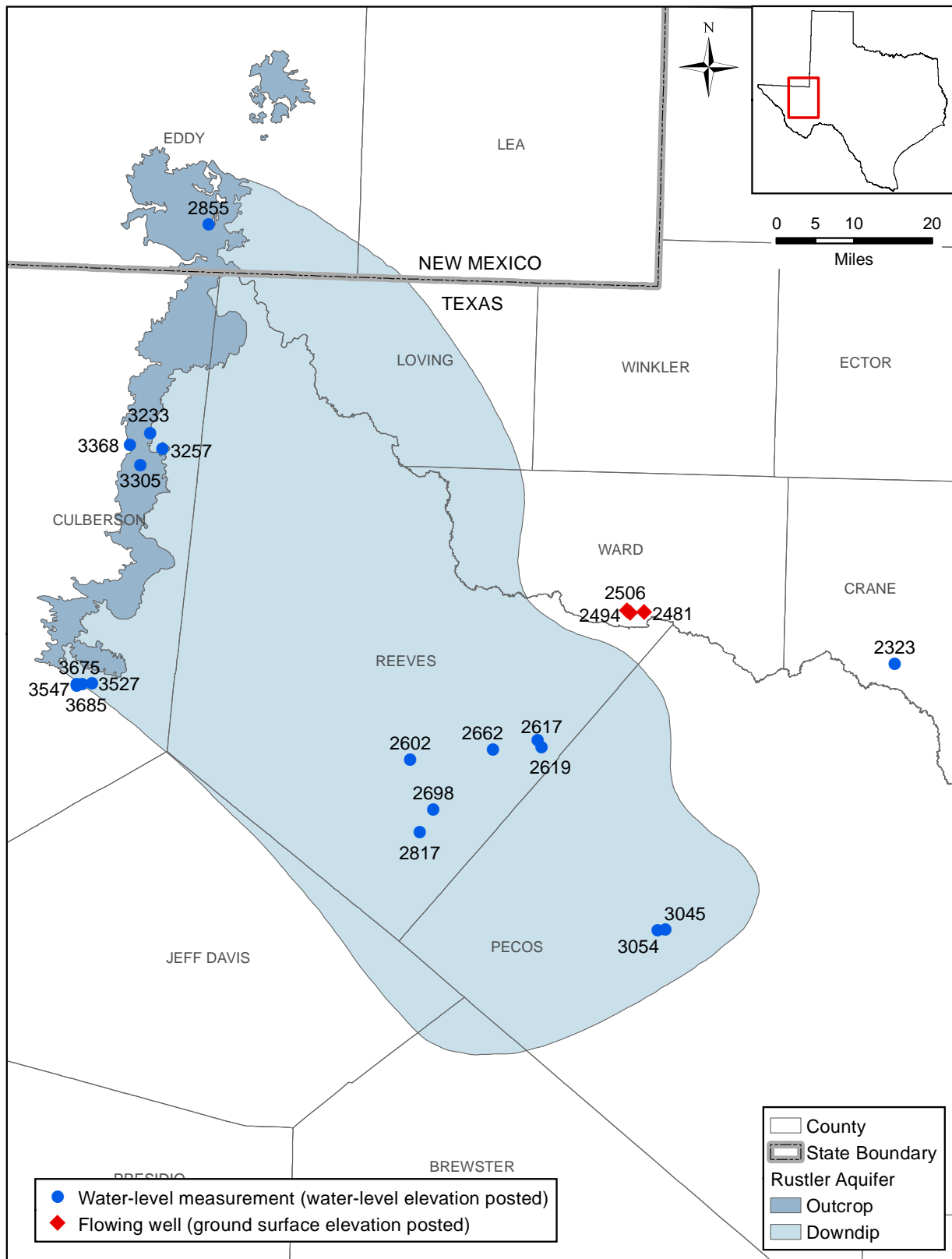

Figure 4.3.7 Estimated water-level elevations (in feet above mean sea level) in the Rustler Aquifer and Rustler Formation for January 1990 (Bowman, 2010; TWDB, 2010c).

Final Groundwater Availability Model for the Rustler Aquifer

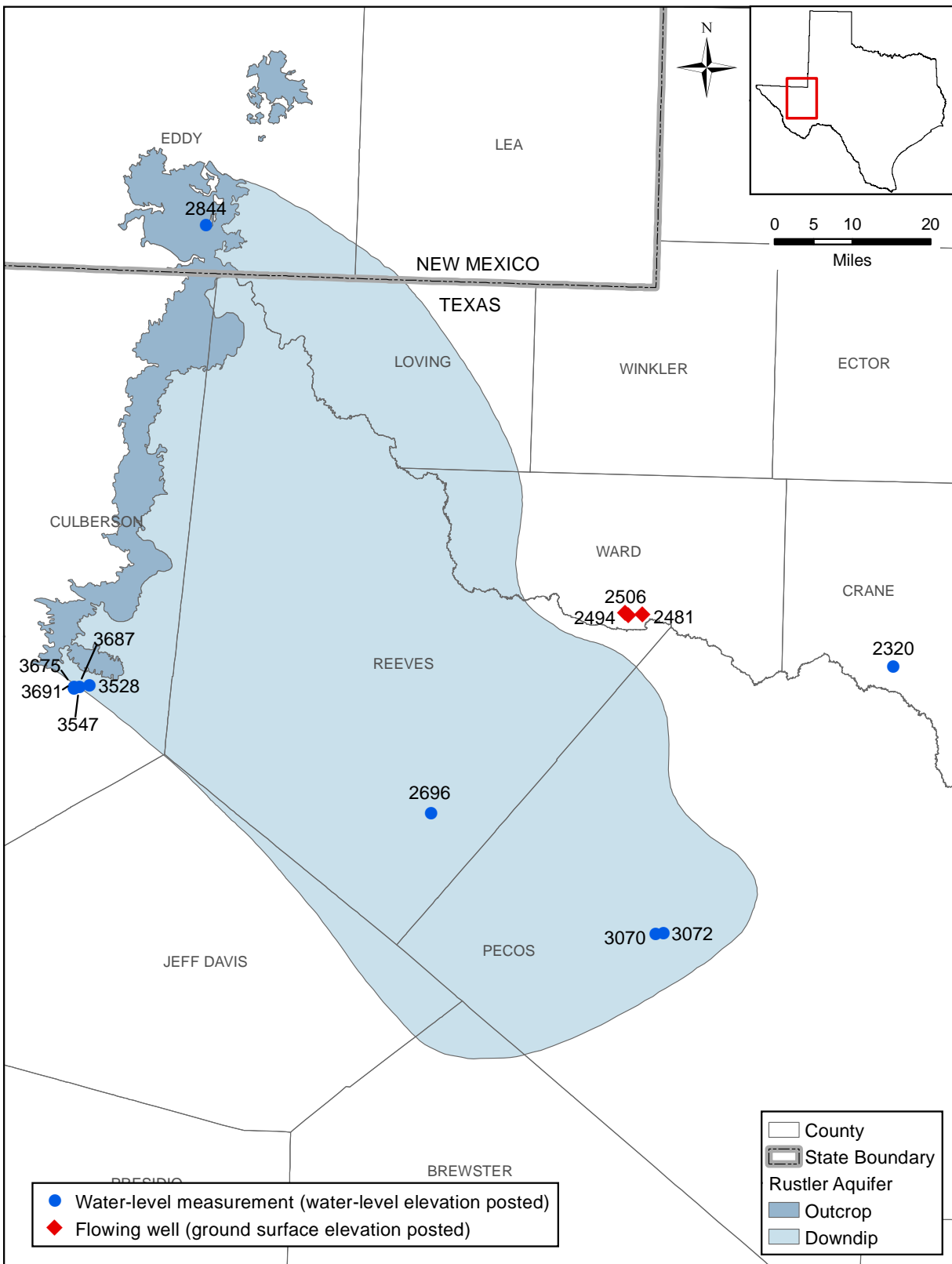

Figure 4.3.8 Estimated water-level elevations (in feet above mean sea level) in the Rustler Aquifer and Rustler Formation for December 1997 (Bowman, 2010; TWDB, 2010c).

Final Groundwater Availability Model for the Rustler Aquifer

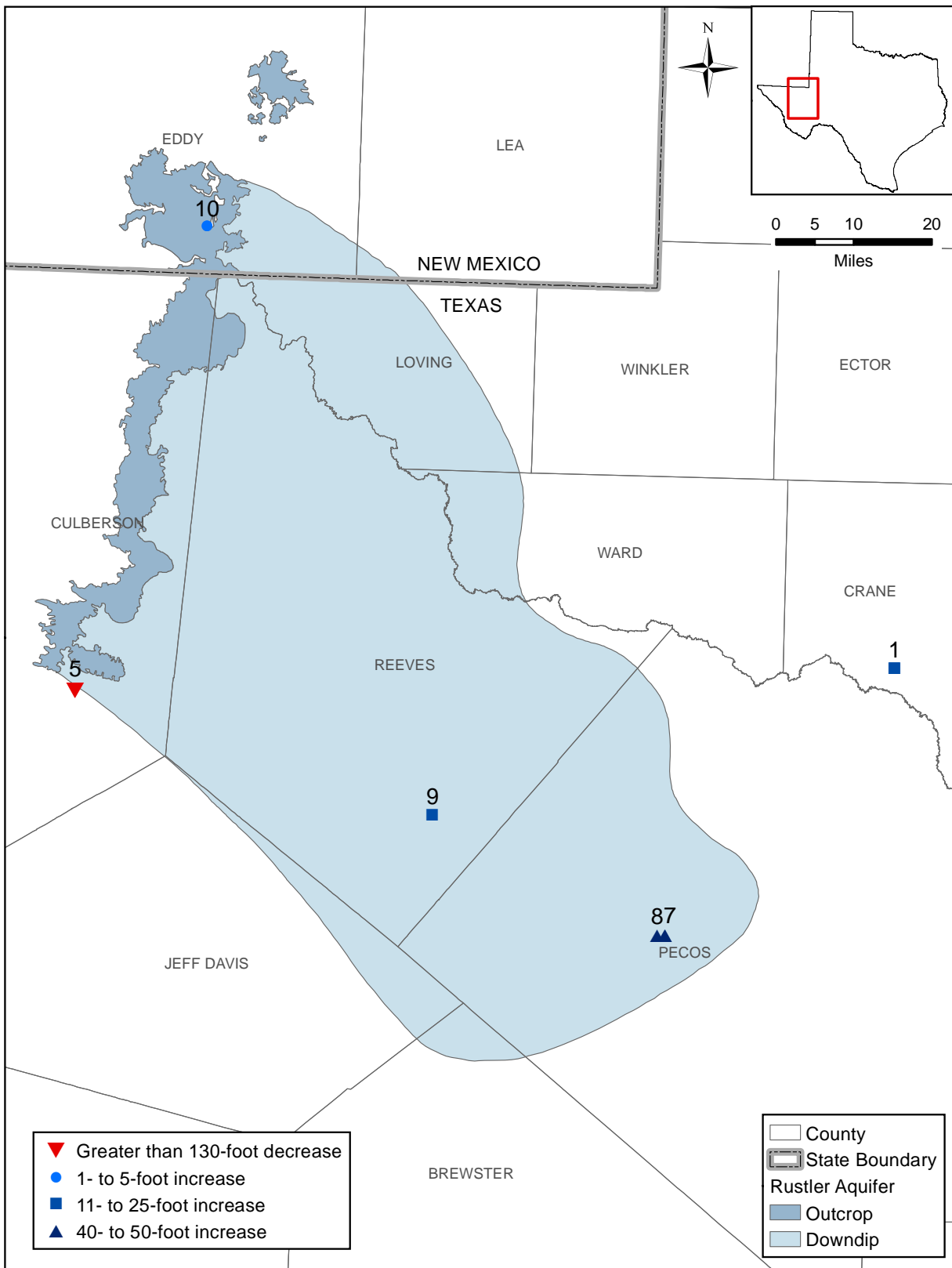

Figure 4.3.9 Trend in water-level elevation in the Rustler Aquifer and Rustler Formation from 1980 to 1990 (Bowman, 2010; TWDB, 2010c). Posted value indicates site number as given in Table 4.3.5.

Final Groundwater Availability Model for the Rustler Aquifer

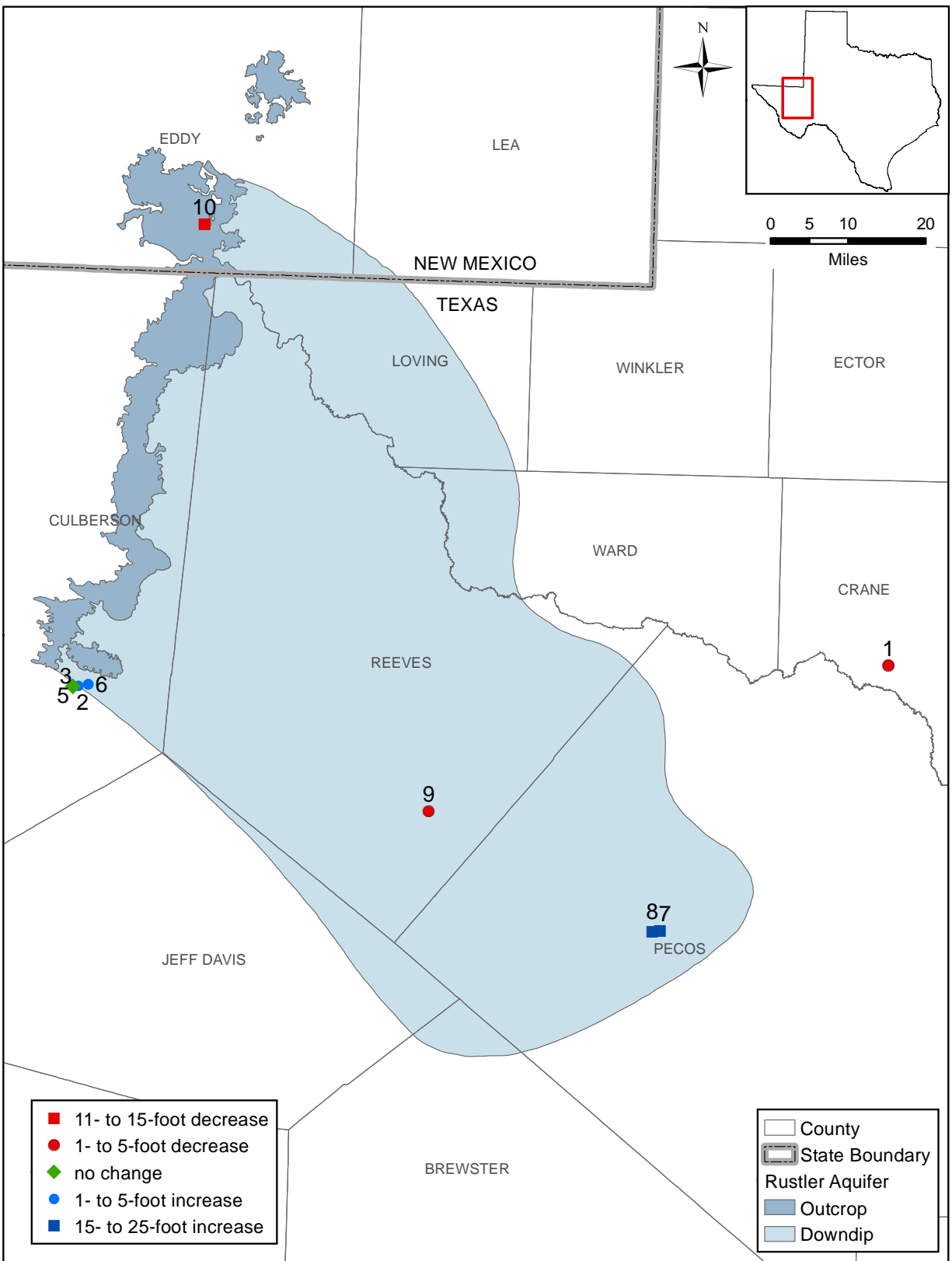

Figure 4.3.10 Trend in water-level elevation in the Rustler Aquifer and Rustler Formation from 1990 to 1997 (Bowman, 2010; TWDB, 2010c). Posted value indicates site number as given in Table 4.3.5.

Final Groundwater Availability Model for the Rustler Aquifer

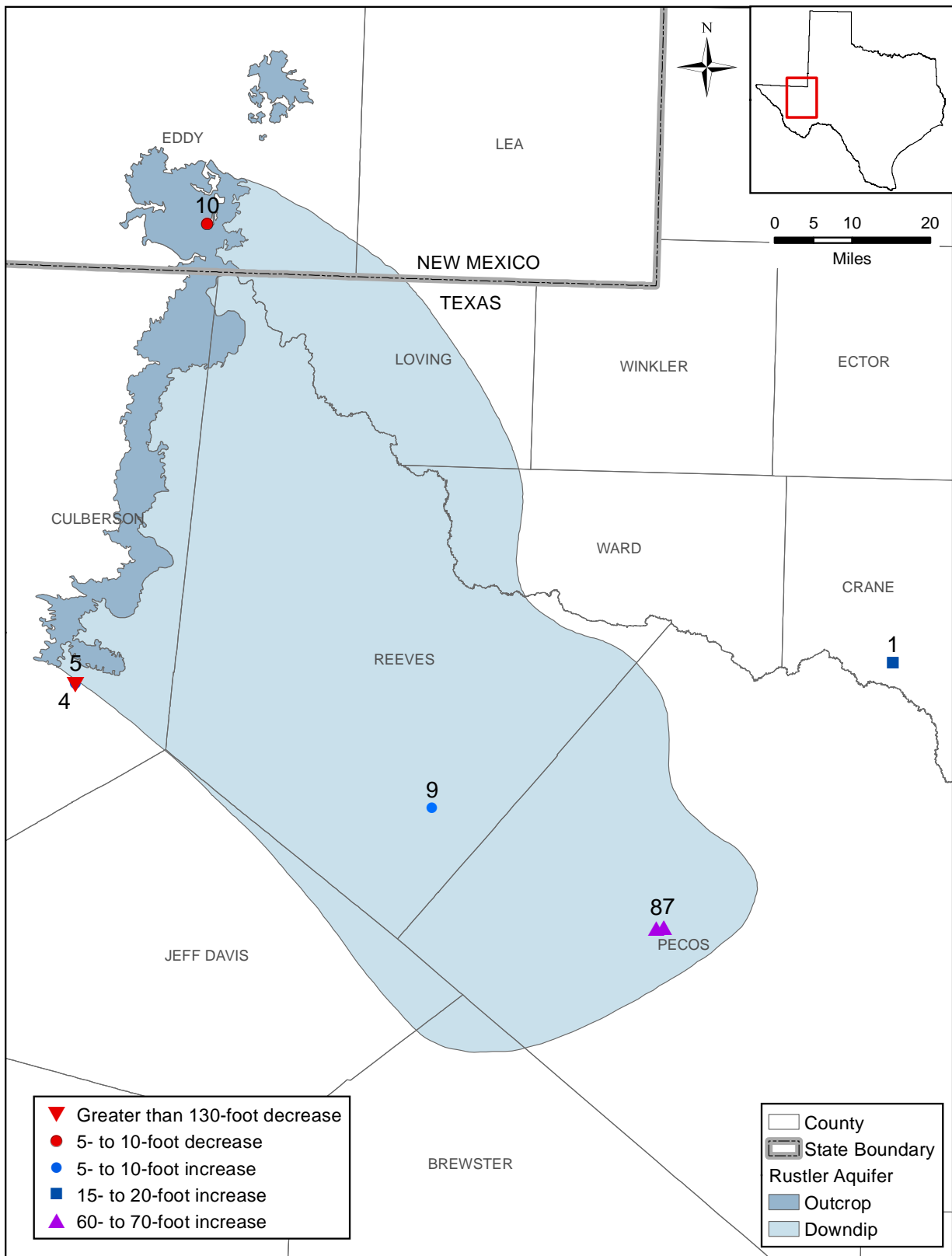

Figure 4.3.11 Overall trend in water-level elevation in the Rustler Aquifer and Rustler Formation from 1980 to 1997 (Bowman, 2010; TWDB, 2010c). Posted value indicates site number as given in Table 4.3.5.

Final Groundwater Availability Model for the Rustler Aquifer

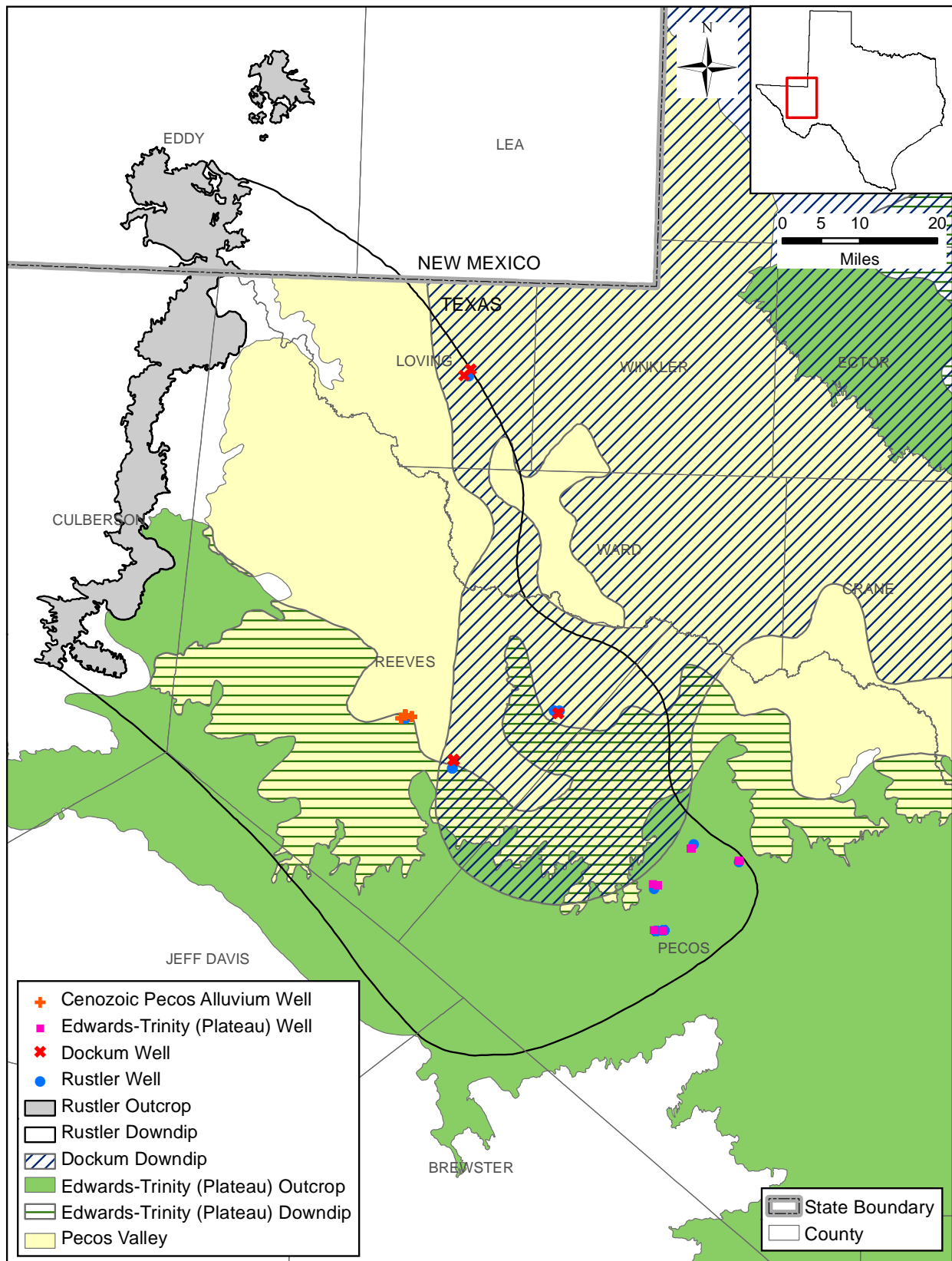
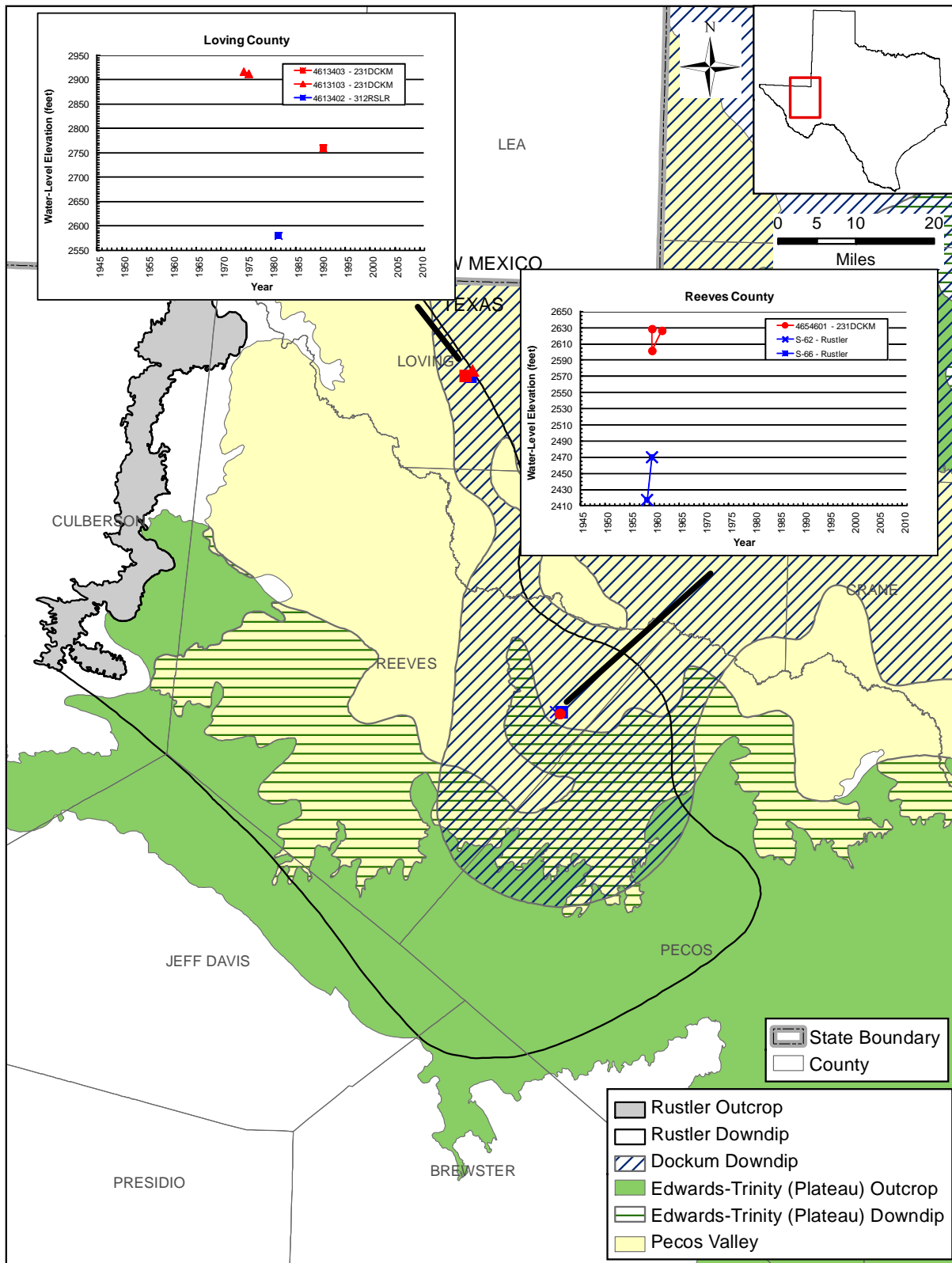

Figure 4.3.12 Locations of aquifers overlying the Rustler Aquifer and locations of wells used for comparing water-level elevations between aquifers (TWDB, 2006a, 2006b, 2010c).

Final Groundwater Availability Model for the Rustler Aquifer



231DCKM = Dockum Aquifer

Figure 4.3.13 Comparison of water-level elevations (in feet above mean sea level) in the Rustler and Dockum aquifers (TWDB, 2006a, 2006b, 2010c).

Final Groundwater Availability Model for the Rustler Aquifer

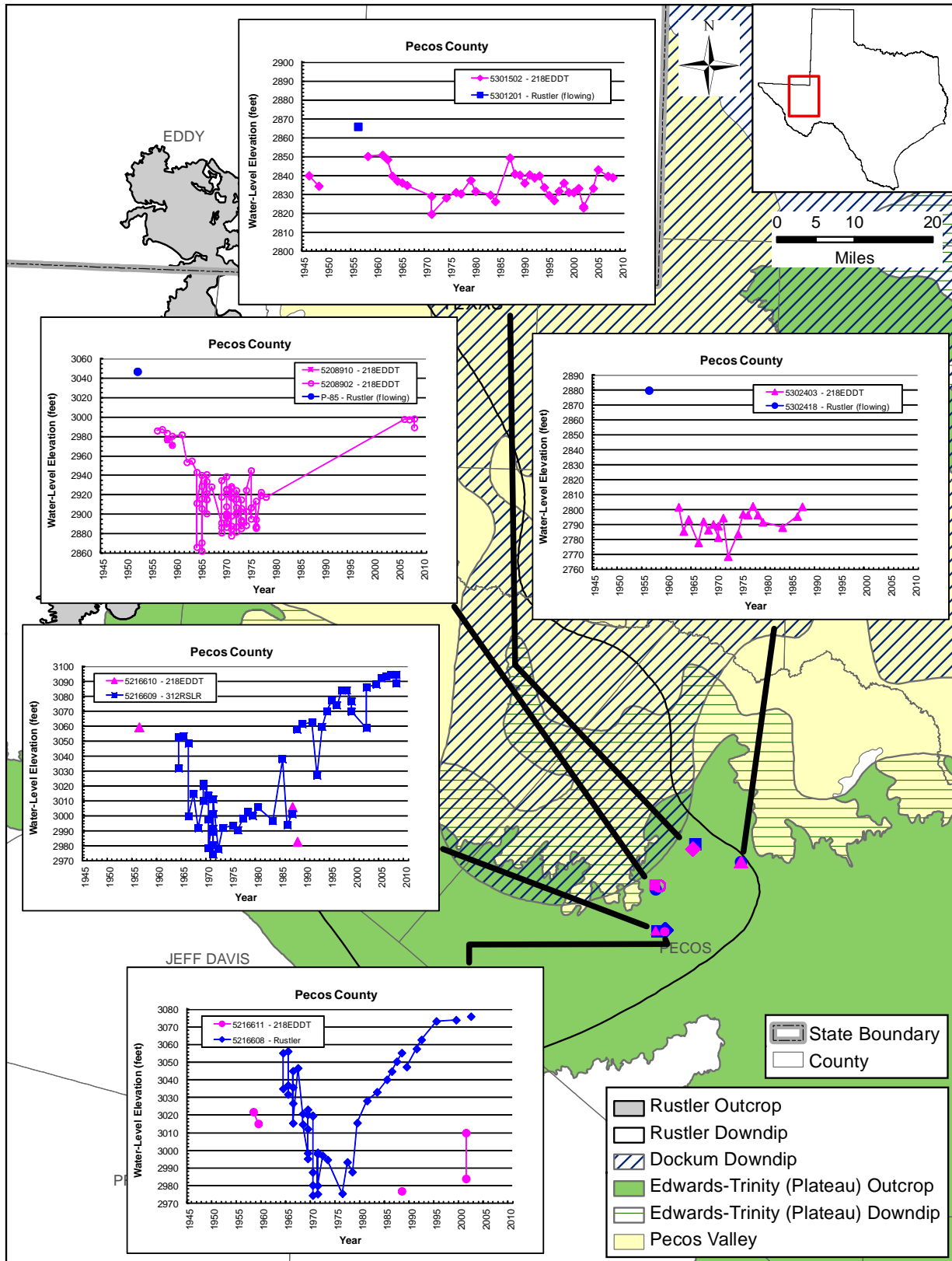

218EDDT = Edwards-Trinity (Plateau) Aquifer

Figure 4.3.14 Comparison of water-level elevations (in feet above mean sea level) in the Rustler and Edwards-Trinity (Plateau) aquifers (TWDB, 2006a, 2006b, 2010c).

Final Groundwater Availability Model for the Rustler Aquifer

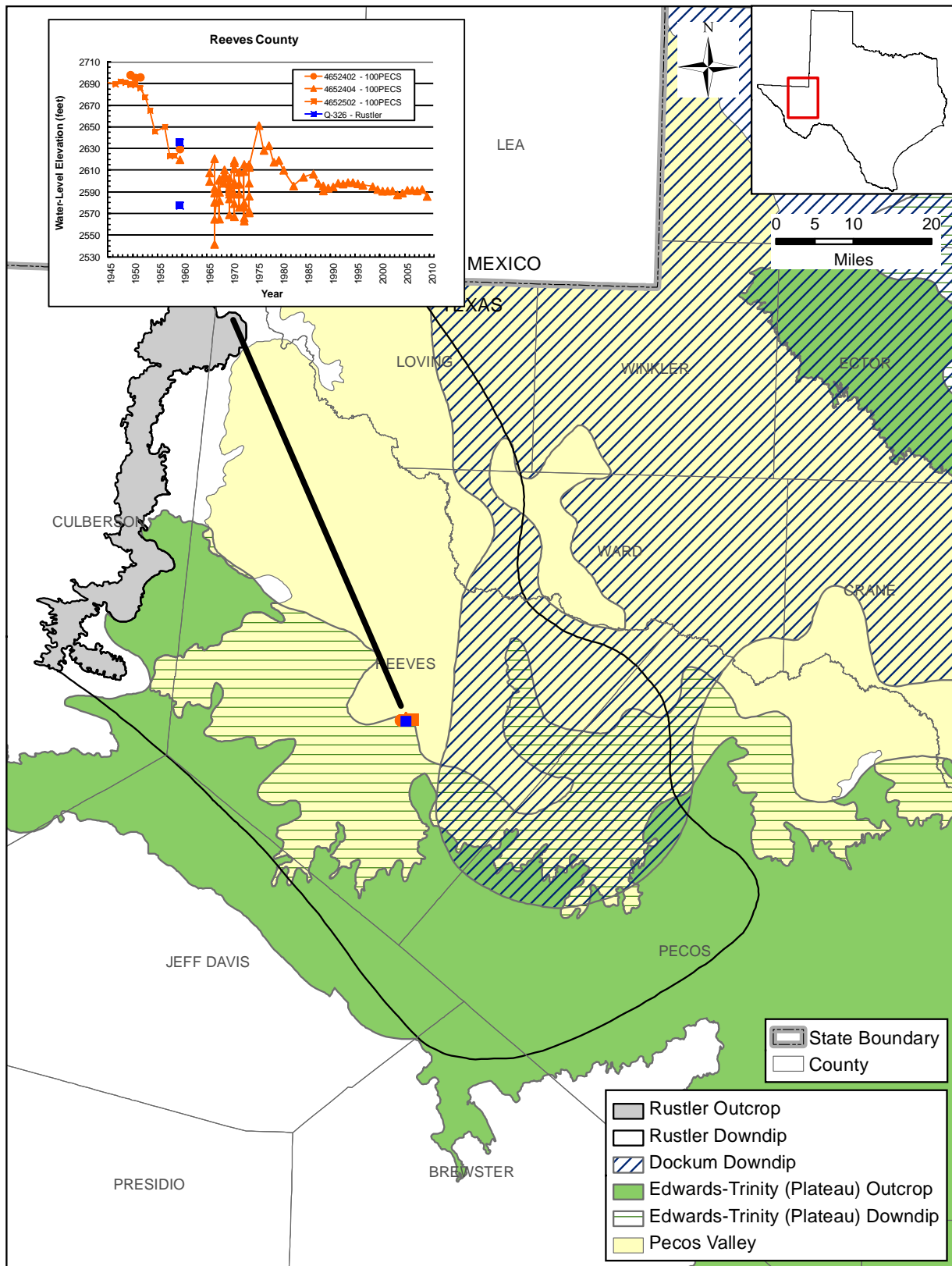

100PECS = Pecos Valley Aquifer

Figure 4.3.15 Comparison of water-level elevations (in feet above mean sea level) in the Rustler and Pecos Valley aquifers (TWDB, 2006a, 2006b, 2010c).

Final Groundwater Availability Model for the Rustler Aquifer

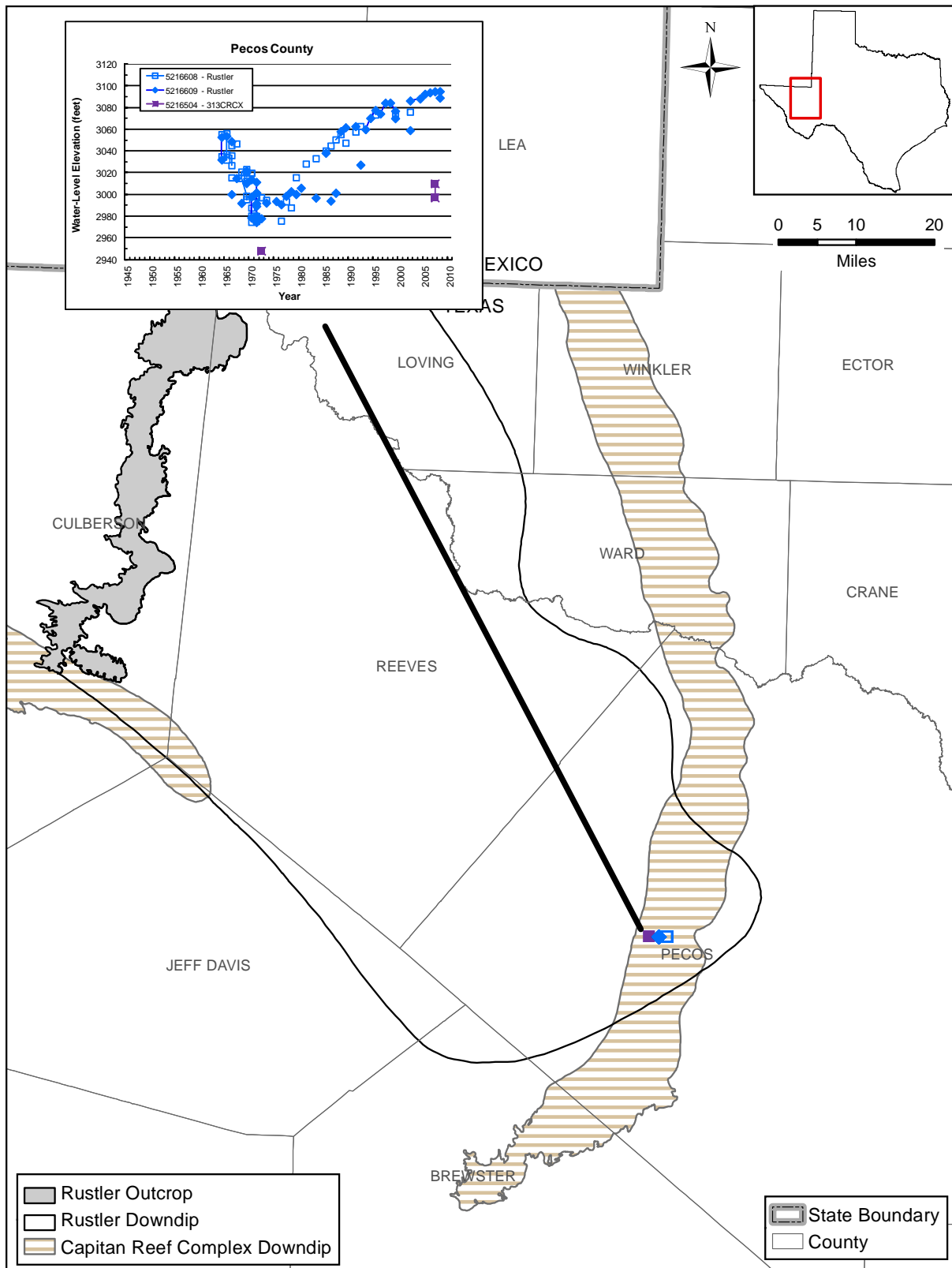

313CRCX = Capitan Reef Complex Aquifer

Figure 4.3.16 Comparison of water-level elevations (in feet above mean sea level) in the Rustler Aquifer and the underlying Capitan Reef Complex Aquifer (TWDB, 2006b, 2010c).

Final Groundwater Availability Model for the Rustler Aquifer

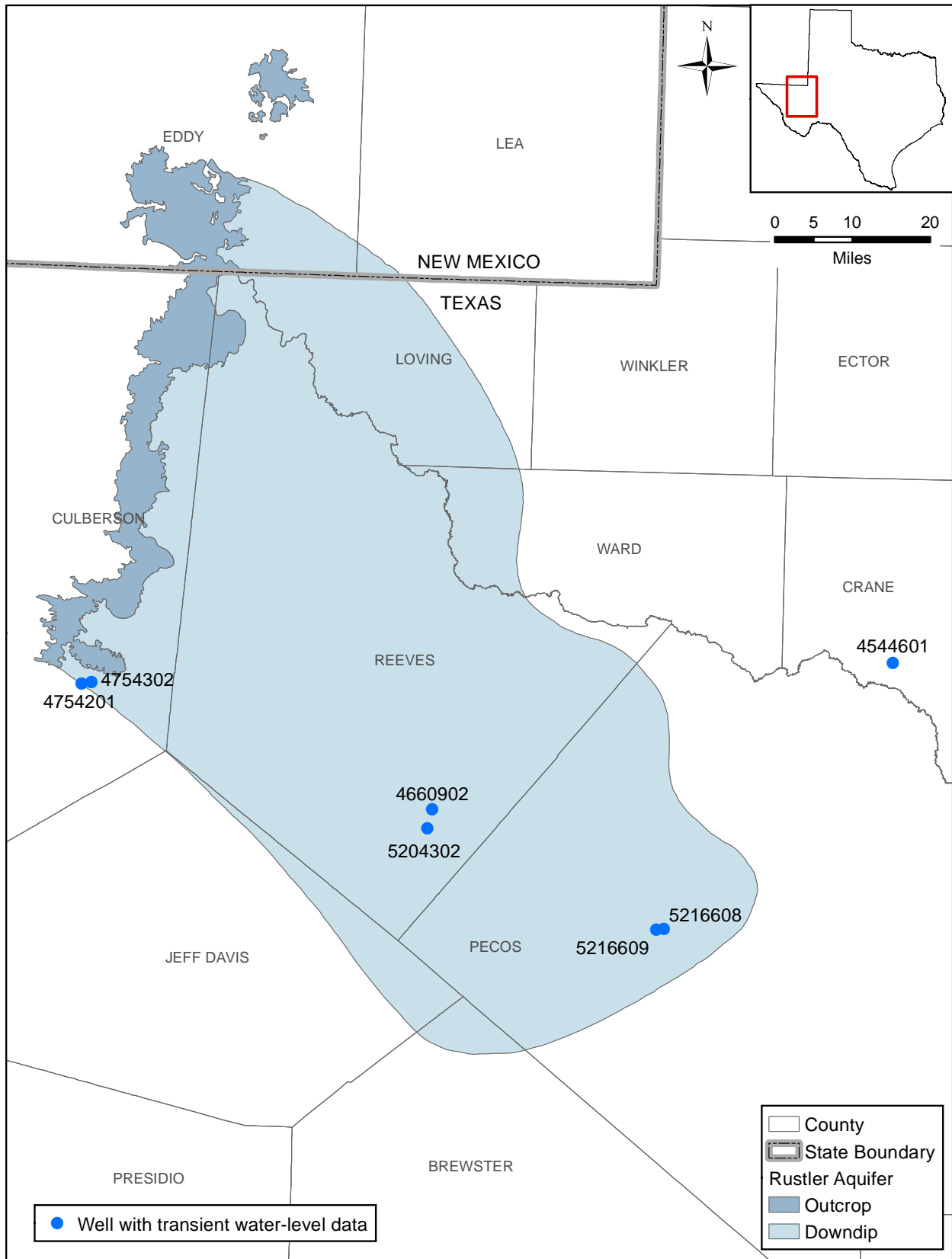

Figure 4.3.17 Locations of Rustler Aquifer and Rustler Formation wells with transient water-level data (TWDB, 2010c).

Final Groundwater Availability Model for the Rustler Aquifer

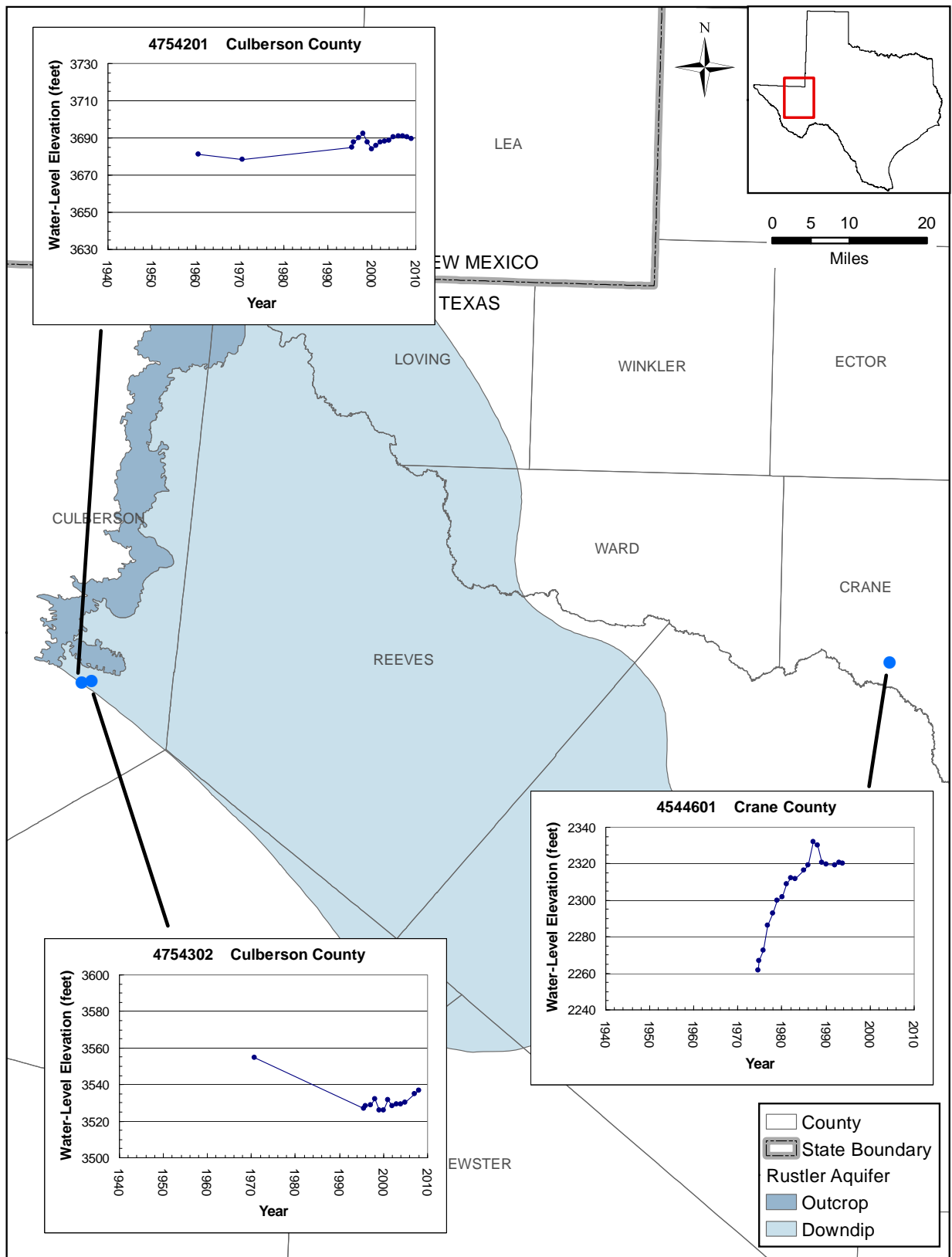

Figure 4.3.18 Hydrographs of transient water-level data (in feet above mean sea level) for Rustler Aquifer wells in Culberson County and a Rustler Formation well in Crane County (TWDB, 2010c).

Final Groundwater Availability Model for the Rustler Aquifer

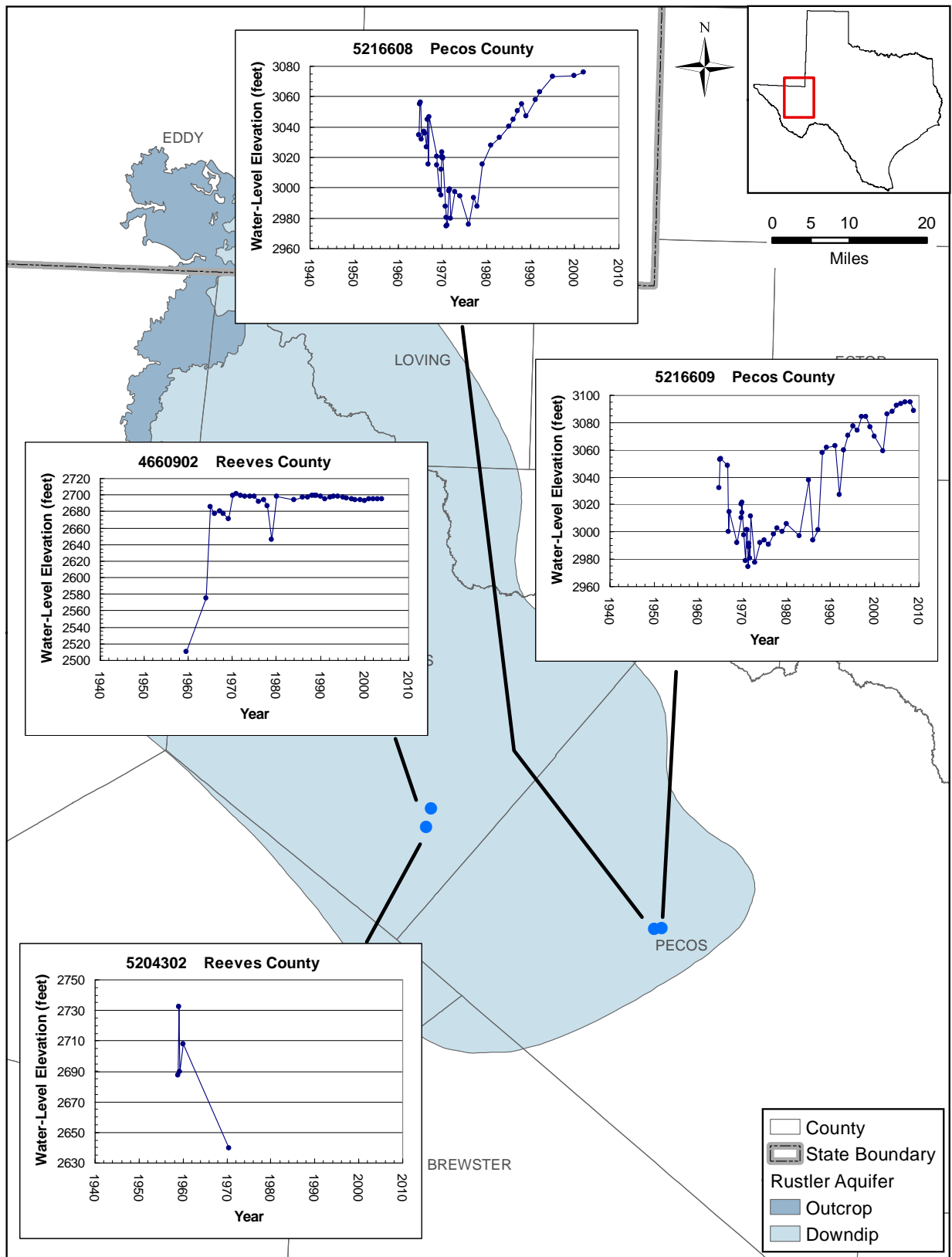

Figure 4.3.19 Hydrographs of transient water-level data (in feet above mean sea level) for Rustler Aquifer wells in Pecos and Reeves counties (TWDB, 2010c).

4.4 Recharge

Recharge can be defined as water that enters the saturated zone at the water table (Freeze, 1969). Recharge is a complex function of rate and volume of precipitation, soil type, water level, soil moisture, topography, and evapotranspiration (Freeze, 1969). Potential sources for recharge to the water table include precipitation, irrigation return flow, and stream or reservoir leakage. Precipitation and irrigation return flow are generally considered to be diffuse sources of recharge, while stream or reservoir leakage are considered to be focused sources of recharge. Man-made reservoirs in the aquifer outcrop may provide the potential for focused recharge in the active model area. An aquifer test conducted in the Rustler Formation in Eddy County, New Mexico showed some connection between Red Bluff Reservoir (see Figure 2.0.4) and the formation (Richey and others, 1985). Additional recharge likely results from cross-formational flow in the downdip section of the aquifer from the Capitan Reef Complex Aquifer to the Rustler Aquifer.

During a rainfall event (or irrigation event), some of the water may run off to small streams and surface features and some of the water infiltrates to the soil (a small fraction of the water that infiltrates to the soil may become interflow, but this process is neglected as inconsequential in this discussion). Much of the infiltrating water evaporates while still near the surface or is taken up by vegetation in the vadose zone (i.e., evapotranspiration). If enough water infiltrates to satisfy the moisture deficit of the soil and the vegetation in the vadose zone, then the remaining water will reach the water table.

The groundwater system in the outcrop can often act as a classical topographically-driven recharge/discharge system, where recharge primarily occurs in the areas of higher elevation and discharge occurs in the areas of lower elevation through streams, seeps, and groundwater evapotranspiration. The recharge to the water table that discharges relatively quickly does not have a significant impact on the deeper, confined aquifer system. Conceptually, recharge can be divided into two different types, "shallow" recharge that discharges relatively quickly through baseflow and other surficial discharge components, and "deep" recharge which moves into the confined system and exits through cross-formational flow or pumping.

The Rustler Aquifer outcrops in two main areas: in a belt striking almost north from eastern Culberson County through to an island of outcrop in Eddy County, New Mexico and in southern

Pecos County and northeastern Brewster County in the Glass Mountains. In the western outcrop belt, the Rustler Formation as it is formally described (Vine, 1963) is at surface. In the southern outcrop area, a facies equivalent to the Rustler Formation (Tessey Limestone) is in outcrop in the Glass Mountains. These outcrop regions are shown in Figure 4.4.1.

Recharge in areas such as the Delaware Basin is typically orographically controlled with higher groundwater recharge in the areas of higher elevation where the amount of precipitation is highest and the evaporative potential is least. Beach and others (2004) provide a detailed runoff-redistribution recharge approach for the Igneous-Bolson Aquifers to the southwest of the study area. Their work established a good correlation between precipitation and elevation in the region.

Recharge in the Rustler Aquifer is probably more complex than surface infiltration. A wealth of literature provides evidence that some portion of the total Rustler Aquifer recharge, and potentially discharge, may occur through downdip cross-formational flow from other formations. As discussed in Section 4.3.4, a review of the literature indicates the following with respect to cross-formational flow into and out of the Rustler Aquifer.

- Groundwater may flow from the Rustler Aquifer into the overlying Edwards-Trinity (Plateau) Aquifer in Reeves and northwestern Pecos counties through the Diamond Y fault system, in the vicinity of the city of Belding, in northeastern Pecos County, in Culberson County, in north-central Pecos County, and in northwest Reeves County.
- Groundwater may flow from the Rustler Aquifer into the overlying Pecos Valley Aquifer in the western portion of the Pecos Valley Aquifer, in northern and western Reeves County, and in north-central Pecos County.
- Groundwater recharging the Tessey Limestone in the Glass Mountains, which is a facies equivalent to the Rustler Aquifer, flows into the Rustler Aquifer.
- Veni (1991) and Armstrong and McMillion (1961) suggest upward flow from the Capitan Reef Complex Aquifer to the overlying Rustler Aquifer.

Investigation of the Rustler Aquifer in development of this GAM has resulted in postulating recharge of the aquifer to the south from two sources. One source is the infiltration of

precipitation in the Glass Mountains through the facies equivalent Tessey Limestone. This source is consistent with that found in the literature. The other potential source is the Capitan Reef equivalent units and recharge of the Rustler Aquifer in Pecos County through cross-formational flow.

In the western Rustler Aquifer outcrop, recharge may occur as diffuse recharge in the outcrop and as focused recharge in areas where streams and draws collect storm runoff and lose water to the subsurface. Since the evaporative potential far exceeds rainfall in this region, most infiltration that occurs will be extracted through evapotranspiration in the vadose zone, netting only minimal diffuse recharge.

In the area of the Tessey Limestone, because this formation exhibits karst features in the outcrop, the amount of recharge is very hard to characterize with standard water balance (curve number) methods because a complex array of sub-basins and fractures could control the process on a very local scale. The potential for evapotranspiration is far less in this outcrop region than the western outcrop region given the higher altitude and the ability for groundwater to move away from the water table quickly.

4.4.1 Literature Estimates

There are several comprehensive studies and reviews of recharge in arid desert environments that, in concept, are relevant to the study of the Rustler Aquifer (Stone and others, 2001; Beach and others, 2004; Wilson and Guan, 2004; Berger and others, 2008; Jones, 2008). Unfortunately, there are very few studies reporting potential recharge rates for the Rustler Aquifer.

Corbet (2000) developed a regional groundwater model in Eddy County, New Mexico and Loving and Reeves counties in Texas. His model included the Dewey Lake, Dockum, and Rustler formations. He assumed a maximum regional recharge rate of 2 millimeters per year (0.09 inches per year). Gates and others (1980) used a recharge rate for the Bolson aquifers of west Texas estimated as one percent of annual precipitation.

Because of the lack of literature estimates of recharge for the Rustler Aquifer, the baseflow estimate derived in this research on the Pecos River is discussed and other discharge estimates for the Rustler Formation in the literature will be reviewed. Finally, the work of Steve Finch in Appendix B of Beach and others (2004) will be reviewed.

Final Groundwater Availability Model for the Rustler Aquifer

Boghici (1997) postulated through his research that approximately 3,800 acre-feet per year may be upwelling into the Cretaceous units overlying the Rustler Aquifer in the vicinity of the city of Belding. He also credited Diamond Y Springs with another 260 acre-feet per year from the Rustler Aquifer. In 1950, the flow at Diamond Y Springs was measured at approximately 650 gallons per minute (1,049 acre-feet per year). There exists another flowing spring/well just south of Diamond Y Springs that is unnamed. It produces enough groundwater to create a relatively large pool and a small creek flowing to the north. Assuming these flows are correct and represent the majority of flow from the Rustler Aquifer in Pecos County, then the recharge could be as high as 5,898 acre-feet per year minus losses to evapotranspiration.

Known spring discharge in the western portion of the Rustler Aquifer is isolated to a 1961 measurement at Freeport Sulphur of 200 gallons per minute (322 acre-feet per year). In southern Lea County, New Mexico, a baseflow study (see Section 4.5.1) suggests that the Pecos River gained approximately 1,107 acre feet per year (50 year record) over a subbasin area of 280 square miles, yielding a lower bound estimate of recharge in that reach of approximately 0.07 inches per year (about 0.6 percent of precipitation).

In Appendix B of Beach and others (2004), Steve Finch of Shomaker and Associates developed detailed estimates of recharge for the Igneous-Bolson Aquifers in areas bordering the Rustler Aquifer to the south. Their approach took into account climate, watershed, and geologic characteristics for each sub-basin defined in their study area. The method was quite detailed and included the following analyses: delineating mountain, alluvial fan, and Bolson sub-basins within the study area, and their hydrologic characteristics; calculating topographic statistics for each sub-basin; estimating potential recharge (corrected for elevation zones and evaporation) for each sub-basin; determining runoff from each sub-basin by analyzing the magnitude of precipitation events that result in runoff (scaled to elevation); and determining which sub-basins receive runoff from up-gradient sub-basins and the amount of runoff that is lost from the area of recharge (redistribution).

Table 4.4.1 summarizes the results from Beach and others (2004) for their study area, which includes southern portions of the Pecos Basin. Figure 4.4.2 shows the location of the basins for their work. Comparison of the amount of recharge in acre-feet per year predicted by the one percent rule (Gates and others, 1980) to the detailed analysis in Beach and others (2004) shows

these numbers are reasonably close in magnitude given the error and assumptions inherent in water balance estimates of recharge (see Beach and others, 2004).

Looking at the percent of annual recharge predicted by the detailed runoff-redistribution model of Beach and others (2004) shows that the variability in recharge expressed as a percent of annual precipitation is 0.8 to 1.9 percent with an average of 1.25 percent. The results of this comparison show that for large regional estimates of recharge, the one-percent rule is not out of step with more detailed methods.

4.4.2 Estimation of Recharge

Recharge estimates in an aquifer such as the Rustler Aquifer can be made through various means including modeling, water balance methods which might include runoff-redistribution methods as documented by Beach and others (2004), or summations of known aquifer discharge (baseflow, springflow, etc.), and geochemical and isotopic investigations. Because aquifer discharges are so poorly constrained, using forward methods to estimate a range of potential recharge is suggested. Model calibration was used to further refine this input.

In the work of Beach and others (2004), recharge rates range from 0.8 percent to 1.9 percent of annual precipitation on a basin scale. The recharge areas for the Rustler Aquifer have traditionally been considered the Rustler Hills in Culberson County and the Tessey Limestone in the Glass Mountains. In the following discussion, Capitan Reef carbonates in southern Pecos County and northeastern Brewster County are also included because this unit is in direct contact with the Tessey Limestone outcrop and could conceivably have the potential for cross-formational flow moving into the subsurface.

Table 4.4.2 provides the three potential outcrop areas that could be providing recharge from infiltration of precipitation to the Rustler Aquifer. Again, there is no direct evidence to suggest that the Capitan Reef in southern Pecos County is contributing recharge to the Rustler. If it did, it would have to be cross-formational flow as groundwater moved from higher elevations in the south (Glass Mountains) to lower elevations to the north. Table 4.4.2 provides the outcrop areas in square miles, the annual average precipitation expressed in inches per year, and the total precipitation expressed in acre-feet per year.

Table 4.4.3 used the annual average precipitation for each of the potential recharge areas described above and a range of assumed recharge factors expressed as a percent of annual precipitation to look at potential recharge volumes for the recharge areas. For the Rustler Aquifer outcrop area (Rustler Hills in Texas to New Mexico), a reasonable range to explore is 0.77 to 2 percent of annual precipitation, similar to the results from Beach and others (2004). For the Tessey Limestone outcrop and by extension the Capitan Reef in the Glass Mountains, recharge rates could be much higher than 2 percent of annual precipitation because these formations may behave as karsts, with decreasing runoff, increasing infiltration, and fast movement into the subsurface. In addition, it would be expected that the water table would be relatively deep at higher elevations minimizing direct evapotranspiration from groundwater. A recharge factor of up to 10 percent of annual precipitation is considered for these two potential recharge areas. From the suggested ranges, it is apparent that recharge to the Brewster and Pecos county outcrops is poorly constrained. Because significant quantities of groundwater can be produced in near downdip portions of the aquifer, some recharge must occur to offset production and natural discharge.

4.4.3 Rejected Recharge

Rejected recharge is the concept that some water that reaches the water table as recharge in the unconfined part of the aquifer does not travel significant distances downdip into the confined part of the aquifer. It discharges instead as springs or evapotranspiration and/or into streams and rivers. For the Rustler Aquifer, a great majority of infiltration that reaches the water table in the western outcrop belt (Rustler Hills) is expected to be rejected through the processes of evapotranspiration and perched springs. A discussion of springs in the western outcrop belt is provided in Section 4.5.2. Potential groundwater evapotranspiration as a sink is discussed in Section 4.7.1. It is believed that there is far less potential for evapotranspiration as a sink for the Tessey Limestone outcrop due to deeper water tables, and thus less potential for rejected recharge.

Table 4.4.1 Summary of recharge estimates in Beach and others (2004).

Characteristic	Units	Salt Basin	Pecos Basin	Rio Grande	Total
Total annual average precipitation	acre-feet per year	2,111,077	1,512,759	1,798,709	5,422,545
Total annual average precipitation	inches per year	15.8	15.8	15.6	
One-percent rule⁽¹⁾	acre-feet per year	21,111	15,128	17,987	54,255
Runoff-redistribution	acre-feet per year	23,389	28,741	13,810	67,940
Runoff-redistribution	percent of annual precipitation	1.20 percent	1.90 percent	0.77 percent	1.25 percent

(1) after Gates and others (1980).

Table 4.4.2 Characteristics of potential Rustler Aquifer recharge areas.

Outcrop	Area (square miles)	Average Precipitation (inches per year)	Total Precipitation (acre-feet per year)
Rustler Aquifer outcrop	496.4	13.1	347,875
Tessey Limestone	29.3	16.5	25,776
Capitan Reef	132.2	16.5	116,320

Table 4.4.3 Potential recharge as a percent of annual average precipitation for a range of assumed recharge factors expressed as a percent of annual precipitation.

Outcrop	Potential Recharge as a Percent of Annual Average Precipitation (acre-feet per year)			
	0.77 percent	1 percent	2 percent	10 percent
Rustler Aquifer outcrop	2,679	3,479	6,958	NA
Tessey Limestone	198	258	516	2,578
Capitan Reef	896	1,163	2,326	11,632

Final Groundwater Availability Model for the Rustler Aquifer

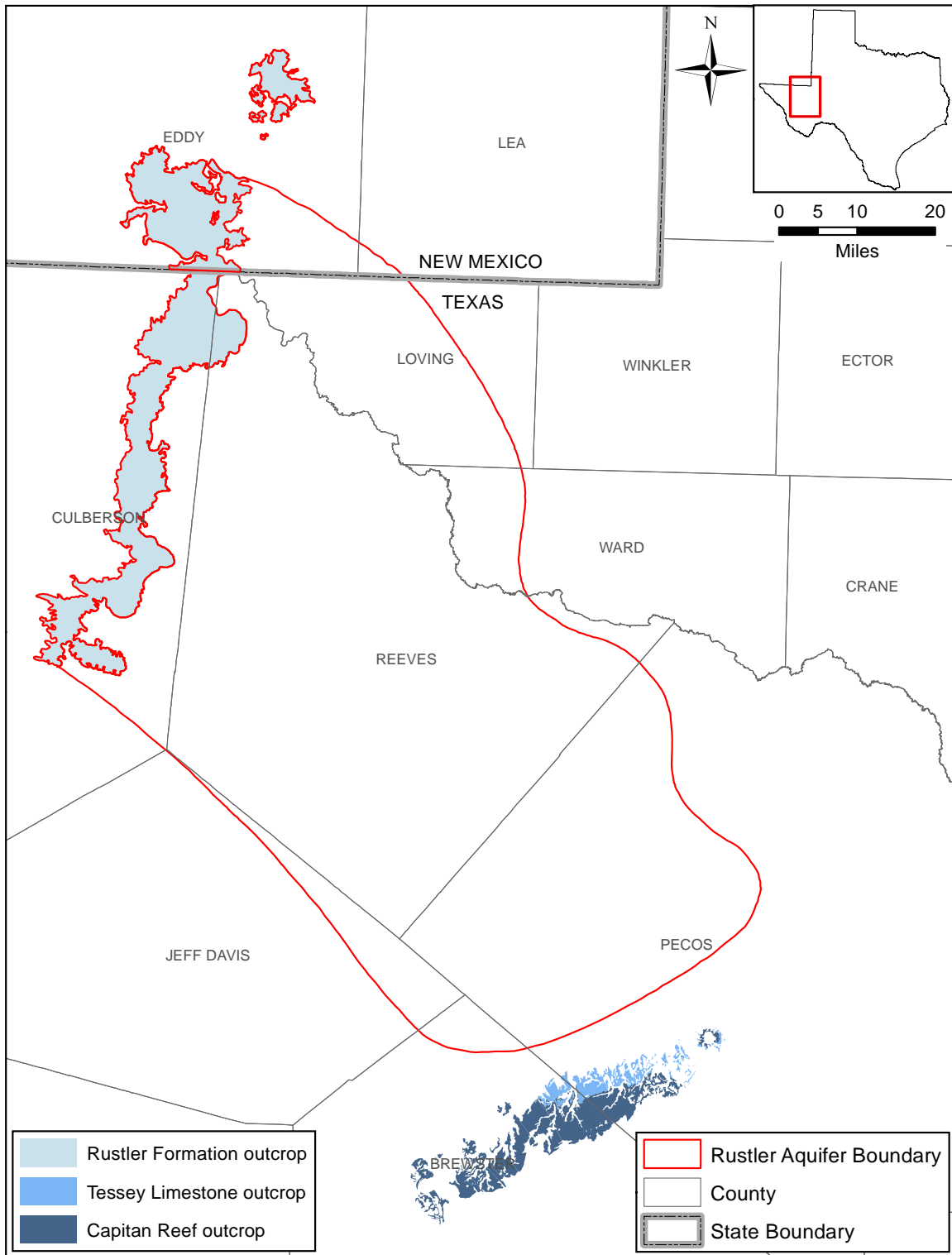

Figure 4.4.1 Rustler Aquifer outcrop regions (United States Geological Survey – Texas Water Science Center and the Texas Natural Resource Information Center, 2004; George and others, 2011).

Final Groundwater Availability Model for the Rustler Aquifer

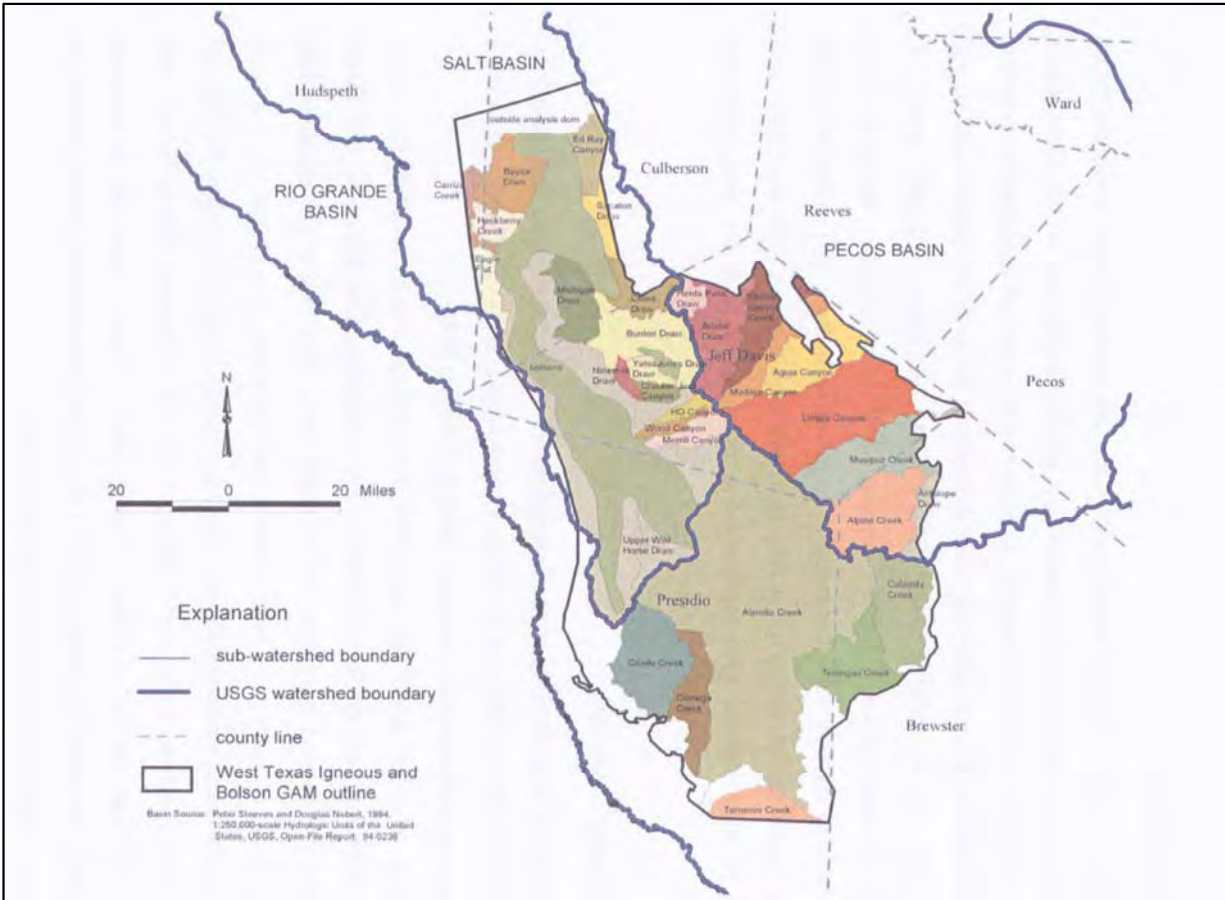

Figure 4.4.2 Basin and sub-basins in the Beach and others (2004) study area (from Beach and other, 2004).

This page intentionally left blank.

4.5 Rivers, Streams, Springs, and Lakes

The interaction between groundwater and surface water can occur at the locations of rivers, streams, springs, and lakes. Interaction occurs primarily where the surface water body intersects an aquifer outcrop. Rivers and streams can either lose water to the underlying aquifer, resulting in aquifer recharge, or gain water from the underlying aquifer, resulting in aquifer discharge. Discharge from an aquifer also occurs where the water table intersects the ground surface at spring or seeps. For the Rustler Aquifer, discharge via a spring also occurs where the hydraulic head in the aquifer is sufficient to drive water to the surface through cracks and fractures. Lakes, like rivers and streams, may provide a potential site of focused recharge when the water table is below the elevation of the lake, or may gain water from the aquifer when the water table is above the elevation of the lake.

4.5.1 Rivers and Streams

In locations where rivers and streams intersect aquifer outcrops, interaction between groundwater and surface water can occur. Depending on the elevation of the water table, groundwater can either enter the stream from the aquifer or leave the stream and contribute to the aquifer. For a losing stream, the water table is below the elevation of the stream stage, and the gradient causes water to flow from the stream to the aquifer. For a gaining stream, the water table is above the elevation of the stream stage, causing water to flow from the aquifer to the stream.

In this section, the interaction between groundwater and streams is investigated in the Rustler Aquifer outcrop, and the average stream gain/loss that occurs is estimated. Baseflow was analyzed for two gages on the Pecos River that intersect the Rustler Aquifer outcrop, and gain/losses were estimated based on the difference in baseflow.

Background

One major river, the Pecos River, and many smaller streams intersect the Rustler Aquifer outcrop (Figure 4.5.1). Data from two United States Geological Survey gages, 08407000 and 08407500, located on the Pecos River were used to determine gain/losses (United States Geological Survey, 2010b). The location of these gages is also shown on Figure 4.5.1 along with exceedence curves for the gages. The exceedence curves were created using daily mean streamflow data for the

period of January 1, 1952 through July 15, 2010 for gage 08407000 and the period of October 1, 1937 through December 6, 2010 for gage 08407500. The exceedence curves indicate that the river flows continuously at these locations (i.e., there is a very low probability of zero flow at these gages).

Existing Studies

No existing studies were found to describe river gain/loss in the Rustler Aquifer outcrop. The unproductive search of existing studies included a review of gain/loss studies in Texas completed by Slade and others (2002).

Estimating Gain/Loss through Hydrograph Separation

Hydrograph separation is a method by which direct surface runoff and baseflow is partitioned and quantified. For the current analysis, the hydrograph separation code Base Flow Index (Wahl and Wahl, 1995) was utilized in order to determine the baseflow for multiple years of data. An example of this separation can be seen in Figure 4.5.2 for gage 08047500.

Although running the Base Flow Index code is fairly straightforward, choosing appropriate gage data is essential for producing reliable results. Several criteria must be satisfied to ensure that the analysis is accurate. The criteria used in this study are listed below:

- the gage should be on a stream that is considered to be primarily gaining,
- the catchment area of the gage should be primarily in the outcrop,
- if the contributing area is outside of the outcrop, then an upstream gage must be utilized in order to subtract the effects of the upstream area, and
- the majority of the contributing area must be unregulated.

The first criterion ensures that the baseflow separation calculation is viable. For a river with perennial flow, much of the basin yield usually comes from baseflow, indicating that some portion of the rainfall is infiltrated into the basin and reaches the stream as subsurface flow (Chow and others, 1988). However, if the gage is located on an intermittent stream, the stream

may not be consistently gaining, and any estimates of baseflow made during times when the stream is flowing would not be representative of a long term average gaining condition. The second and third criteria ensure that gains/losses are calculated for the aquifer being analyzed and the fourth criteria ensures that gains to the system are due to groundwater rather than a false signal due to continual, steady discharge from reservoirs.

The results of the basis flow analysis are presented in Figure 4.5.3. The average calculated gain along this reach of the Pecos River is 1,107 acre-feet per year, and the river distance between gages is approximately 14.1 miles, with a differential contributing area of about 280 square miles. The resulting average gain per river mile is 78.5 acre-feet per year per mile, or about 0.74 inches per year, in terms of flux to the contributing subwatershed. In order to determine the annual gain/loss, annual baseflow from the upstream gage was subtracted from the annual baseflow from the downstream gage. The results from this calculation are presented in Table 4.5.1. Only the years where both gages had full streamflow records (1952 to 2009) were used in the calculation of yearly gain/loss. This calculation indicates that the Pecos River had extended periods of loss from 1953 to 1955 and 1968 to 1971 and extended periods of gain from 1956 to 1958, 1972 to 1976, 1979 to 1987, 1989 to 1992, 1994 to 1996, 1999 to 2002, and 2007 to 2009. The overall average yearly gain/loss for the period from 1952 to 2009 was calculated as 1,107 acre-feet per year.

4.5.2 Springs

Springs are locations where the water table intersects the ground surface. In addition, for the Rustler Aquifer, springs are found outside of the outcrop at locations where the aquifer is connected to the surface through structural features, such as cracks or fractures, and the pressure in the aquifer is sufficient to drive groundwater to the surface through those features. Three sources were used to find spring data for the Rustler Aquifer: the TWDB groundwater database (TWDB, 2010c), a database of Texas springs compiled by the United States Geological Survey and reported in Heitmuller and Reece (2003), and a report on the springs of Texas by Brune (2002). All Rustler Aquifer springs found in the TWDB groundwater database were also found in Heitmuller and Reece (2003). Three of the eight Rustler Aquifer springs reported in Brune (2002) were found in the TWDB groundwater database and Heitmuller and Reece (2003).

The TWDB groundwater database and Heitmuller and Reece (2003) provide coordinates for springs but Brune (2002) does not include coordinates for springs. The locations of the Rustler Aquifer springs given in Brune (2002) were estimated in this study. First, an attempt was made to match the spring in Brune (2002) with a spring in the TWDB groundwater database. For three springs, the name of the spring given in Brune (2002) matches the name of a spring given in the TWDB groundwater database. For five other springs reported in Brune (2002), no match could be found in the TWDB groundwater database or Heitmuller and Reece (2003). For those five springs, an approximate location was determined by scanning a hard copy of the spring location map provided by Brune (2002), georeferencing the scanned map in ArcGIS using the intersection of county boundaries, and digitizing the spring location. These digitized locations are considered to be approximate because the county boundaries on the Brune (2002) map are somewhat different from those in the TWDB county shapefile.

Figure 4.5.4 shows the locations of springs discharging from the Rustler Aquifer or from both the aquifer and the Castile Formation. Four of those springs are located in the portion of the Rustler Aquifer outcrop located in Texas and four of the springs are located in the downdip portion of the aquifer. All of the springs shown on this map are reported as discharging from the Rustler Aquifer except for the spring in Pecos County. Although that spring, Diamond Y Springs, is reported in the TWDB groundwater database, Heitmuller and Reece (2003), and Brune (2002) as discharging from the Edwards-Trinity (Plateau) Formation, Boghici (1997) provides water-chemistry data that indicates that the Rustler Aquifer is the source of water at that spring. In addition to chemistry data, spring discharge data also support the assumption that Diamond Y Springs discharges from the Rustler Aquifer. Two other springs, Comanche and Leon springs, are located in the same vicinity as Diamond Y Springs. Discharge from both Comanche and Leon springs stopped when the potentiometric surface of the Edwards-Trinity (Plateau) Aquifer was lowered due to groundwater development in the Fort Stockton area. Although discharge to Diamond Y Springs has historically declined, the spring continues to flow. This suggests that the Edwards-Trinity (Plateau) Aquifer is the source of water for Comanche and Leon springs but not for Diamond Y Springs. Based on this evidence, and the chemistry investigation conducted by Boghici (1997), the source of water to Diamond Y Springs is considered in this study to be the Rustler Aquifer. This conclusion is in agreement with Sharp

and others (2003) who indicate that the source of the brackish water discharging at Diamond Y Springs is the Rustler Formation.

Table 4.5.2 provides a summary of discharge from the Rustler Aquifer springs. A flow rate is not available for several of the springs and only one flow rate is available for several others. More than two measurements of spring discharge are available only for Diamond Y Springs. A plot of discharge to that spring is provided in Figure 4.5.5.

4.5.3 Lakes and Reservoirs

Typically, interaction between an aquifer and a lake or reservoir is restricted to the outcrop area of an aquifer where the lake or reservoir lies directly on the aquifer. There are no natural lakes or reservoirs in the outcrop of the Rustler Aquifer. However, there is thought to be interaction between the Rustler Aquifer and Red Bluff Reservoir, which is located on the Pecos River slightly downdip of the Rustler Aquifer outcrop (Figure 4.5.6). Brune (2002) indicates that many small unnamed, moderately saline springs discharge from the Rustler Aquifer into Red Bluff Reservoir in a collapse zone. In addition, the presence of a layer of higher saline water at the base of the reservoir suggests discharge from the Rustler Aquifer into the reservoir (Powers, 2010). In addition, Richey and others (1985) indicate that the water level began to rise in a pumping well 8-days into an aquifer test of the Rustler Formation north of the reservoir. They concluded that the rising water levels were the result of the cone of depression intercepting Red Bluff Reservoir and the Pecos River creating recharge to the formation. They also state that the water level in wells located near the reservoir rise and fall with the rise and fall of the lake level. These data suggest that Red Bluff Reservoir and the Rustler Aquifer are hydraulically connected.

The controlling authority for Red Bluff Reservoir, which was impounded in 1937 and has a surface area of 11,193 acres, is the Red Bluff Water Power Control District (Texas Parks and Wildlife, 2010). Daily lake elevations for Red Bluff Reservoir from January 1, 1970 through October 31, 2010 were obtained from the controlling authority (Red Bluff Water Power Control District, 2010). Average monthly lake elevations, calculated from the daily values, indicate variations ranging from about 2,785 to 2,840 feet above mean sea level (Figure 4.5.6).

Final Groundwater Availability Model for the Rustler Aquifer

Table 4.5.1 Annual gain/loss between selected gages from 1952 to 2009.

Year	08407000 Baseflow (acre-feet)	08407500 Baseflow (acre-feet)	Gain/Loss (acre-feet)
1952	32,774	33,004	230
1953	26,447	25,397	-1,050
1954	18,815	18,760	-55
1955	31,259	29,513	-1,746
1956	36,575	37,823	1,248
1957	21,811	22,098	287
1958	33,446	38,384	4,938
1959	55,862	53,959	-1,903
1960	30,597	32,327	1,730
1961	49,811	51,829	2,018
1962	27,950	27,167	-783
1963	22,463	22,525	62
1964	13,455	13,537	82
1965	5,986	5,305	-681
1966	14,928	16,774	1,846
1967	17,127	18,273	1,146
1968	17,006	16,239	-767
1969	17,090	14,950	-2,140
1970	24,473	24,133	-340
1971	15,080	14,646	-434
1972	10,872	10,989	117
1973	26,338	27,398	1,060
1974	17,324	17,648	324
1975	47,307	49,910	2,603
1976	18,160	18,547	387
1977	10,907	10,750	-157
1978	4,924	4,343	-581
1979	25,099	25,539	440
1980	25,289	25,911	622
1981	30,895	32,378	1,483
1982	19,717	21,236	1,519
1983	20,011	22,265	2,254
1984	21,817	23,071	1,254
1985	35,393	37,614	2,221
1986	36,735	39,151	2,416
1987	140,789	152,574	11,785
1988	51,427	50,903	-524
1989	35,450	35,575	125
1990	23,099	23,144	45
1991	24,740	27,349	2,609
1992	78,995	80,918	1,923
1993	45,484	44,445	-1,039
1994	38,423	38,856	433
1995	48,811	49,711	900
1996	40,941	41,880	939
1997	44,651	42,690	-1,961
1998	66,630	62,265	-4,365
1999	44,208	45,472	1,264
2000	32,611	35,142	2,531
2001	32,074	37,673	5,599
2002	21,221	21,974	753
2003	19,216	16,895	-2,321
2004	19,416	21,210	1,794
2005	60,230	66,295	6,065
2006	64,819	63,436	-1,383
2007	37,752	42,129	4,377
2008	27,812	36,717	8,905
2009	23,970	30,095	6,125
1952 to 2009 average			1,107

Final Groundwater Availability Model for the Rustler Aquifer

Table 4.5.2 Summary of spring flows from the Rustler Aquifer.

County	Spring Name (State Number/Brune Number)	Formation	Elevation (ft)	Max flow (lps)	Max flow (gpm)	Max flow (cfs)	Max flow (AFY)	Date of Max	Min flow (lps)	Min flow (gpm)	Min flow (cfs)	Min flow (AFY)	Date of Min	Number of Measure- ments	Source
Culberson	Hurd Spring (4747703/25)	Rustler	3802											0	TWDB/USGS/ Brune
Culberson	Rustler Spring (4723701/13)	Rustler	3493	12.6	200	0.45	323	1/1/1961	1	16	0.04	26	Apr-76	2	TWDB/USGS/ Brune
Culberson	Horseshoe Springs (na/21)	Rustler		1.7	27	0.06	44	Apr-76						1	Brune
Culberson	Maverick Springs (na/19)	probably Rustler												0	Brune
Culberson	Screwbean Springs (na/12)	Rustler & Castile		20	317	0.71	512	Apr-76						1	Brune
Culberson	Virginia Springs (na/20)	Rustler & Castile		7	111	0.25	179	Apr-76						1	Brune
Pecos	Diamond Y Springs (4557801/33)	Rustler ^(a)	2790	41.0	650	1.45	1049	7/19/1950	11.6	184	0.41	297	1/1/1992	5	TWDB/USGS/ Brune
Reeves	springs (na/35)	Rustler		0.68	11	0.02	17	5/8/1978						1	Brune

^(a) indicated as an Edwards-Trinity (Plateau) Aquifer spring in the sources but assumed to be dominantly a Rustler Aquifer spring based on a chemical investigation conducted by Boghici (1997), historical discharge, and Sharp and others (2003)

na = not applicable

TWDB = TWDB groundwater database

USGS = Heitmuller and Reece (2003)

Brune = Brune (2002)

Final Groundwater Availability Model for the Rustler Aquifer

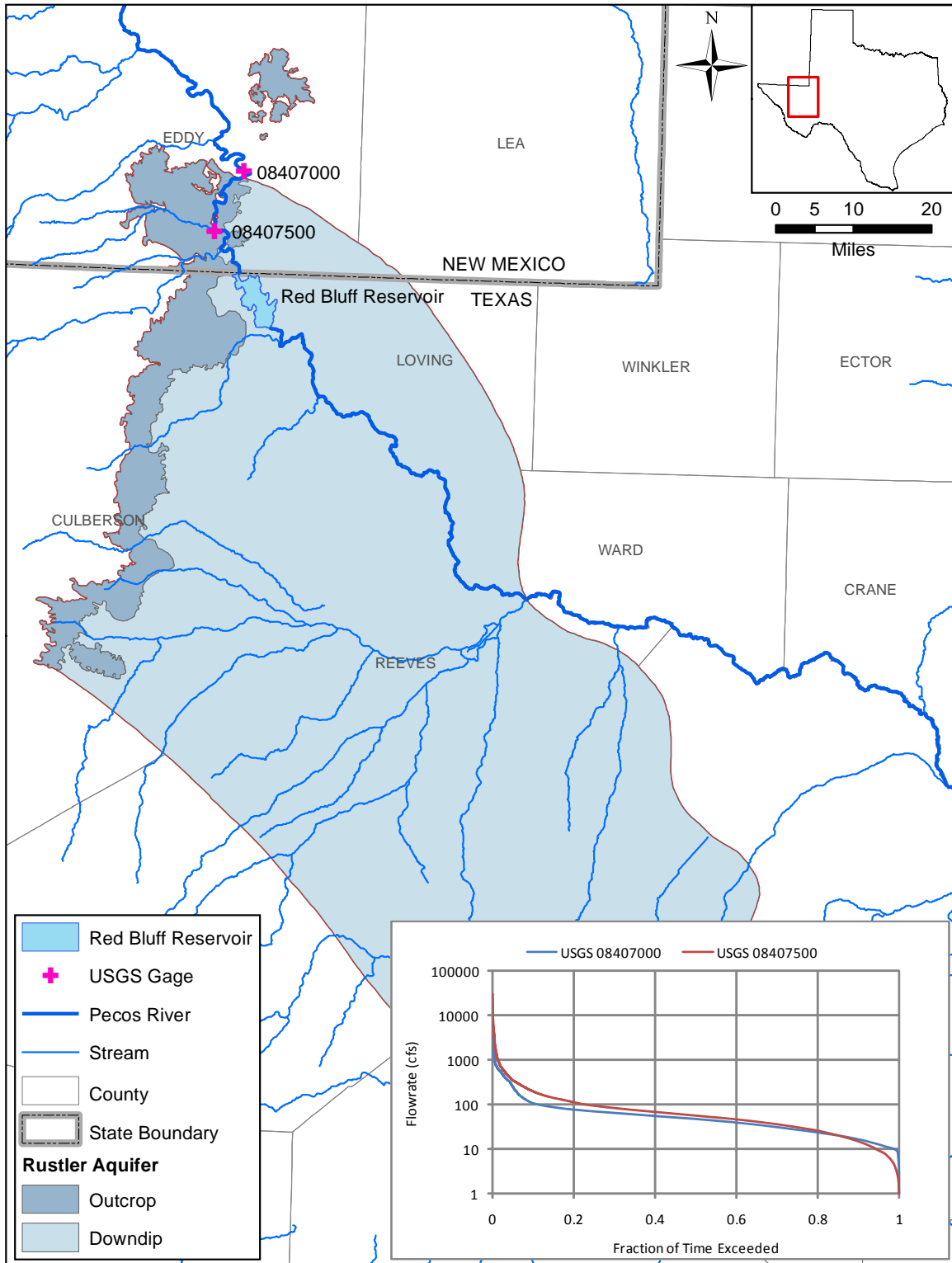

Figure 4.5.1 Location and flow duration curves (in cubic feet per second) for selected stream gages in the Rustler Aquifer outcrop (United States Geological Survey, 2010b).

Final Groundwater Availability Model for the Rustler Aquifer

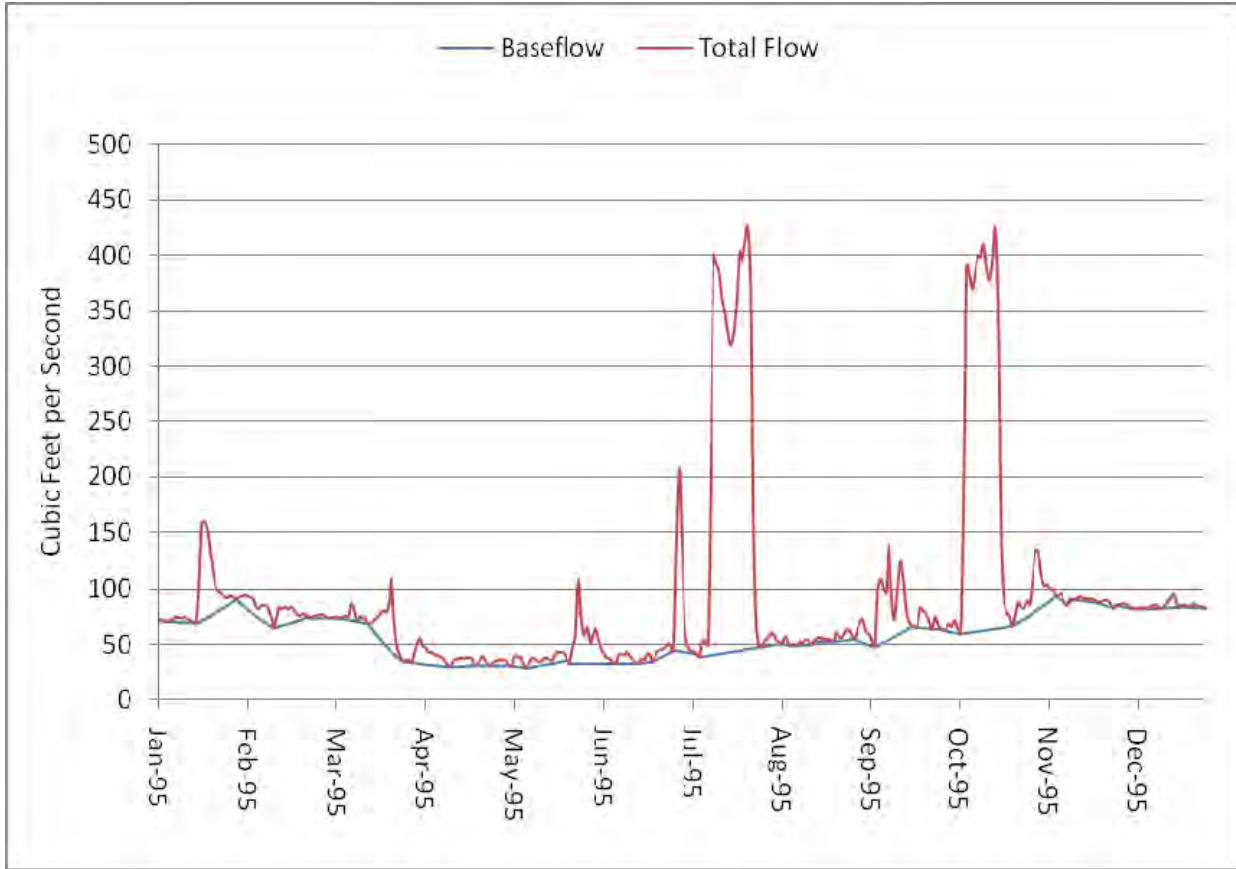

Figure 4.5.2 Example baseflow separation for United States Geological Survey gage 08407500 (United States Geological Survey, 2010b).

Final Groundwater Availability Model for the Rustler Aquifer

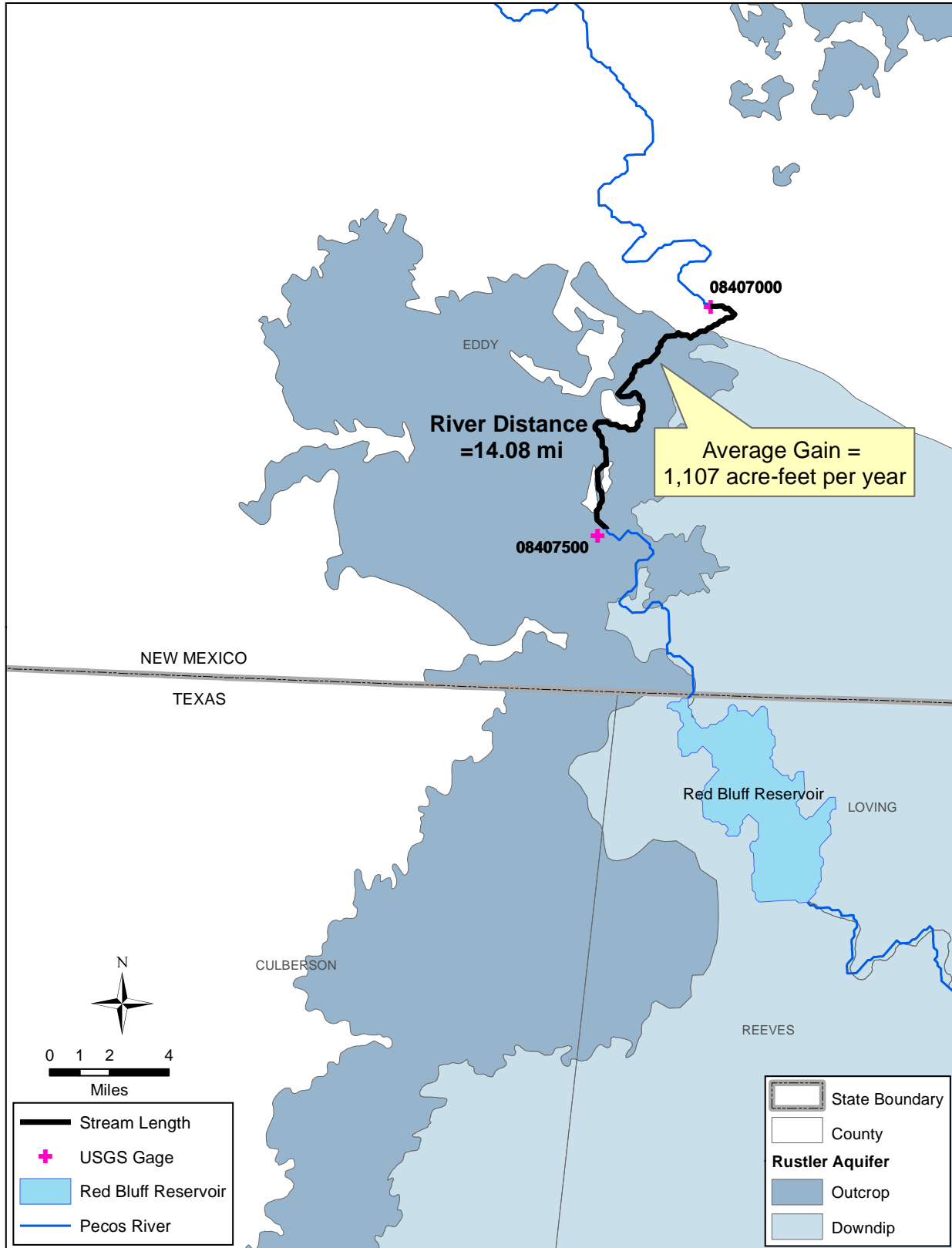

Figure 4.5.3 Calculated gain based on hydrograph separation analysis (United States Geological Survey, 2010b).

Final Groundwater Availability Model for the Rustler Aquifer

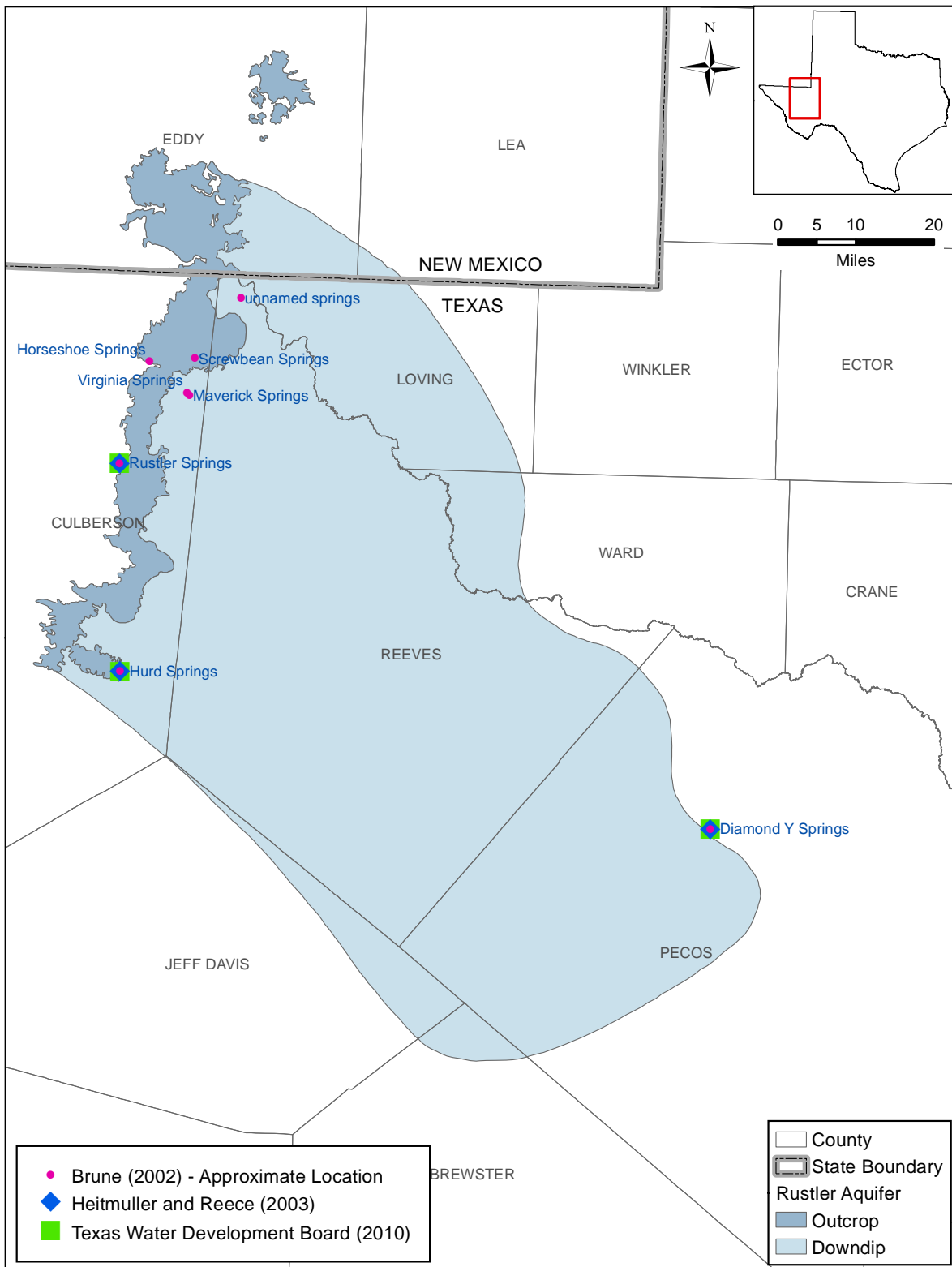

Figure 4.5.4 Locations of springs flowing from the Rustler Aquifer (Brune, 2002; Heitmuller and Reece, 2003; TWDB, 2010c).

Final Groundwater Availability Model for the Rustler Aquifer

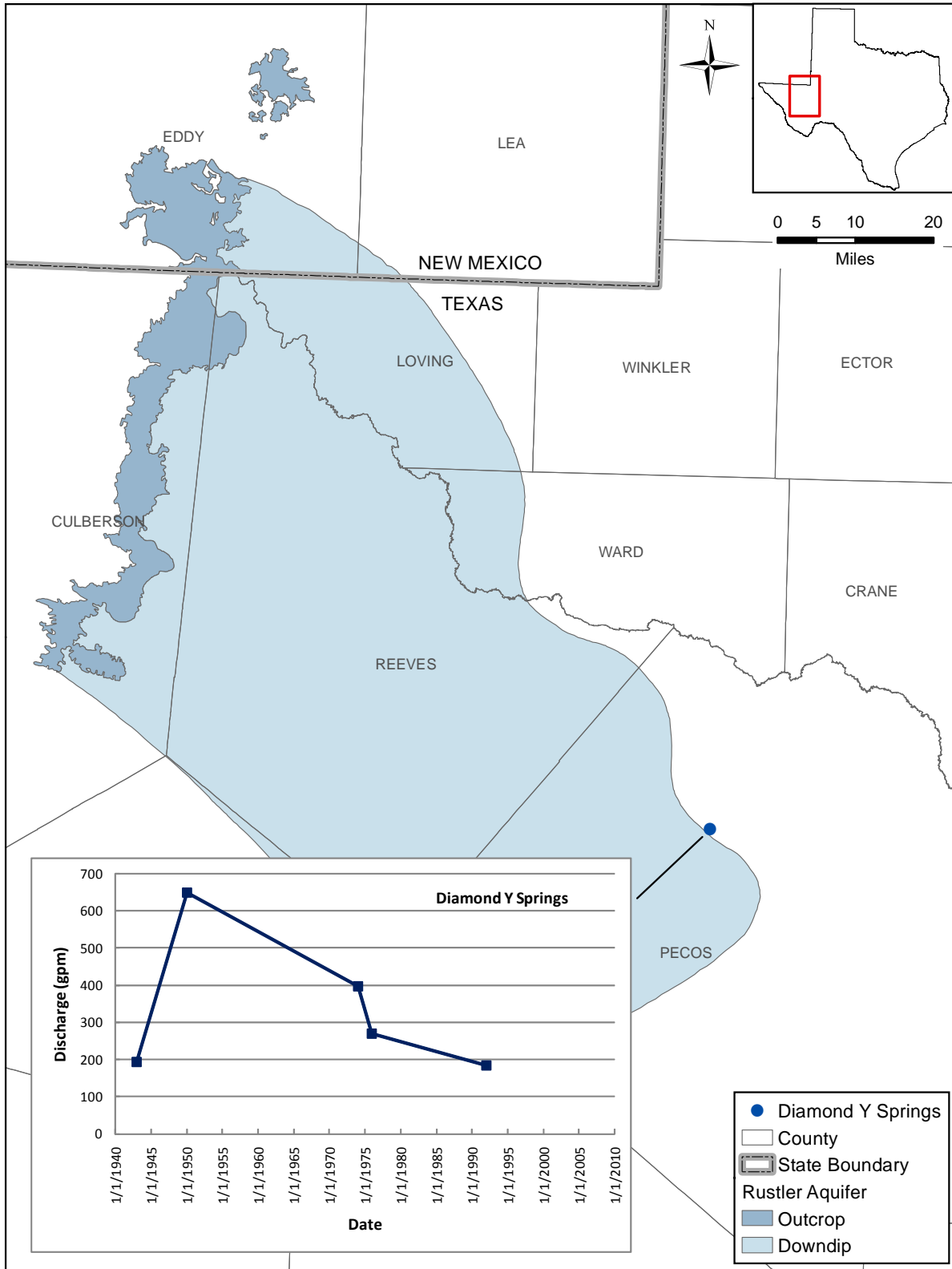

Figure 4.5.5 Hydrograph of discharge (in gallons per minute) from Diamond Y Springs (Brune, 2001; Heitmuller and Reece, 2003; TWDB, 2010c).

Final Groundwater Availability Model for the Rustler Aquifer

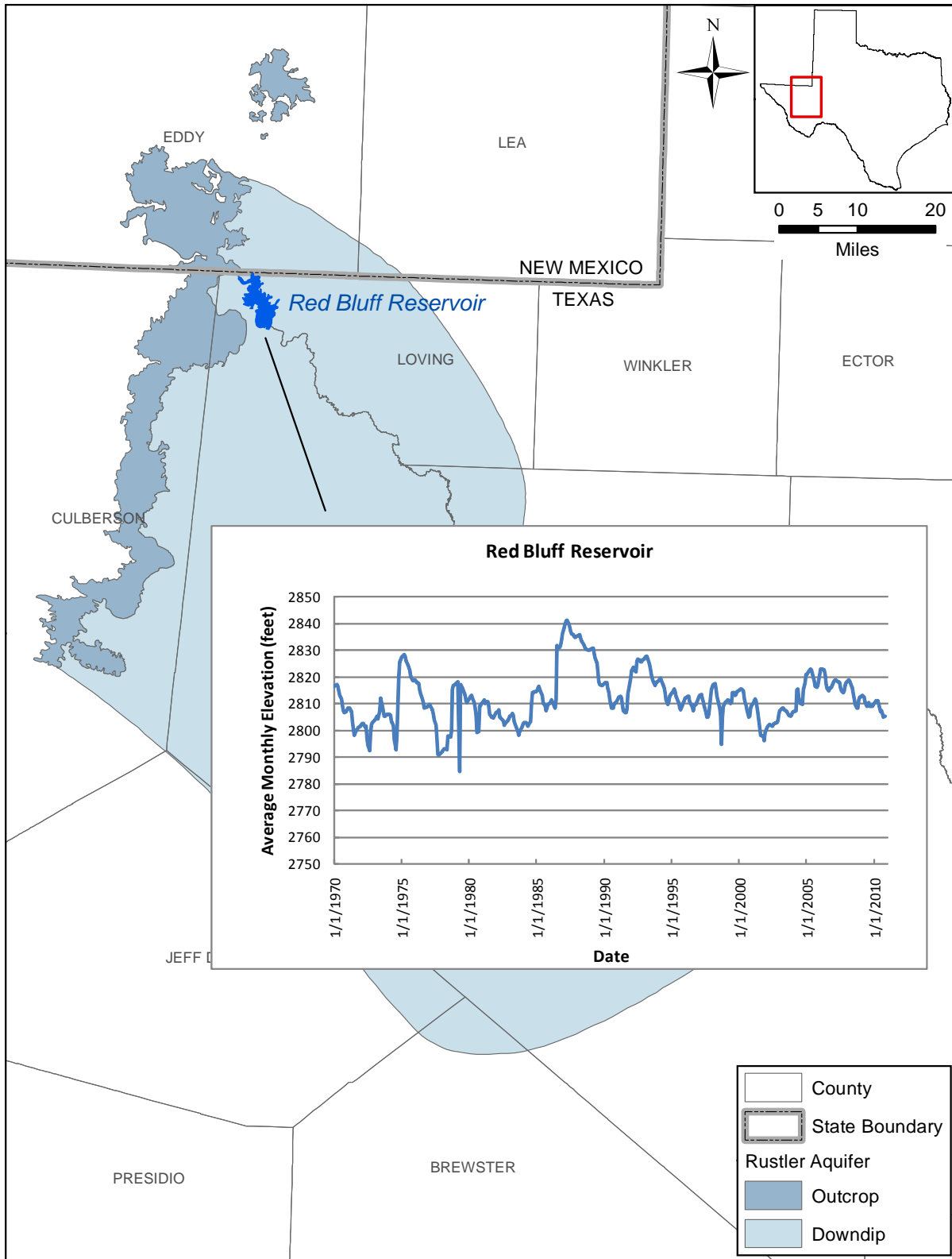

Figure 4.5.6 Hydrograph of average monthly elevation for Red Bluff Reservoir (Red Bluff Water Power Control District, 2010).

This page intentionally left blank.

4.6 Hydraulic Properties

Little is known regarding the hydraulic properties of the Rustler Formation in Texas. The ability of the aquifer to transmit groundwater to a well varies greatly. Factors impacting the ability of the aquifer to transmit groundwater include: aquifer lithology (especially the presence of halite), dissolution of salt below the aquifer, structural deformation, fracturing, and thickness of overburden. This section reviews the sources of available data describing Rustler Aquifer hydraulic properties and integrates that data such that it can be used for implementation into the groundwater model. Because conceptual models of Rustler Aquifer hydraulic properties are generally lacking in Texas, this section uses the detailed conceptual model for the Culebra Dolomite Member of the Rustler Formation in the vicinity of the Waste Isolation Pilot Plant (WIPP) site (Holt and others, 2005; Powers and others, 2003, 2006) as a surrogate for processes important to Rustler Formation properties in Texas. Soft information used to inform the conceptual model of hydraulic properties for the Rustler Formation include the structural subdomain information introduced in Section 4.2.

Several hydraulic properties are used to describe groundwater flow in aquifers. The properties discussed here are hydraulic conductivity, transmissivity, coefficient of storage or storativity, and specific capacity. Each of these terms is briefly described below.

Hydraulic Conductivity - The measure of the ease with which groundwater can flow through an aquifer. Higher hydraulic conductivity indicates that the aquifer will allow more water movement under the same hydraulic gradient. Units for hydraulic conductivity may be expressed in feet per day or gallons per day per square foot.

Transmissivity - This term is closely related to hydraulic conductivity and refers to the product of the hydraulic conductivity times the effective aquifer thickness. Transmissivity describes the ability of groundwater to flow through the entire thickness of an aquifer. As the thickness of the aquifer increases, the transmissivity increases for a given hydraulic conductivity. Units for transmissivity may be expressed in square feet per day or gallons per day per foot.

Storativity - Also referred to as the coefficient of storage, this term describes the volume of water a confined aquifer will release when the water level in an aquifer is lowered. Storativity is a dimensionless parameter.

Specific Capacity - This parameter reflects the efficiency of a well and an aquifer to produce water to the well. Specific capacity is dependent on both the properties of the aquifer as well as the efficiency of the well. Specific capacity is expressed in terms of gallons per minute per foot of drawdown in the well.

4.6.1 Data Sources

Development of hydraulic properties for the Rustler Aquifer in Texas used multiple sources including: Richey and others (1985); Myers (1969); Cooper and Glanzman (1971); specific capacity data from drillers' logs on the Texas Water Development Board (TWDB) website (TWDB, 2010d); various reports on the WIPP site characterization program, and transmissivity and storativity data from the WIPP site (Beauheim, 2011a, 2011b). Typically, specific capacity values were not reported in the drillers' logs but, rather, were calculated from reported well yield and drawdown.

A search of the Texas Commission on Environmental Quality (TCEQ) well records was conducted in an effort to obtain specific capacity data for wells completed into the Rustler Aquifer. The TCEQ well location grid was overlain on the general boundaries of the Rustler Aquifer. For the majority of wells contained in the TCEQ records, locations are identified only at the TCEQ grid-block level, which is a 2.5-minute by 2.5-minute area. The TCEQ well records do not include the aquifer in which the wells are completed. Therefore, the depth of the screened interval, or the total well depth when screen data were not available, was compared to the top and bottom depths of the Rustler Aquifer to determine whether wells are completed into the aquifer. No Rustler Aquifer wells were identified during this search.

The best hydraulic property data for the Rustler Formation are from the detailed characterization program related to the WIPP site. At the WIPP site, detailed characterization, including transmissivity and storativity, are available for the Culebra Dolomite Member of the formation which, at the WIPP site (southern Eddy County, New Mexico), represents the most transmissive member of the Rustler Formation. These WIPP site data provide 62 point estimates of

transmissivity and 36 estimates of storage coefficient determined from interference tests. The WIPP site transmissivity and storativity data are discussed in Sections 4.6.3 and 4.6.6, respectively.

Richey and others (1985) report an interference test performed along the Pecos River just north of Red Bluff Reservoir in Eddy County, New Mexico that yielded a range in transmissivity from 52,377 to 237,754 square feet per day in the Culebra Dolomite Member of the formation. This is the only test reported to be performed in the outcrop portion of the aquifer. Cooper and Glanzman (1971) performed tests at the Project Gnome Site in Eddy County, New Mexico and measured an average Culebra Dolomite Member transmissivity of 568 square feet per day.

Little is known regarding the hydraulic properties of the Rustler Formation in Texas and most of it is semi-quantitative information such as reports of well productivity. Reported well yields in the Rustler Aquifer vary from almost no production to an ability to pump up to 4,400 gallons per minute (Boghici and Van Broekhoven, 2001). There are many flowing wells within the Rustler Aquifer (see Figure 4.3.3) and this is particularly true in Pecos County where some of the highest well productivity has been documented (TWDB, 2010d). Permit applications submitted to the Middle Pecos Groundwater Conservation District for two wells completed into the Rustler Aquifer near the city of Belding indicate estimated withdrawal rates of 2,690 and 3,100 gallons per minute (Middle Pecos Groundwater Conservation District, 2009).

In certain areas of the aquifer, acidizing greatly improved well yields and in some cases eliminated dry holes (Ogilbee and others, 1962; Rees and Buckner, 1980; Boghici, 1997). Acidizing Rustler Formation wells became common in 1955. It is believed that acidizing wells was a common practice in the Central Basin Platform where Rustler Formation groundwater was used to support oil and gas activities.

The locations of hydraulic property data for the Rustler Formation in Texas are illustrated in Figure 4.6.1. Unfortunately, there are very little data for this aquifer in Texas. Using all sources available, eight estimates of specific capacity, two estimates of transmissivity, and no estimates of storativity were found for the Rustler Formation in Texas. Note that two of the specific capacity values are for the same well.

4.6.2 Calculation of Hydraulic Conductivity from Specific Capacity

Because specific capacity is relatively easy to measure, requiring knowledge of only the pumping rate and drawdown, it is commonly reported in well records. However, hydraulic conductivity is a more useful parameter than specific capacity for regional groundwater modeling. The following methodology was used to estimate transmissivity from specific capacity data.

Point estimates of aquifer transmissivity can be made based on measurements of specific capacity, typically recorded by the driller during the initial installation of a well. Ideally, a representative set of coincident pump test/specific capacity data are available to allow for a customized relationship to be established through regression (e.g., Mace, 2000). However, in the absence of pump test data, transmissivity can still be estimated using the Cooper-Jacob solution for drawdown in a pumping well (Cooper and Jacob, 1946):

$$s = \frac{Q}{4\pi T} \ln\left(\frac{2.25Tt}{r^2 S}\right) \quad (4.6.1)$$

where

- s = drawdown in the well [L],
- Q = pumping rate [L^3/T],
- T = transmissivity [L^2/T],
- t = time [T],
- r = radius of the well [L], and
- S = storativity [--]

Equation (4.6.1) can be rearranged to solve for specific capacity as:

$$\frac{Q}{s} = \frac{4\pi T}{\ln\left(\frac{2.25Tt}{r^2 S}\right)} \quad (4.6.2)$$

For a given specific capacity, transmissivity can be solved for iteratively. Table 4.6.1 provides available and calculated specific capacity and transmissivity data for Rustler Formation wells in Texas.

Hydraulic conductivity was calculated as the transmissivity divided by the screen length or the length of the Rustler Formation interval in the borehole. For three wells, the interval length was unknown so the isopach of Rustler Formation thickness developed for this project (Figure 4.3.5) was used to estimate the formation thickness. The calculated estimates of hydraulic conductivity are also provided in Table 4.6.1. These hydraulic conductivity values could be biased low if the Rustler Formation interval does not contribute equally to well production.

4.6.3 Waste Isolation Pilot Plant Site Conceptual Model for Rustler Formation Transmissivity

Studies on the Rustler Formation, and particularly the Culebra Dolomite Member, have been performed since the early 1960s in the area of southeastern Eddy County, New Mexico. While some early studies were related to the Project Gnome Site, the vast majority of these studies have been performed to support the Department of Energy's WIPP site. Because of the paucity of hydraulic data available within the Texas portion of the Rustler Aquifer, available hydraulic properties and the controls on those properties determined from characterization studies for the WIPP site are briefly described here. The purpose of this discussion is to use some of the lessons learned regarding the relationship between formation characteristics and transmissivity to provide calibration guidance for the model study area for the Rustler Aquifer in general.

The WIPP site relies on detailed characterization of the Culebra Dolomite Member of the Rustler Formation because it is locally the most transmissive member of the formation and of any hydrogeologic unit above the host rock (Salado Formation). In general, areas of high transmissivity around the WIPP site are characterized as being fractured portions of the Culebra Dolomite Member. In the WIPP site region, the transmissivity of the Culebra Dolomite Member varies over six orders of magnitude. This large variability has been demonstrated to be the result of post-depositional processes rather than depositional processes (Holt and others, 2005). Predicting transmissivity with such wide variability and distinct trends is problematic without a conceptual understanding of the processes controlling this variability.

Researchers at the WIPP site (Holt and Powers, 1984, 1986, 1988, 1990a; Holt and others, 2005) have developed a detailed conceptual model for describing transmissivity within the Culebra Dolomite Member in the area of the WIPP site. It is assumed that the more recent results from geohydrological studies at the WIPP site are applicable, at least in part, for providing a better

understanding of the range of hydraulic parameters to be assigned in a general hydrologic model of the Rustler Aquifer in Texas. Hydraulic properties of the Culebra Dolomite Member are strongly correlated with geologic factors of regional significance, and these geologic factors are strong estimators of formation transmissivity. While the Culebra Dolomite Member is only a small part of the Rustler Formation, it is hydraulically the most significant part over a large region, and the factors affecting this member likely affect other parts of the Rustler Formation similarly. In the absence of significant data on the hydraulic properties over much of the model domain, these factors provide surrogate information to conceptually constrain the modeling efforts. The principal sources of this information are Holt (1997), Powers and others (2003, 2006), and Holt and others (2005). These factors are applied in current performance assessment for the WIPP site.

Three main geological factors account for most of the variability of Culebra Dolomite Member hydraulic properties: depth, dissolution of the upper Salado Formation, and the distribution of halite in the Rustler Formation. Depth (overburden thickness) affects fracture aperture and granular porosity, with transmissivity decreasing with increasing depth. The dissolution of the upper Salado Formation halite created strain on the overlying Rustler Formation, which has been observed to add approximately 1.6 orders of magnitude to the transmissivity of the Culebra Dolomite Member in the vicinity of the WIPP site. Significant halite in members bounding the Culebra Dolomite Member has also been shown to correlate to reduced transmissivity of the Culebra Dolomite Member (Powers and others, 2003, 2006; Holt and others, 2005). In addition to a very low transmissivity in these regions, the groundwater is very saline and is pressurized above hydrostatic pressures even considering the effects of the brine. Similar observations have been made for the Rustler Formation and upper Salado Formation in Andrews County, Texas (Pickens and others, 2008).

There is no doubt that geological conditions already investigated at and around the WIPP site may not apply to all areas of the Rustler Aquifer domain. Nevertheless, the geological factors related to hydraulic properties can guide the range of parameters used in modeling. Depth is the easiest to evaluate, given the large number of logs that have been used to develop elevation maps of the top of the Rustler Formation as well as the base of the Rustler Formation (top of Salado Formation). With topographic data readily available, the two sources can be combined to

develop a reasonable estimation of the depth of the formation (i.e., overburden thickness) at nearly any point. The data for evaluating upper Salado Formation dissolution are not directly available for this study. Through WIPP site and related studies in Andrews County, Texas, Holt and Powers (2010) provide further evidence of the processes controlling dissolution in the Salado Formation and the relationship to physical features at the surface. The disruption of topography and of Rustler Formation elevation is used here as an estimator of areas where upper Salado Formation dissolution may be a contributing factor in the hydraulic character of the Rustler Formation. Because Rustler Formation halite has such an impact on formation hydraulic properties, additional data on the distribution of halite in the formation was acquired to set a general bound on this factor.

Figure 4.6.2 plots the transmissivity data available from the WIPP site characterization program (Beauheim, 2011a) with the transmissivity log transformed as a function of depth of the unit below ground surface. Three populations can be seen on Figure 4.6.2. The first is a high transmissivity data set (red circles) that reflects wells where upper Salado Formation dissolution has been documented. The blue triangle data set shows wells where upper Salado Formation dissolution has not occurred and these wells yield transmissivities that are not reflective of a fractured medium. The green squares data set show wells with intermediate transmissivity thought to be controlled by the proximity of halite. For each transmissivity distribution, there is a general trend of decreasing transmissivity with depth (thickness of overburden).

Assuming an average thickness of approximately 24.3 feet for the Culebra Dolomite Member (Meigs and others, 2000), the hydraulic conductivity for these data were calculated and are plotted on Figure 4.6.3. The high hydraulic conductivity data indicative of fractures have equivalent hydraulic conductivities of 1.5 to 61 feet per day. The hydraulic conductivity for the lowest unfractured data set varies from 0.0015 to 0.08 feet per day.

Figure 4.6.4 plots the Rustler Aquifer hydraulic conductivity values in Texas along with the estimates determined from the WIPP site program. All of the Texas values plot in the high transmissivity field representing some combination of dissolution and structural deformation. Like most property data sets developed from the available literature, they also tend to be reflective of good wells and, thus, be biased high. However, since the Rustler Formation is an

aquifer in Texas and not an aquifer in New Mexico, productivity is expected to be better in Texas, especially given the presence of significant outcrop, large regional structural deformation, and the presence of mountains to the south (potential recharge source).

4.6.4 Spatial Conceptual Model for Transmissivity of the Rustler Formation

In the analysis of geophysical logs performed in support of developing the Rustler Formation structure, an attempt was made to discern information related to the known regional factors that experience at the WIPP site have shown to be important in predicting hydraulic properties for the formation. These include the evidence for dissolution in the underlying Salado Formation and evidence of halite within the Rustler Formation. Because of the variable quality of the geophysical logs and the limited regional nature of this study, information regarding halite presence and in some regards dissolution is considered first order and very regional. The third regional factor, depth of overburden, is a direct product of development of the Rustler Formation structure. Figure 4.6.5 plots the depth to the top of the Rustler Formation (or the overburden thickness) in the study area.

The method proposed for spatially distributing the transmissivity of the Rustler Formation combines the lessons from the regional conceptual model for transmissivity developed at the WIPP site with the structural subdomains described in Section 4.2. Table 4.6.2 summarizes the factors assumed to be controlling the transmissivity of the Rustler Formation in the study area on a subdomain basis. The structural subdomains found in Figure 4.2.10 were revised to a small degree in this discussion based upon hydrologic data reviewed to date to develop the hydrostructural domains plotted in Figure 4.6.6. Changes between the structural domains in Figure 4.2.10 and the hydrostructural domains in Figure 4.6.6 include the division of structural subdomain 4 into two zones, 4A and 4B, and the division of structural subdomain 7 into two zones, 7A and 7B. An explanation of these hydrostructural subdomains is provided below.

Hydrostructural subdomains 1, 3 and 6 are in portions of the study area where significant halite is present within the Rustler Formation, minimal dissolution of the upper Salado Formation has occurred, and the measured transmissivities are very low and below typical magnitudes for aquifers. These three hydrostructural subdomains are outside of the active model domain for the Rustler Aquifer groundwater availability model (GAM).

Hydrostructural subdomain 10 is the Rustler Aquifer outcrop in eastern Culberson County, Texas and Eddy County, New Mexico. In this area, the dissolution of the Salado Formation has been complete and in some areas extending to the underlying Castile Formation. Dissolution also occurs in the Rustler Formation as discussed in Section 4.2. There would be no halite present in subdomain 10 and the consideration of overburden and depth of burial is not of concern. Hydraulic properties are expected to be sufficient to allow production from wells and several wells are present within the Rustler Aquifer outcrop area in Texas. The transmissivity is expected to be highly variable and karstic features could exist in the outcrop region.

Immediately downdip and hydraulically downgradient from subdomain 10 is subdomain 8. This subdomain represents an area where upper Salado Formation (and/or Castile Formation) dissolution has occurred and there is no halite observed in the Rustler Formation. In addition, because this subdomain is subsurface, the depth of burial is a factor in property definition. The Rustler Formation in this subdomain is expected to have transmissivities supporting an aquifer, but that diminish with depth.

Subdomain 9 is defined by faulting in the Rustler Formation along the northeastern and eastern boundaries and probably the southern boundary. The western boundary is somewhat arbitrary and coincides with a depth to top of Rustler Formation of between 400 and 500 feet. This subdomain approximately coincides with a subbasin in Reeves and northwestern Pecos counties. The faulting to the east is believed to have been the product of Salado Formation dissolution, although this factor is poorly assessed in this area. There is no halite in the Rustler Formation and the depth of overburden is assumed to play a key role in lowering transmissivities in this area.

Subdomains 7A and 7B represent a portion of the Rustler Formation where there is little evidence for extensive Salado Formation dissolution and there is little halite in the Rustler Formation. This area has had much less structural deformation than areas to the east and west and still maintains the regional eastward dip in the structure. This subdomain has been arbitrarily subdivided into subdomains 7A and 7B at the Pecos River. The reason for this subdivision is that subdomain 7A is known to be relatively tight in southern New Mexico and probably eastern Loving County, Texas. However, in Reeves County there are several

groundwater wells producing from the Rustler Aquifer. Some of these wells originally flowed. Both Hentz and others (1989) and Richey and others (1985) report a basal sandstone in the Rustler Formation in Reeves County. Eager (1984) also reports that the Rustler in this area has more carbonate facies, which could have better transmissivity.

Subdomain 4 represents the large graben structure within the Rustler Formation that roughly overlies the Capitan Reef Complex Aquifer. There has been significant structural deformation and the Rustler Formation is very deep in most of this subdomain. In many areas, it is likely cut off from the rest of the Rustler Formation and overlying formations and is juxtaposed against the Salado Formation or some residual of the Salado/Castile formations. Obviously, halite dissolution of the underlying formations is important to hydraulic properties in this subdomain, and depth of overburden may be as well. Halite is not expected to be in the Rustler Formation. This subdomain has been subdivided into 4A and 4B in the vicinity of Fort Stockton based upon hydrological considerations. There are no wells within subdomain 4A and the depth of the formation is almost entirely between 1,500 and 2,500 feet. In the area of Fort Stockton in subdomain 4B, the top of the Rustler Formation is shallower and there are many wells (most of them originally flowing) and Diamond Y Springs (still flowing) indicating a transmissive aquifer with hydraulic drive.

Subdomain 5 represents the outcrop of the Tessey Limestone, which is commonly believed to be an equivalent facies to the Rustler Formation and is also believed to be the source of recharge to the formation in Pecos County. The Tessey Limestone has been studied by Hill (1996) who documented karstic features in the Tessey Limestone outcrop indicative of high transmissivity. Subdomains 4B and 5 are considered to be the highest transmissivity areas of the aquifer.

Subdomain 2 is east of the Rustler Formation graben and is likely not connected to the Rustler Aquifer as defined by the TWDB. Measured transmissivities in this subdomain are relatively high, but they may be a product of acidizing the formation.

Because limited transmissivity information are available in the Texas portion of the aquifer, the hydrostructural subdomains were relied upon to guide model parameterization and calibration. The information regarding measured transmissivities, the indication of secondary porosity (Salado Formation dissolution), and the presence of halite in the Rustler Formation were used to

guide initial transmissivity ranges. A depth trend on properties taken from the WIPP site data was used. The relative transmissivity and aquifer potential of the hydrostructural subdomains are provided in Figure 4.6.7. While this range of transmissivities is somewhat speculative, it is to the extent possible based upon observed data and the conceptual understanding of the Rustler Formation.

4.6.5 Vertical Hydraulic Conductivity

Data for the vertical hydraulic conductivity in the Rustler Aquifer were not found during the literature review. In areas where the aquifer is thought to be largely structurally intact, the vertical hydraulic conductivity would be limited by the hydraulic conductivity of the lower permeability units such as anhydrites and mudstones. Beauheim (1987) reported that hydraulic testing of the claystones at the WIPP site yielded a transmissivity range of 7.1×10^{-2} square feet per day to as low as 1.0×10^{-5} square feet per day or less. This equates to a range of hydraulic conductivity of less than approximately 1 foot per day to as low as 3.0×10^{-4} feet per day. The highest value was measured in an area of the Rustler Formation that has seen significant post-depositional deformation enhancing permeability. Beauheim (1987) reported that hydraulic testing of anhydrites at the WIPP site within the Rustler Formation using surface based packer testing proved unsuccessful because transmissivities were so low that they could not be measured.

In areas of the Rustler Formation where significant structural deformation has not occurred, horizontal to vertical anisotropy ratios up to a factor of 10,000 are expected. In areas where significant dissolution and structural deformation has occurred, anisotropy in hydraulic conductivity is expected to approach unity. It is generally accepted that groundwater models provide the best means for estimating vertical hydraulic conductivity at a regional scale (Anderson and Woessner, 1992) and this was required for the Rustler Aquifer GAM.

4.6.6 Storativity

The specific storage of a confined saturated aquifer is defined as the volume of water a unit volume of aquifer releases from storage under a unit decline in hydraulic head (Freeze and Cherry, 1979). The storativity is equal to the product of specific storage and aquifer thickness and is dimensionless. For unconfined conditions, the storativity is referred to as the specific

yield and is defined as the volume of water an unconfined aquifer releases from storage per unit surface area of aquifer per unit decline in water table (Freeze and Cherry, 1979). Aquifer storage properties are directly related to aquifer porosity in the unconfined portions of an aquifer and porosity and aquifer matrix compressibility in the confined portions of the aquifer.

A literature review was conducted for storativity of the Rustler Aquifer and estimates were only found for aquifer tests performed in New Mexico and generally related to either the WIPP site characterization program or the Project Gnome Site characterization study, both located in Eddy County. Richey and others (1985) report an interference test performed along the Pecos River just north of Red Bluff Reservoir, also in Eddy County, New Mexico, that yielded a range in storage coefficients of 0.01 to 0.21 with an average value of 0.1. This is within the outcrop of the Rustler Formation. Cooper and Glanzman (1971) performed tests at the Project Gnome Site in Eddy County, New Mexico and measured storage coefficients that averaged 2×10^{-5} .

The best storage estimates available for the Rustler Formation come from detailed interference tests performed in the Culebra Dolomite Member associated with the 30-year characterization program at the WIPP site. These tests are generally performed on hydropads where multiple wells are completed into the formation within several hundred feet of each other. Table 4.6.3 lists the average storage coefficients and storativity numbers from tests at several hydropad locations based in data from Beauheim (2011b). The storage parameter for each hydropad represents an average for several tests between multiple wells and analyzed for drawdown and recovery where possible. The specific storage has been estimated assuming an average Culebra Dolomite Member thickness of 24.5 feet in the vicinity of the WIPP site. The range in average storage coefficients is from 1×10^{-5} to 5.7×10^{-4} . These values represent low storage coefficients representative of aquifers that are deeply confined and can possess secondary porosity.

Final Groundwater Availability Model for the Rustler Aquifer

Table 4.6.1 Rustler Formation specific capacity and transmissivity data in Texas.

Well Number	County	Specific Capacity (gpm/ft)	Transmissivity (gpd/ft) ⁽¹⁾	Transmissivity (ft ² /d)	Hydraulic Conductivity (ft/d)	Rustler Thickness (ft)	Reference/ Source	Comments
4517802	Winkler	15.85	35,301.8	4,720	47.2	100	well log (TWDB, 2010d)	average from two tests
4534703	Ward	8.65	18,637.9	2,492	155.7	16	well log (TWDB, 2010d)	
4640702	Ward	1.70	3,585.0	479	1.2	400 ⁽²⁾	well log (TWDB, 2010d)	
4640703	Ward	2.40	4,800.5	642	1.6	405 ⁽²⁾	well log (TWDB, 2010d)	
5216609	Pecos	400.00	1,046,497.0	139,906	544.4	257	well log (TWDB, 2010d)	
4542802	Ward	26.00	59,478.7	7,952	568.0	14	well log (TWDB, 2010d)	
4525317	Ward	4.70	22,000	2,941	13.4	220 ⁽¹⁾	Myers (1969)	after testing the Rustler Formation the well was plugged back to the alluvium

⁽¹⁾reported value for well 4525317 in Ward County; and other values calculated using equation 4.6.2 for all others.

⁽²⁾thickness and depth of interval based upon the Rustler Formation isopach developed in this report.

gpm/ft = gallons per minute per foot

gpd/ft = gallons per day per foot

ft²/d = square feet per day

ft/d = feet per day

ft = feet

Final Groundwater Availability Model for the Rustler Aquifer

Table 4.6.2 Summary of controls on transmissivity and observed transmissivity ranges for hydrostructural subdomains.

Subdomain	Dissolution	Rustler Halite	Overburden	Transmissivity Range (square feet per day)	Comments
1	None	Yes	Applicable	Nonreported	Very tight and outside active model domain
2	Rare	Unknown	Applicable	2,941 to 7,952	Some productivity in Ward County, acidized?
3	Yes	Likely	Applicable	Nonreported	Very tight and outside active model domain
4a	Yes	None	Applicable	Nonreported	Very deep, thick Dewey Lake Formation, likely isolated
4b	Yes	None	Applicable	139,906	Very productive area, flowing wells and springs from Rustler Formation
5	Not Applicable	Not Applicable	Applicable	Nonreported	Tessey Limestone outcrop, karstic limestone
6	None	Yes	Applicable	0.04 to 1.9	Very tight and outside active model domain
7a	None	None	Applicable	4.4 to 1,474	May have to impose a decreasing trend west to east and to south
7b	Likely	None	Applicable	Nonreported	Higher transmissivity due to increase dolomite and basal sand stone
8	Yes	None	Applicable	Nonreported	Thin to absent Dewey Lake Formation
9	Yes	None	Applicable	Nonreported	Western edge has upper Salado Formation dissolution - other unknown
10	Yes	None	Not Applicable	Nonreported	Rustler Formation outcrop, karst features in places

Table 4.6.3 Summary of literature estimates of storage for the Culebra Dolomite Member of the Rustler Formation.

County	WIPP Hydropad	Number of Measurements	Storage Coefficient	Specific Storage (1/ft)	Reference
Eddy, NM	H-2	2	1.5×10^{-5}	6.11×10^{-7}	Beauheim and Ruskauff (1998)
Eddy, NM	H-3	6	5.70×10^{-5}	2.32×10^{-6}	Beauheim (2002)
Eddy, NM	H-6	10	1.82×10^{-4}	7.42×10^{-6}	Beauheim and Ruskauff (1998)
Eddy, NM	H-9	12	5.71×10^{-4}	2.33×10^{-5}	Beauheim and Ruskauff (1998)
Eddy, NM	H-11	3	5.23×10^{-5}	2.13×10^{-6}	Beauheim and Ruskauff (1998)
Eddy, NM	H-19	3	4.27×10^{-5}	1.74×10^{-6}	Beauheim and Ruskauff (1998)

NM = New Mexico
ft = feet

Final Groundwater Availability Model for the Rustler Aquifer

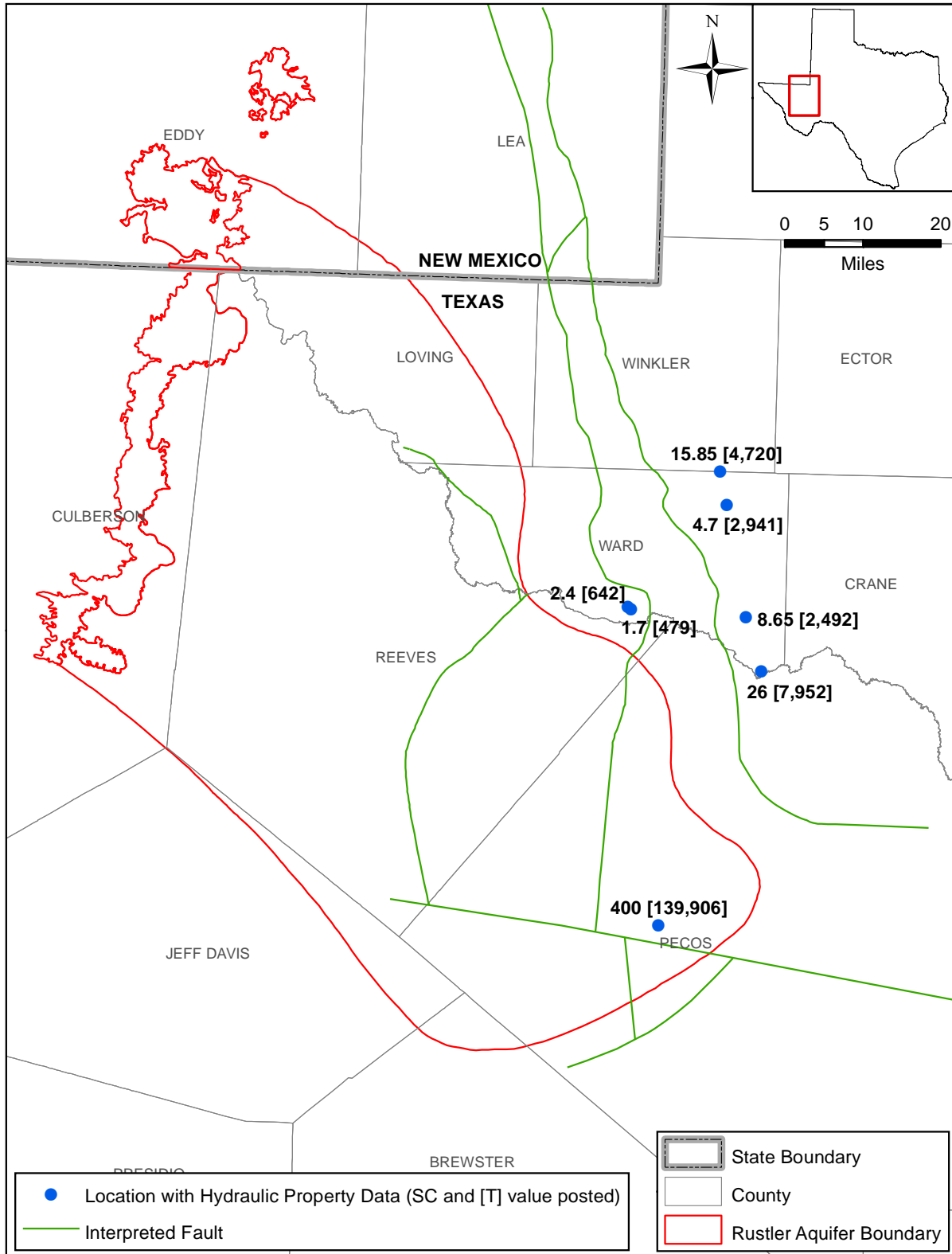

Figure 4.6.1 Available hydraulic property data for the Rustler Formation in Texas (Myers, 1969; TWDB, 2010d). Posted values are specific capacity (in gallons per minute per foot) following by transmissivity in brackets (in square feet per day).

Final Groundwater Availability Model for the Rustler Aquifer

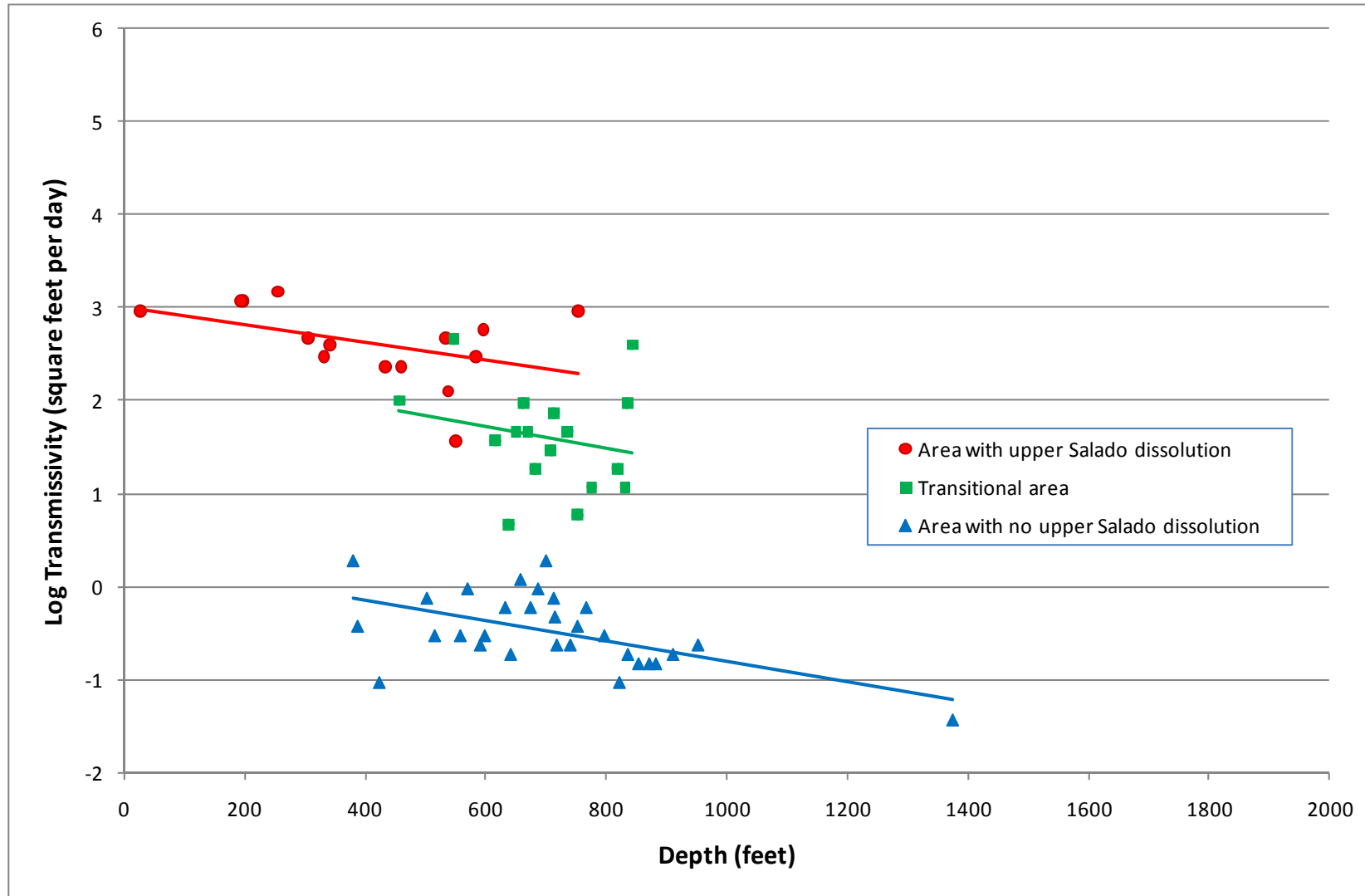

Figure 4.6.2 Measured transmissivity data from the Culebra Dolomite Member of the Rustler Formation in Eddy County, New Mexico (Beauheim, 2011a).

Final Groundwater Availability Model for the Rustler Aquifer

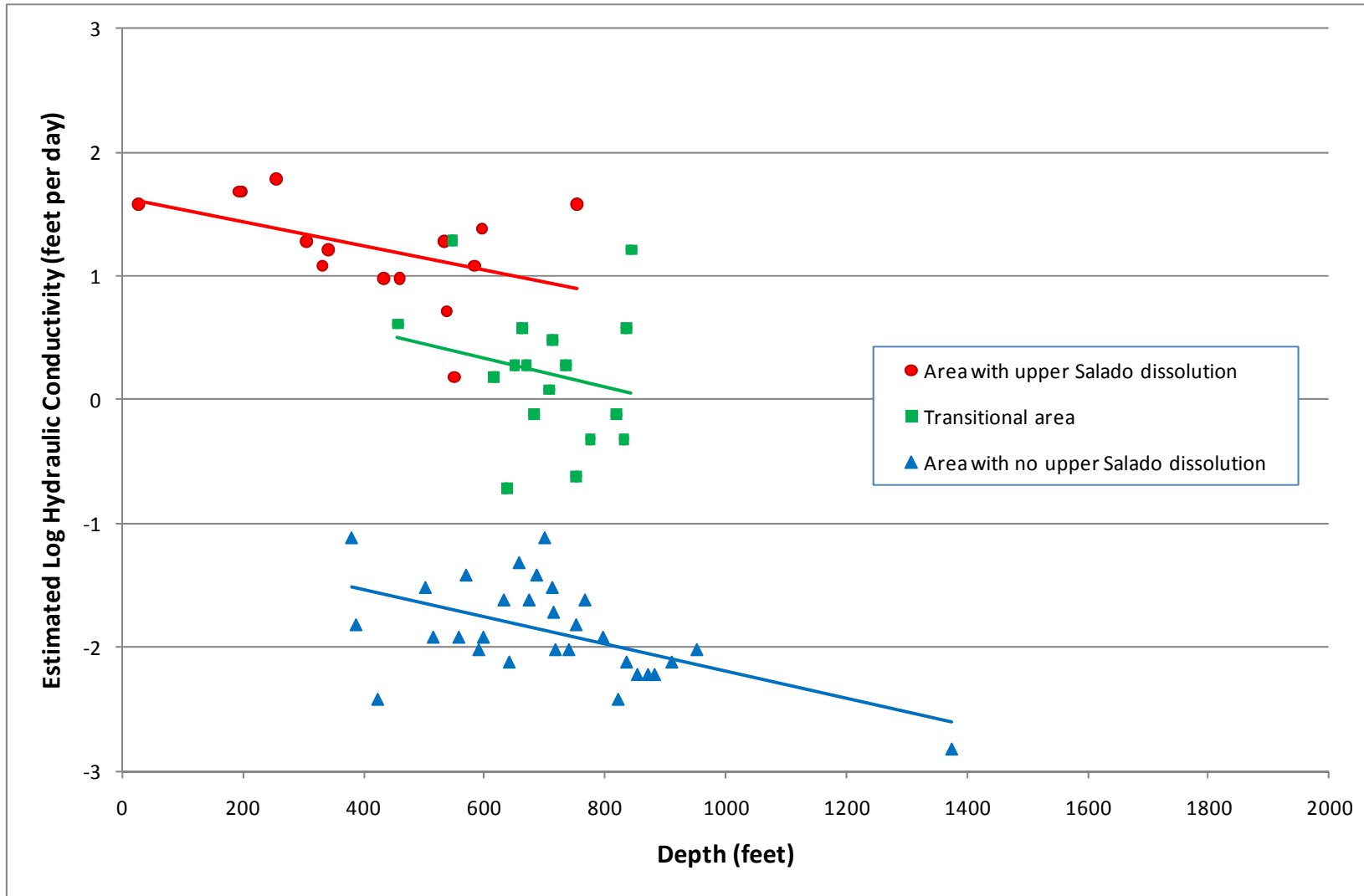

Figure 4.6.3 Estimated hydraulic conductivity of the Culebra Dolomite Member of the Rustler Formation in Eddy County, New Mexico.

Final Groundwater Availability Model for the Rustler Aquifer

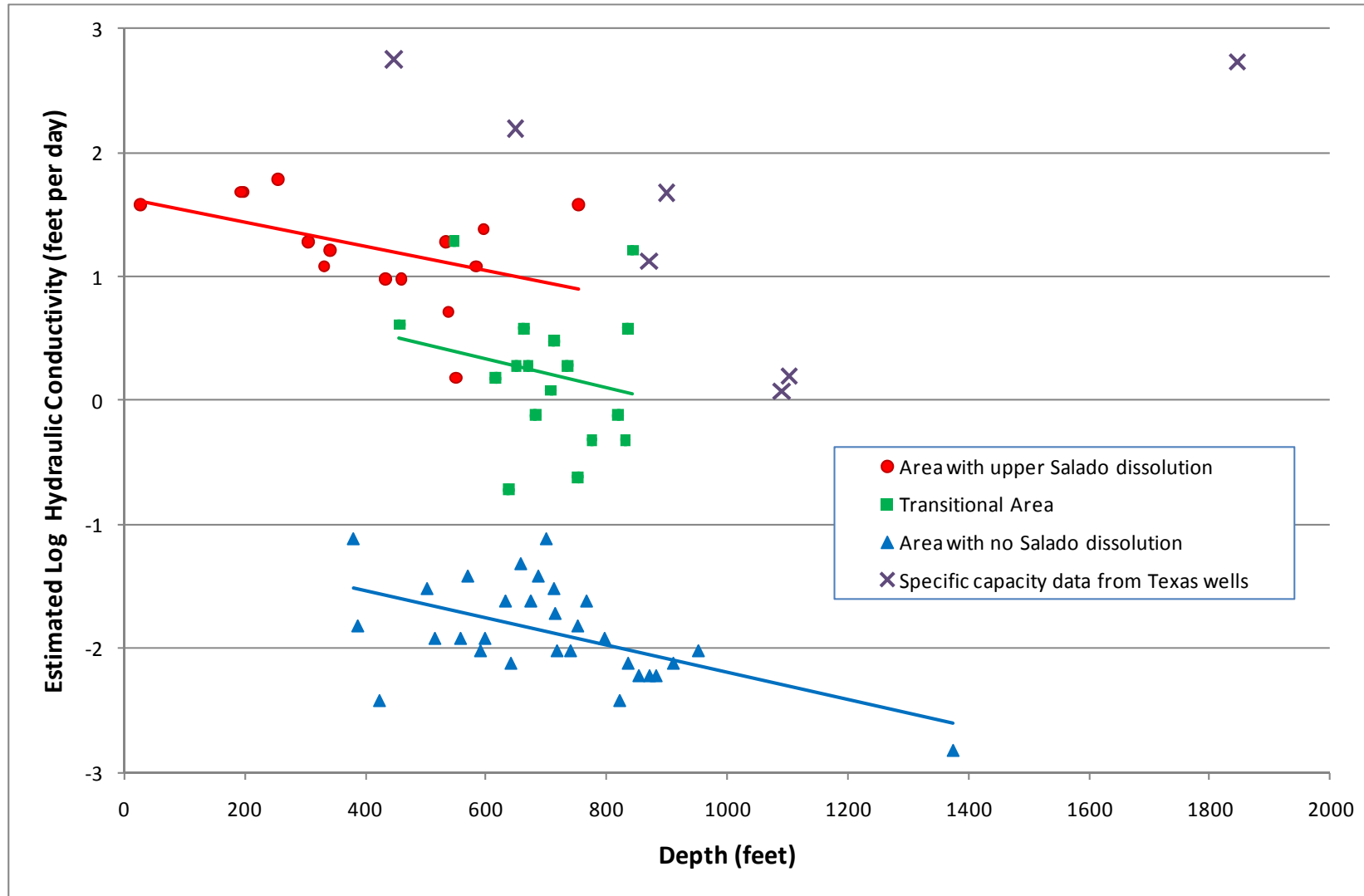

Figure 4.6.4 Estimated hydraulic conductivity of the Culebra Dolomite Member of the Rustler Formation in Eddy County, New Mexico with estimated hydraulic conductivity calculated from specific capacity data for Rustler Formation wells in Texas (Myers, 1969; TWDB, 2010d).

Final Groundwater Availability Model for the Rustler Aquifer

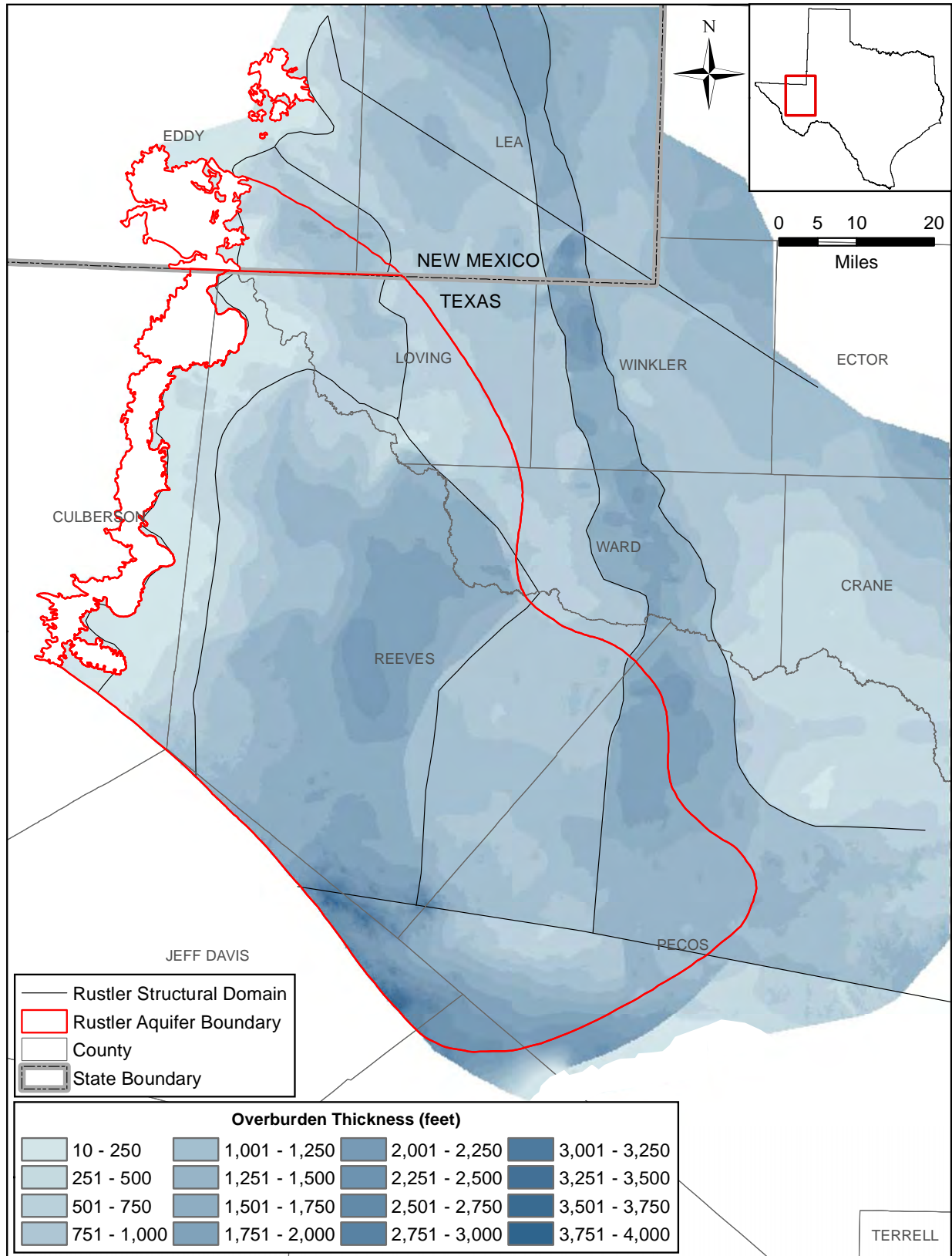

Figure 4.6.5 Thickness of overburden (in feet) above the Rustler Formation.

Final Groundwater Availability Model for the Rustler Aquifer

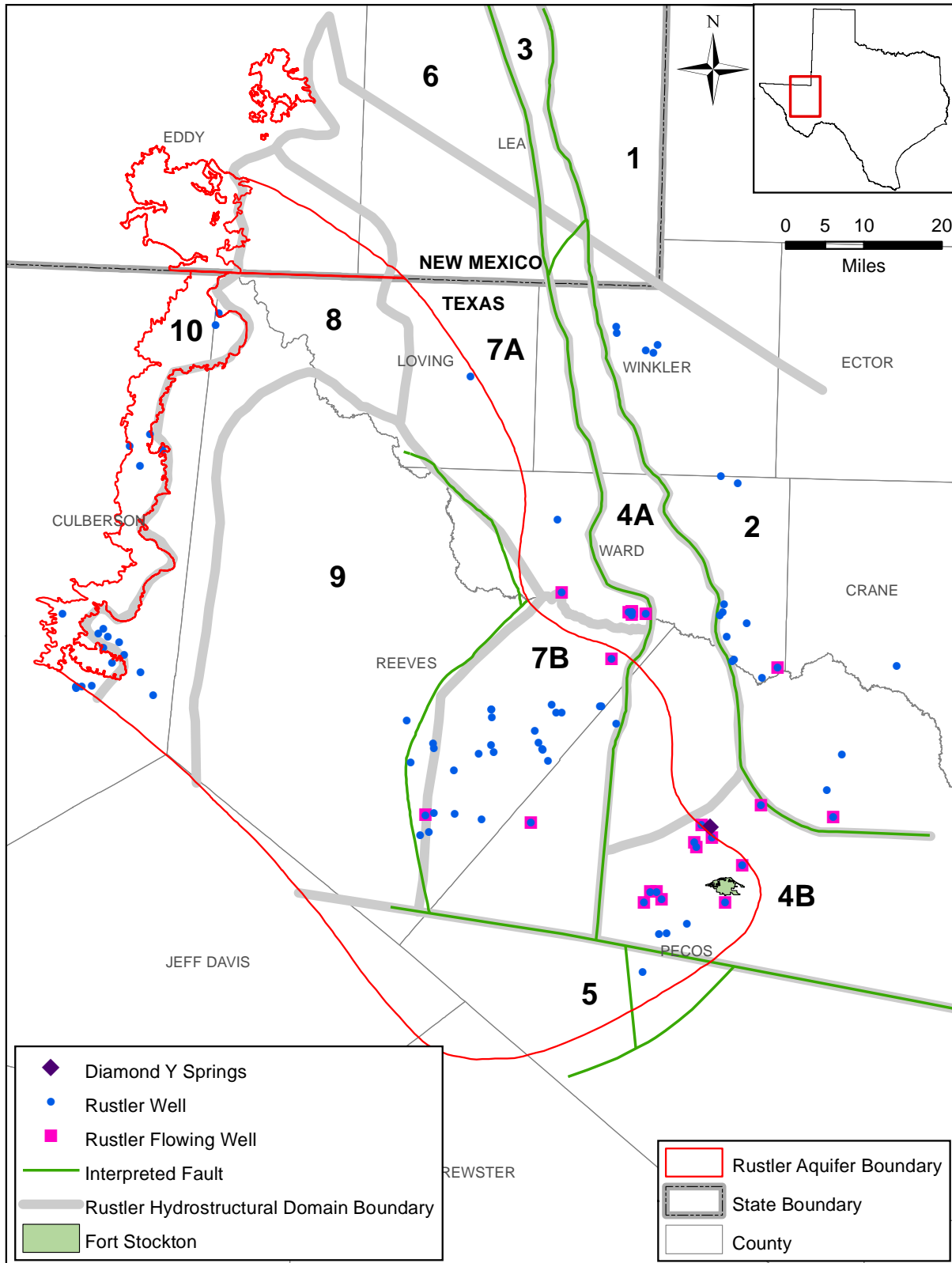

Figure 4.6.6 Hydrostructural domains developed for the Rustler Formation (TWDB, 2010c).

Final Groundwater Availability Model for the Rustler Aquifer

Hydrostructural Subdomain	5	4B	10	8	2	7B	7A	9	4A	6	3	1
Transmissivity (ft ² /day)	100,000		10,000						10	0.01		
Classification	Aquifer		Aquifer						Unknown	Outside Model		

Figure 4.6.7 Conceptual relationship between hydrostructural subdomains and relative transmissivity of the Rustler Formation.

4.7 Discharge

Discharge refers to water moving out of the aquifer, by one of several possible processes. The first group of processes discussed in this section are the natural ones, including discharge through streams, springs, evapotranspiration, and cross-formational flow. With the exception of evapotranspiration, these natural processes have been discussed in detail in previous sections. The second important discharge mechanism is via pumping.

4.7.1 Natural Aquifer Discharge

Under predevelopment conditions, without any pumping, aquifer recharge and discharge are balanced. In the typical topographically driven system, percolation of precipitation results in recharge at the water table, which flows from the topographic highs and discharges at the topographic lows through streams, springs, and groundwater evapotranspiration. Water that moves downdip eventually discharges upward through cross-formational flow. In the western portion of the Rustler Aquifer, which is usable primarily in or near the outcrop area, any water moving downdip exits into the Pecos River or overlying formations within a short distance, as evidenced by the generally poor downdip water quality.

Natural aquifer discharge via cross-formational flow is discussed in Section 4.3.4. Discharge through baseflow to the Pecos River is discussed in Section 4.5.1. Discharge through springs is discussed in Section 4.5.2. The remainder of the current section is focused on the remaining natural discharge mechanism, groundwater evapotranspiration.

Evapotranspiration is the combined process of soil water evaporation near the land surface and the uptake in the root zone and subsequent transpiration of water by vegetation. For the purposes of groundwater modeling, two types of evapotranspiration are distinguished: vadose zone evapotranspiration and groundwater evapotranspiration. Evapotranspiration in the vadose zone captures infiltrating water before it reaches the water table. Groundwater evapotranspiration is plant uptake or surface evaporation of groundwater. Here, the focus is groundwater evapotranspiration, since it is the type implemented in the groundwater model. Vadose zone evapotranspiration is already accounted for in the recharge estimate.

Groundwater evapotranspiration occurs primarily in riparian buffer strips adjacent to streams (Scanlon and others, 2005). Riparian zones are not specifically mapped in Texas. Two methods can be used for defining the location of groundwater evapotranspiration in the model region. Either some fixed buffer around the streams can be defined as riparian areas, or the topographically lower areas can be assumed to be likely regions of groundwater evapotranspiration. In general, the goal is to create the potential for groundwater evapotranspiration in regions where the water table is near ground surface.

Because the outcrop of the Tessey Limestone occurs in a mountainous region (i.e., the Glass Mountains) the water table elevation is expected to be too far below ground surface for significant groundwater evapotranspiration to occur. However, some potential for groundwater evapotranspiration is expected in the outcrop of the Rustler Aquifer in Culberson County, near the Pecos River and other streams that occur in the outcrop.

Scanlon and others (2005) summarize the conceptual approach to estimating groundwater evapotranspiration. In general, if water tables are very near the surface, evapotranspiration will be close to the potential evapotranspiration, assuming there is some type of vegetative cover. Potential evapotranspiration and reference evapotranspiration are terms often used interchangeably. Reference evapotranspiration is defined as the evapotranspiration rate from a reference vegetation, often a short grass, that has unlimited available water. Potential evapotranspiration should not be confused with “pan evaporation”, which is the rate of water evaporation from an open pan. Potential evapotranspiration can be related to pan evaporation by the use of pan coefficients; however, since potential evaporation can be estimated with basic climate data, pan evaporation is not used in the calculation of potential evapotranspiration.

When the water table is below ground surface, but still in the main vegetation root zone, evapotranspiration will occur at the unhindered vegetative evapotranspiration rate, ETV_{max}. This can be estimated by (Scanlon and others, 2005):

$$ETV_{max} = PET * K_c \quad (4.7.1)$$

where K_c is the vegetation coefficient and PET is the potential evapotranspiration. Thus, to parameterize groundwater evapotranspiration, three parameters must be estimated: potential

evapotranspiration, vegetation coefficient, and rooting depth. Rooting depth and vegetation coefficient are specific to the type of vegetation, so a necessary prerequisite is some knowledge of the types of vegetation in the riparian areas in the model region. The following paragraphs discuss how the types of vegetation in the model region were estimated, the corresponding vegetation coefficients and rooting depths, and potential evaporation in the area.

Borrelli and others (1998) provide an estimate of long-term potential evapotranspiration in Texas, based on the Penman-Monteith method, as reproduced in Figure 4.7.1 for the region near the Rustler Formation outcrop. This figure shows that the long-term average potential evapotranspiration ranges from about 73 to 77 inches per year, increasing from northwest to southeast. Although evapotranspiration varies considerably with seasons, it does not vary significantly on an annual average basis. For this reason, the assumption is made that potential evapotranspiration is constant throughout a transient simulation, where annual stress periods are used.

A detailed vegetation map in Texas is available from the Texas GAP (a geographic approach to planning for biological diversity) Analysis Project (Parker and others, 2003). Their estimates are based on a combination of geographic information system (GIS) analysis and ground truthing. Figure 4.7.2 shows an example of the vegetation coverage in Culberson County, in an area that includes Cottonwood Creek and China Draw. The vegetation types are labeled by their broad National Vegetation Classification System categories. The Texas Gap Analysis Project report names several possible subcategories for each main category that provide information on the specific types of vegetation in Texas that might be representative. However, they do not specifically identify riparian vegetation or riparian zones in their analysis. The most common vegetation types near the streams are Evergreen Extremely Xeromorphic Subdesert Shrubland and Extremely Xeromorphic Deciduous Shrubland. In between the streams, Short Sod Temperate or Subpolar Grassland predominates.

Relevant parameters for groundwater evapotranspiration can be estimated from Scanlon and others (2005), which provides a database of estimates of vegetation coefficient and rooting depths for many types of vegetation. Table 4.7.1 shows estimates for several types relevant to this region. The estimates of potential evapotranspiration, vegetation coefficient, and rooting

depth were used to estimate groundwater evapotranspiration parameters on a cell-by-cell basis in the model.

4.7.2 Aquifer Discharge through Pumping

Pumping discharge estimates for each county in the active model area were developed for the period from 1919 through 2008 for the transient model. The following discussion describes the methodology used in deriving the pumping by county for first the period from 1980 through 2008 and second the period prior to 1980.

Pumping for the Period from 1980 through 2008

Estimates of groundwater pumping from the Rustler Aquifer throughout Texas for the years 1980 through 1997 are provided by the Texas Water Development Board (TWDB) as master pumpage tables contained in a pumpage geodatabase. The six water-use categories defined in the TWDB database are municipal, manufacturing, power generation, mining, livestock, and irrigation. Each water use record in the database carries an aquifer identifier, which was used to select pumping records for the Rustler Aquifer. The pumpage geodatabase is a major source of pumpage for the Rustler GAM.

The study area intersects the following counties in Texas: Crane, Culberson, Loving, Pecos, Reeves, Ward, and Winkler. Query results from the TWDB pumpage database provided the total pumpage in the six categories for all counties with potential pumpage from the Rustler Aquifer. These queries indicated that there was no pumpage for the municipal, manufacturing, and power generation categories for any of these counties. The queries also showed that Loving County did not have any pumpage from the Rustler Aquifer in the 1980 to 1997 period.

The pumpage for mining was matched to the specific wells from which it was pumped to identify the withdrawal location in the aquifer (latitude, longitude, and depth above mean sea level) based on the well's reported properties. When more than one well is associated with a given water user, groundwater withdrawals were divided evenly among those wells.

Livestock pumpage totals within each county-basin that could not be associated with a specific well were distributed using information from land use maps as well as the TWDB groundwater database, which identifies livestock wells drawing from the Rustler Aquifer. Similarly, irrigation

pumpage totals not attributable to specific wells were distributed using information from irrigated farmland surveys performed in 1998 and 1994 by the Natural Resources Conservation Service of the United States Department of Agriculture and the TWDB groundwater database, which identifies irrigation wells drawing from the Rustler Aquifer.

Rural domestic pumpage, which consists primarily of unreported domestic water use, was assumed to occur only in the outcrop area in areas with rural-domestic wells. The TWDB has provided a polygon feature class of census blocks, based on the 1990 United States census, and a table of factors for converting rural population density into annual groundwater use. Rural domestic pumpage was estimated based on population density, per capita-usage rates (provided by the TWDB), and the percentage of area of each census block inside the Rustler Aquifer outcrop. In this analysis, only those census blocks that contained domestic wells from the TWDB groundwater database were considered. Figure 4.7.3 shows the census blocks in Texas that intersect the aquifer outcrop and the rural domestic well in the outcrop identified from the TWDB groundwater database. Culberson and Reeves counties were the only counties in Texas with Rustler Aquifer outcrop. Of these, there was a single census block (with a total population of 10 people) in Culberson County that contained a domestic well (from the TWDB groundwater database) and was, thus, used to estimate rural domestic pumpage from the Rustler Aquifer. Consequently, rural domestic pumpage from the aquifer is very small compared to the other categories (primarily mining, irrigation, and livestock) and may, in fact, be safely ignored without influencing the model. Because of the lack of rural domestic well data for New Mexico and the evidence that negligible rural domestic pumpage occurs in Texas, rural domestic pumpage in the Rustler Formation outcrop in New Mexico was also assumed to be negligible.

The TWDB provides historical water use information (<http://www.twdb.texas.gov/wushistorical/>) that contains pumpage for each county, each aquifer (including the Rustler Aquifer), and each water use type for the years 1980 and 1984 through 2008. For pumpage for 1980 to 1997, a comparison between the two data sources (the pumpage geodatabase and this water use information) for the Rustler Aquifer shows general consistency for the years 1981 to 1997, except for pumpage in the rural domestic category (municipal category in the water use survey) and the mining category. Rural domestic pumpage from 1984 to 1997 in Culberson County, the only county that has rural domestic pumping in the study area, is greater from the

water use information than the values from the pumpage geodatabase, but still very small compared to the other categories. Mining pumpage from 1984 to 1997 for Crane County is also larger in the water use information than the values from the pumpage geodatabase. The values from the water use information were used for both of the categories. The pumpage for the years 1998 to 2008 of the transient model was taken directly from the water use information.

Pumping for the Period Prior to 1980

Detailed pumpage data are not available prior to 1980. A literature survey was conducted to obtain historical pumpage data. Pumpage data were collected from various sources including the TWDB groundwater database, published reports for counties intersecting the study area, the surveys of irrigation in Texas (TWDB, 1991), drillers' logs, and other related groundwater reports from the TWDB.

The TWDB groundwater database was used to identify the earliest time when a particular type of pumpage began in the Rustler Aquifer for a given county using the drilling date. Drillers' logs (TWDB, 2010d) also provide information on well pumpage, status, etc., which was utilized when estimating pre-1980 pumping.

TWDB (1991) provides irrigation related groundwater pumpage for the years 1958, 1964, 1969, 1974, 1979, 1984, and 1989. Rees (1987) reported total pumpage for the years 1958, 1964, 1969, 1974 and 1979 by categories (irrigation, public, industrial, domestic, and livestock) for each county. The irrigation pumping from Rees (1987) is consistent with that from TWDB (1991). Other data sources provide historical pumpage for other years for certain categories for specific counties. For example, Hood and Knowles (1952) and Ogilbee and others (1961) reported irrigation pumpage in Reeves County for the years 1940 and 1946 through 1959. Once all the data were collected from the different sources, pre-1980 pumpage scenarios were developed for each pumpage category for each county as follows:

1. Rees (1987) provides the total pumpage for each category (irrigation, public, industrial, domestic, and livestock) and all counties in the 'Trans-Pecos Region'. All Texas counties within the study area were part of this report. However, the report only gives the total pumping for each category for each county, without breaking it up for different aquifers. Thus, it was necessary to apportion part of the total pumpage to the Rustler

Aquifer. To do this, the average ratio of Rustler Aquifer pumpage to total pumpage (of a given pumpage type) for 1980 through 1984 (the earliest 5 year period in the TWDB pumpage database) in the county was calculated from the TWDB pumpage database. This ratio was assumed to be the same for the pre-1980 period and was used to apportion a part of the reported total pumpage in Rees (1987) to the Rustler Aquifer. Pumpage for intermediate years with no data was estimated by linearly interpolating (or extrapolating) the pumpage from years with pumping data. This method was used for irrigation, municipal, and livestock water use.

2. Several county reports (e.g., White, 1971; Armstrong and McMillion, 1961; Garza and Wesselman, 1959) as well as United States Geological Survey reports mention pumpage from the Rustler Formation for ‘water-flooding’ or secondary oil recovery before 1980 for Pecos, Ward, Winkler, and Crane counties. The methodology discussed above was applied as well for these counties to develop pre-1980 mining pumping. However, mining pumping from the Rustler Aquifer in the period from 1980 to 1997 was zero except for Crane County, leading to a zero average ratio of 1980 through 1984 Rustler Formation pumpage to total pumpage. Thus, using this method, the pre-1980 mining pumpage for Pecos, Ward, and Winkler counties would become zero, contradicting the information from the literature. Therefore, an alternative method had to be considered to estimate pre-1980 mining pumping for Pecos, Ward, and Winkler counties. For Pecos and Ward counties, available reports and drillers’ logs were used to identify mining use, drilling date, plugged date, and pumping yields of specific Rustler Formation wells. When the drilling date was not available for a well, the year of the earliest water-level record was used to determine the starting year of pumpage. For wells with unknown pumping yields, an average yield of all the wells with known yields were calculated and used. For Winkler County, Garza and Wesselman (1959) state “Saline water - in 1952 several oil operators started using saline water for water-flooding. The water is treated before it is injected to inhibit corrosion. Some operators use moderately saline water from the oil strata in the Seven Rivers and Grayburg formations; others use water from the Rustler formations. Most of the water from the Rustler formation used for waterflooding in 1956 was highly saline. Some was moderately saline and a small part was considered a brine, having more than 35,000 ppm of dissolved solids.” Based on this

statement, it was assumed that all the high saline water pumpage for Winkler County was from Rustler Formation. Garza and Wesselman (1959) provide estimates of high saline water pumpage and total waterflooding pumpage from 1943 through 1956. The high saline water pumpage from this county report was, thus, adopted as the Rustler Formation mining pumpage for Winkler County.

3. Culberson County was the only county with any rural-domestic pumpage in the period from 1980 to 1997. None of the available literature gave any information regarding rural-domestic pumping from the Rustler Aquifer. The earliest date associated with any rural-domestic well in Culberson County was found to be 1960 (from drillers' logs). Thus, rural-domestic pumpage was interpolated from the value in 1980 (as derived through the methodology discussed in the previous section) to zero in 1959.
4. Once the above steps were completed, a linear interpolation was conducted to estimate pumpage for other unknown years for each county and each water-use type. The TWDB groundwater database was used to estimate the earliest pumping well for a certain kind of pumpage in the county. The years before this period were assumed to have zero pumpage.

Pumpage Results

The results from the analysis of pumpage in the Rustler Aquifer are summarized by use category in Tables 4.7.2 to 4.7.6. Figure 4.7.4 provides a bar chart of total pumpage by category for the Rustler Aquifer. Pumping history by use for each of the six counties with pumpage (since Loving County did not have any evidence of pumpage it is not shown) are shown in Figures 4.7.5 to 4.7.10.

Mining and livestock were the dominant water-use types for pumpage in Crane County. Culberson County shows the very small (less than 0.5 acre-feet per year) rural domestic pumpage. Irrigation and livestock is the dominant water-use types for pumpage in Reeves County. Mining pumpage was the dominant type for Pecos, Ward, and Winkler counties in the pre-1980 period. For these counties, mining was highest in the 1950s and decreased to a value of zero in the post-1980 period. Pecos County shows a steep rise in irrigation pumpage starting in 1994.

Final Groundwater Availability Model for the Rustler Aquifer

Table 4.7.1 Estimates of vegetation coefficient and rooting depth for several vegetation types in the study area (from Scanlon and others, 2005).

Vegetation Type	Vegetation Coefficient	Rooting Depth (feet)
Shrubland	0.53	9.2
Grassland	0.62	2
Conifer	0.37	7
Cropland	0.6*	1

*estimated from analogs

Table 4.7.2 Irrigation pumpage (in acre-feet per year) from the Rustler Aquifer and Rustler Formation by county.

Year	County							Total Irrigation
	Crane	Culberson	Loving	Pecos	Reeves	Ward	Winkler	
1936								
1937				2	4			6
1938				5	7			12
1939				7	11			18
1940				10	14			24
1941				12	15			27
1942				15	16			31
1943				17	17			34
1944				20	17			37
1945				22	18			40
1946				25	19			44
1947				27	21			48
1948				30	91			121
1949				32	131			163
1950				35	209			244
1951				37	425			462
1952				40	555			595
1953				42	686			728
1954				45	516			561
1955				47	457			504
1956				50	451			501
1957				52	470			522
1958				55	438			493
1959				56	457			513
1960				57	471			528
1961				57	484			542
1962				58	498			556
1963				59	512			571
1964				60	525			585

Final Groundwater Availability Model for the Rustler Aquifer

Table 4.7.2, continued

Year	County							Total Irrigation
	Crane	Culberson	Loving	Pecos	Reeves	Ward	Winkler	
1965				55	506			561
1966				49	486			535
1967				43	467			510
1968				38	447			485
1969				32	428			460
1970				32	421			453
1971				31	415			446
1972				31	409			440
1973				30	402			432
1974				30	396			426
1975				27	345			372
1976				24	295			319
1977				21	244			265
1978				18	194			212
1979				15	143			158
1980				10	139			149
1981				13	129			142
1982				16	120			136
1983				19	110			129
1984				22	100			122
1985				20	70			90
1986				17	67			84
1987				15	45			60
1988				15	57			72
1989				17	82			99
1990				16	43			59
1991				15	37			52
1992				15	36			51
1993				18	446			464
1994				1,283				1,283
1995				1,483				1,483
1996				1,357				1,357
1997				1,396				1,396
1998				1,430				1,430
1999				1,404				1,404
2000				1,309				1,309
2001				1,162				1,162
2002				1,108				1,108
2003				681				681
2004				1,223	2,053			3,276
2005				1,184	1,090			2,274
2006				1,783	1,052			2,835
2007				1,571	696			2,267
2008				1,639	1,305			2,944

Final Groundwater Availability Model for the Rustler Aquifer

Table 4.7.3 Livestock pumpage (in acre-feet per year) from the Rustler Aquifer and Rustler Formation by county.

Year	County							Total Livestock
	Crane	Culberson	Loving	Pecos	Reeves	Ward	Winkler	
1918								
1919		1						1
1920		2						2
1921		3						3
1922		4						4
1923		5						5
1924		6						6
1925		7						7
1926		8						8
1927		9						9
1928		10						10
1929		12						12
1930		13						13
1931		14						14
1932		15						15
1933		16						16
1934		17						17
1935		18						18
1936		19						19
1937		20			3			23
1938		21			6			27
1939		22			10			32
1940		23			13			36
1941		24			16			41
1942		25		1	19			45
1943		26		1	23			50
1944		27		1	26			54
1945		28		1	29			58
1946		29		2	32			63
1947		30		2	36			68
1948		31		2	39			72
1949		33		3	42			78
1950		34		3	45			82
1951		35		3	49			87
1952		36		3	52			91
1953		37		4	55			96
1954		38		4	58			100
1955		39		4	62			105
1956		40		5	65			110
1957		41		5	68			114
1958		42		5	71			118

Final Groundwater Availability Model for the Rustler Aquifer

Table 4.7.3, continued

Year	County							Total Livestock
	Crane	Culberson	Loving	Pecos	Reeves	Ward	Winkler	
1959		42		5	71			118
1960		42		5	71			118
1961		42		5	71			118
1962		42		5	71			118
1963		42		5	71			118
1964		42		5	71			118
1965		42		5	71			118
1966		42		5	71			118
1967		42		5	71			118
1968		42		5	71			118
1969		42		5	71			118
1970		42		5	71			118
1971		42		5	71			118
1972		42		5	71			118
1973		42		5	71			118
1974		42		5	71			118
1975		42		5	71			118
1976		42		5	71			118
1977		42		5	71			118
1978		42		5	71			118
1979		42		5	71			118
1980		41		5	86			132
1981		38		5	96			139
1982		36		5	106			147
1983		33		5	116			154
1984		30		5	126			161
1985		33		5	120			158
1986		28		2	118			148
1987		44		4	108			156
1988		47		3	49			99
1989		47		4	54			105
1990		46		4	59			109
1991		47		4	60			111
1992		31		5	91			127
1993		29		4	95			128
1994		26		4	92			122
1995		21		4	80			105
1996		23		4	102			129
1997		25		4	103			132
1998		34		3	35			72
1999		37		4	41			82
2000		33		4	41			78
2001		30		4	37			71
2002		47		3	36			86

Final Groundwater Availability Model for the Rustler Aquifer

Table 4.7.3, continued

Year	County							Total Livestock
	Crane	Culberson	Loving	Pecos	Reeves	Ward	Winkler	
2003		25	0	3	26	0	0	54
2004		29	1	14	0	1	0	45
2005		24	2	15	0	1	0	42
2006		27	3	17	0	1	0	48
2007		31	2	13	0	1	0	47
2008		31	1	15	0	2	0	49

Table 4.7.4 Rural domestic pumpage (in acre-feet per year) from the Rustler Aquifer and Rustler Formation by county.

Year	County							Total Rural Domestic
	Crane	Culberson	Loving	Pecos	Reeves	Ward	Winkler	
1937								
1938								
1939								
1940								
1941								
1942								
1943								
1944								
1945								
1946								
1947								
1948								
1949								
1950								
1951								
1952								
1953								
1954								
1955								
1956								
1957								
1958								
1959								
1960								
1961								
1962		1						1
1963		1						1
1964		1						1
1965		1						1

Final Groundwater Availability Model for the Rustler Aquifer

Table 4.7.4, continued

Year	County							Total Rural Domestic
	Crane	Culberson	Loving	Pecos	Reeves	Ward	Winkler	
1966		2						2
1967		2						2
1968		2						2
1969		2						2
1970		3						3
1971		3						3
1972		3						3
1973		3						3
1974		4						4
1975		4						4
1976		4						4
1977		4						4
1978		5						5
1979		5						5
1980		5						5
1981		5						5
1982		5						5
1983		5						5
1984		5						5
1985		4						4
1986		3						3
1987		4						4
1988		4						4
1989		3						3
1990		5						5
1991		5						5
1992		5						5
1993		6						6
1994								
1995		5						5
1996		5						5
1997		4						4
1998		5						5
1999		6						6
2000		4						4
2001								
2002								
2003								
2004		1						1
2005		1						1
2006		1						1
2007		1						1
2008		1						1

Final Groundwater Availability Model for the Rustler Aquifer

Table 4.7.5 Mining pumpage (in acre-feet per year) from the Rustler Aquifer and Rustler Formation by county.

Year	County							Total Mining
	Crane	Culberson	Loving	Pecos	Reeves	Ward	Winkler	
1940								
1941								
1942								
1943								
1944								
1945								
1946								
1947								
1948				68				68
1949				68				68
1950				354				354
1951				354				354
1952	8			1,143			125	1,276
1953	16			1,143		1,225	850	3,234
1954	24			1,143		1,225	1,100	3,492
1955	32			1,143		1,854	1,100	4,129
1956	40			1,143		1,854	950	3,987
1957	48			1,143		2,289	910	4,391
1958	56			1,094		2,289	871	4,309
1959	57			1,044		2,571	831	4,504
1960	59			994		2,571	792	4,416
1961	61			945		2,571	752	4,328
1962	62			895		2,571	713	4,241
1963	64			845		2,668	673	4,250
1964	65			795		2,668	633	4,162
1965	62			746		2,668	594	4,069
1966	59			696		2,668	554	3,977
1967	55			646		2,477	515	3,693
1968	52			597		2,287	475	3,410
1969	48			547		2,096	435	3,127
1970	48			497		1,906	396	2,846
1971	47			447		1,715	356	2,565
1972	46			398		1,524	317	2,285
1973	45			348		1,334	277	2,004
1974	44			298		1,143	238	1,723
1975	47			249		953	198	1,447
1976	51			199		762	158	1,170
1977	54			149		572	119	893
1978	57			99		381	79	617
1979	60			50		191	40	340
1980	74							74

Final Groundwater Availability Model for the Rustler Aquifer

Table 4.7.5, continued

Year	County							Total Mining
	Crane	Culberson	Loving	Pecos	Reeves	Ward	Winkler	
1981	61							61
1982	48							48
1983	48							48
1984	188							188
1985	75							75
1986	62							62
1987	81							81
1988	76							76
1989	61							61
1990	73							73
1991	134							134
1992	127							127
1993	83							83
1994	81							81
1995	12							12
1996	24							24
1997	52							52
1998	29							29
1999	52							52
2000	29							29
2001	22							22
2002	45							45
2003	64							64
2004	7							7
2005	7							7
2006	7							7
2007	7							7
2008	7							7

Table 4.7.6 Total pumpage (in acre-feet per year) from the Rustler Aquifer and Rustler Formation by county.

Year	County							Total
	Crane	Culberson	Loving	Pecos	Reeves	Ward	Winkler	
1919		1						1
1920		2						2
1921		3						3
1922		4						4
1923		5						5
1924		6						6
1925		7						7
1926		8						8
1927		9						9

Final Groundwater Availability Model for the Rustler Aquifer

Table 4.7.6, continued

Year	County							Total
	Crane	Culberson	Loving	Pecos	Reeves	Ward	Winkler	
1928		10						10
1929		12						12
1930		13						13
1931		14						14
1932		15						15
1933		16						16
1934		17						17
1935		18						18
1936		19						19
1937		20		2	7			29
1938		21		5	14			40
1939		22		7	20			50
1940		23		10	27			60
1941		24		13	31			68
1942		25		15	35			76
1943		26		18	39			84
1944		27		21	43			92
1945		28		24	47			99
1946		29		27	51			107
1947		30		29	57			116
1948		31		100	130			262
1949		33		103	173			308
1950		34		391	254			679
1951		35		394	473			902
1952	8	36		1,187	607		125	1,962
1953	16	37		1,189	741	1,225	850	4,058
1954	24	38		1,192	574	1,225	1,100	4,153
1955	32	39		1,195	519	1,854	1,100	4,738
1956	40	40		1,198	516	1,854	950	4,597
1957	48	41		1,200	538	2,289	910	5,027
1958	56	42		1,154	509	2,289	871	4,920
1959	57	42		1,105	529	2,571	831	5,135
1960	59	42		1,056	542	2,571	792	5,062
1961	61	42		1,007	556	2,571	752	4,989
1962	62	43		959	569	2,571	713	4,916
1963	64	43		910	583	2,668	673	4,940
1964	65	43		861	596	2,668	633	4,867
1965	62	43		806	577	2,668	594	4,749
1966	59	44		750	557	2,668	554	4,632
1967	55	44		695	538	2,477	515	4,324
1968	52	44		640	518	2,287	475	4,016
1969	48	44		584	499	2,096	435	3,707
1970	48	45		534	493	1,906	396	3,420
1971	47	45		484	486	1,715	356	3,133
1972	46	45		433	480	1,524	317	2,845

Final Groundwater Availability Model for the Rustler Aquifer

Table 4.7.6, continued

Year	County							Total
	Crane	Culberson	Loving	Pecos	Reeves	Ward	Winkler	
1973	45	45		383	474	1,334	277	2,558
1974	44	46		333	467	1,143	238	2,271
1975	47	46		280	417	953	198	1,941
1976	51	46		228	366	762	158	1,611
1977	54	46		175	315	572	119	1,281
1978	57	46		123	265	381	79	951
1979	60	47		70	214	191	40	622
1980	74	46		15	225			360
1981	61	43		18	225			348
1982	48	41		21	226			335
1983	48	38		24	226			336
1984	188	35		27	226			476
1985	75	37		25	190			327
1986	62	31		19	185			297
1987	81	48		19	153			301
1988	76	51		18	106			251
1989	61	50		21	136			268
1990	73	51		20	102			246
1991	134	52		19	97			302
1992	127	36		20	127			310
1993	83	35		22	541			681
1994	81	26		1,287	92			1,486
1995	12	26		1,487	80			1,605
1996	24	28		1,361	102			1,515
1997	52	29		1,400	103			1,584
1998	29	39		1,433	35			1,536
1999	52	43		1,408	41			1,544
2000	29	37		1,313	41			1,420
2001	22	30		1,166	37			1,255
2002	45	47		1,111	36			1,239
2003	64	25		684	26			799
2004	7	30	1	1,237	2,053	1		3,329
2005	7	25	2	1,199	1,090	1		2,324
2006	7	28	3	1,800	1,052	1		2,891
2007	7	32	2	1,584	696	1		2,322
2008	7	32	1	1,654	1,305	2		3,001

Final Groundwater Availability Model for the Rustler Aquifer

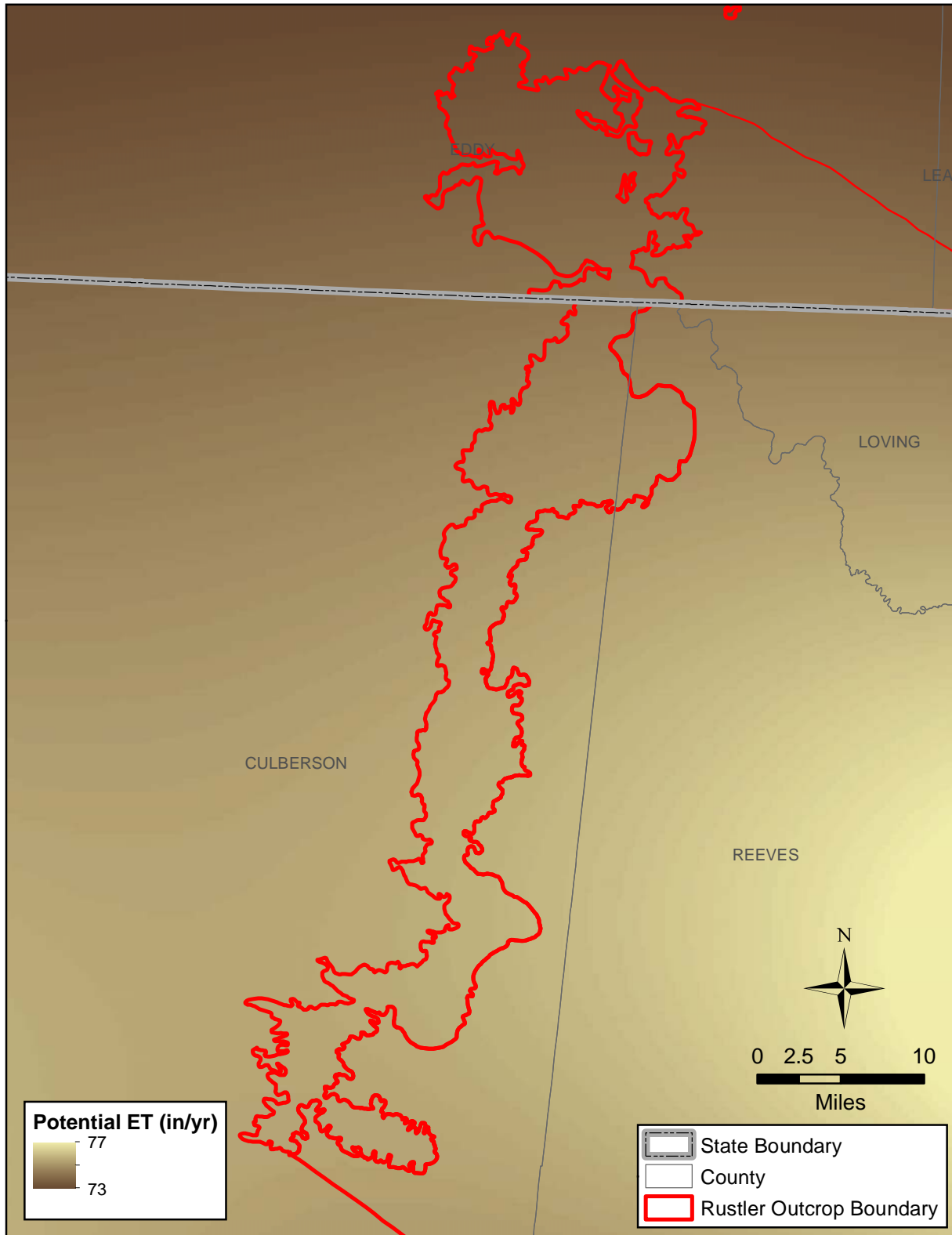

Figure 4.7.1 Potential evapotranspiration (in inches per year) in the Rustler Aquifer outcrop region (Borrelli and others, 1998).

Final Groundwater Availability Model for the Rustler Aquifer

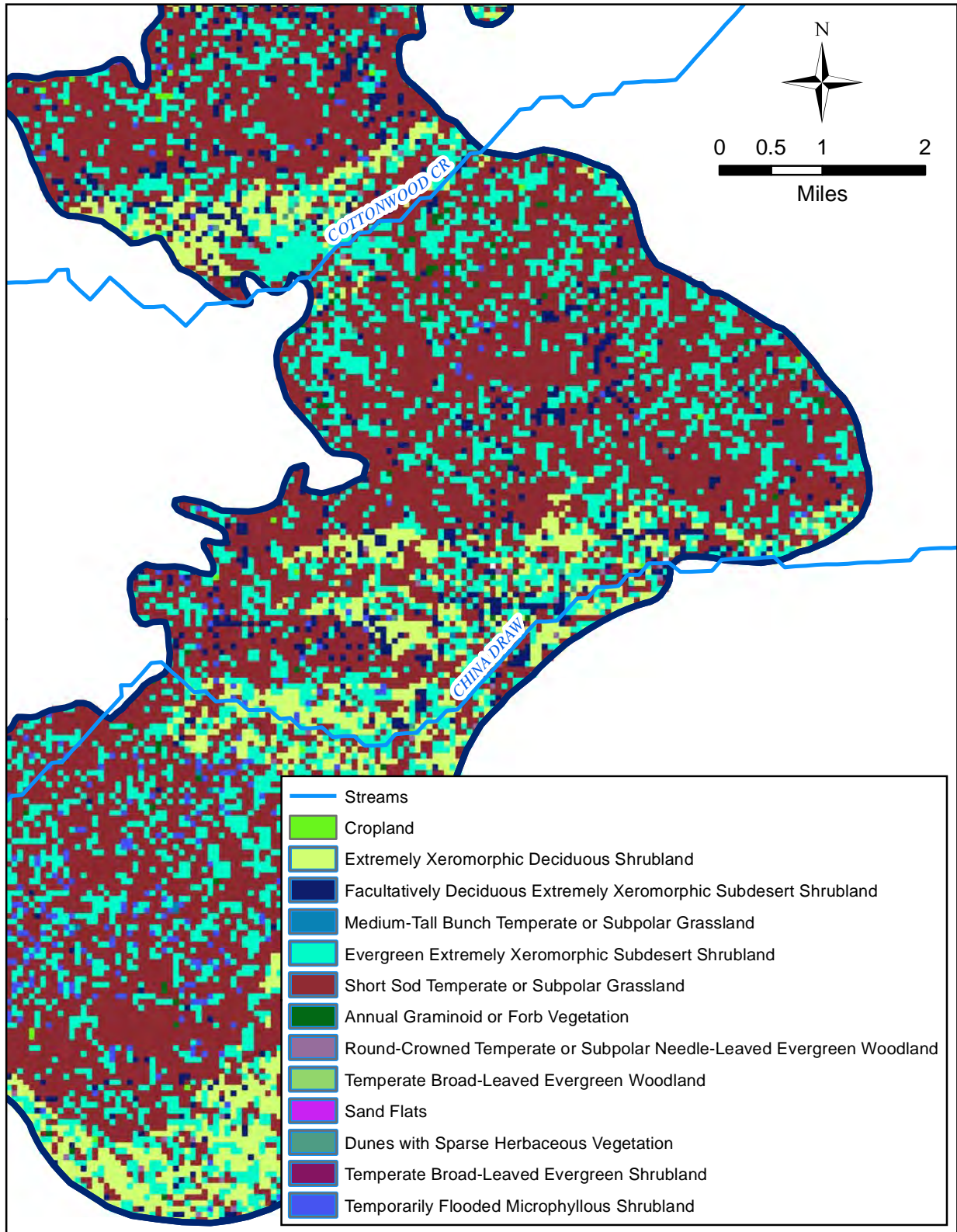

Figure 4.7.2 Example of Texas GAP Analysis Project vegetation coverage near Cottonwood Creek in Culberson County, Texas (Parker and others, 2003).

Final Groundwater Availability Model for the Rustler Aquifer

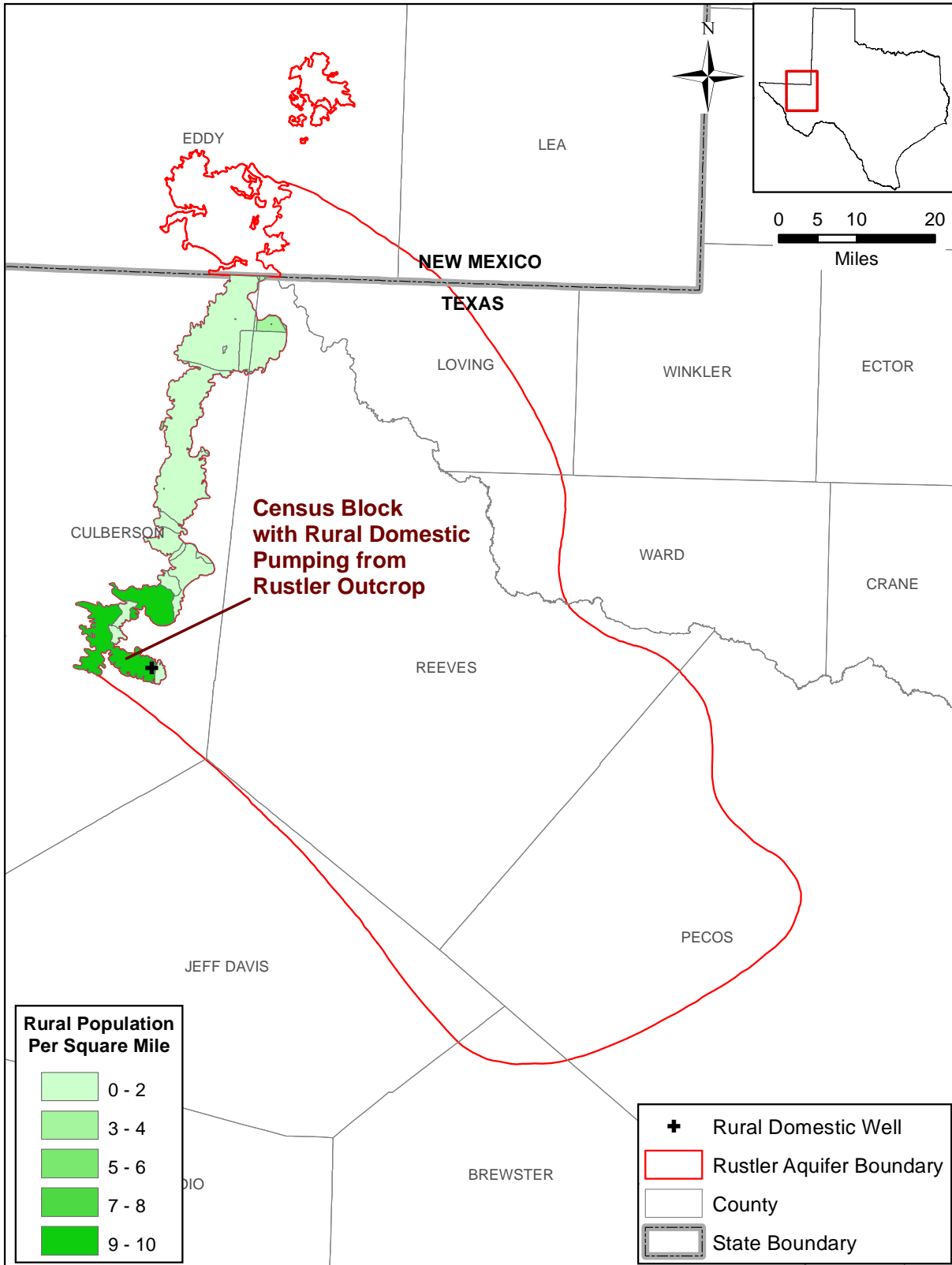

Figure 4.7.3 Rural population density in the Rustler Aquifer outcrop (TWDB, 2009b).

Final Groundwater Availability Model for the Rustler Aquifer

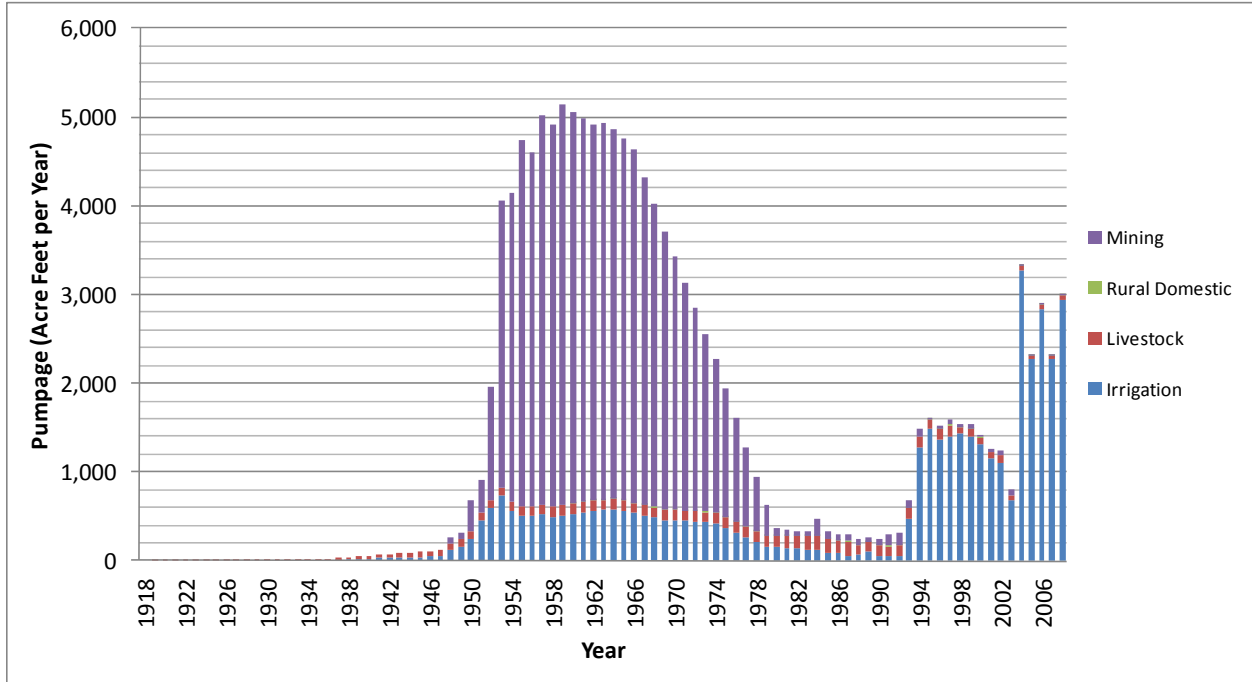

Figure 4.7.4 Total pumpage (in acre-feet per year) for the Rustler Aquifer and Rustler Formation.

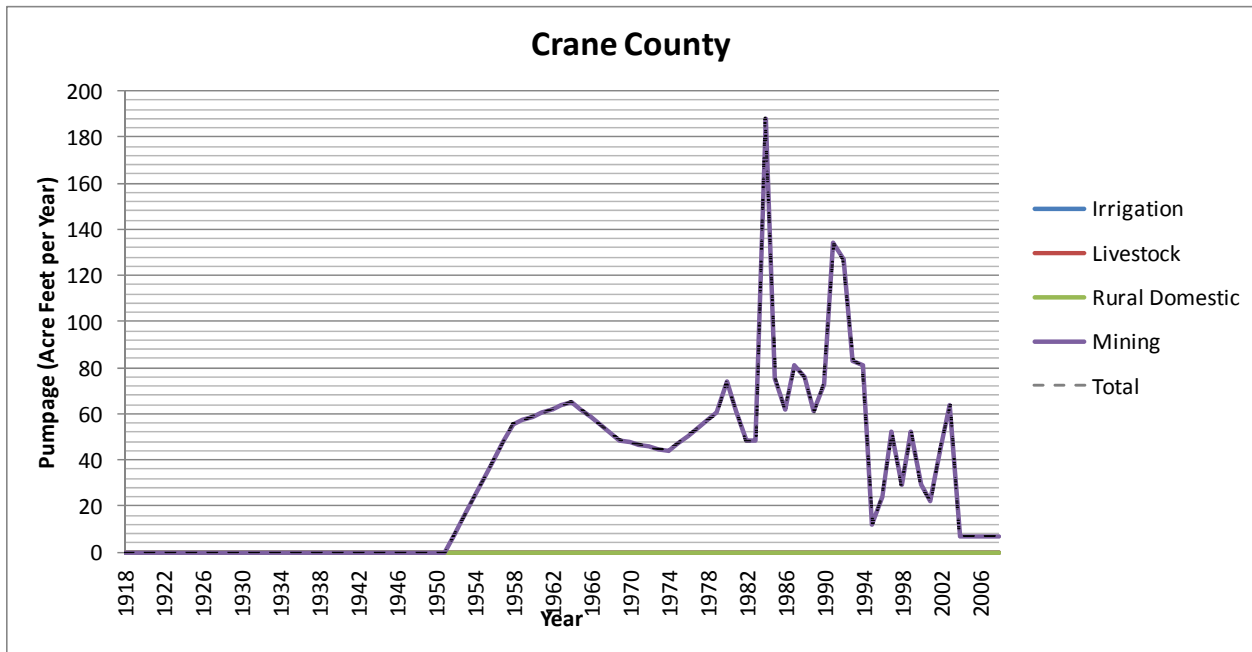

Figure 4.7.5 Total groundwater withdrawals (in acre-feet per year) from the Rustler Formation in Crane County.

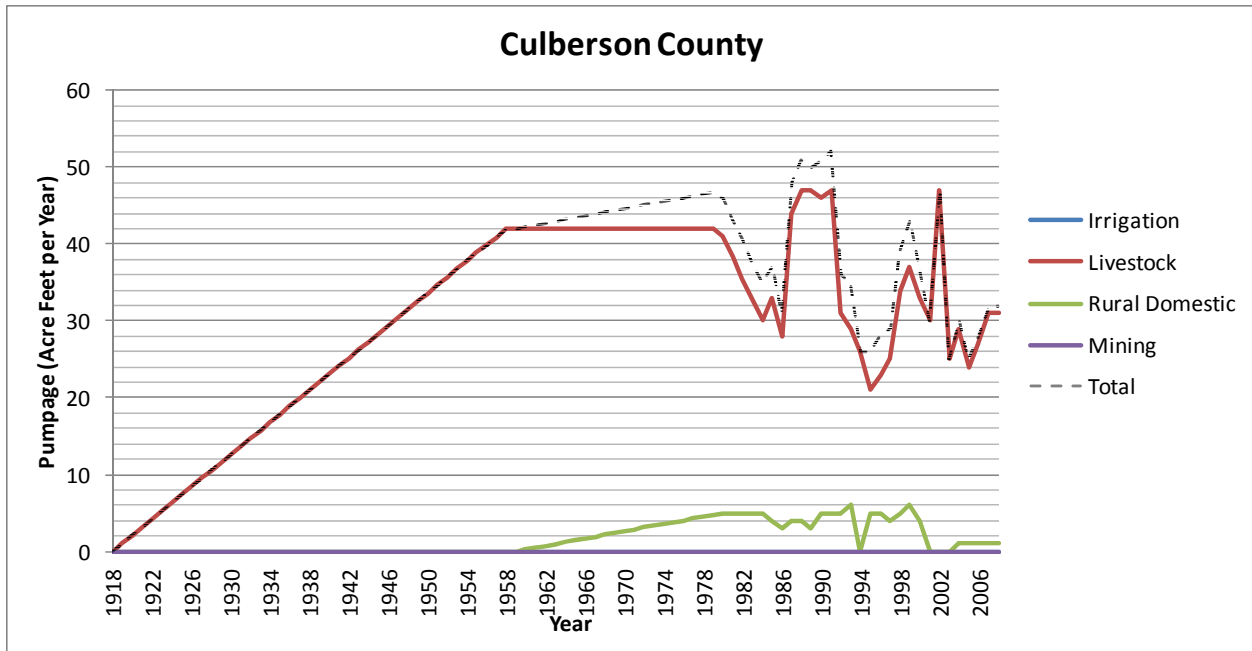

Figure 4.7.6 Total groundwater withdrawals (in acre-feet per year) from the Rustler Aquifer in Culberson County.

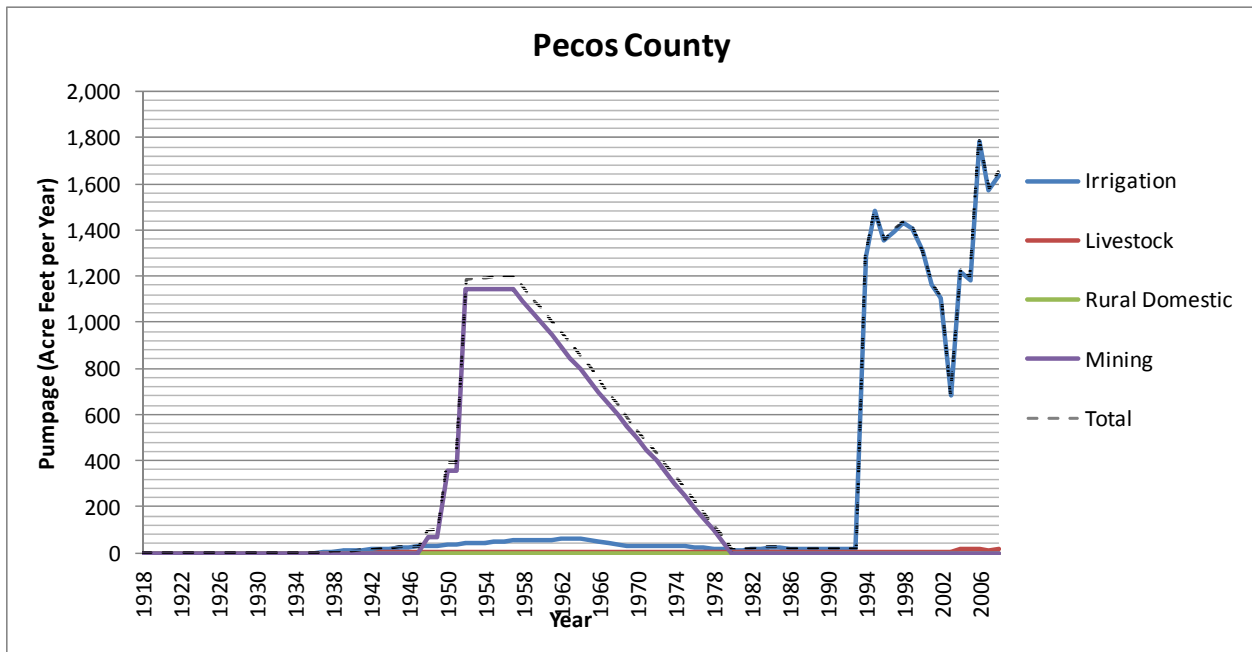

Figure 4.7.7 Total groundwater withdrawals (in acre-feet per year) from the Rustler Aquifer in Pecos County.

Final Groundwater Availability Model for the Rustler Aquifer

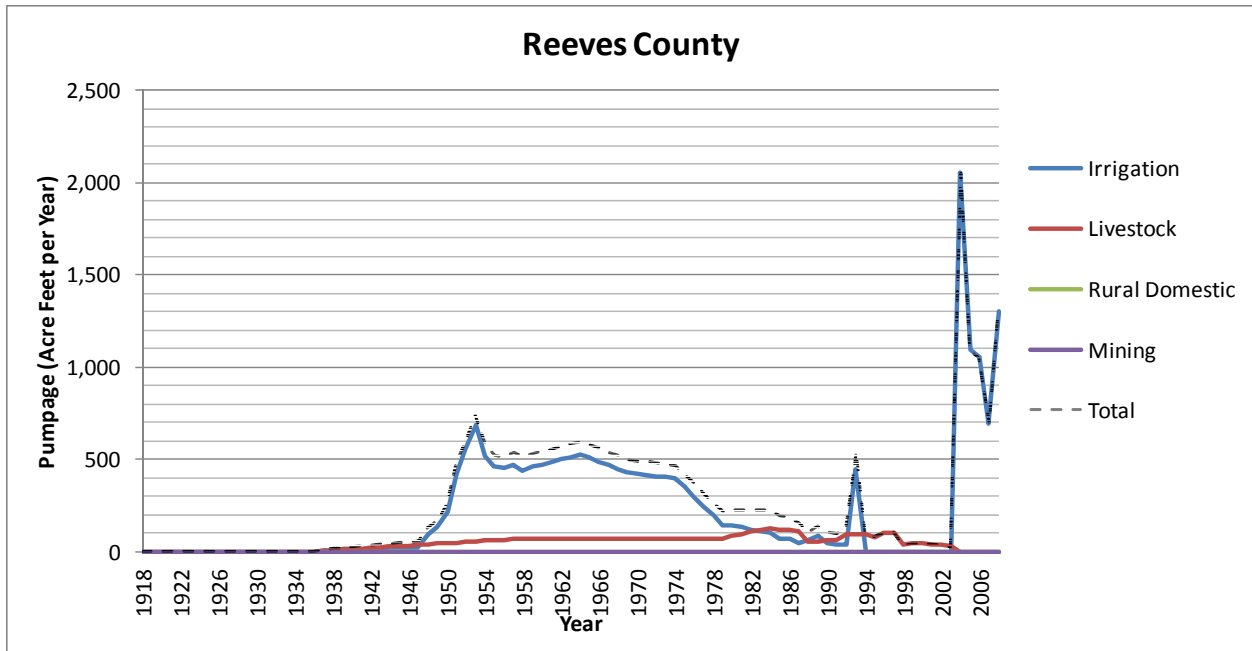

Figure 4.7.8 Total groundwater withdrawals (in acre-feet per year) from the Rustler Aquifer in Reeves County.

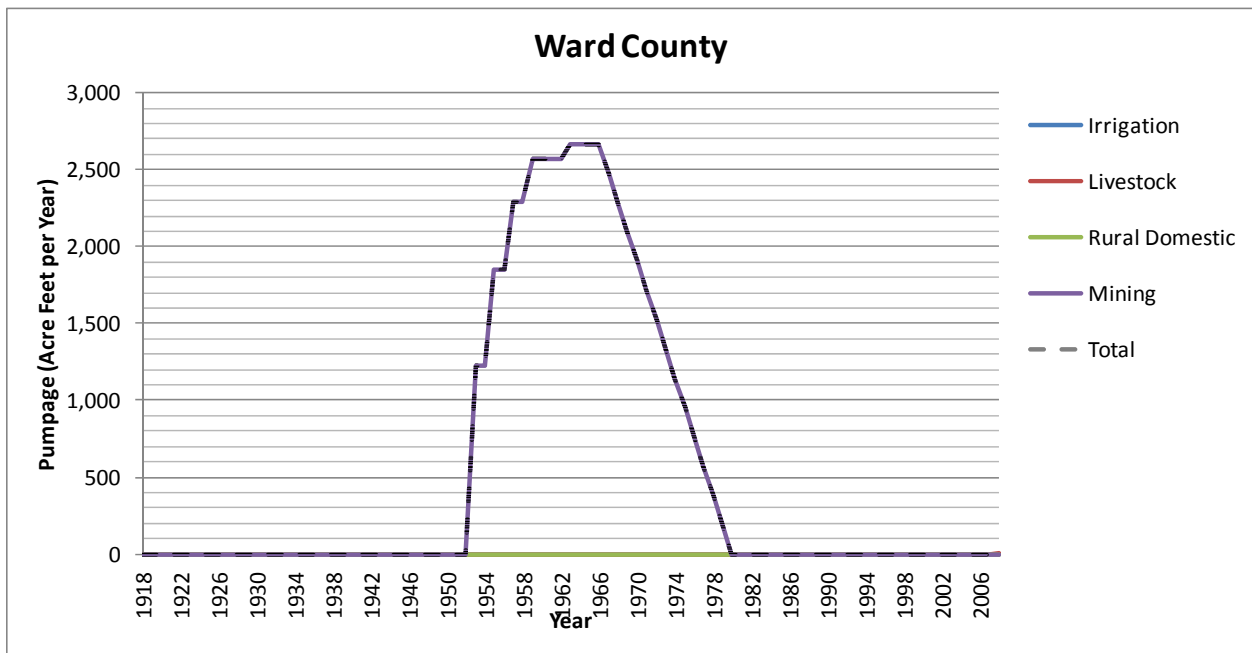

Figure 4.7.9 Total groundwater withdrawals (in acre-feet per year) from the Rustler Formation in Ward County.

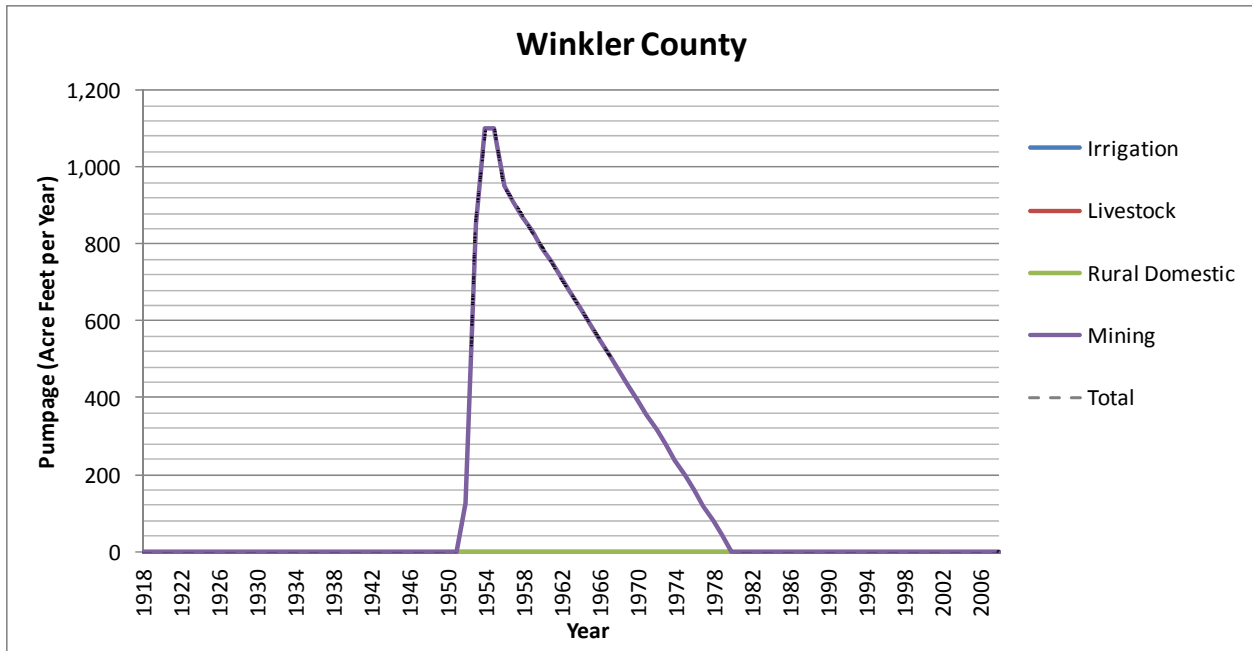

Figure 4.7.10 Total groundwater withdrawals (in acre-feet per year) from the Rustler Formation in Winkler County.

This page intentionally left blank.

4.8 Water Quality in the Rustler Aquifer

Groundwater quality is generally poor throughout the Rustler Aquifer, ranging from slightly saline to brine. Groundwater with a total dissolved solids concentration less than 1,000 milligrams per liter is found only in a small area in the southeastern Culberson County. Potable water is not found in significant amounts in the Rustler Aquifer. Common characteristics of groundwater in the Rustler Aquifer are typically high total dissolved solids concentrations, high calcium content, high sulfate content, and low bicarbonate content. The piper diagram in Figure 4.8.1 shows the chemical composition of the groundwater in the Rustler Aquifer based on available water-quality data.

Several studies on the quality of groundwater in the Rustler Aquifer are available. Winslow and Kister (1956) provide water-quality data for the Rustler Formation in their report on saline-water resources of Texas. A very brief discussion of the total dissolved solids concentrations of groundwater in the Rustler Aquifer is provided in Texas Water Commission (1989), which discusses the quality of groundwater in Texas. Groundwater samples collected in Rustler Aquifer wells in 1987 were analyzed by Small and Ozuna (1993). Boghici (1997) studied the chemistry of the groundwater in the Rustler Aquifer as it relates to the chemistry of water discharged at Diamond Y Springs. Brown (1998) analyzed 19 groundwater samples collected from the Rustler Aquifer from 1990 to 1995. The geochemistry of the Rustler Aquifer is reported by Boghici and Van Broekhoven (2001) based on review of 40 groundwater samples collected between 1956 and 2000.

In the current analysis, groundwater in the Rustler Aquifer was compared to drinking water standards and evaluated with respect to irrigation purposes. Water-quality measurements were retrieved for the entire available historical record from the TWDB groundwater database (TWDB, 2010c), found in published reports, and obtained from the United State Geological Survey in New Mexico.

4.8.1 Data Sources and Methods of Analysis

Wells completed into the Rustler Formation located both within and outside the boundary of the Rustler Aquifer are included in this analysis of the quality of the groundwater in the Rustler

Aquifer. Analyses of groundwater samples from 53 wells completed into the Rustler Formation are available in the TWDB groundwater database (TWDB, 2010c). Table 4.8.1 summarizes the number of wells from each county for which water-quality data are available. For each county, this table also includes an indication of whether the water-quality data in the TWDB groundwater database has undergone a quality assurance review. TWDB (2010e) warns that certain constituents are wrong and most metadata codes are blank for counties with water-quality data that has not been reviewed. Table 4.8.1 indicates that the water-quality data from the 8 wells located in Loving, Ward, and Winkler counties have been reviewed and the water-quality data from the 45 wells located in Crane, Culberson, Pecos, and Reeves counties have not been reviewed.

Each water-quality analysis in the TWDB groundwater database contains an analysis reliability remark. The six analyses marked as “collected from tank, distribution, or bailed from well” were not used in this analysis because they are not considered to be indicative of aquifer quality (Nordstrom and Quincy, 1999). Although the remark for several analyses indicated that the sample was collected from a well not sufficiently pumped or that the well was sufficiently pumped but not filtered or preserved, those results were used due to the overall sparseness of the water-quality data for the Rustler Formation.

Additional water-quality data are available from the Pecos, Reeves, and Winkler county reports (Armstrong and McMillion, 1961; Ogilbee and others, 1962; Garza and Wesselman, 1959; respectively) and a report on saline-water resources in Texas (Winslow and Kister, 1956) for 32 wells (see Table 4.8.1). Most of these wells are completed into the Rustler Formation; however, some were sampled in the Rustler Formation prior to being completed into a different formation. These data are not contained in the TWDB groundwater database and, therefore, they have not undergone a quality assurance review. The locations of the wells with water-quality data in these four reports were determined by georeferencing figures in the report and then digitizing the well locations. Consequently, there is some degree of uncertainty in the locations of these wells. Only data identified as for the Rustler Formation in the county reports and the Rustler limestone in Winslow and Kister (1956) were used.

Water-quality data are also available for two wells in Eddy County, New Mexico located in the portion of the Rustler Formation considered to be part of the Rustler Aquifer (Bowman, 2010). The type of review conducted on these samples is unknown.

The majority of the water-quality data for the Rustler Formation and all of the data for the portion of the formation making up the Rustler Aquifer have not undergone a rigorous quality assurance review. Therefore, the water-quality analysis presented here is considered uncertain.

For the purpose of statistical evaluation and mapping, the most recent sampling event for a given parameter was chosen from each well. The most recent data were used in order to assess the most current status of the quality of water in the Rustler Aquifer. Data are insufficient to evaluate changes in water quality with time.

4.8.2 Drinking Water Quality

Screening levels for drinking water supply are based on the maximum contaminant levels established in the Texas Administrative Code (Title 30 Chapter 290). Primary maximum contaminant levels are legally enforceable standards that apply to public water supplies to protect human health from contaminants in drinking water. Secondary maximum contaminant levels are non-enforceable guidelines for drinking water contaminants that may cause aesthetic effects (taste, color, odor, foaming), cosmetic effects (skin or tooth discoloration), and technical effects (corrosivity, expensive water treatment, plumbing fixture staining, scaling, and sediment).

Tables 4.8.2 and 4.8.3 summarize the occurrence and levels of some commonly measured groundwater quality constituents in the Rustler Formation and in the portion of the formation defined as the Rustler Aquifer, respectively. The percentage of samples exceeding the primary or secondary maximum contaminant level is greater than 10 percent in both the formation and the aquifer for chloride, fluoride, iron, sulfate, total dissolved solids, alpha activity, and combined radium 226 and radium 228.

Total dissolved solids, a measure of water salinity, is the sum of concentrations for all dissolved ions (such as sodium, calcium, magnesium, potassium, chloride, sulfate, carbonates) plus silica. Some dissolved solids, such as calcium, give water a pleasant taste, but most make water taste salty, bitter, or metallic. Dissolved solids can also increase the corrosiveness of water. Total

dissolved solids levels have exceeded the Texas secondary maximum contaminant level in approximately 92 percent of the wells in the Rustler Aquifer and 94 percent of the wells in the Rustler Formation. Figure 4.8.2 shows the total dissolved solids concentrations measured for groundwater samples from the Rustler Formation. Data are not sufficient to create contours. A total dissolved solids concentration less than 1,000 milligrams per liter is found only in a small area in southeastern Culberson County. With the exception of three wells, the total dissolved solids concentrations in the remaining portion of the Rustler Aquifer ranges from over 1,000 to 5,000 milligrams per liter. Brown (1998) suggests that the well with the extremely high total dissolved solids concentration in Loving County, which also has very high sodium and potassium concentrations, is contaminated by oil-field activities. In the outcrop area of the Rustler Aquifer, a total dissolved solids concentration greater than 3,000 milligrams per liter is found in four wells. Outside the boundaries of the Rustler Aquifer, concentrations less than 5,000 milligrams per liter are found in several places. The highest total dissolved solids concentrations in the Rustler Formation are typically found over the Central Basin Platform. There are insufficient data on the total dissolved solids concentrations in the Rustler Aquifer downdip of the outcrop in Culberson County, Texas and Eddy County, New Mexico to evaluate whether the water chemistry informs groundwater flow in this area of the aquifer.

The total dissolved solids concentrations in the Rustler Formation in Pecos County are lowest to the south and highest to the north along the Pecos River. This distribution of total dissolved solids concentrations is consistent with the assumption of recharge to the Rustler Aquifer through the Tessey Limestone in the Glass Mountains and northward groundwater flow towards the Pecos River. Recharge of the Rustler Aquifer through the Tessey Limestone is also consistent with apparent Carbon-14 age dating from Rustler Aquifer wells in Pecos County. Based upon two groundwater samples, Harden and others (2011) report apparent groundwater ages in the Rustler Aquifer of approximately 16,080 years old in the Belding Farms area and approximately 30,730 years old nearer to Diamond Y Springs. This is consistent with a distance recharge boundary of the Glass Mountain given that travel times over the distances of tens of miles would be expected to take thousands of years, especially when considering mixing of groundwater along an integrated flow path.

A contour map of total dissolved solids concentrations in the Rustler Formation was developed by the Ground Water Protection Unit staff of the Texas Water Commission (Texas Water Commission, 1989) and reproduced here in Figure 4.8.3. That figure, which was “modified from an unpublished map by R.D. Price, 1982, in the Texas Water Commission files” (Texas Water Commission, 1989), appears to be based on data not found for the current analysis as evident by the very high total dissolved solids concentrations near the city of Pecos, the “fingering” of the 3,000 milligram per liter contour line, and the 3,000 milligram per liter circle in Loving County. None of these features can be supported by the data found for the current analysis. An attempt was made to obtain or find the location of additional data from staff at the TWDB; however, that was not possible because the TWDB no longer has a groundwater protection or water-chemistry unit (Oliver, 2010).

Tables 4.8.2 and 4.8.3 show that concentrations of sulfate, a major component of total dissolved solids, have exceeded secondary maximum contaminant levels in over 98 percent the wells in both the Rustler Aquifer and the Rustler Formation. Figure 4.8.4 shows the locations where the sulfate concentration is below and exceeds the secondary maximum contaminant level of 300 milligrams per liter.

Concentrations of chloride have exceeded the secondary maximum contaminant level of 300 milligrams per liter in 23 and 38 percent of the wells in the Rustler Aquifer and Rustler Formation, respectively. Figure 4.8.5 shows that the chloride concentration is below the secondary maximum contaminant level throughout most of the Rustler Aquifer and exceeds the level at most locations outside the boundary of the aquifer.

High concentrations of nitrate can cause serious illness in infants younger than 6 months old. Approximately 6 and 9 percent of wells in the Rustler Aquifer and Rustler Formation, respectively, exceed the primary maximum contaminant level of 10 milligrams per liter for nitrate as nitrogen. The locations of wells with concentrations exceeding the primary maximum contaminant level for nitrate as nitrogen are found only in the outcrop and near subcrop of the formation (Figure 4.8.6).

pH is an indicator for acidity or alkalinity. In the Rustler Aquifer and Rustler Formation, the pH values at all the wells fall within the range of 6.5 to 8.5 defining the secondary maximum contaminant level.

Fluoride is a naturally-occurring element found in most rocks. At very low concentrations, fluoride is a beneficial nutrient. At a concentration of 1 milligram per liter, fluoride helps to prevent dental cavities. However, at concentrations above the secondary maximum contaminant level of 2 milligrams per liter, fluoride can stain children's teeth. Approximately 44 and 41 percent of wells in the Rustler Aquifer and Rustler Formation, respectively, have exceeded this level. At concentrations above the primary maximum contaminant level of 4 milligrams per liter, fluoride can cause a type of bone disease. None of the wells in the Rustler Aquifer or Rustler Formation have fluoride concentrations that exceeded 4 milligrams per liter. Figure 4.8.7 show the locations where the fluoride concentration falls below and exceeds the secondary maximum contaminant level.

Alpha activity is a measure of the total radioactivity due to the emission of alpha particles. At values greater than the primary maximum contaminant level of 15 picocuries per liter, alpha activity increases the risk of cancer. This level is exceeded in about 80 and 75 percent of the wells in the Rustler Aquifer and Rustler Formation, respectively. Wells with concentrations above and below primary maximum contaminant level are shown in Figure 4.8.8. Groundwater sampled from two wells located within the Rustler Aquifer exceeded the primary maximum contaminant level for combined radium 226 and radium 228. Brown (1998) indicates that the occurrence of radioactivity in the Rustler Formation is unusual because radioactivity is typically found in deep, uranium-rich aquifers, and the Rustler Formation is neither particularly deep nor uranium-rich. He speculates that the radioactivity observed in the Rustler Formation may be the result of cross-formational flow from deeper aquifers; but indicates this theory needs to be confirmed by further research.

In summary, groundwater from the Rustler Formation in general and the Rustler Aquifer specifically is not suitable for human consumption.

4.8.3 Irrigation Water Quality

The utility of groundwater from the Rustler Aquifer and Rustler Formation for crop irrigation was evaluated based on its salinity hazard, sodium hazard, and concentrations of chloride. The results of this evaluation are presented below.

Saline irrigation waters limit the ability of plants to take up water from soils. Various crops differ in their tolerance of high salinity. Salinity is often measured by the total dissolved solids content or electrical conductivity of the water. The salinity hazard classification system of the United States Salinity Laboratory (1954) indicates that water with a specific conductance over 750 micromhos per centimeter present a high salinity hazard, and those with a specific conductance over 2250 micromhos per centimeter present a very high salinity hazard. Of the wells in the Rustler Aquifer and Rustler Formation, 100 percent have a high salinity hazard and 78 and 82 percent, respectively, have a very high salinity hazard. Figure 4.8.9 shows the locations of wells with high and very high salinity hazard based on specific conductance values. In general, the a high salinity hazard is found in wells in the southern portion of the outcrop and near subcrop and a very high salinity hazard is found throughout the Rustler Formation both inside and outside the boundary of the aquifer.

Irrigation water containing large amounts of sodium causes a breakdown in the physical structure of soil such that the movement of water and air through the soil is restricted. The sodium hazard was calculated based on the classification system developed by the United States Salinity Laboratory (1954). The sodium absorption ratio is an indication of the sodium hazard to soils. The sodium adsorption ratio is calculated as follows:

$$\text{Sodium Adsorption Ratio} = \frac{Na}{\sqrt{\frac{Ca + Mg}{2}}} \quad (4.8.1)$$

where the sodium (Na), calcium (Ca), and magnesium (Mg) concentrations are expressed in milliequivalents per liter.

Waters with a sodium absorption ratio above 18 are considered to present a high sodium hazard, generally considered unsuitable for continuous use in irrigation. Waters with a sodium absorption ratio above 26 are considered to represent a very high sodium hazard. About

2 percent of the wells in Rustler Aquifer have exhibited a high sodium hazard, and 2 percent of the wells exhibited a very high sodium hazard. For the Rustler Formation, about 12 percent of the wells are considered to represent a high sodium hazard and 10 percent of the wells exhibited a very high sodium hazard. Figure 4.8.10 shows the locations and sodium hazard rating for the Rustler Formation. All wells with a very high sodium hazard are located on or near the portion of the formation overlying the Central Basin Platform, with the exception of the well in Loving County that Brown (1998) suspects is contaminated due to oil-field activities. Excluding this well, all wells in the Rustler Aquifer have a low or moderate sodium hazard.

Most crops cannot tolerate chloride levels above 1,000 milligrams per liter for an extended period of time (Tanji, 1990). This level has been exceeded in about 6 percent of wells in the Rustler Aquifer and 23 percent of the wells in the Rustler Formation (see Figure 4.8.5). Only a few wells have a chloride concentration above 1,000 milligrams per liter in the Rustler Aquifer, and one is the well in Loving County suspected to be contaminated due to oil-field activities.

Table 4.8.1 Number of wells with water-quality data by source type.

County	Number of Wells ¹				Water-Quality Data Reviewed ²
	TWDB GWDB	County Reports ³	Winslow and Kister (1956)	NM USGS	
Crane	1	-	1	na	No
Culberson	24	-	3	na	No
Loving	1	all	0	na	Yes
Pecos	10	8	5	na	No
Reeves	10	5	5	na	No
Ward	7	all	1	na	Yes
Winkler	0	2	0	na	Yes
Eddy, NM	na	na	na	2	na

¹ number of wells with water-quality data in the Texas Water Development Board groundwater database (TWDB GWDB), in the county reports (Armstrong and McMillion, 1961; Ogilbee and others, 1962; Garza and Wesselman, 1959), the saline water resources of Texas report (Winslow and Kister, 1956), and obtained from the United States Geological Survey, New Mexico Water Science Center.

² indicates whether the water-quality data in the TWDB GWDB has undergone a quality assurance review.

³ "-" indicates there is no county report for the county, "all" indicates all data in the county report is contained in the TWDB GWDB, and a value indicates the number of wells with water-quality data found in the county report but not in the TWDB GWDB.

Final Groundwater Availability Model for the Rustler Aquifer

Table 4.8.2 Occurrence and levels of some commonly measured groundwater quality constituents in the Rustler Formation.

Constituent	Type of Standard	Screening Level	Units	Number of Results	Number of Results Exceeding Screening Level	Percentage of Results Exceeding Screening Level
Fluoride	Primary maximum contaminant level ¹	4	mg/L	42	0	0
Nitrate	Primary maximum contaminant level ¹	10	mg/L as N	58	5	8.6
Alpha Activity	Primary maximum contaminant level ¹	15	pCi/L	16	12	75.0
Radium 226 and Radium 228 (combined)	Primary maximum contaminant level ¹	5	pCi/L	2	2	100.0
pH	Secondary maximum contaminant level ¹ (range)	6.5 to 8.5	-	61	0	0
Chloride	Secondary maximum contaminant level ¹	300	mg/L	90	34	37.8
Fluoride	Secondary maximum contaminant level ¹	2	mg/L	42	17	40.5
Iron	Secondary maximum contaminant level ¹	300	µg/L	27	8	29.6
Sulfate	Secondary maximum contaminant level ¹	300	mg/L	89	88	98.9
Total Dissolved Solids	Secondary maximum contaminant level ¹	1000	mg/L	82	77	93.9
Specific Conductance	Irrigation Salinity Hazard - High ²	750	µmhos/cm	66	66	100.0
Specific Conductance	Irrigation Salinity Hazard - Very High ²	2250	µmhos/cm	66	54	81.8
Sodium Absorption Ratio	Sodium hazard – High ²	18	-	58	7	12.1
Sodium Absorption Ratio	Sodium hazard – Very High ²	26	-	58	6	10.3
Chloride	Irrigation Hazard ³	1000	mg/L	90	21	23.3

¹ 30 Texas Administrative Code Chapter 290 Subchapter F

² United States Salinity Laboratory (1954)

³ Tanji (1990)

mg/L = milligrams per liter µmhos/cm = micromhos per centimeter pCi/L = picocuries per liter

Final Groundwater Availability Model for the Rustler Aquifer

Table 4.8.3 Occurrence and levels of some commonly measured groundwater quality constituents in the Rustler Aquifer.

Constituent	Type of Standard	Screening Level	Units	Number of Results	Number of Results Exceeding Screening Level	Percentage of Results Exceeding Screening Level
Fluoride	Primary maximum contaminant level ¹	4	mg/L	34	0	0
Nitrate	Primary maximum contaminant level ¹	10	mg/L as N	49	3	6.1
Alpha Activity	Primary maximum contaminant level ¹	15	pCi/L	15	12	80.0
Radium 226 and Radium 228 (combined)	Primary maximum contaminant level ¹	5	pCi/L	2	2	100.0
pH	Secondary maximum contaminant level ¹ (range)	6.5 to 8.5	-	46	0	0
Chloride	Secondary maximum contaminant level ¹	300	mg/L	65	15	23.1
Fluoride	Secondary maximum contaminant level ¹	2	mg/L	34	15	44.1
Iron	Secondary maximum contaminant level ¹	300	µg/L	25	8	32.0
Sulfate	Secondary maximum contaminant level ¹	300	mg/L	64	63	98.4
Total Dissolved Solids	Secondary maximum contaminant level ¹	1000	mg/L	62	57	91.9
Specific Conductance	Irrigation Salinity Hazard - High ²	750	µmhos/cm	49	49	100.0
Specific Conductance	Irrigation Salinity Hazard - Very High ²	2250	µmhos/cm	49	38	77.6
Sodium Absorption Ratio	Sodium hazard – High ²	18	-	43	1	2.3
Sodium Absorption Ratio	Sodium hazard – Very High ²	26	-	43	1	2.3
Chloride	Irrigation Hazard ³	1000	mg/L	65	4	6.2

¹ 30 Texas Administrative Code Chapter 290 Subchapter F

² United States Salinity Laboratory (1954)

³ Tanji (1990)

mg/L = milligrams per liter µmhos/cm = micromhos per centimeter pCi/L = picocuries per liter

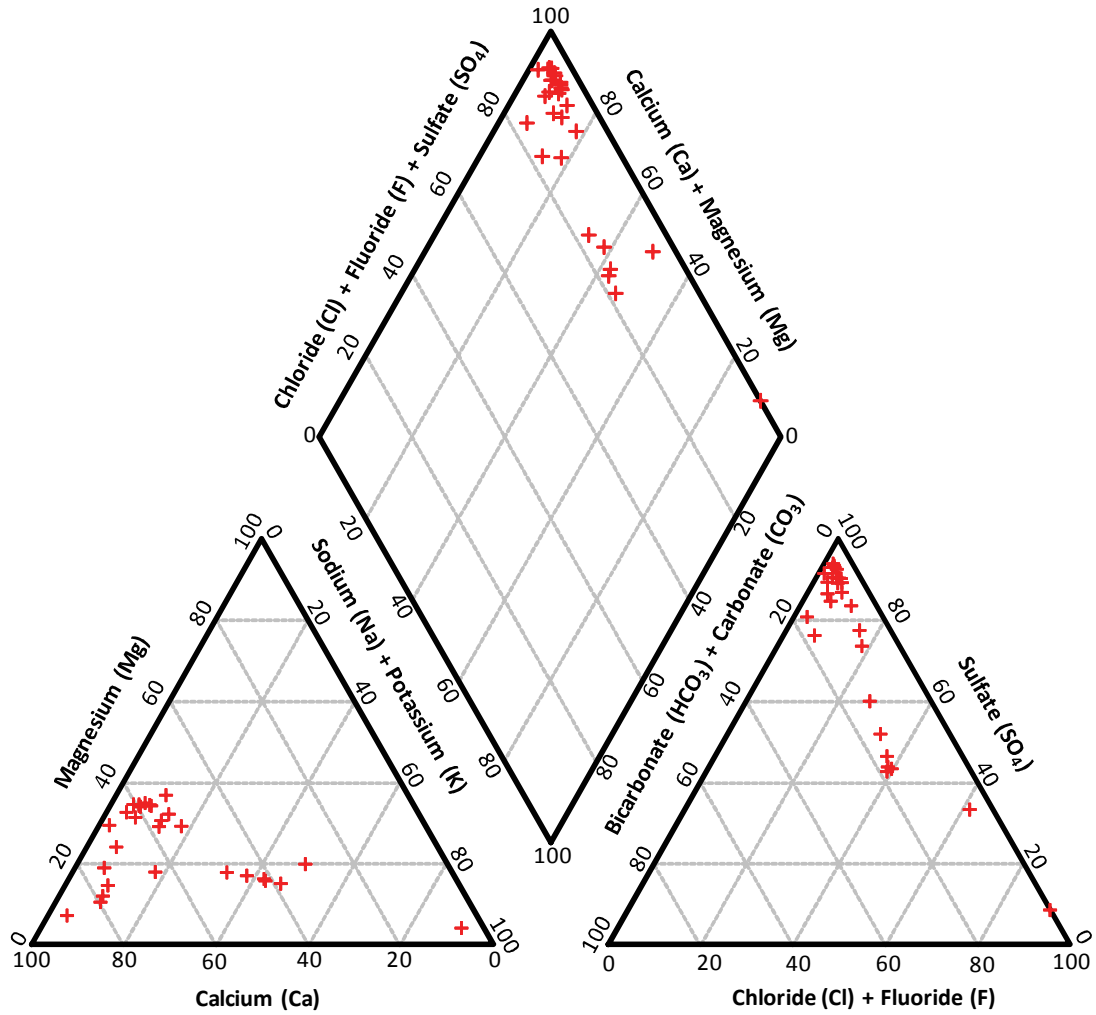

Figure 4.8.1 Piper diagram showing the chemical composition of groundwater in the Rustler Aquifer based on available water-chemistry data (TWDB, 2010c).

Final Groundwater Availability Model for the Rustler Aquifer

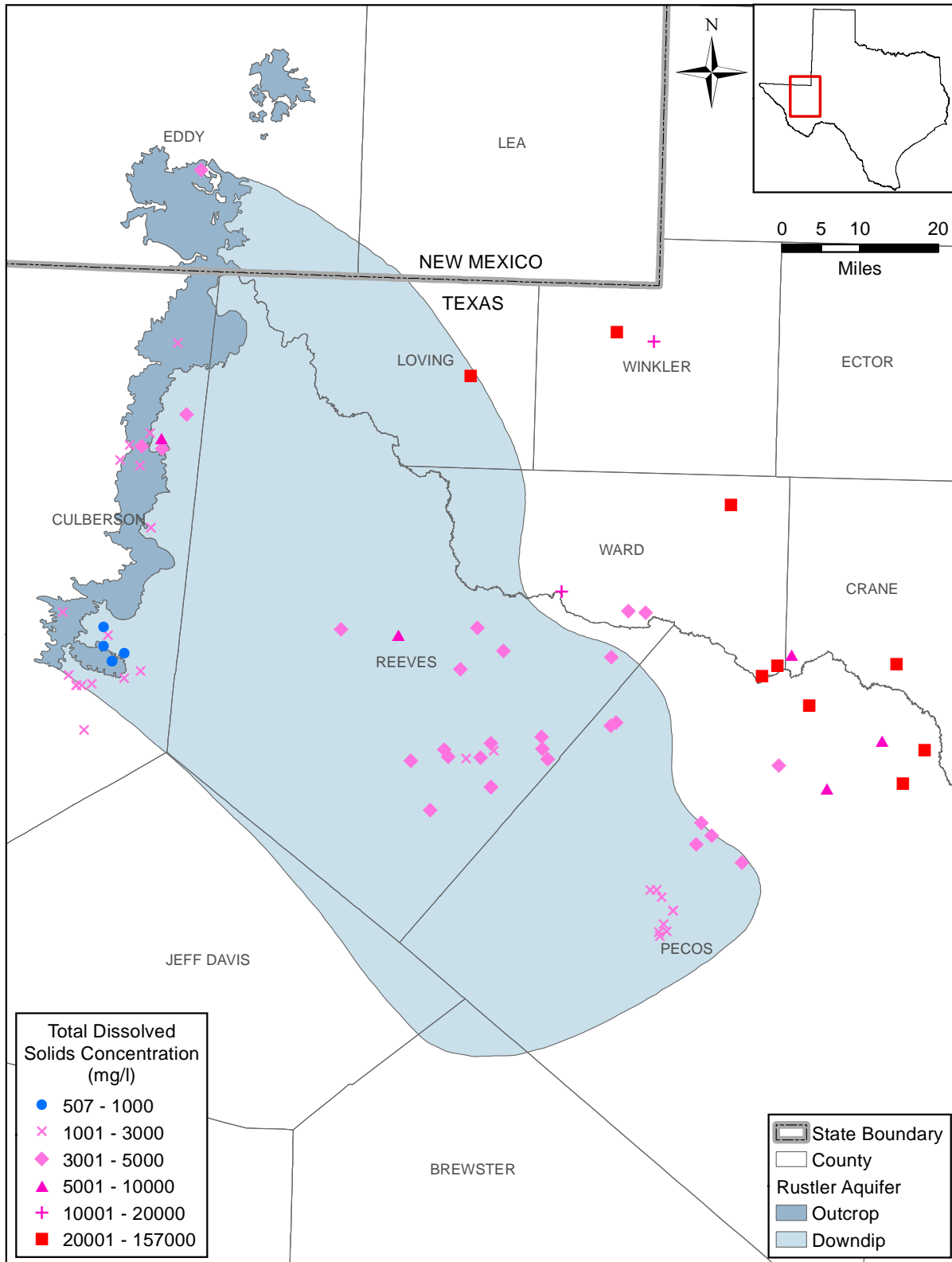

Figure 4.8.2 Total dissolved solids concentration (in milligrams per liter) in the Rustler Formation (Bowman, 2010; TWDB, 2010c).

Final Groundwater Availability Model for the Rustler Aquifer

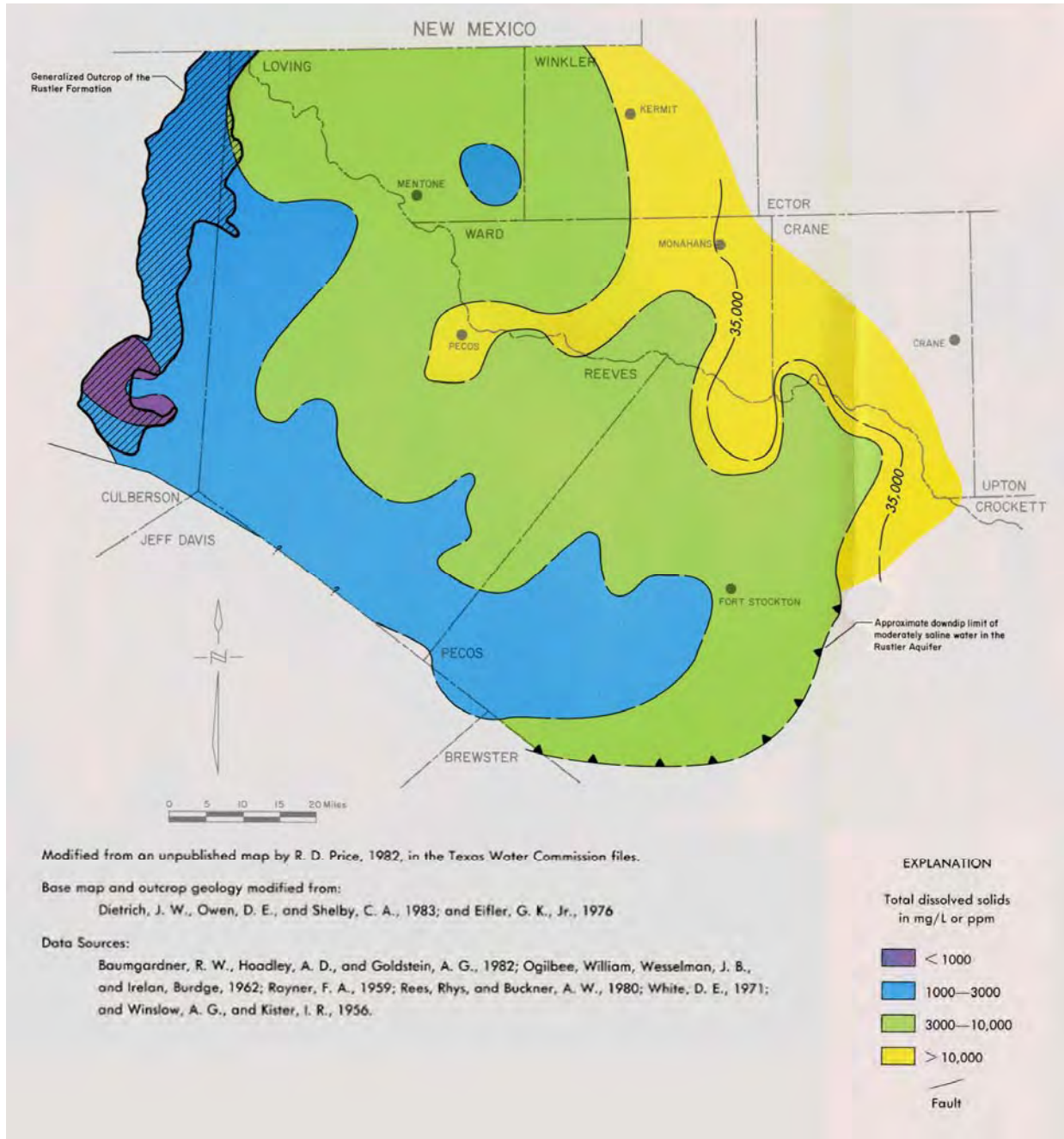

Figure 4.8.3 Ground-water quality in the Rustler Aquifer based on total dissolved solids content (modified from Texas Water Commission, 1989).

Final Groundwater Availability Model for the Rustler Aquifer

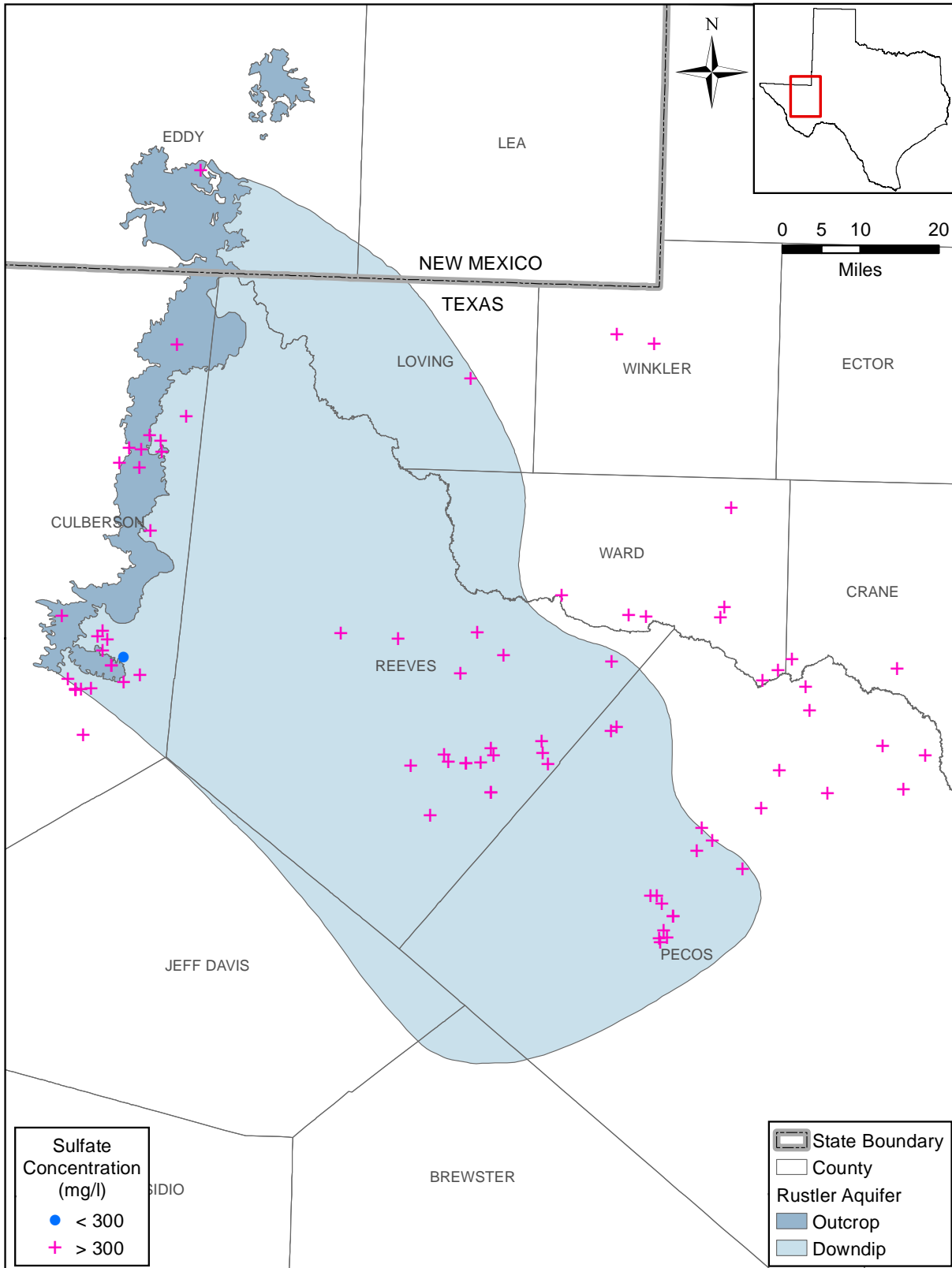

Figure 4.8.4 Sulfate concentration (in milligrams per liter) in the Rustler Formation (Bowman, 2010; TWDB, 2010c).

Final Groundwater Availability Model for the Rustler Aquifer

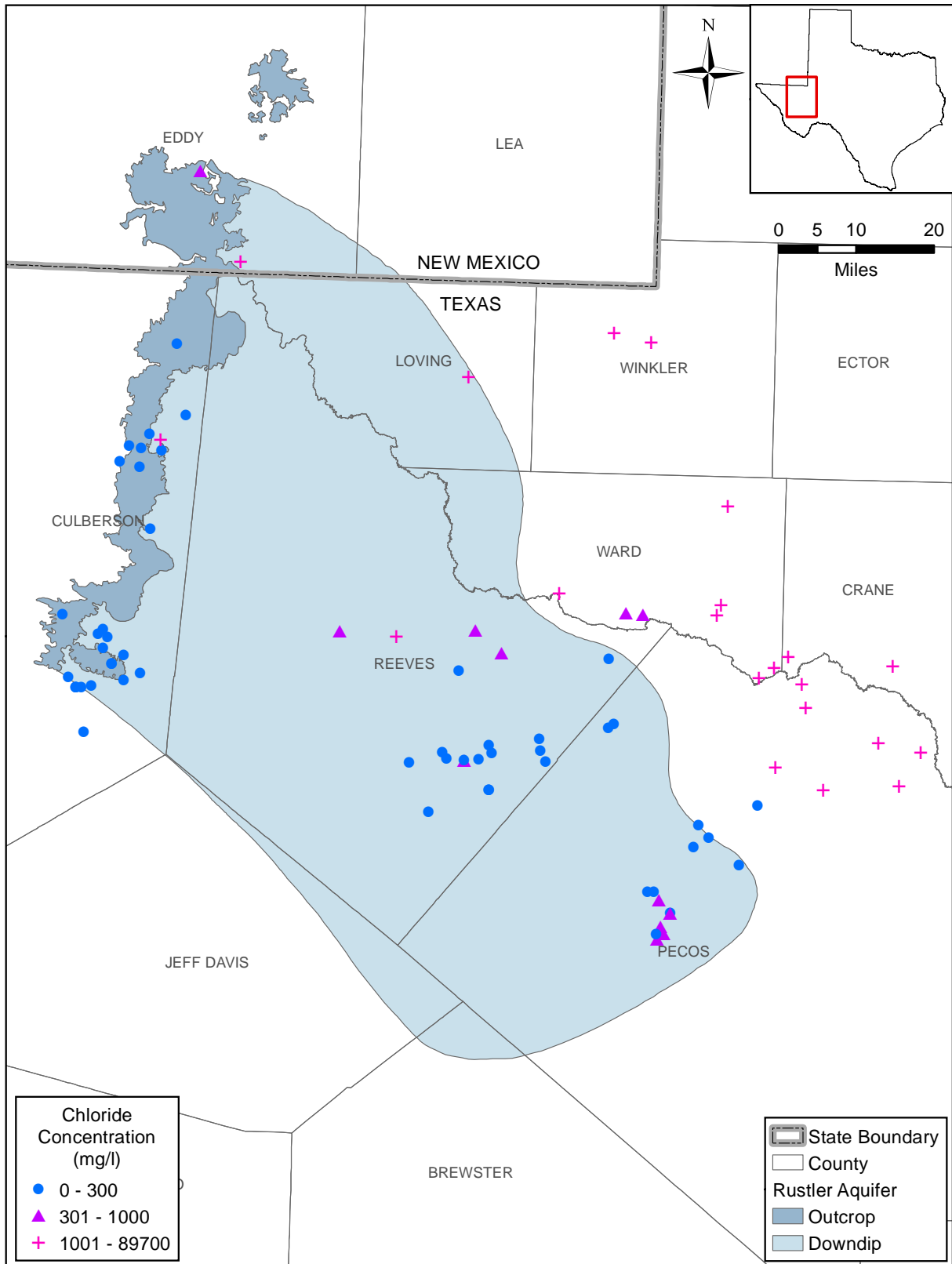

Figure 4.8.5 Chloride concentration (in milligrams per liter) in the Rustler Formation (Bowman, 2010; TWDB, 2010c).

Final Groundwater Availability Model for the Rustler Aquifer

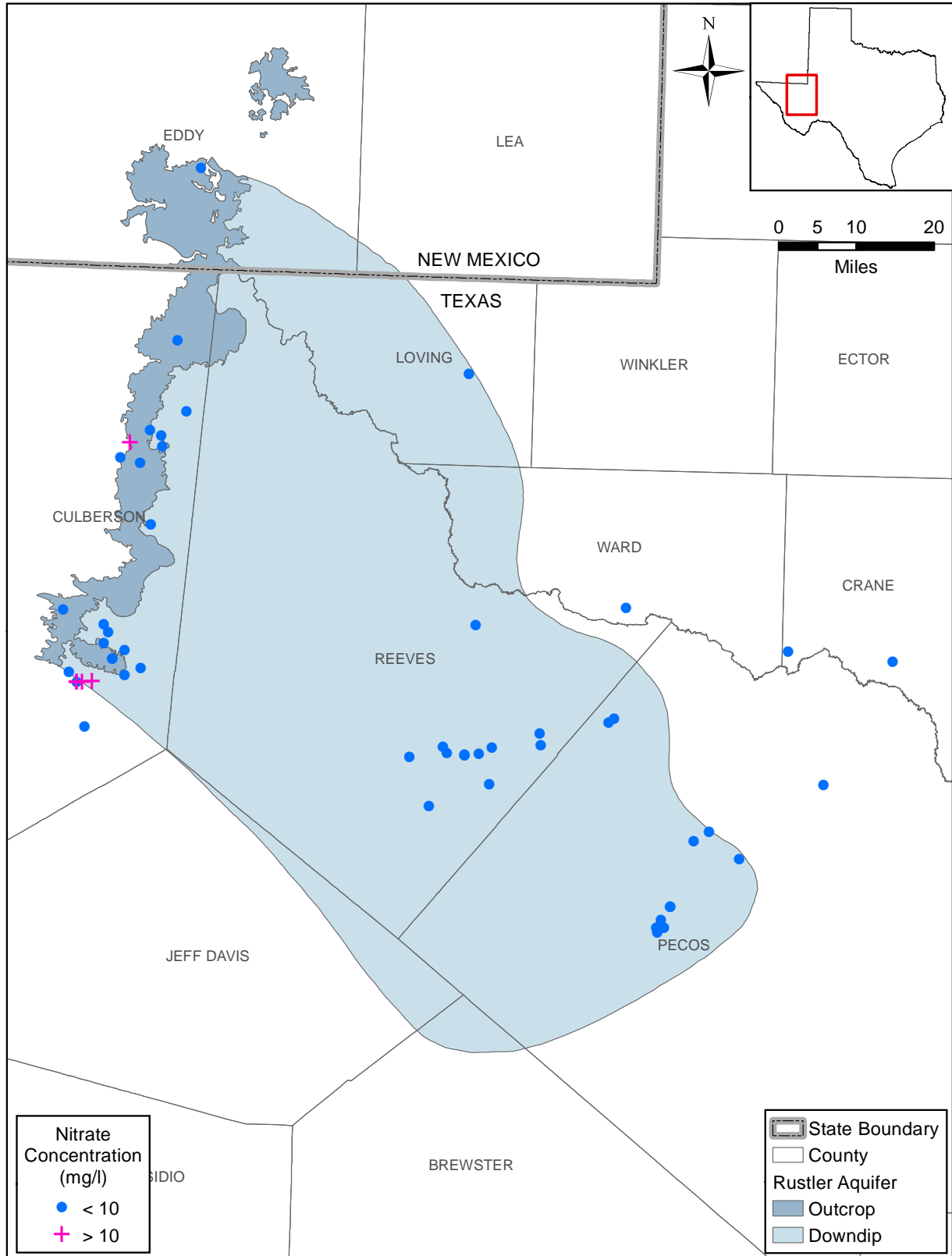

Figure 4.8.6 Nitrate concentration (in milligrams per liter as N) in the Rustler Formation (Bowman, 2010; TWDB, 2010c).

Final Groundwater Availability Model for the Rustler Aquifer

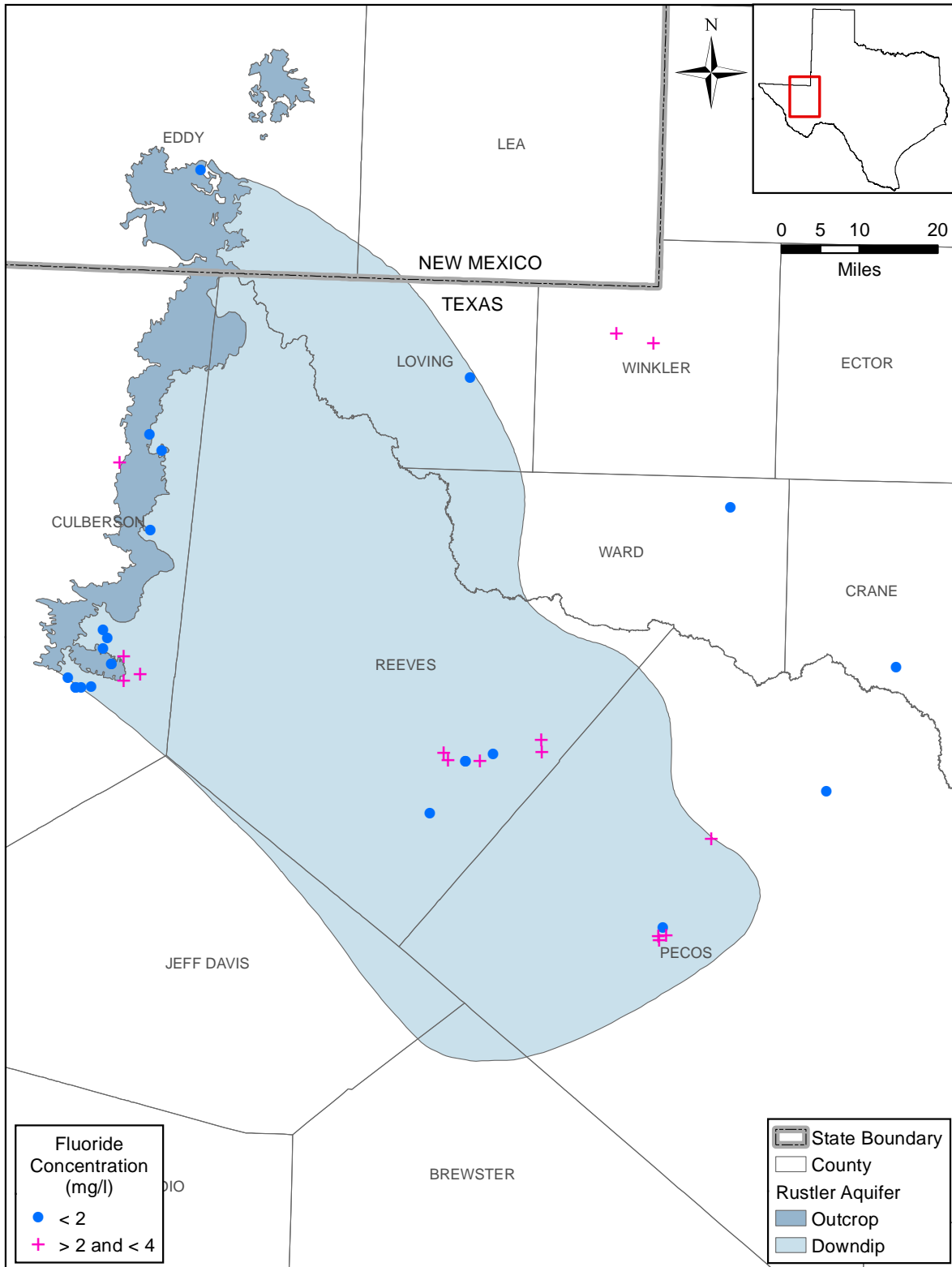

Figure 4.8.7 Fluoride concentration (in milligrams per liter) in the Rustler Formation (Bowman, 2010; TWDB, 2010c).

Final Groundwater Availability Model for the Rustler Aquifer

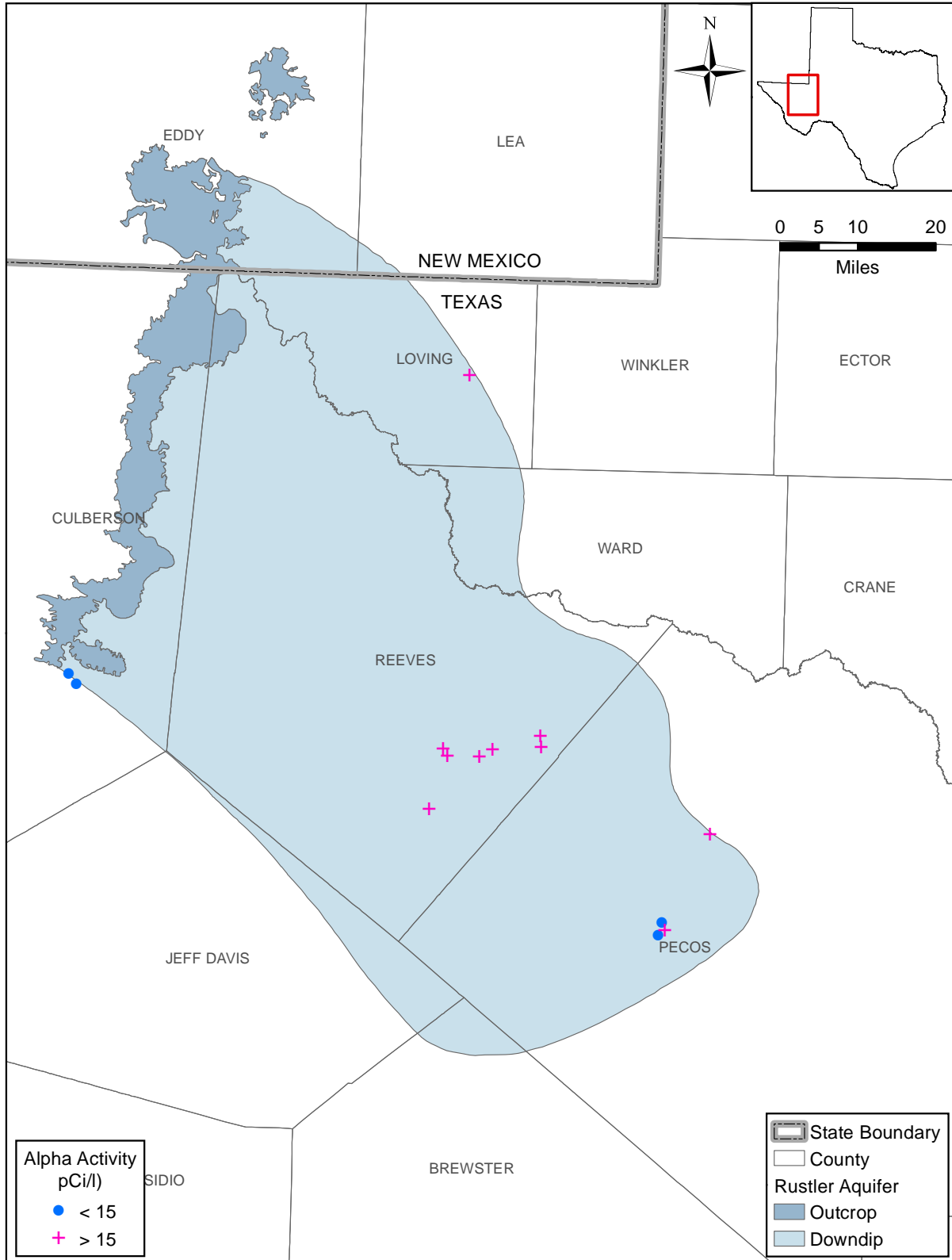

Figure 4.8.8 Alpha activity (in picocuries per liter) in the Rustler Formation (TWDB, 2010c).

Final Groundwater Availability Model for the Rustler Aquifer

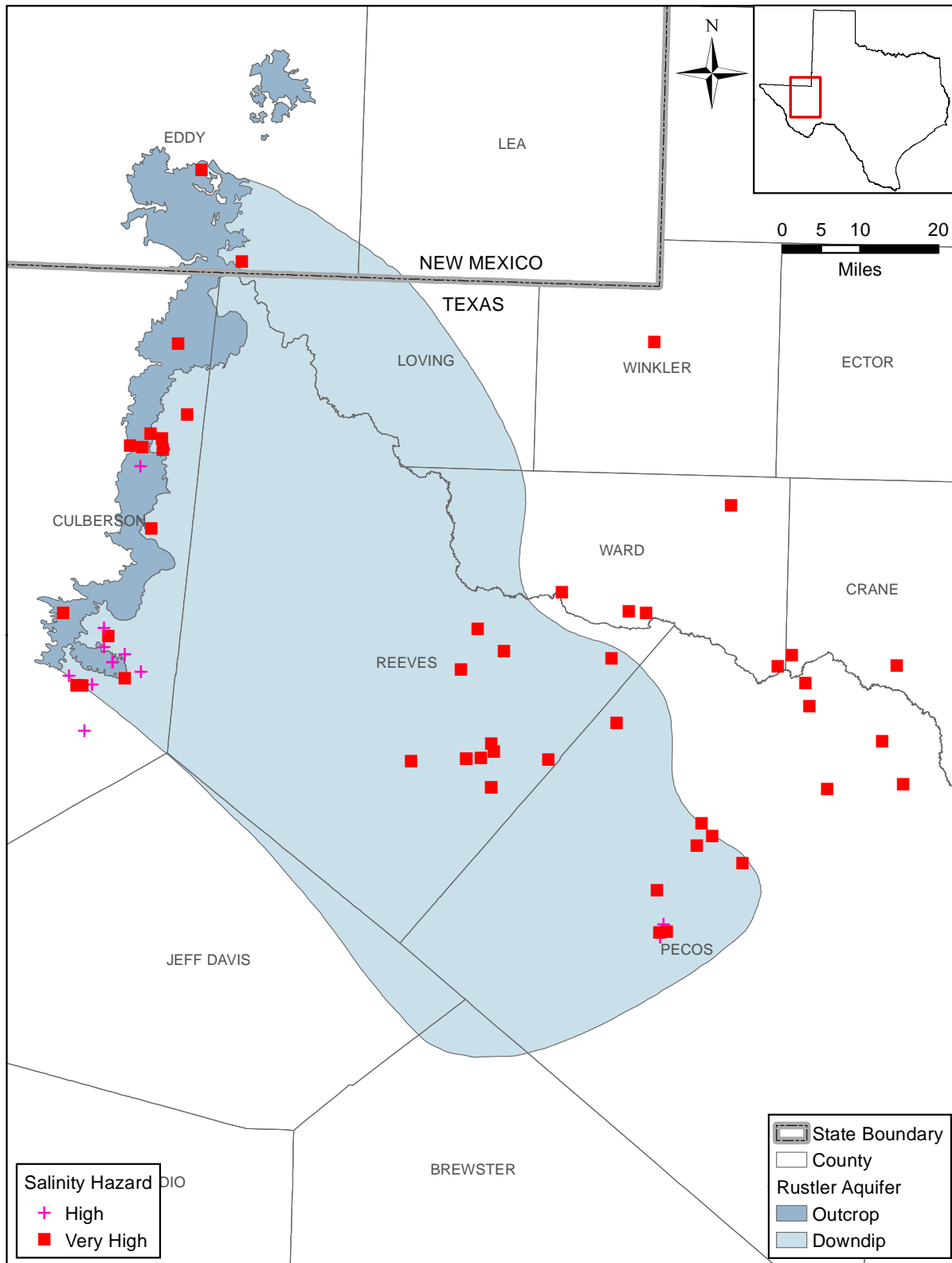

Figure 4.8.9 Salinity hazard in the Rustler Formation (Bowman, 2010; TWDB, 2010c).

Final Groundwater Availability Model for the Rustler Aquifer

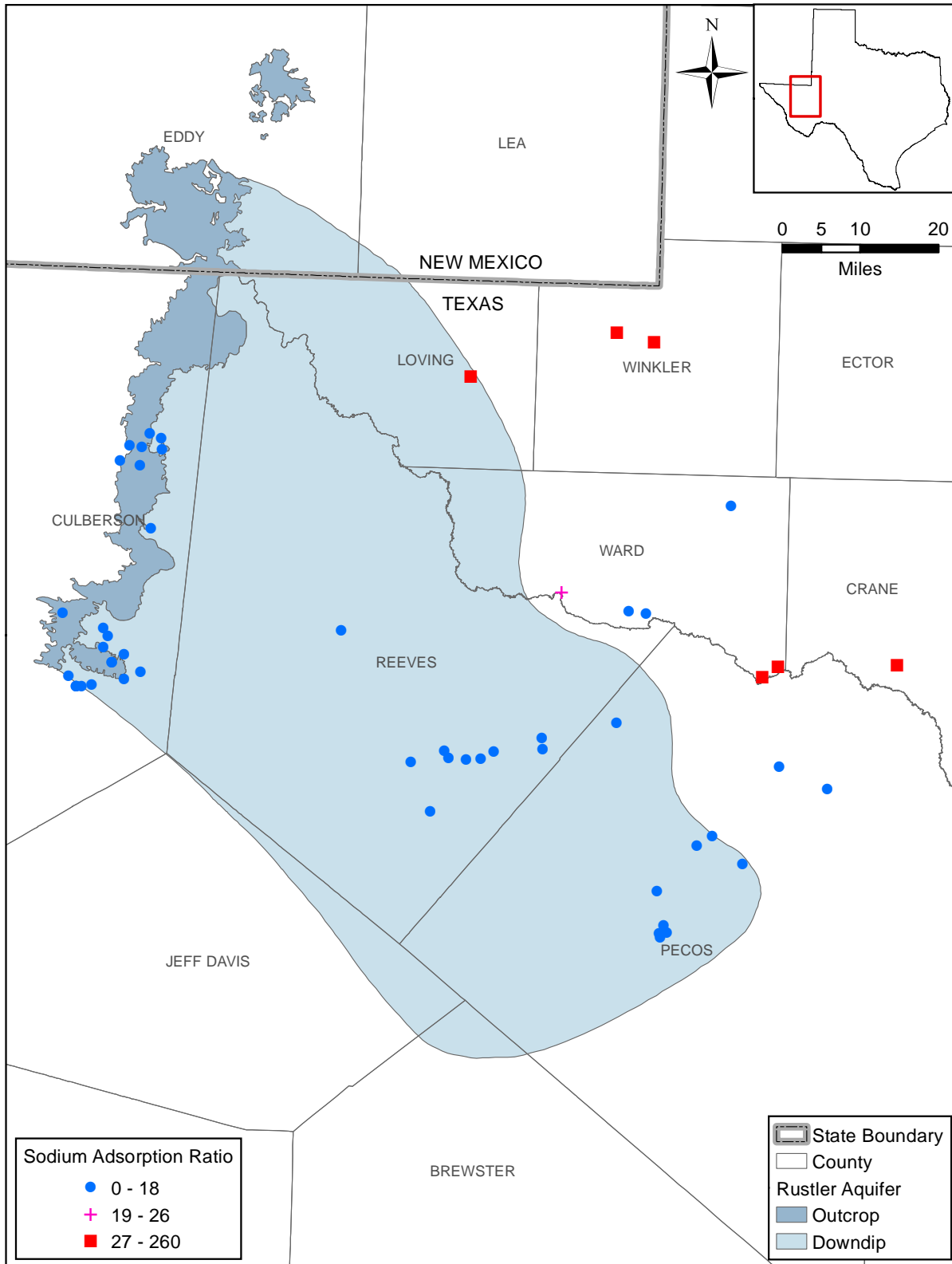

Figure 4.8.10 Sodium hazard in the Rustler Formation (TWDB, 2010c).

This page intentionally left blank.

5.0 Conceptual Model of Groundwater Flow in the Aquifer

The conceptual model of groundwater flow in the Rustler Aquifer is based on the hydrogeologic setting, described in Section 4.0. The conceptual model is a simplified representation of the hydrogeological features that govern groundwater flow in the aquifer. These include the hydrostratigraphy, structure, hydraulic properties, hydraulic boundaries, recharge and natural discharge, and anthropogenic stresses, such as pumping. Each of the elements of the conceptual model are summarized below. Because of the structural complexity of the Rustler Aquifer, the conceptualization of groundwater flow is also complex. A general lack of properties and flow constraints in the Texas portion of the aquifer, combined with the importance of fractures and potential faults as flow controls, make quantification of flow in the Rustler Aquifer difficult and makes any modeling study exploratory in nature.

The Rustler Aquifer is located in the Trans-Pecos region of west Texas. The boundaries of the Rustler Aquifer defined by the TWDB consist of the portion of the Rustler Formation containing groundwater having a total dissolved solids concentration of less than 5,000 milligrams per liter (Boghici and Van Broekhoven, 2001). The Permian-age Rustler Formation was deposited throughout the Delaware Basin, across the Central Basin Platform, and into the Midland Basin. In Texas, the Rustler Formation is locally subdivided into members that are regionally mappable. In Texas, the formation outcrops in eastern Culberson County where it has been mapped as six members, including (from youngest to oldest): the Forty-niner, the Magenta Dolomite, the Tamarisk, the Culebra Dolomite, a lower gypsum and mudstone, and a siltstone (Hentz and others, 1989). The lower two members appear to be equivalent to the Los Medoños Member of the formation in southeastern New Mexico as defined by Powers and Holt (1999).

East into Pecos County and along the terminal edges of the Delaware Basin to the south in the Glass and Apache mountains, the lithology and contact relationships within the Rustler Formation change. South into the Glass Mountains, the Salado and Rustler formations are considered facies equivalents to the Tessey Limestone, which has been postulated to provide a recharge source to the Rustler Aquifer in Pecos County (Armstrong and McMillion, 1961; Ogilbee and others, 1962; Richey and others, 1985; Boghici, 1997; Boghici and Van

Broekhoven, 2001; Bumgarner and others, 2012). The Rustler Formation continues and thins east of the Capitan Reef and onto the Central Basin Platform.

In the Delaware Basin and Central Basin Platform, the Rustler Formation unconformably overlies the Permian-age, halite-rich Salado Formation. Along the western margin of the Central Basin Platform, the Salado Formation is absent in some areas and the Rustler Formation overlies portions of the Permian-age limestone and dolomite deposits of the Capitan Reef Complex (Richey and others, 1985).

The Rustler Formation is overlain by several formations/aquifers in the Delaware Basin including the Permian-age Dewey Lake Formation, the Triassic-age Dockum Aquifer, the Cretaceous-age Edwards-Trinity (Plateau) Aquifer, and the Cenozoic-age Pecos Valley Aquifer. In northeastern Culberson County and northwestern Reeves County, the Dewey Lake Formation is absent and the Pecos Valley Aquifer directly overlies the Rustler Aquifer to the north (Ogilbee and others, 1962) and the Edwards-Trinity (Plateau) Aquifer overlies the Rustler Aquifer to the south (Knowles and Lang, 1947). The Rustler Formation is overlain by the Edwards-Trinity (Plateau) Aquifer in northeastern Pecos County and by the Dockum Aquifer in the rest of the county (Boghici, 1997).

The broader characteristics of the Rustler Aquifer structure are as follows: Basin and Range uplift to the west in mid- to late-Cenozoic time superimposed a general approximately one degree eastward regional dip in the Delaware Basin; localized synsedimentary subsidence in the eastern part of the Delaware Basin, as indicated by thickness changes of the Rustler Formation; and synsedimentary to post-sedimentary faulting along the eastern side of the Delaware Basin. The remaining elements of the complicated local structure are at least partially due to solution of underlying evaporites as well as Rustler Formation evaporites.

There are three main areas that show significant regional dip features; along the western side of the study area, including the outcrop area, the eastern side of the study area east of the Capitan Reef Complex Aquifer and on the Central Basin Platform, and along a central corridor exhibiting mostly north-south strike and eastward dip. A small part of the northern central corridor is an area showing synsedimentary subsidence.

There are three main regions showing post-depositional structural deformation: (1) a graben area trending north-northwest to south-southeast, (2) a west-central area showing deformation attributed mainly to dissolution of the Castile and Salado formations, as well as some Rustler Formation dissolution, and (3) a southern boundary area and faulting between Fort Stockton and Sierra Madera, which is located in the Glass Mountains. The graben mainly overlies the Delaware Basin-Central Basin Platform margin and the margin of the Capitan Reef Complex. The graben is complex. The boundary faults are defined mainly by narrow areas with major relative displacements (hundreds of feet). On both sides, the differential elevation across narrow areas indicates little likelihood that the Rustler Formation is hydraulically continuous across the graben. A west-central area where the Rustler Formation is disturbed generally parallels the Pecos River to just southeast of the town of Pecos and then extends southward.

The general structural character of the Rustler Formation, in addition to the aquifer data reviewed, provide a basis to subdivide the aquifer into hydrostructural domains that are significant for consideration of basin hydrogeology and construction of a groundwater availability model (GAM) for the aquifer (i.e., properties, boundaries). A review of the available literature and data reviewed in this report provides a basis to integrate the hydrostructural domains broadly into two general flow systems occurring in the Rustler Aquifer in Texas; a western flow system and a southern flow system as shown on Figure 5.0.1. There is potential that these two systems could be even further compartmentalized. Each of these are described below.

The western flow system originates in the Rustler Hills in Culberson County, Texas and in southern Eddy County, New Mexico. Recharge in this system originates in the Rustler Aquifer outcrop areas and it is conceptualized that most flow discharges either through springs or evapotranspiration with some flow down dip that likely eventually discharges to the Pecos River or via cross-formational flow to overlying aquifers. From the outcrop area, flow in the aquifer is generally eastward and northeastward (White, 1971; Boghici and Van Broekhoven, 2001), but lack of water-level data east, northeast, and southeast of the outcrop area limits this assumption of flow direction. Water-quality data in the Pecos Alluvium and Edwards-Trinity (Plateau) aquifers suggest that the Rustler Aquifer discharges into these two aquifers east of the Rustler Aquifer outcrop and in the Toyah Basin, which is located in central Reeves County (Rees and

Buckner, 1980; Texas Water Commission, 1989; Ashworth, 1990; Uliana and Sharp, 2001; Jones, 2001, 2004). The magnitude of this discharge is unknown, as is the amount of water that flows downdip into the aquifer subcrop. The absence of wells in hydrostructural subdomain 9 between the outcrop and the western fault defining this domain (see Figure 4.6.6) is the result of the great depth of the Rustler Aquifer in the Toyah Basin, the presence of prolific aquifers above the Rustler Aquifer, and a potentially low to very low transmissivity estimated for this portion of the aquifer. Richey and others (1985) suggest that groundwater in the Rustler Aquifer flows from the outcrop area to the Pecos River and its tributaries. It is likely that the majority of the water recharging the aquifer in the outcrop flows generally downdip and discharges into the Pecos River or overlying aquifers with little flow continuing deeply downdip.

Research by Uliana (2001), Uliana and Sharp (2001), and Sharp and others (2003) have suggested that there may be a regional carbonate flow system originating at the southern edge of the Rustler Hills (outcrop) funneling groundwater from Wildhorse Flat and the Apache Mountains through the Stocks Fault/Rounsaville Syncline system. Their research has also shown that many Edwards-Trinity (Plateau) spring systems (Balmorhea, Phantom, San Solomon) at the border of Jeff Davis and Culberson counties are fed by this regional flow system. The evidence is generally based upon water quality analyses using Cretaceous groundwater samples and surface runoff from the Davis Mountains. It has been postulated that the Rustler Aquifer could receive some regional component of groundwater flow paralleling the Stocks Fault/Rounsaville Syncline system that could flow north and northeast into the Toyah Basin. Some potential evidence for this can be found in the water quality map shown in Figure 4.8.3 of this report. This figure shows a less saline corridor of groundwater paralleling the Jeff Davis County line. Supporting data are not provided in the original figure and attempts to locate the source data through the TWDB were unsuccessful. For conceptual purposes, the potential for lateral inflow of groundwater across the southwestern model boundary from the southern end of the outcrop to the Jeff Davis-Brewster county line was considered.

A conceptual water balance of the western flow system can be estimated from information reviewed in Section 4.0. Assuming recharge in the outcrop is approximately 1 percent of precipitation as suggested by Gates and others (1980) equates to a recharge from direct precipitation of approximately 3,896 acre-feet per year. No estimates exist for lateral recharge

that may enter the Toyah Basin from the inferred regional aquifer system of Uliana and Sharp (2001). Permian-age sediments are buried beneath the Tertiary-age volcanics in Jeff Davis County (Beach and others, 2004) so it is assumed that this lateral flow component is likely small, but estimates are highly uncertain. Stream losses to the Pecos River were estimated to be approximately 1,107 acre-feet per year on average. Spring losses in the outcrop are estimated at 1,075 acre-feet per year. With these conceptual estimates of recharge and discharge at the surface, the amount of flow into the subsurface confined portions of the aquifer would be approximately 1,714 acre-feet per year minus evapotranspiration losses in the outcrop or Pecos River riparian zones.

The southern portion of the aquifer originates to the south of Pecos County and southeastern most Reeves County through postulated recharge in the Glass Mountains (see Figure 5.0.1). This recharge has been proposed to occur in the Tessey Limestone. It could also be originating in the Capitan Reef equivalent units and recharging the Rustler Aquifer in Pecos County through cross-formational flow. Both the total dissolved solids and Carbon-14 data available for the Rustler Aquifer support the concept of a flow path originating in the Glass Mountains and flowing northward to Ft. Stockton and Diamond Y Springs (see Section 4.8.2). Recharge to the aquifer could also be occurring through the Stocks Fault/Rounsaville Syncline System. The southern flow system in Pecos County has been demonstrated to be a prolific aquifer in the area of Belding and significant historical discharge has occurred in the vicinity of Diamond Y Springs, which at least in part must be attributed to the Rustler Aquifer. This flow system potentially extends into Reeves County from the south but little is known about the properties in this area. This area of the Rustler Formation is known to have a basal sandstone (Richey and others, 1985) and also has more carbonate facies than in the north (Eager, 1984). The portion of the flow system extending through Belding and into the Fort Stockton area sits above the Capitan Reef and appears to terminate in the area of Diamond Y Springs, which coincides with the southernmost extension of the deepest portions of the graben. Cross-formational flow has been postulated to be an important discharge mechanism for this portion of the aquifer (Veni, 1991; Boghici, 1997; Harden and others, 2011). The source of brackish water in the Edwards-Trinity (Plateau) Aquifer in western Pecos County is considered to be due to the mixing of groundwater in the Rustler Formation and the Edwards-Trinity (Plateau) Aquifer according to Boghici (1997) and Harden and others (2011). Whereas Harden and others (2011) saw a potential for diffuse

mixing based upon water-quality data, Boghici (1997) localized cross-formational flow from the Rustler Aquifer within the Belding Fault System. Veni (1991) hypothesized that discharge from the Capitan Reef Complex Aquifer into the Rustler Aquifer may occur north of the city of Fort Stockton in Pecos County at Diamond Y Springs. Through geochemical analyses, Boghici (1997) attributed flows at Diamond Y Springs to groundwater discharge from the Rustler Aquifer. Based upon a review of all of the data, there is significant evidence that cross-formational flow likely occurs in isolated regions between the Rustler Aquifer and the overlying Edwards-Trinity (Plateau) Aquifer. However, how much cross-formational flow occurs is less clear. The potential for flow between the Capitan Reef Complex and Rustler aquifers in predevelopment times is also unclear. Cross-formational flow between the Capitan Reef Complex and Rustler aquifers probably occurs in the same areas as cross-formational flow between the Rustler and Edwards-Trinity (Plateau) aquifers, that is, the area around Belding and potentially Diamond Y Springs.

A conceptual water balance of the southern flow system can be estimated from information reviewed in Section 4.0. Assuming direct aquifer recharge occurs in the Glass Mountains in the Tessey Limestone, it is believed that recharge as a percentage of precipitation could easily reach 10 percent of precipitation, which equates to approximately 2,600 acre-feet per year. Good estimates of lateral recharge from the proposed regional aquifer system of Uliana and Sharp (2001) are not available. For the purposes of conceptualization, this lateral recharge component is assumed to not exceed 1,000 acre-feet per year. This would provide a total potential recharge of approximately 3,600 acre-feet per year assuming that the Capitan Reef Complex Aquifer does not provide inflow to the Rustler Aquifer. The Rustler Aquifer contributes base discharge to the Diamond Y Springs system at a maximum potential value, based upon limited historical measurements, of approximately 1,049 acre-feet per year. With these conceptual estimates of recharge and discharge at the surface through subcrop springs, the amount of flow into the subsurface confined portions of the aquifer available for more diffuse cross-formational flow would be approximately 2,551 acre-feet per year. This could be compared to the estimate of Boghici (1997) for the Belding area of 3,800 acre-feet per year.

Recharge and natural discharge are poorly characterized for both aquifer flow systems but the western flow system recharge is considered to be better constrained due to the less structural

complexity within that system and the presence of an identifiable and connected recharge zone. The potential for groundwater discharge from evapotranspiration is considered much greater for the western flow system than for the southern flow system given the lower altitude and the greater potential for shallow flow systems to be intercepted. Discharge as a result of aquifer development has not been historically significant in terms of volume. However, given the high number of flowing wells that have been in the aquifer for many decades, total discharge through wells must be considered poorly characterized. The historical trend in pumping indicates a rapid and significant increase between the mid-1940s and mid-1950s and a much more gradual decrease between the mid-1960s and about 1979 (see Figure 4.7.4). Estimates of pumping from the aquifer indicate maximum rates of between 4,000 and 5,000 acre-feet per year from 1953 to 1968.

The schematic diagram in Figure 5.0.2 shows a west to east cross-section through the study area along with a conceptual block diagram illustrating aquifer contact relationships and sources and sinks to groundwater. The strategy for constructing the Rustler Aquifer GAM required two model layers. The lowermost active model layer represents the Rustler Aquifer. Except in its outcrop area, the Rustler Aquifer is overlain by some combination of the Dewey Lake Formation and the Dockum, Edwards-Trinity (Plateau), and Pecos Valley aquifers. The uppermost model layer typically represents the Dewey Lake Formation and Dockum Aquifer where present. Including these formations as a model layer provides vertical resistance and storage that exists (in most places) between the Rustler Aquifer and the overlying Edwards-Trinity (Plateau) and Pecos Valley aquifers. In addition, some Dewey Lake Formation outcrop is present in the region north of the county line between Culberson and Reeves counties, where the Pecos Valley Aquifer is not present and the Rustler Aquifer is confined.

The significant historical change in heads in the Pecos Valley Aquifer and the more moderate trends in the Edwards-Trinity (Plateau) Aquifer are modeled as a transient general-head boundary. There has not been significant pumping in the Triassic formations immediately above the Rustler Aquifer. The base of the Rustler Aquifer is underlain in most areas by the Salado or Castile formations. These formations are of very low transmissivity and are considered aquitards. They are represented as a no-flow boundary throughout the model domain. The assumption of a no-flow boundary at the base of the Rustler Aquifer could be in error in

Final Groundwater Availability Model for the Rustler Aquifer

hydrostructural domain 4B where significant evidence of cross-formational flow between the Capitan Reef Complex and Rustler aquifers exists and where Veni (1991) concluded that the Capitan Reef Complex Aquifer was a significant component of flow at Diamond Y Springs. As a result, Figure 5.0.2 shows a mixed no-flow and/or cross-formational flow boundary in the graben in southern Pecos County. Implementation of all model boundaries is discussed in Section 6.0.

Final Groundwater Availability Model for the Rustler Aquifer

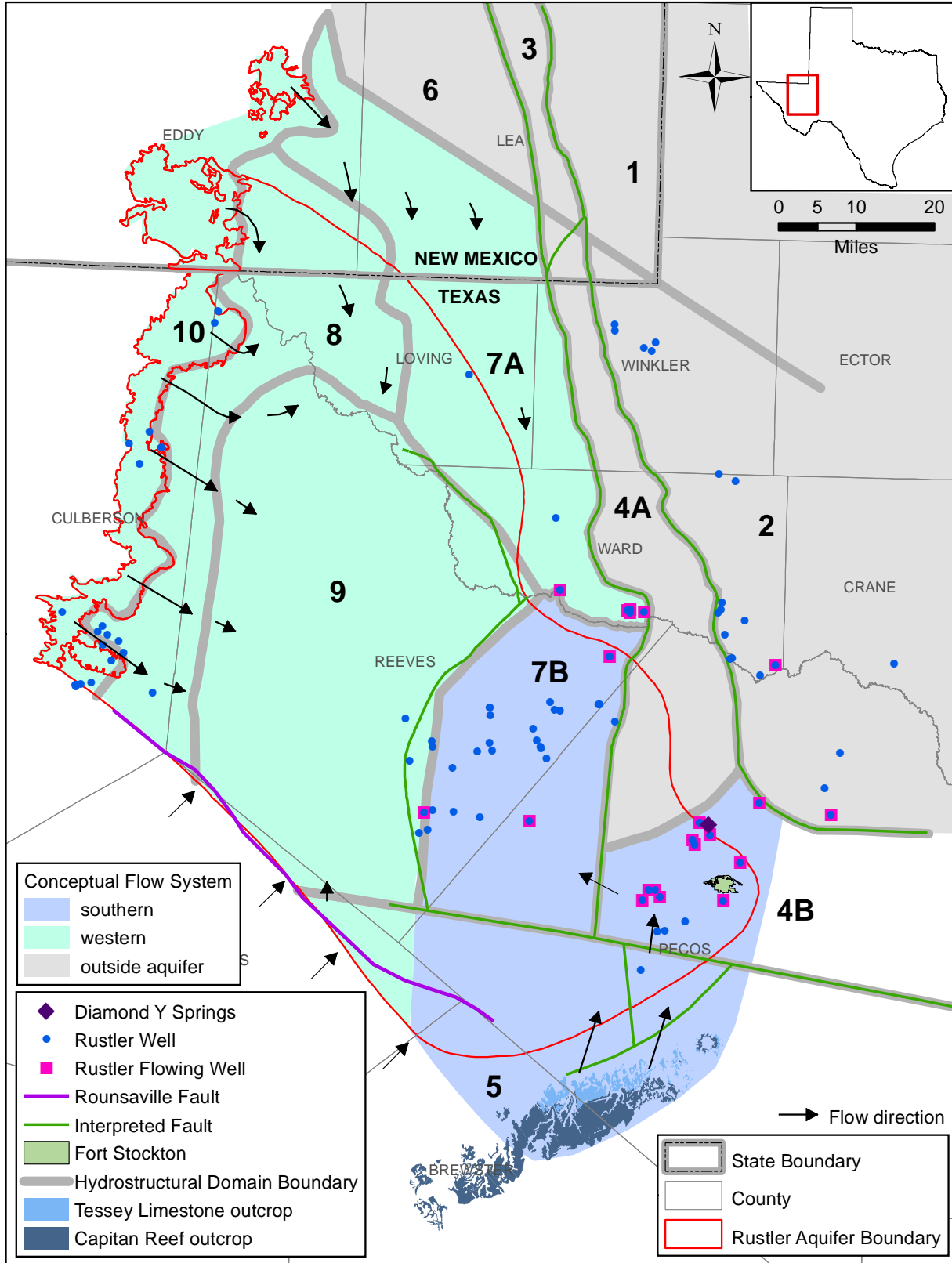
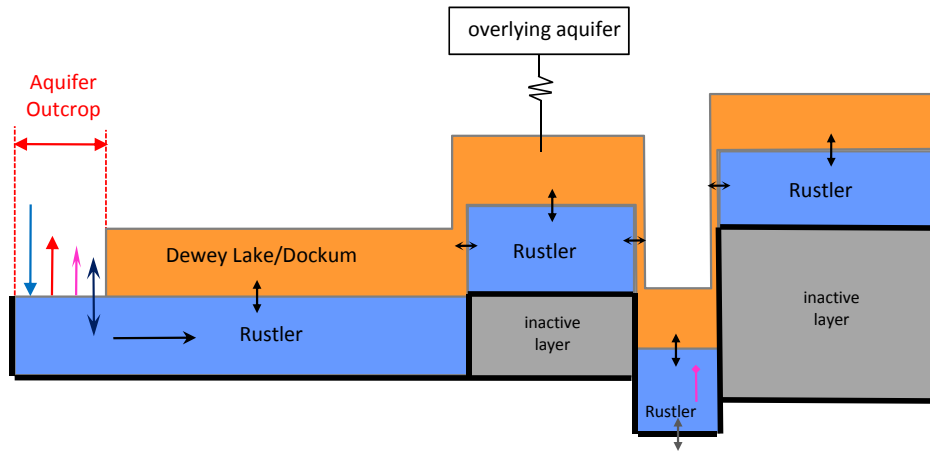
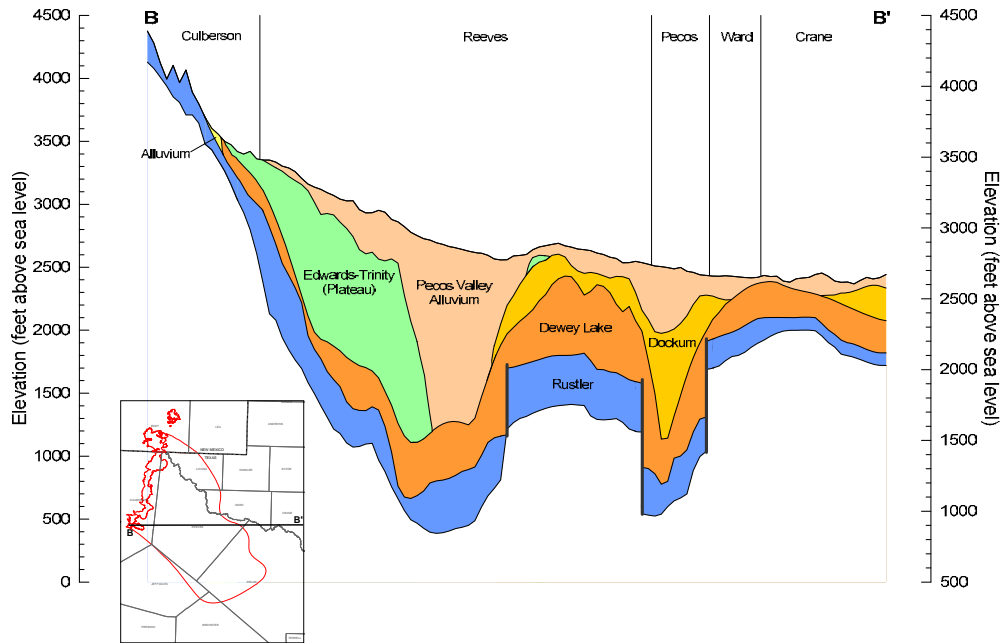

Figure 5.0.1 Conceptual diagram of the proposed flow systems in the Rustler Aquifer.

Final Groundwater Availability Model for the Rustler Aquifer



- General head boundary
- Recharge (precipitation)
- Discharge (evapotranspiration)
- Discharge (surface spring)
- Discharge (subcrop spring)
- ↔ Surface water-aquifer interaction
- Downdip flow
- ↔ Cross-formational flow
- ↔ Possible cross-formational flow
- ↔ Minor flow across fault areas
- No-flow boundary

Figure 5.0.2 Conceptual groundwater flow model (cross-sectional view) for the Rustler Aquifer GAM.

6.0 Model Design

Model design represents the process of translating the conceptual model for groundwater flow in the aquifer (Section 5.0) into a numerical representation which is generally described as the model. The conceptual model for flow defines the processes which define groundwater flow and, therefore, determines the attributes for the selected simulation code. In addition to selection of the appropriate code, model design includes definition of the model grid and layer structure, the model boundary conditions, and the model hydraulic parameters. Each of these elements of the model design and their implementation are described in this section.

6.1 Code and Processor

The code selected for the Rustler Aquifer GAM is MODFLOW-NWT (Niswonger and others, 2011). MODFLOW is a three-dimensional finite-difference groundwater flow code which is supported by enhanced boundary condition packages to handle recharge, evapotranspiration, streams (Prudic, 1988), springs, and reservoirs.

The benefits of using MODFLOW for the Rustler Aquifer GAM include: (1) MODFLOW incorporates the necessary physics represented in the conceptual model for flow described in Section 5.0 of this report, (2) MODFLOW is the most widely accepted groundwater flow code in use today, (3) MODFLOW was written and is supported by the United States Geological Survey and is public domain, (4) MODFLOW is well documented (McDonald and Harbaugh, 1988; Harbaugh and McDonald, 1996; Harbaugh and others, 2000, Harbaugh, 2005; Niswonger and others, 2011), (5) MODFLOW has a large user group, and (6) there are numerous graphical user interface programs written for use with MODFLOW.

The MODFLOW datasets were developed to be compatible with Groundwater Vistas for Windows Version 6 (Rumbaugh and Rumbaugh, 2011). The model was executed on x86 compatible computers equipped with the Windows 7 operating system. MODFLOW is not typically a memory-intensive application in its executable form. However, if any preprocessor (such as Groundwater Vistas) is used for a model of this size and complexity, at least 1GB of RAM is recommended.

Final Groundwater Availability Model for the Rustler Aquifer

This page intentionally left blank.

6.2 Model Layers and Grid

MODFLOW requires a rectilinear grid. Typically, one axis of the model grid is aligned parallel to the primary direction of flow. Due to its separate flow domains, the Rustler Aquifer has no primary flow direction. For simplicity, the Rustler Aquifer GAM grid was aligned with the primary directions in the GAM projected coordinate system. The grid cells are quarter-mile by quarter-mile squares throughout the model domain. The model grid origin (lower left) is located at GAM coordinates 19,438,000 feet north and 3,550,550 feet east with the x-axis oriented east-west. The model has 466 columns and 526 rows for a total of 245,116 grid cells per layer. Not all of these grid cells are active in the model. Because of the small size of the model grid cells relative to the total area of the modeled region, there is no effective way to show the model grid resolution across the entire active region. Instead, Figure 6.2.1 shows the active model area for the Rustler Aquifer GAM and includes an inset with an enlargement of Loving County to demonstrate the model grid at the county scale. After clipping the layers to their proper dimensions, model layers 1 and 2 have 109,167 and 117,073 active grid cells, respectively. The total number of active grid cells in the model is 226,240. As discussed in Sections 4.2 and 4.6, the active model area does not include hydrostructural domains 1, 2, 3, and 6. In addition, only the lower portion of subdomain 4A located south of the Pecos River is included in the active model area.

The Rustler Aquifer GAM is divided into two model layers. The Rustler Aquifer, the extent of which is discussed in Section 4.2.1, is represented by model layer 2. Layer 1 represents the Dewey Lake Formation and Dockum Aquifer. This additional layer allows for simulation of cross-formational flow between the overlying Edwards-Trinity (Plateau) and Pecos Valley aquifers and the underlying Rustler Aquifer through the Dewey Lake and Dockum formations. It should be noted, however, that the inclusion of this upper layer is intended only to provide a rudimentary representation of the overlying aquifers through explicit incorporation of the Dewey Lake and Dockum formations and implicit incorporation of the formations younger than the Dewey Lake and Dockum. The aquifers above the Dewey Lake and Dockum formations, specifically the Edwards-Trinity (Plateau) and Pecos Valley aquifers, are the dominant aquifers in the region but are only handled as boundary conditions in this model. Specifically, all the

recharge, pumping, and surface water interaction that occur within these aquifers are aggregated into the general-head boundary condition applied to the majority of layer 1 cells.

In the outcrop of the Rustler Aquifer, the upper boundary of the model is defined by ground surface as calculated by the 30-meter digital elevation map averaged to the grid cells. The top of layer 1 is defined by the top of the Dewey Lake and Dockum formations. The base of layer 1 is defined as the top of the Rustler Aquifer (Figure 4.2.3). The base of layer 2 is defined as the base of the Rustler Aquifer (Figure 4.2.4). A minimum layer thickness of 100 feet was enforced whereby layer 2 basal elevations were lowered if necessary to maintain the minimum thickness. Both model layers are simulated as confined to improve model convergence. Only a small portion of the model domain outcrops and has the potential to be unconfined. Changes in transmissivity resulting from changes in saturated thickness in the outcrop are expected to be minimal. Consequently, simulating the layers as confined is expected to have minimal negative impact on the accuracy of the model results.

Final Groundwater Availability Model for the Rustler Aquifer

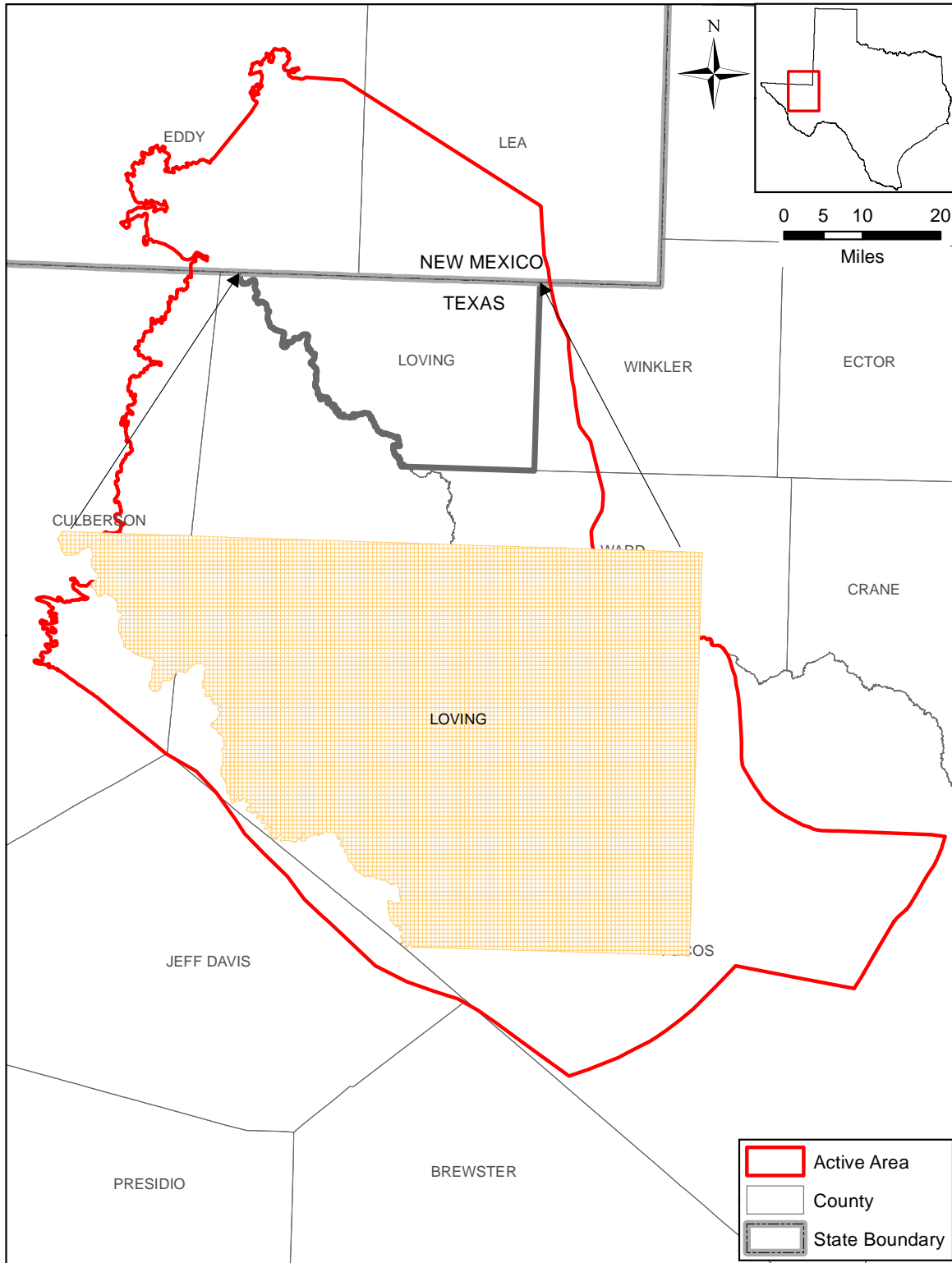

Figure 6.2.1 Active model area and model grid at the county scale for the Rustler Aquifer GAM.

Final Groundwater Availability Model for the Rustler Aquifer

This page intentionally left blank.

6.3 Boundary Condition Implementation

A boundary condition can be defined as a constraint put on the active model grid to characterize the interaction between the active domain and the surrounding environment. There are generally three types of boundary conditions: specified head (First Type or Dirichlet), specified flow (Second Type or Neumann), and head-dependent flow (Third Type or Cauchy). The no-flow boundary condition is a special case of the specified flow boundary condition.

Boundaries can be either time independent or time dependent. An example of a time-dependent boundary is a pumping flow boundary (e.g., grid cell with a well) or a reservoir stage elevation. Because many boundaries require time-dependent (transient) specification, the stress periods used by MODFLOW must be specified. A stress period in MODFLOW defines the time period over which boundary and model stresses remain constant. Each stress period may have a number of computational time steps, which are some fraction of the stress period. For the transient model, yearly stress periods were used from 1919 through 2008. Therefore, transient boundaries in the model cannot change over a period of less than 1 year.

Boundaries requiring specification include: lateral and vertical boundaries for each layer, surface-water boundaries, recharge boundaries, and discharge boundaries, including evapotranspiration and pumping. Specified flow (no-flow, Second Type) boundary conditions were assigned to the lateral and lower boundaries and head-dependent flow boundaries (Third Type) were assigned to the top model layer. Surface-water boundaries, including streams, springs (drains), and evapotranspiration (ET), are head-dependent flow boundaries (Third Type). Recharge is a specified flow boundary (Second Type). Pumping discharge is a specified flow boundary (Second Type). Flowing wells (drains) are head-dependent flow boundaries.

The lateral extents and boundary zones for the Rustler Aquifer are depicted in Figure 6.3.1. Figures 6.3.2 and 6.3.3 show the active and inactive grid areas along with the model boundary condition types for model layers 1 and 2, respectively. In Figures 6.3.2 and 6.3.3, areas exterior to the active model boundary are colored grey to denote being inactive. Implementation of the boundary conditions for the Rustler Aquifer GAM is described below. Unless otherwise specified below, the boundary between the active and inactive cells is a no-flow boundary.

6.3.1 Lateral Model Boundaries

The lateral model boundaries have been developed to comply with structural or otherwise natural hydrologic boundaries to the best degree possible as defined by the extent of the Rustler Aquifer and the extents of the hydrostructural domains discussed in Sections 4.2.3, 4.6, and 5.0. Beyond the extent of the Rustler Aquifer outline or the faults defining the hydrostructural domains, grid cells were set as inactive, creating a no-flow boundary along the intersection of the active and inactive cells. For layer 1, a lateral no-flow boundary was also set at the physical extent of the Rustler Aquifer subcrop so that layer 1 cells were inactive where the Rustler Aquifer outcrop exists. For layer 2, the lateral extent was identical to those of layer 1 apart from where the lateral boundary was extended to include the outcrop of the Rustler Aquifer.

In Figure 6.3.1, the boundaries are represented as a series of segments lettered A through H. Note that the white area in the figure between the Rustler Aquifer outline and the active model boundary represents parts of the model outside of the boundaries of the Rustler Aquifer as defined by the TWDB based upon water quality considerations. The outcrop makes up the westernmost boundary (A-Outcrop) and is the updip limit of the Rustler Formation. This is a natural lateral no-flow boundary. The northeastern extent of the active model area (B-Halite Line) is defined by the halite line north of which the permeability of the Rustler Formation is confirmed to be very low. Groundwater flow runs perpendicular to the halite line and this boundary is assumed to be adequately represented by a no-flow boundary condition. The eastern boundaries of the active area (boundary zones C and E) are described by faults whereby the Rustler Formation within the active model domain is completely disconnected from the portions of the formation lying to the east. These faults are represented by no-flow boundaries in the model and physically represent the eastern edge of the graben. The portion of the eastern boundary coinciding with the Pecos River (D-Pecos River) is considered a regional groundwater flow divide and is represented by a no-flow boundary. The southeastern extent of the active model area (F-Boundary) is defined by the 2,000-foot structure contour line of the top of the Rustler Formation. This portion of the formation coincides with faulting that delineates the Sheffield Channel. Little is known about the aquifer as it extends east in this area and this boundary is considered poorly defined. It is treated as a distance boundary to the developed portions of the aquifer and is implemented as a no-flow boundary.

The exceptions to the no-flow lateral boundary condition within the Rustler Aquifer (layer 2) occur along the southern boundary where water is assumed to recharge the Rustler Aquifer from the Glass Mountains (G-Boundary) and the southwestern boundary where flow from the Davis Mountains could occur (Sharp, 2001) through lateral flow through the Cretaceous and Permian (Rustler) systems or through vertical connection through the Rounsaville Fault System (H-Boundary). While these boundaries are technically lateral boundary conditions, for hydrogeologic consistency, they are discussed below in Section 6.3.4.

6.3.2 Vertical Boundaries

A no-flow boundary was used at the bottom of layer 2 (the Rustler Aquifer). Although the underlying Capitan Reef Complex Aquifer likely has some hydraulic connection to the Rustler Aquifer, the degree of this connection is unknown. And, while pre-development heads within the Capitan Reef Complex Aquifer may be inferred from Hiss (1975), modern water levels and hydraulic properties of the formation are largely unknown. Because of the potential dominating effect of the Capitan Reef Complex Aquifer as a boundary condition coupled with the assessment that existing data poorly constrain the relationship between it and the Rustler Aquifer, adequate knowledge to meaningfully implement the Capitan Reef Complex Aquifer in the model was lacking. Therefore, the hydraulic connection between the Rustler and Capitan Reef Complex aquifers was not included in the model. This does not mean that this hydrologic connection could not be important (see Section 10 for further discussion of these limitations).

The model has a head-dependent flow boundary (Third Type) within layer 1 (Edwards-Trinity (Plateau) and Pecos Valley aquifers). From the perspective of the Rustler Aquifer, this boundary represents the flow coming from or discharging to the Edwards-Trinity (Plateau) and Pecos Valley aquifers through the Dewey Lake and Dockum formations. The general-head boundary package simulates a head-dependent flow boundary condition and requires the hydraulic head and hydraulic conductance as input parameters. The conductance in the general-head boundary package represents the composite vertical conductance of the Edwards-Trinity (Plateau) and Pecos Valley aquifers and the Dewey Lake and Dockum formations. The difference between the heads in the Edwards-Trinity (Plateau) and Pecos Valley aquifers and those in the Dewey Lake and Dockum formations sets the gradient that, along with this composite conductivity, governs the amount of flow between the aquifers. The composite vertical conductance was calculated

based on the vertical hydraulic conductivity of the Dewey Lake and Dockum formations and the upper half of that unit's thickness. This approximation is based on the assumption that the Dewey Lake and Dockum formations have a significantly lower vertical hydraulic conductivity than the overlying Edwards-Trinity (Plateau) and Pecos Valley aquifers and, therefore, provide the primary resistance to vertical flow between the Edwards-Trinity (Plateau) and Pecos Valley aquifers and the Rustler Aquifer. The Dockum GAM (Ewing and others, 2008) indicates that the vertical hydraulic conductivities of the Dockum Aquifer are on the order of 10^{-3} to 10^{-4} feet per day. The Dewey Lake Formation is assumed to be of comparable or lower conductivity. A vertical hydraulic conductivity value of 10^{-3} feet per day was chosen as the initial estimate for the calculation of the general-head boundary conductances.

For the steady-state model period, some pre-development water-level measurements are available in the TWDB groundwater database for portions of the Edwards-Trinity (Plateau) and Pecos Valley aquifers. Those data were interpolated using kriging to obtain head contours. In the remaining areas, pre-development heads were available from the Edwards-Trinity (Plateau) and Pecos Valley aquifers GAM (Anaya and Jones, 2009). Figure 6.3.4 shows the contoured TWDB groundwater data and the data from the Edwards-Trinity (Plateau) and Pecos Valley aquifers GAM used to develop the general-head boundaries for layer 1. In the small area neighboring the Rustler Aquifer outcrop where neither water-level measurements nor simulated heads were available, no general-head boundary condition was implemented. Because this area is relatively small and lies between the general-head boundaries and the recharge boundary condition within the Rustler Aquifer outcrop, this implementation is considered adequate. The resulting interpolated pre-development head surface for layer 1 is shown in Figure 6.3.5.

In the transient model, the heads in the general-head boundary of layer 1 were adjusted to account for water-level changes within the Edwards-Trinity (Plateau) and Pecos Valley aquifers over time resulting from development within those aquifers. Because the temporal and spatial extent of measured water levels within the Edwards-Trinity (Plateau) and Pecos Valley aquifers is incomplete, the simulated drawdown from the Edwards-Trinity (Plateau) and Pecos Valley aquifers GAM (Anaya and Jones, 2009) was used. While more recent versions of the model exist, the original GAM (Anaya and Jones, 2009) appeared to match the observed water levels in the area of interest best. The simulated drawdown from the Edwards-Trinity (Plateau) and Pecos

Valley aquifers GAM (yearly cell-averages from 1919 through 2008) was selected at 282 control points. These drawdown values were then interpolated at each grid block within the Rustler Aquifer model over the entire coincident portion of the Edwards-Trinity (Plateau) and Pecos Valley aquifers GAM domain using kriging. The interpolated drawdown values were then subtracted from the steady-state general-head boundary heads to calculate the general-head boundary heads for each stress period in the transient model. The majority of the simulated drawdown in the Edwards-Trinity (Plateau) and Pecos Valley aquifers GAM occurs in western Pecos County and southeastern Reeves County centered primarily over hydrostructural subdomain 7B. A comparison of the heads developed for the general-head boundary to measured water levels indicated that the Edwards-Trinity (Plateau) and Pecos Valley aquifers GAM overestimates drawdown in the majority of wells in this region. To better match the observed data, the simulated drawdown in the Edwards-Trinity (Plateau) and Pecos Valley aquifers GAM was reduced by a factor of two before generating the final transient general-head boundary heads. The misfit and reduction in drawdown at two example wells are shown in Figure 6.3.6.

6.3.3 Surface Water Implementation

Surface water along the Pecos River acts as a head-dependent flow (Third Type) boundary condition for the top boundary of the active model grid cells in layer 2 (the Rustler Aquifer) and a small portion of layer 1 (where neither the Dewey Lake nor Dockum formations are present). Because only a short section of the Pecos River crosses the Rustler Aquifer outcrop, the general-head boundary package was deemed sufficient to represent the river. The general-head boundary package allows for stream-related discharge during gaining conditions and for stream-related recharge during losing conditions. The general-head boundary head was set to the minimum digital elevation model value in a given grid cell and the conductance was assumed to be uniformly 100 feet squared per day within each quarter-mile grid cell. These Pecos River cells are demarcated in the MODFLOW general-head boundary package with the text “Pecos” while the general-head boundary cells are tagged with the text “ETPwl” where they represent the water levels in the Edwards-Trinity (Plateau) and Pecos Valley aquifers. Because any temporal variations in the stage of the Pecos River are considered minor with respect to the impact of the Pecos River on the groundwater flow of the Rustler Aquifer, the implementation of the Pecos

River as general-head boundary cells is considered adequate for any predictive simulations under different climatic scenarios.

Although one reservoir (Red Bluff Reservoir) is located within the model area, it sits on the units overlying the Rustler Aquifer and does not directly contact the Rustler Aquifer. However, the aquifer and reservoir are hydraulically connected as described in Section 4.5.3. The impact of the reservoir on the Rustler Aquifer is assumed to be adequately simulated by the general-head boundary conditions representing the Edwards-Trinity (Plateau) and Pecos Valley aquifers and the Pecos River located in that portion of layer 1.

Spring discharge records were reviewed for application in the Rustler Aquifer GAM as drain boundary conditions (Type 3). Table 4.5.2 summarizes the documented springs in the model domain. It is hypothesized in the conceptual model that the cumulative effect of the springs, which discharge individually at smaller rates, may be a significant form of discharge for the aquifer. Therefore, an attempt to include all documented springs in the model domain was made. In addition, Diamond Y Springs has had significant measured flows over the historical record. The average digital elevation model elevation occurring in a drain cell was used to set the drain elevations.

6.3.4 Implementation of Recharge and Evapotranspiration

In Section 5.0, two potential and different recharge boundaries for the Rustler Aquifer are identified. The more typical boundary is the outcrop recharge which occurs in Culberson County. It has also been postulated that recharge to the Rustler Aquifer may occur through the Tessey Limestone (facies equivalent to the Rustler and Salado formations) in the Glass Mountains and through cross-formational flow occurring along the Jeff Davis County boundary either from the northwest or from the south into the Toyah Basin.

Because an evaluation of groundwater availability is largely dependent upon recharge (Freeze, 1971), it is an important model input parameter warranting careful examination and meaningful implementation. Ideally, recharge is constrained in magnitude through some knowledge regarding the natural discharge volumes of the aquifer. As discussed in Section 5.0, there are no hard numbers on total natural aquifer discharge to use. No estimates of recharge are available for the outcrop in Culberson County. Boghici (1997) estimated that approximately 260 acre-feet

per year may discharge from Diamond Y Springs and approximately 3,700 acre-feet per year may discharge in the Belding-Coyanosa region in Pecos County.

In typical model applications, recharge is either homogeneously defined as a percentage of the yearly average precipitation or calibrated as an unknown parameter. Unfortunately, recharge and hydraulic conductivity can be correlated parameters preventing independent estimation when using only head data constraints. Another compounding problem is that recharge is a complex function of precipitation rate and volume, soil type, water level and soil moisture, topography, and evapotranspiration (Freeze, 1969). Precipitation, evapotranspiration, water-table elevation, and soil moisture are spatially and temporally variable. Soil type, geology, and topography are spatially variable. For the Rustler Aquifer GAM, specification of recharge for steady-state conditions and for transient conditions from 1919 through 2008 is necessary. Reliable estimates of recharge at the watershed scale, or the regional model scale (thousands of square miles for the GAMs) do not currently exist.

According to the discussion of recharge in the Rustler Aquifer outcrop outlined in Section 4.4, recharge is assumed to equal one percent of the 30-year average annual precipitation (1971 through 2000, from the PRISM dataset). The resulting average recharge for the outcrop is 0.146 inches per year. This approach is consistent with Gates and others (1980) and generally consistent with the analysis presented in Beach and others (2004).

The average recharge rate was redistributed spatially based on topography. A recharge elevation model was built using “local” topography, which was calculated as the ratio between the average digital elevation model values for a given grid cell and the outcrop as a whole. Recharge rates were weighted as a power function of the local topography and normalized to conserve the total recharge volume equivalent to the average of 0.146 inches per year, if applied uniformly. The power function coefficient was adjusted until the maximum recharge rate was reasonable (approximately 0.3 inches per year). Figure 6.3.7 depicts the steady-state recharge distribution using this recharge elevation model. This distribution of recharge rates was also assumed to apply to each year during the transient simulation period and no temporal variation in recharge was applied.

For the flow emanating from the Glass Mountains, the recharge entering the Tessey Limestone was estimated to range from approximately 200 acre-feet per year to approximately 2,600 acre-feet per year depending on the percentage of precipitation assumed to recharge the formation (see Table 4.4.3). This inflow was implemented using the well package with an injection well placed in each of the cells along the G-Boundary and an initial total flow of 1,800 acre-feet per year. This rate was later altered during calibration. The inflows were transmissivity weighted to account for both the formation thickness and depth (considering depth decay) for the grid cells along the boundary. For the inflow coming from the Davis Mountains (H-Boundary), a similar inflow boundary condition was implemented using the well package; however, the inflow rate was initially set to zero and later altered during calibration. These inflow rates are considered to be long-term average rates with any temporal variability being dampened by the distance between the boundary condition and the developed portions of the Rustler Aquifer. The calibrated inflow rates are therefore considered representative for use in predictive simulations of the Rustler Aquifer.

For the simulation of evapotranspiration, the evapotranspiration package was used for riparian cells neighboring streams in the outcrop. The Enhanced Reach File 1 coverage (Alexander and others, 1999) was used to represent the streams so evapotranspiration was applied along ephemeral streams as well as the perennial Pecos River. Parameters needed in the evapotranspiration package include maximum evapotranspiration rate, extinction depth, and elevation of evapotranspiration surface. Following Scanlon and others (2005), the maximum evapotranspiration rate can be estimated by the product of potential evapotranspiration and crop coefficient. The vegetation rooting depth was used as the extinction depth, and the elevation of the top of the model served as the elevation of the evapotranspiration surface. Both vegetation coefficient and rooting depth were adopted from the database in Scanlon and others (2005) according to the land type. The location of the evapotranspiration cells are shown in Figure 6.3.3. Maximum evapotranspiration rates range from 39 to 45 inches per year in the riparian cells.

6.3.5 Implementation of Pumping Discharge

A number of wells drilled into the Rustler Aquifer were artesian and flowed when initially completed. Although these wells were likely not pumped while they still flowed, the flow rates

amount to a significant discharge volume of groundwater from the Rustler Aquifer. To account for this discharge, drain cells were implemented in the model at the known flowing well locations. These flowing wells are differentiated from the drain cells in the MODFLOW drain package from the springs also included in the package by preceding the well number with the characters “fw” for flowing well while the drain cells representing actual springs are differentiated by the use of “spring” in the name. The drain elevation was set to the average land surface elevation for a given grid cell. The drain conductance was uniformly set to the relatively large value of 100,000 feet squared per day for all of the flowing wells. This results in the discharge rate from the flowing wells being governed by the properties of the formation and assumes that the wells themselves play a minor role in restricting flow.

Pumping discharge is a primary stress on the transient model. Pumping discharge is a cell dependent specified flow boundary. The procedural techniques used in estimating and allocating pumping are provided in Section 4.7.2. Seven user groups (municipal, manufacturing, power generation, mining, livestock, irrigation, and rural domestic) were investigated, however only three user groups (livestock, irrigation, and rural domestic) had pumping within the active model area. Once pumping was estimated for each of these three user groups, it was summed across all user groups for a given model cell (row, column, layer) and a given stress period. This process was repeated for each active cell and each stress period in the calibration period of the transient model.

The temporal distribution of pumping is discussed in Section 4.7.2. Estimates of groundwater pumping from 1980 through 2008 were provided by the TWDB. Pumping rates during the period prior to 1980 were estimated through a literature review and are considered more uncertain. The total pumping within the active model area and within the individual hydrostructural subdomains is presented in Figure 6.3.8.

The spatial distribution of pumpage to model grid cells was completed differently depending on the water use type. Irrigation and rural domestic pumping were assigned to local wells while livestock pumping was distributed areally base on land use. Because all the mining pumping was found to be outside the active model area, no mining pumping is included in the model. The spatial distribution of pumping is shown for the years 1980, 1990, and 2000 in Figures 6.3.9, 6.3.10, and 6.3.11, respectively.

As noted in Section 4.7.2, irrigation pumping in the Rustler Aquifer in Pecos and Reeves counties began in 1937. The total irrigation pumping as summarized in Table 4.7.2 was distributed evenly among all wells existing in a given year (greater than or equal to the drilling date) within a given county. In Pecos and Reeves counties, information for 31 irrigation wells is available in the TWDB well database and county reports. If the drilling date was unavailable for a given well, pumping was assumed to commence within that well at the earliest date where irrigation pumping was reported in that county. An exception is irrigation well Q-326 in Reeves County, which is located in the deep, low-conductivity portion of hydrostructural subdomain 9. This well was drilled in 1958 and no evidence of use in the well exists after May of 1959. This well was, therefore, assumed to be derelict and no irrigation pumping was distributed to it.

During transient model calibration, significant drawdowns observed in Pecos county could only be explained by additional pumping that was not included in the pumping estimates for the model. It was found that additional pumping had been allocated to the Belding Farms area that was not included in the pumping database. The calibration was improved by adjusting pumping during the period of drawdown within the allocated range of pumping. This adjustment to pumping is discussed in further detail in Section 9.1.3.

As mentioned in Section 4.7.2, only one well in Culberson County is associated with rural domestic pumping from the Rustler Aquifer. The total pumpage from Table 4.7.4 was assigned to this well.

Livestock pumping was implemented as areally-distributed pumping. The total livestock pumping as summarized in Table 4.7.3 was distributed evenly on all the active cells defined as livestock land use in a given county. The land use coverage downloaded from the GAP Analysis Program (GAP) national land cover viewer (<http://dingo.gapanalysisprogram.com/landcoverviewer/>) was used to define the livestock pumping area. Initially, all areas with scrub shrubland land use were assumed to have livestock pumping. With this assumption, however, almost the entire study area would have livestock pumping regardless of proximity to any wells. Therefore, a polygon buffering the wells in Pecos, Reeves and Culberson counties was developed to serve as the boundary for scrub shrubland land use, since the existing wells indicate there is human activity in the surrounding area. Grid cells within the intersection of the scrub

Final Groundwater Availability Model for the Rustler Aquifer

shrubland use and the polygon were defined as livestock pumping cells, and the total livestock pumping for a given county was evenly distributed among these cells.

Final Groundwater Availability Model for the Rustler Aquifer

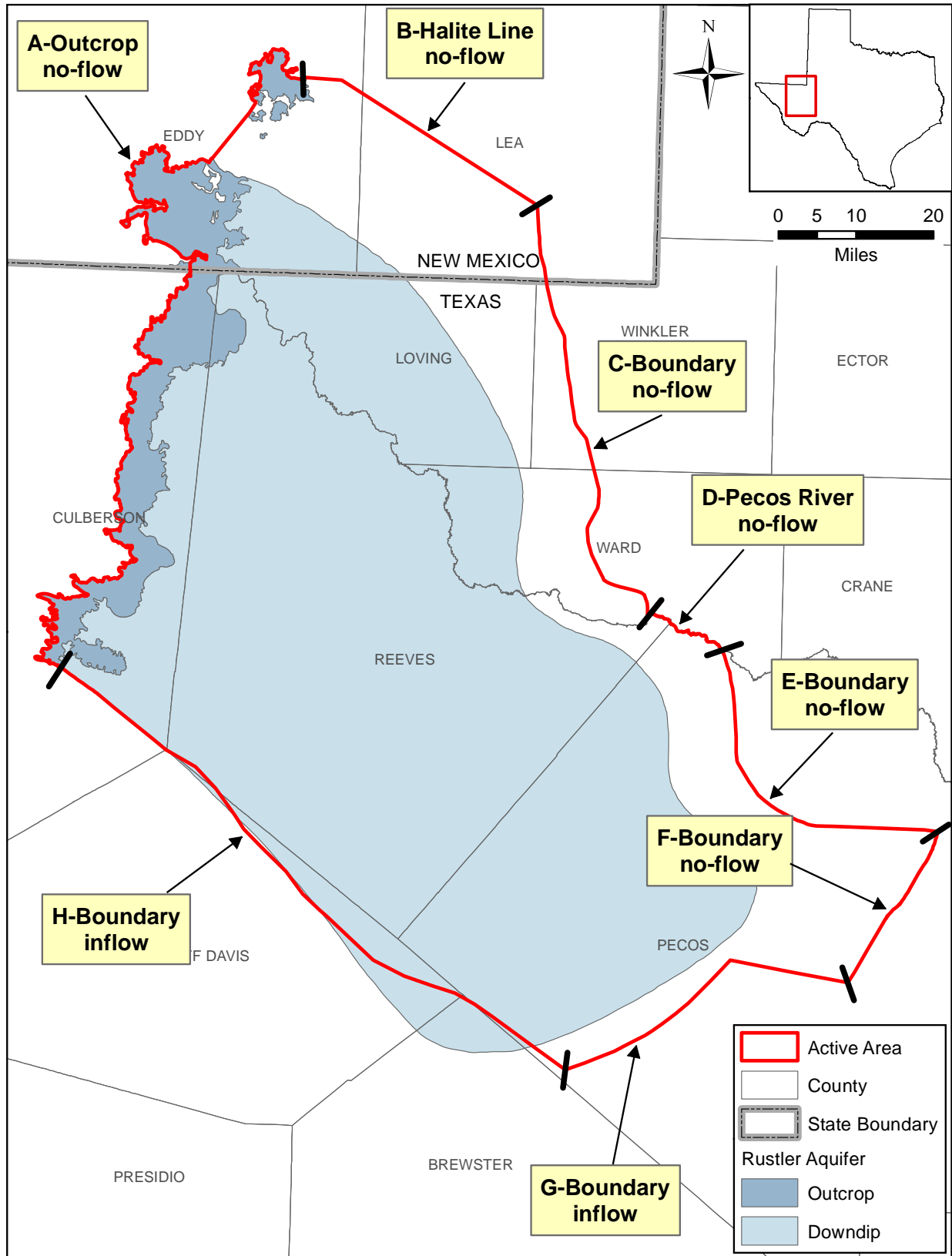
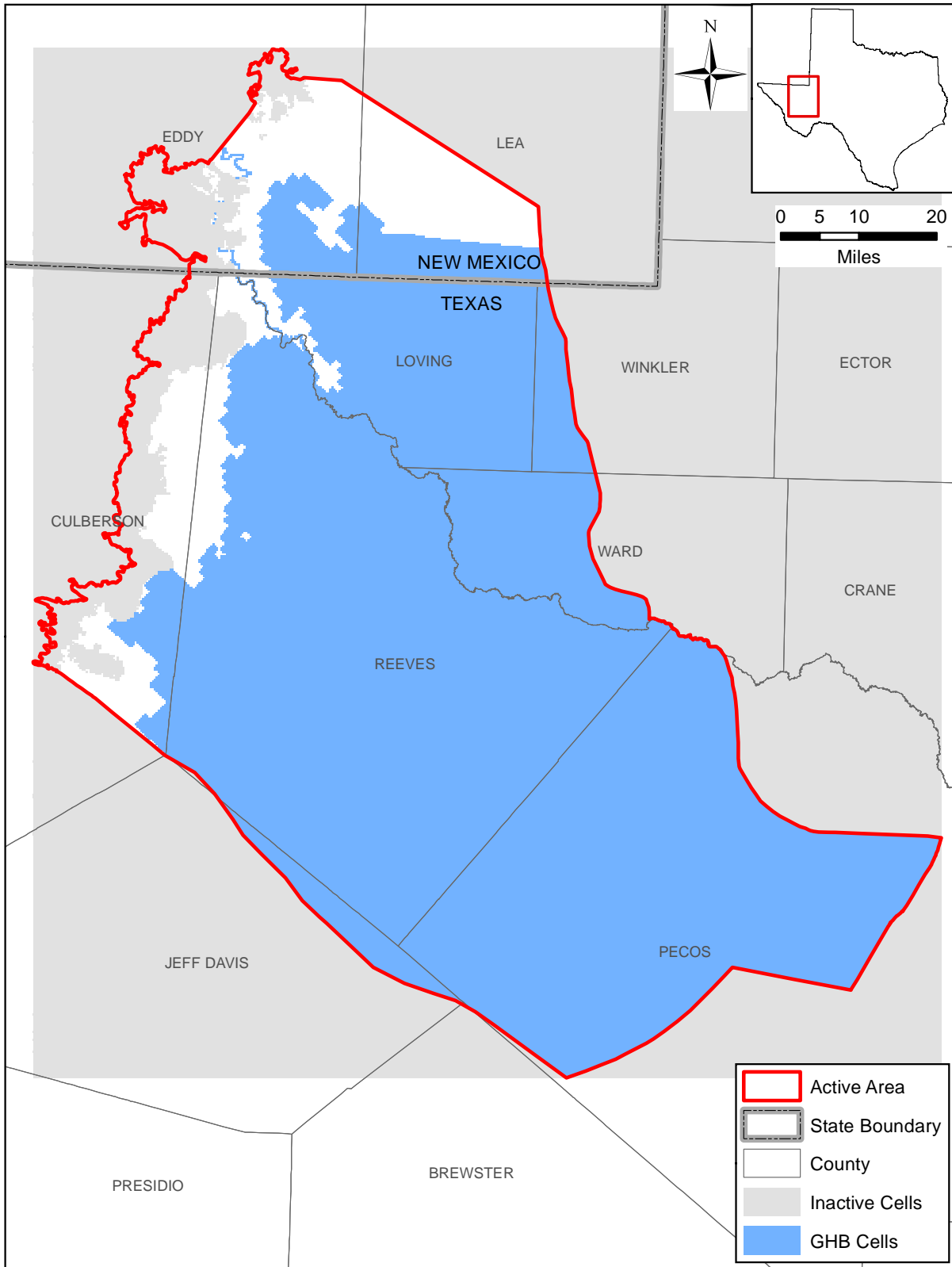

Figure 6.3.1 Boundary zones for the Rustler Aquifer GAM.

Final Groundwater Availability Model for the Rustler Aquifer



GHB = general-head boundary

Figure 6.3.2 Layer 1 boundary conditions and active/inactive cells.

Final Groundwater Availability Model for the Rustler Aquifer

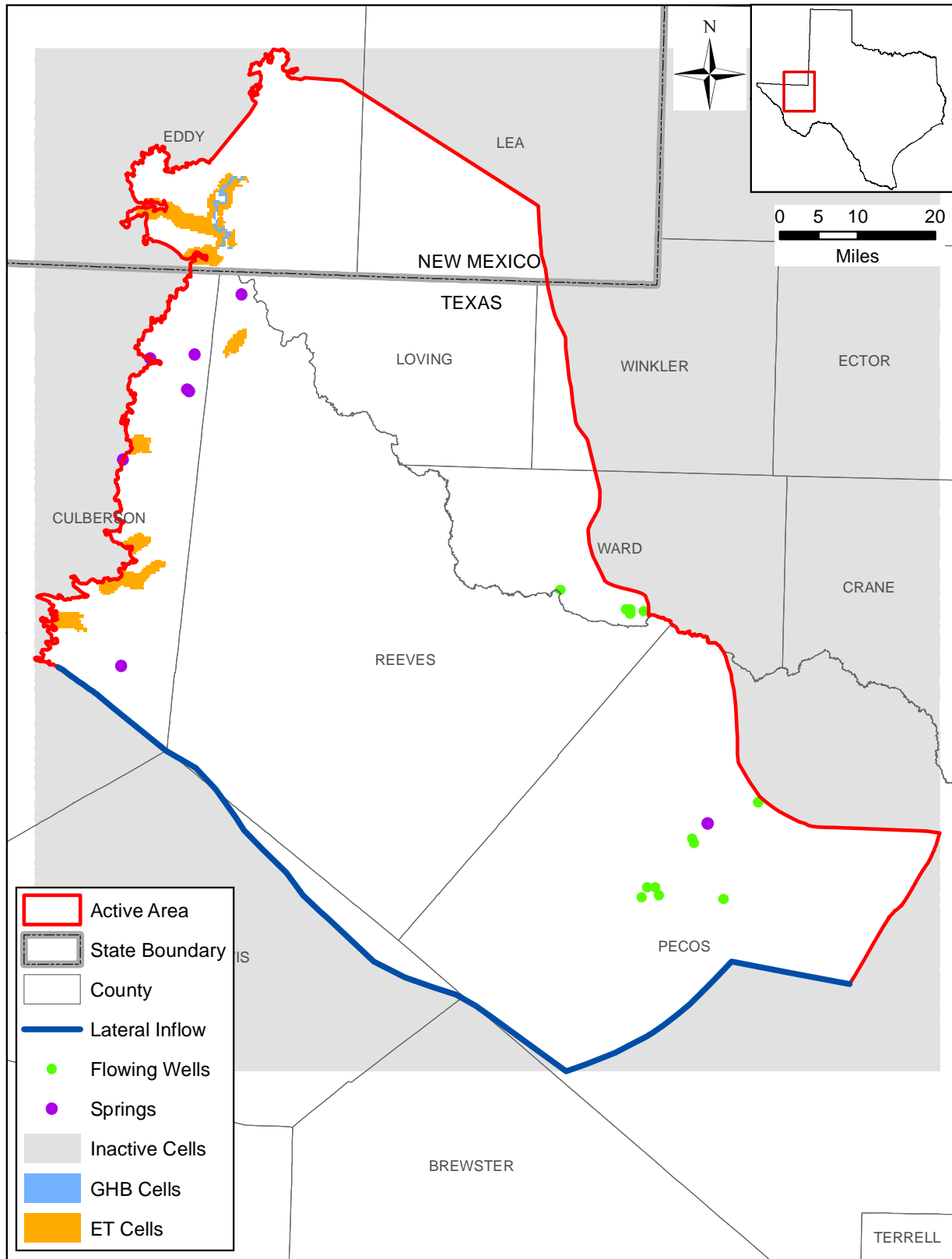

GHB = general-head boundary; ET = evapotranspiration

Figure 6.3.3 Layer 2 boundary conditions and active/inactive cells.

Final Groundwater Availability Model for the Rustler Aquifer

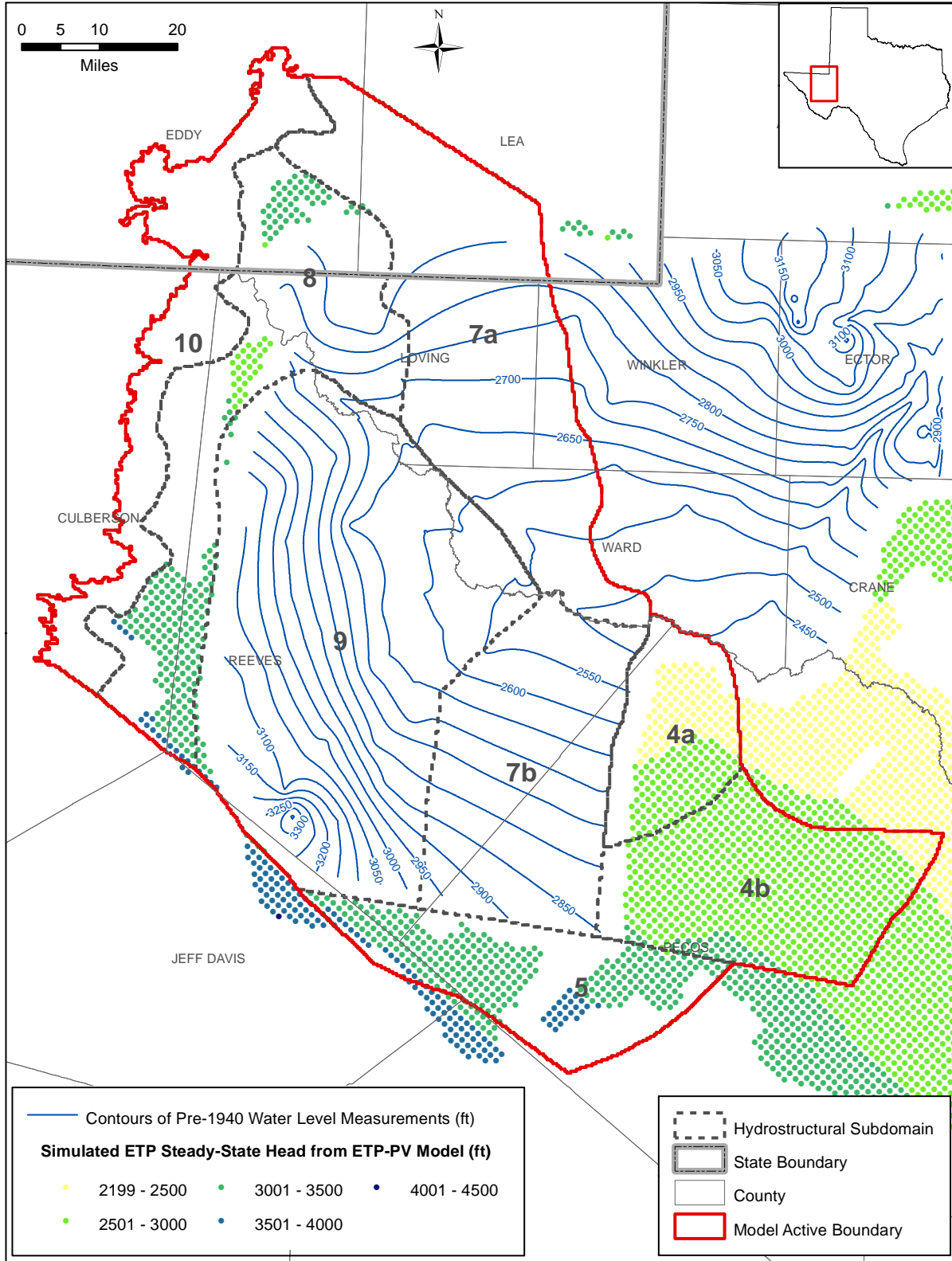

ETP = Edwards-Trinity (Plateau) Aquifer; ETP-PV = Edwards-Trinity (Plateau) and Pecos Valley aquifers

Figure 6.3.4 Head data used to develop the general head boundary heads for layer 1.

Final Groundwater Availability Model for the Rustler Aquifer

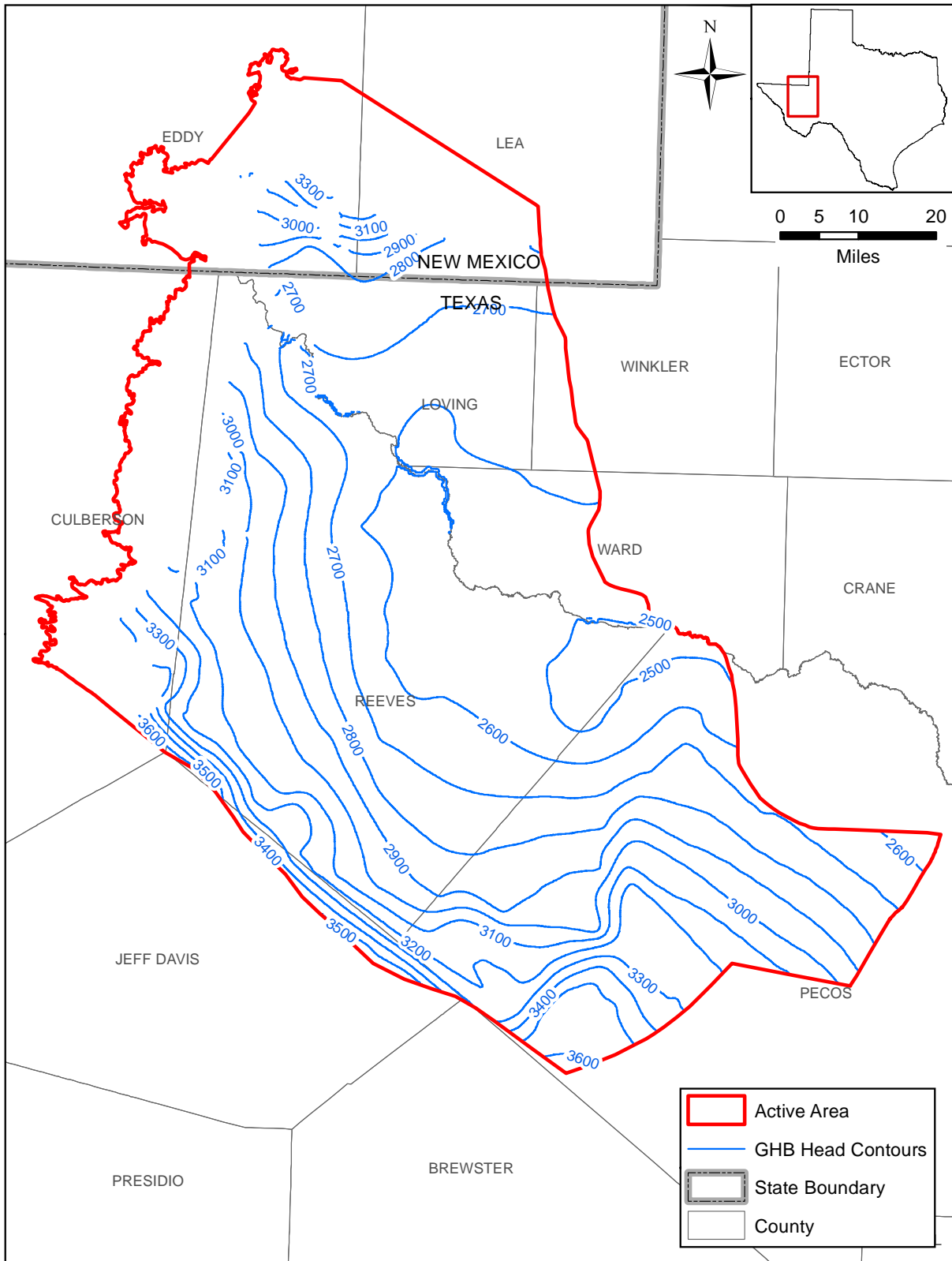

GHB = general-head boundary

Figure 6.3.5 Layer 1 general-head boundary heads.

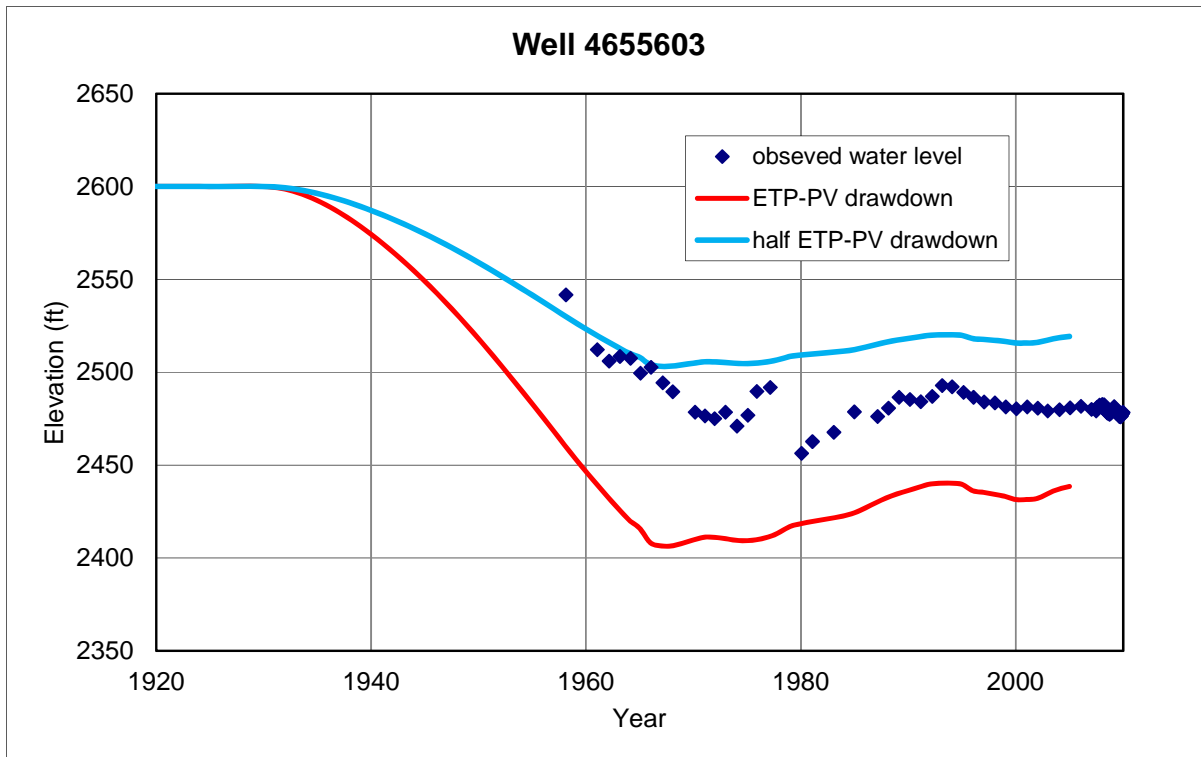
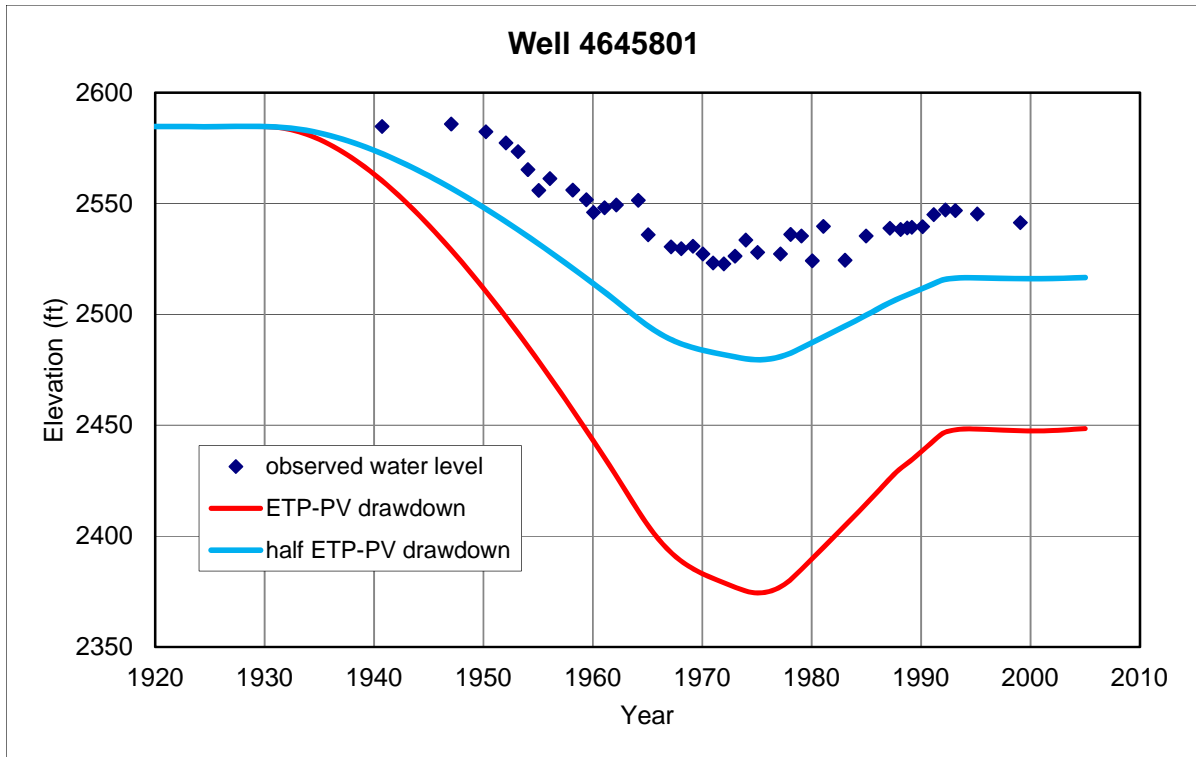

ETP = Edwards-Trinity (Plateau) Aquifer; ETP-PV = Edwards-Trinity (Plateau) and Pecos Valley aquifers

Figure 6.3.6 General-head boundary head adjustment to simulated drawdown in the Edwards-Trinity (Plateau) and Pecos Valley aquifers based on observed water levels.

Final Groundwater Availability Model for the Rustler Aquifer

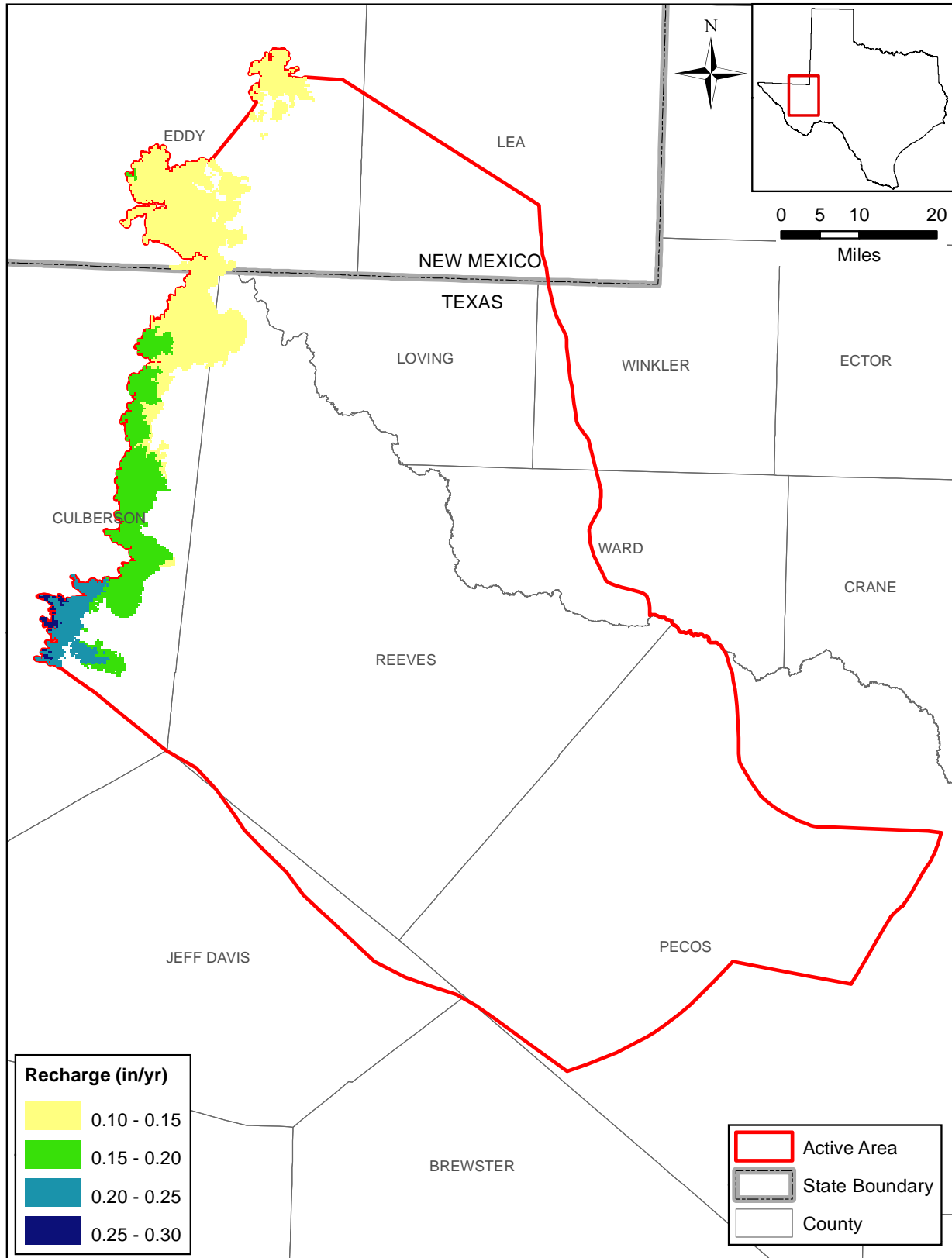

Figure 6.3.7 Recharge distribution in inches per year.

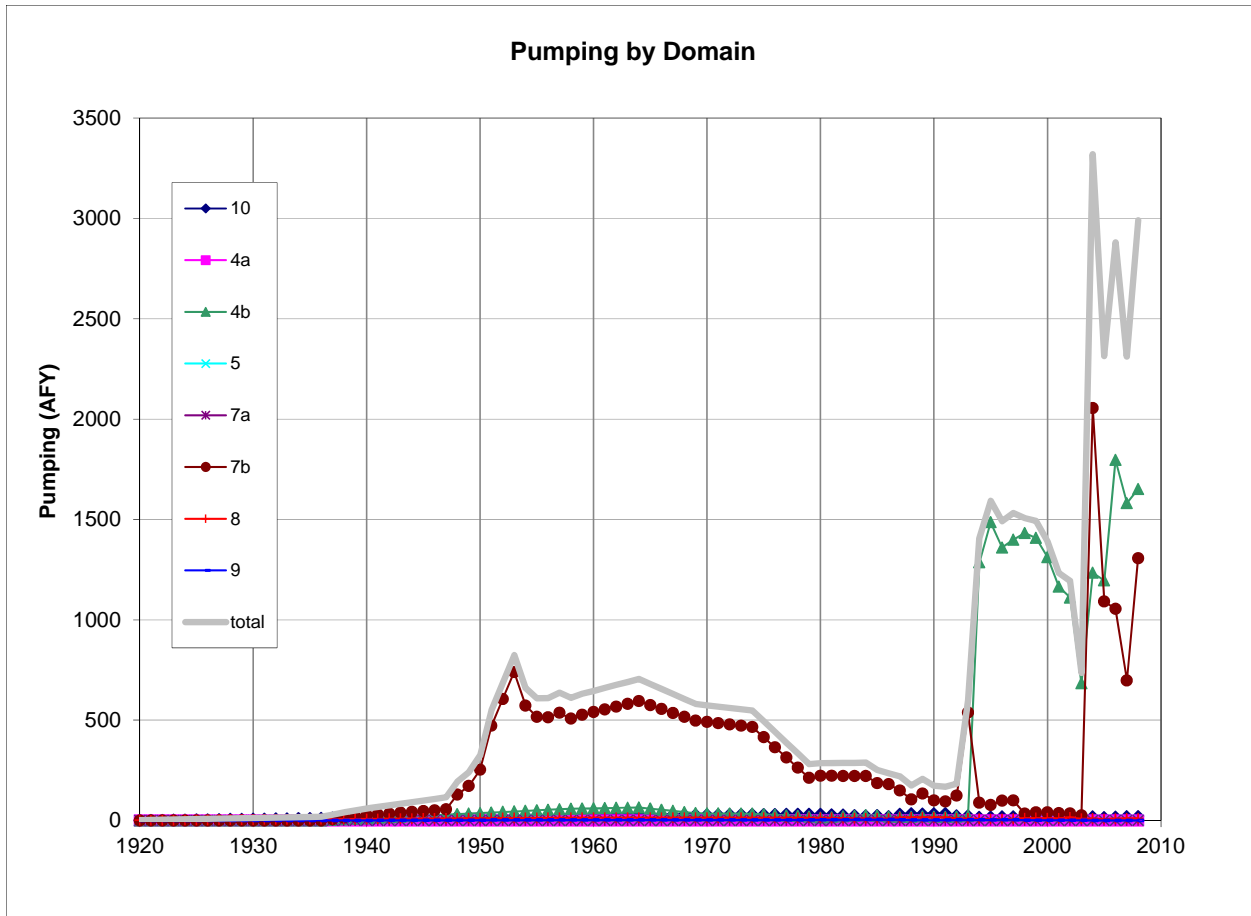

Figure 6.3.8 Temporal pumping distribution in acre-feet per year for the entire Rustler Aquifer and by subdomain.

Final Groundwater Availability Model for the Rustler Aquifer

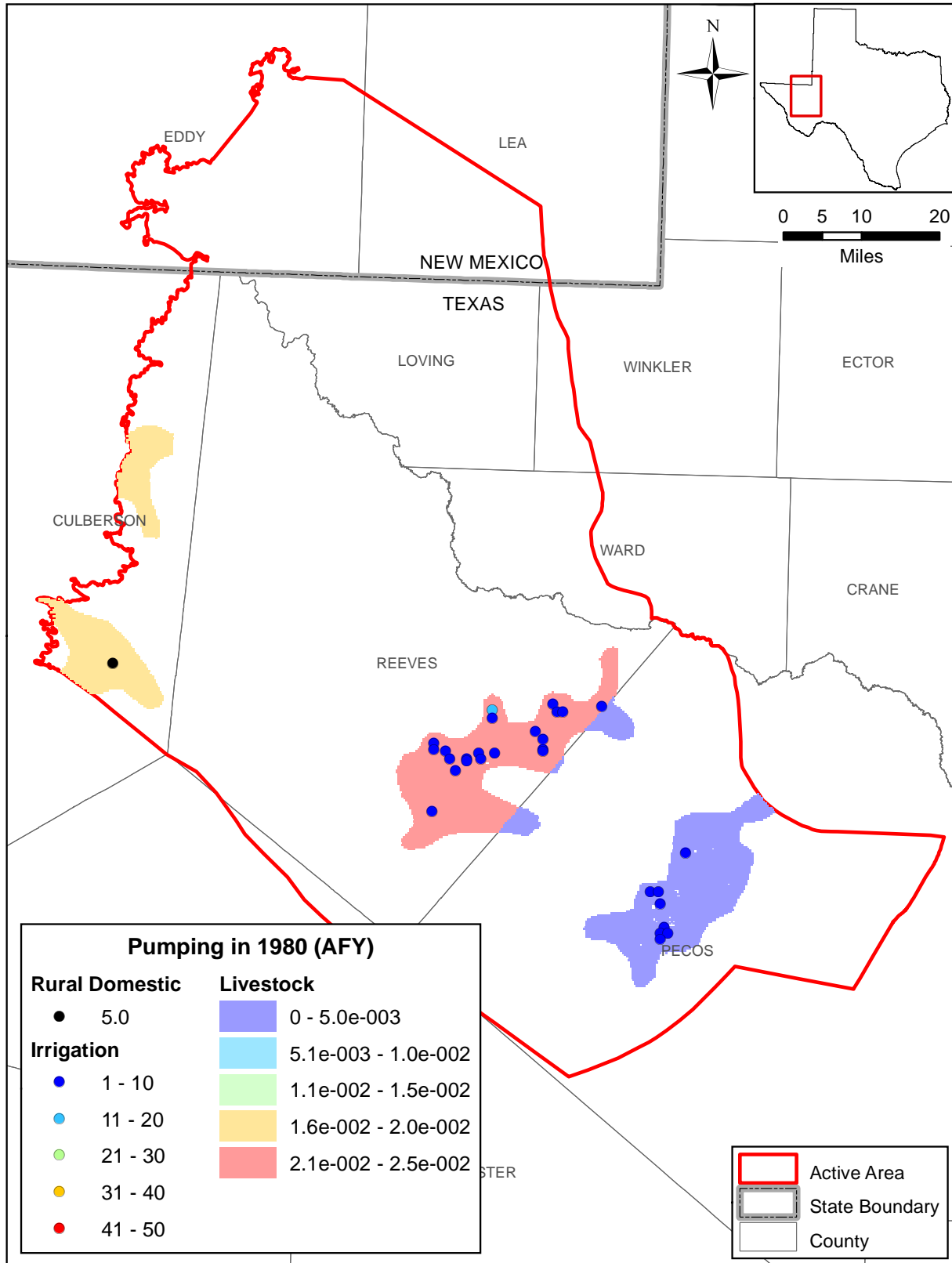

Figure 6.3.9 Pumping distribution in acre-feet per year for the Rustler Aquifer in 1980.

Final Groundwater Availability Model for the Rustler Aquifer

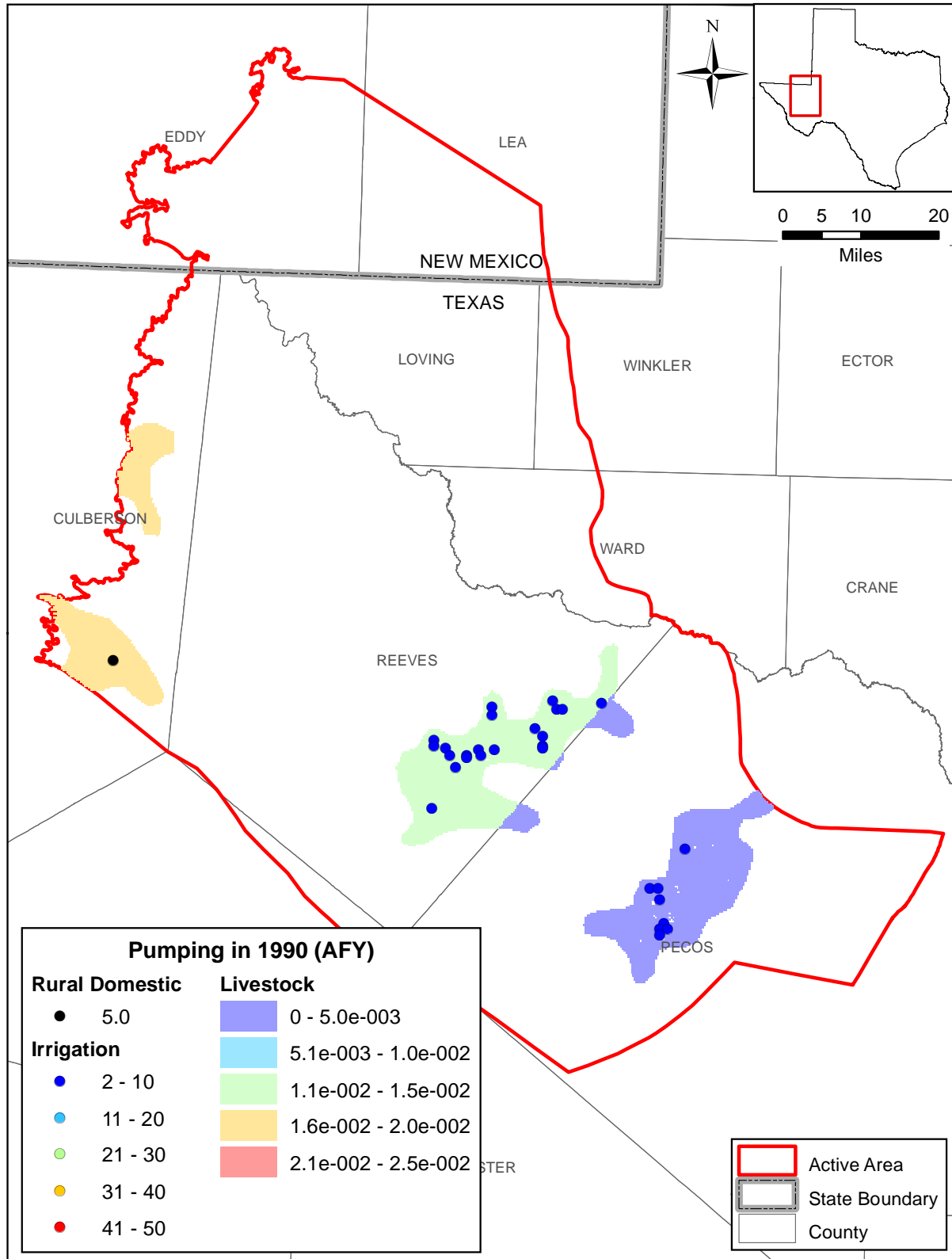

Figure 6.3.10 Pumping distribution in acre-feet per year for the Rustler Aquifer in 1990.

Final Groundwater Availability Model for the Rustler Aquifer

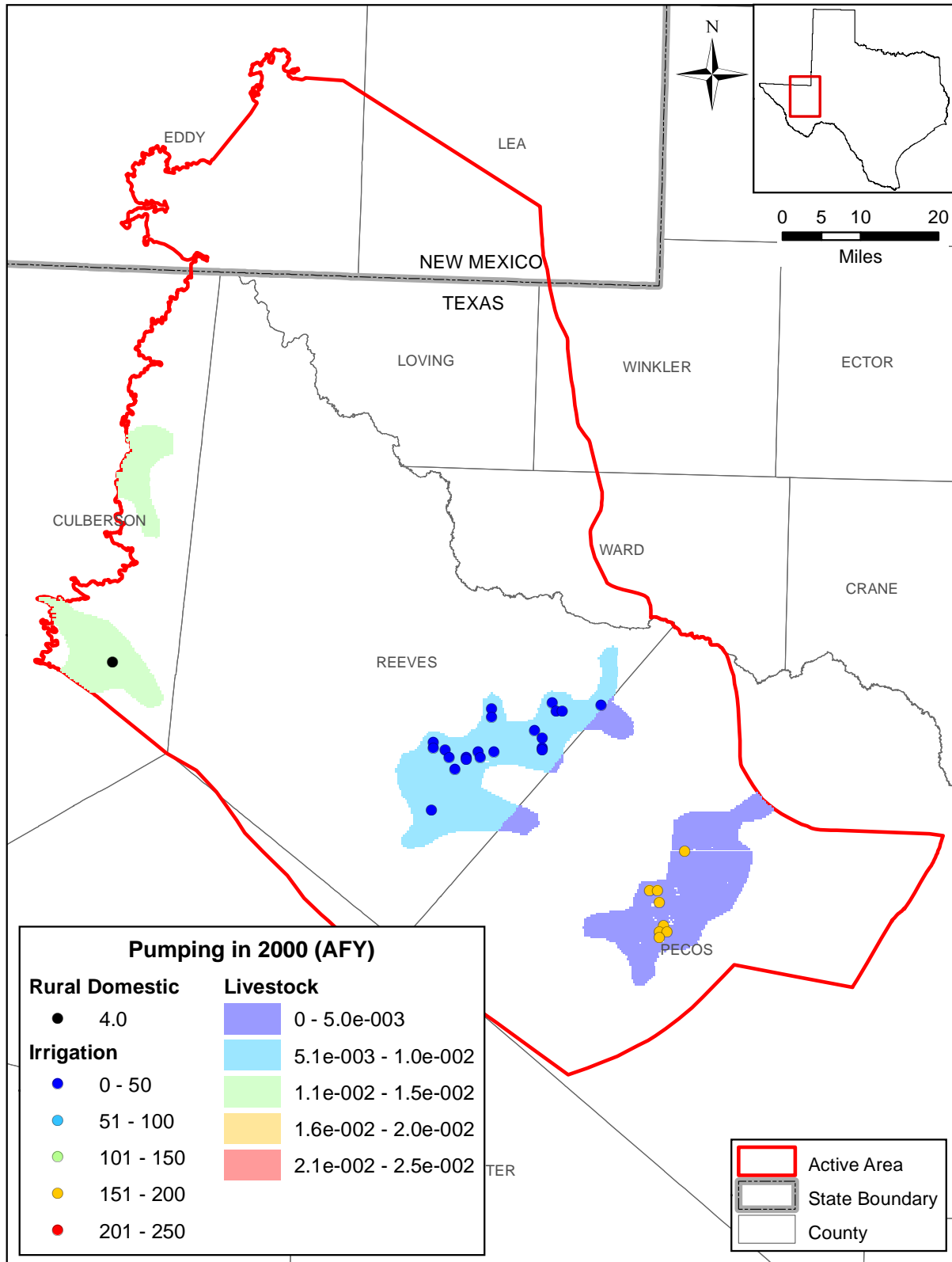

Figure 6.3.11 Pumping distribution in acre-feet per year for the Rustler Aquifer in 2000.

6.4 Model Hydraulic Parameters

For the steady-state model, the primary hydraulic parameter to be estimated and distributed across the model grid is hydraulic conductivity. For the transient model, the storage coefficient must also be included. The following sections describe the methods used to distribute hydraulic conductivity and storage in the model domain.

6.4.1 Hydraulic Conductivity

In the model, properties are constant within a given grid block. Each grid block in the Rustler Aquifer GAM is a quarter-mile by quarter-mile square and varies in thickness from a minimum of 100 feet to a maximum of approximately 2,500 feet. One of the challenges in constructing a regional model is development of an accurate “effective” hydraulic conductivity field that is representative of the different lithologies present in each grid cell. In many models, the use of detailed lithologic data within the aquifer is used to develop grid-scale estimates of effective hydraulic conductivity. Many investigations exist regarding estimating average effective hydraulic conductivity given assumptions for flow dimension, layer geometry, and correlation scales (Warren and Price, 1961; Gutjahr and others, 1978). For one-dimensional flow in lithologies combined in parallel (i.e., layered), the appropriate effective hydraulic conductivity would be the weighted arithmetic mean. For one-dimensional flow in lithologies combined in series, the effective hydraulic conductivity is the harmonic mean. Hydraulic conductivity has been found to be a log-normally distributed parameter in many studies. In two-dimensional uniform flow, assuming that the hydraulic conductivity is log-normally distributed and randomly juxtaposed, the effective hydraulic conductivity is exactly the geometric mean (de Marsily, 1986).

For the Rustler Aquifer, detailed lithologic data are not available for developing effective hydraulic property estimates. Based upon the available information reviewed in Section 4.6, a conceptual understanding of the hydraulic properties of the Rustler Aquifer was developed along with some understanding of what portions of the aquifer are very productive versus very unproductive. The effective hydraulic conductivities for the Rustler Aquifer were developed based on this conceptual understanding of the aquifer.

For model layer 1 (Dewey Lake and Dockum formations), uniform properties were applied. The horizontal hydraulic conductivity was initially assumed to be 0.1 feet per day where either the Dewey Lake or Dockum formation is present. Where neither formation was present in layer 1 in a small area abutting the Rustler Aquifer outcrop, younger alluvium is assumed to overlie the Rustler Aquifer. This alluvium is assumed to have a much higher hydraulic conductivity than the Dewey Lake and Dockum formations and a value of 10 feet per day was used there. Because the only purpose of layer 1 is to simulate the impact of the Edwards-Trinity (Plateau) and Pecos Valley aquifer heads on the Rustler Aquifer through the Dewey Lake and Dockum formations, this rudimentary description of layer 1 properties was deemed sufficient.

For the Rustler Aquifer, horizontal hydraulic conductivity was assigned according to the hydrostructural subdomains discussed in Sections 4.2, 4.6 and 5.0. For all but the subdomain corresponding to the outcrop, the hydraulic conductivity was initially assumed to decay with depth. This conceptual model is based on transmissivity measurements in the Culebra Dolomite Member of the Rustler Formation in Eddy County, New Mexico (see Section 4.6.4). The effective horizontal hydraulic conductivity for layers 1 and 2 are depicted in Figures 6.4.1 and 6.4.2, respectively. The resulting transmissivity of the Rustler Aquifer is shown in Figure 6.4.3.

Vertical hydraulic conductivity is not measurable on a regional model scale and is, therefore, generally a parameter that is calibrated within predefined limits. The vertical hydraulic conductivity for layers 1 and 2 was initially estimated using a vertical anisotropy ratio of 1,000. Here, vertical anisotropy refers to the ratio of horizontal hydraulic conductivity to vertical hydraulic conductivity. Typical vertical anisotropy ratios are on the order of 1 to 1,000 determined from model applications (Anderson and Woessner, 1992). At the regional scale of the Rustler Aquifer GAM, anisotropy ratios at the higher end of the range are expected. The effective vertical hydraulic conductivity for layers 1 and 2 are depicted in Figures 6.4.4 and 6.4.5, respectively.

6.4.2 *Fault Conductance*

Numerous faults with significant vertical displacement affect the structure of the Rustler Aquifer dividing the aquifer, in some areas, into relatively isolated flow domains. The effect of these faults on the hydraulic properties of the Rustler Aquifer was implemented through the

MODFLOW horizontal flow barrier package. The horizontal flow barrier package results in an added horizontal resistance to flow between groups of neighboring grid cells through a prescribed conductance term. To determine the appropriate horizontal flow barrier conductances for portions of the faults within the aquifer, the vertical displacement across the faults was divided into three groups. Where large displacements exist and adjacent portions of the aquifer are completely disconnected, a relatively low horizontal flow barrier conductance value of 0.01 feet squared per day was used. Where moderate displacements and small connectivity exists between adjacent portions of the aquifer, a mid-range horizontal flow barrier conductance value of 1 feet squared per day was used. Where smaller displacements and large connectivity exists between adjacent portion of the aquifer, a relatively large horizontal flow barrier conductance value of 100 feet squared per day was used. The locations and initial conductance of the horizontal flow barriers are depicted in Figure 6.4.6. The horizontal flow barrier conductances were adjusted during model calibration based on simulated flow behavior while maintaining the initial hierarchy.

6.4.3 Storage Coefficient

For unconfined aquifer conditions, the specific yield was assumed to be homogeneous and was assigned a value equal to 0.15. As mentioned in Section 6.2, grid cells that represented outcrop (land surface) were modeled as confined to avoid problems with model convergence. Because the specific storage is the required input for confined cells in the upstream weighting package, a value of specific storage equal to the specific yield divided by the cell thickness was used as input for outcrop cells.

A total of six confined storage estimates are available for the Culebra Dolomite Member of the Rustler Formation in Eddy County, New Mexico (see Section 4.6.6). Storativity estimates ranged in magnitude from 1.5×10^{-5} to 5.7×10^{-4} . This corresponds to an approximate range in specific storage from 6×10^{-7} to 2×10^{-5} per foot. The location of these estimates is too limited to directly generate a spatial distribution by kriging or other mapping technique. Instead, an initial uniform specific storage of 1×10^{-6} per foot was assumed. The storativity is calculated by multiplying this uniform specific storage value by the varying layer thickness. The corresponding storativity values for layers 1 and 2 are shown in Figures 6.4.7 and 6.4.8, respectively.

Final Groundwater Availability Model for the Rustler Aquifer

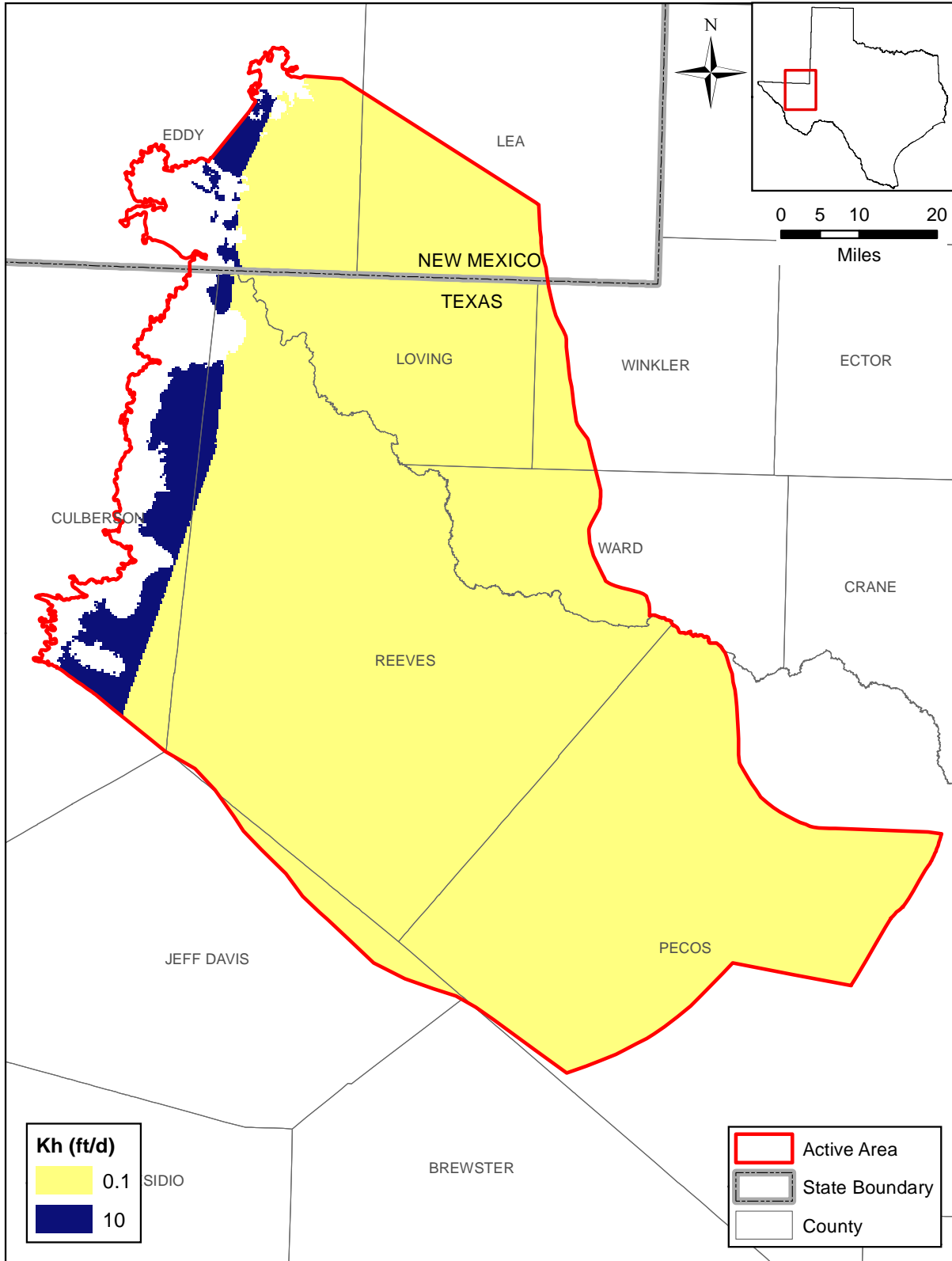

Figure 6.4.1 Layer 1 horizontal hydraulic conductivity (Kh) in feet per day.

Final Groundwater Availability Model for the Rustler Aquifer

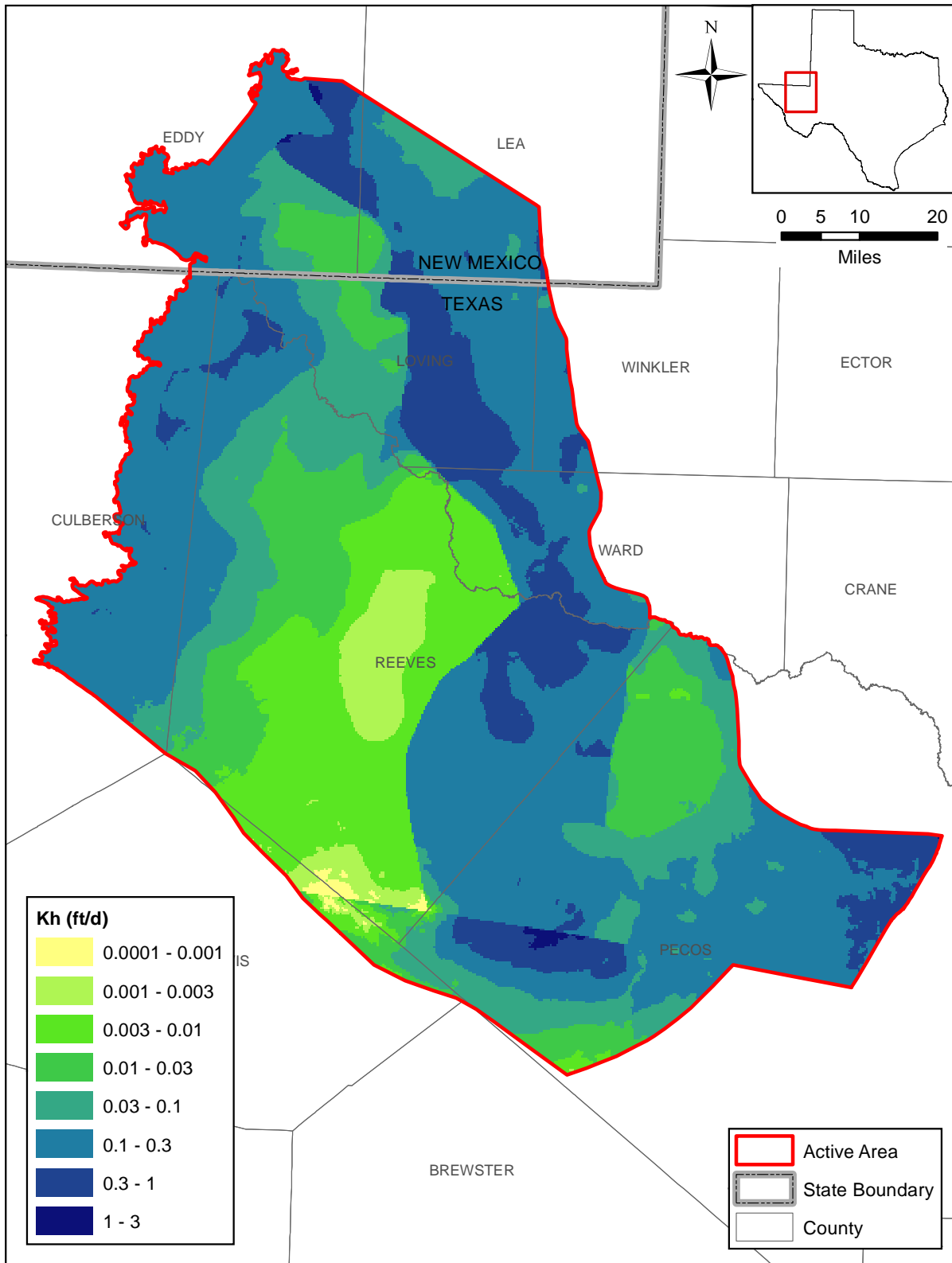

Figure 6.4.2 Layer 2 horizontal hydraulic conductivity (Kh) in feet per day.

Final Groundwater Availability Model for the Rustler Aquifer

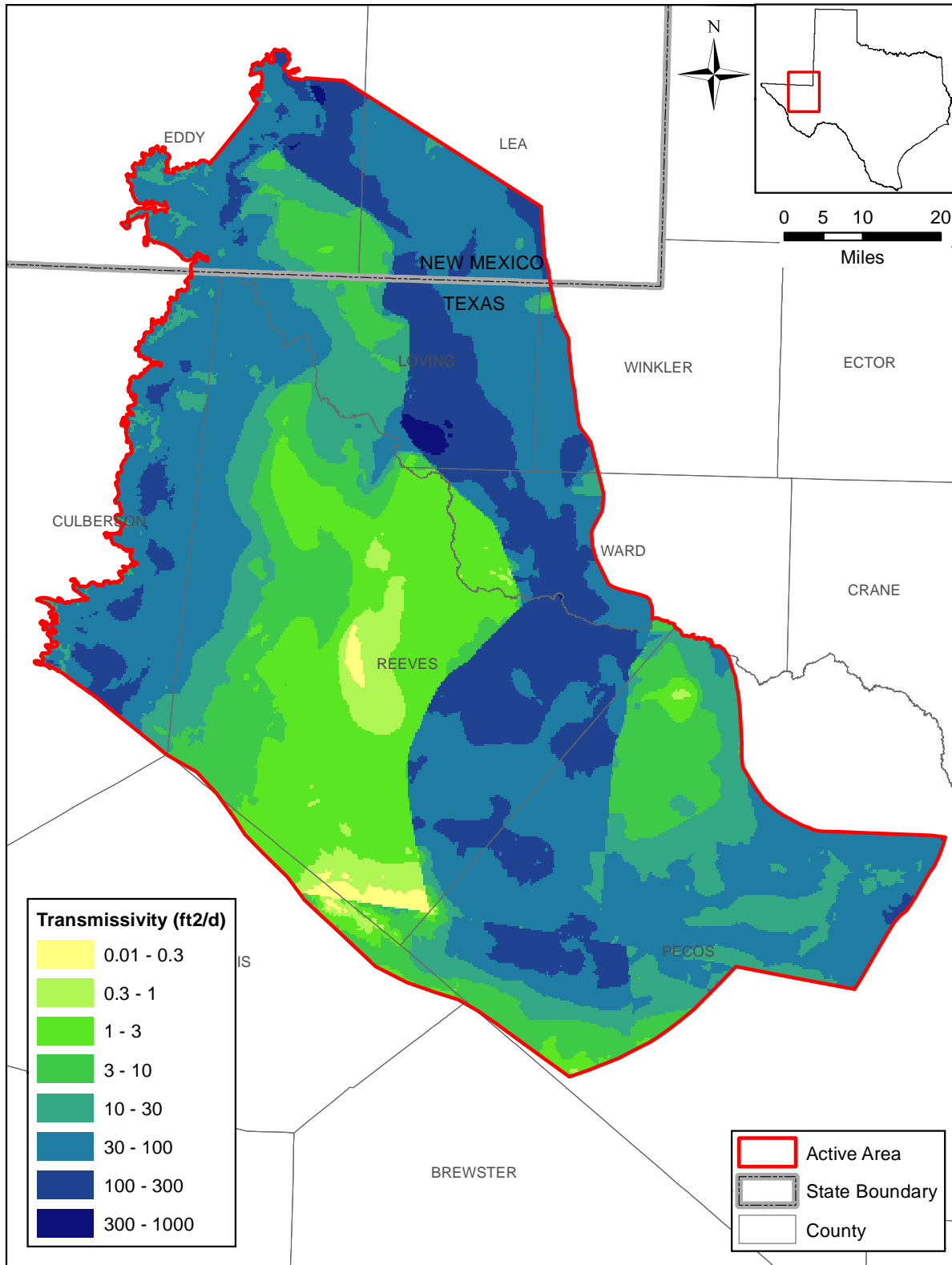

Figure 6.4.3 Layer 2 transmissivity in feet squared per day.

Final Groundwater Availability Model for the Rustler Aquifer

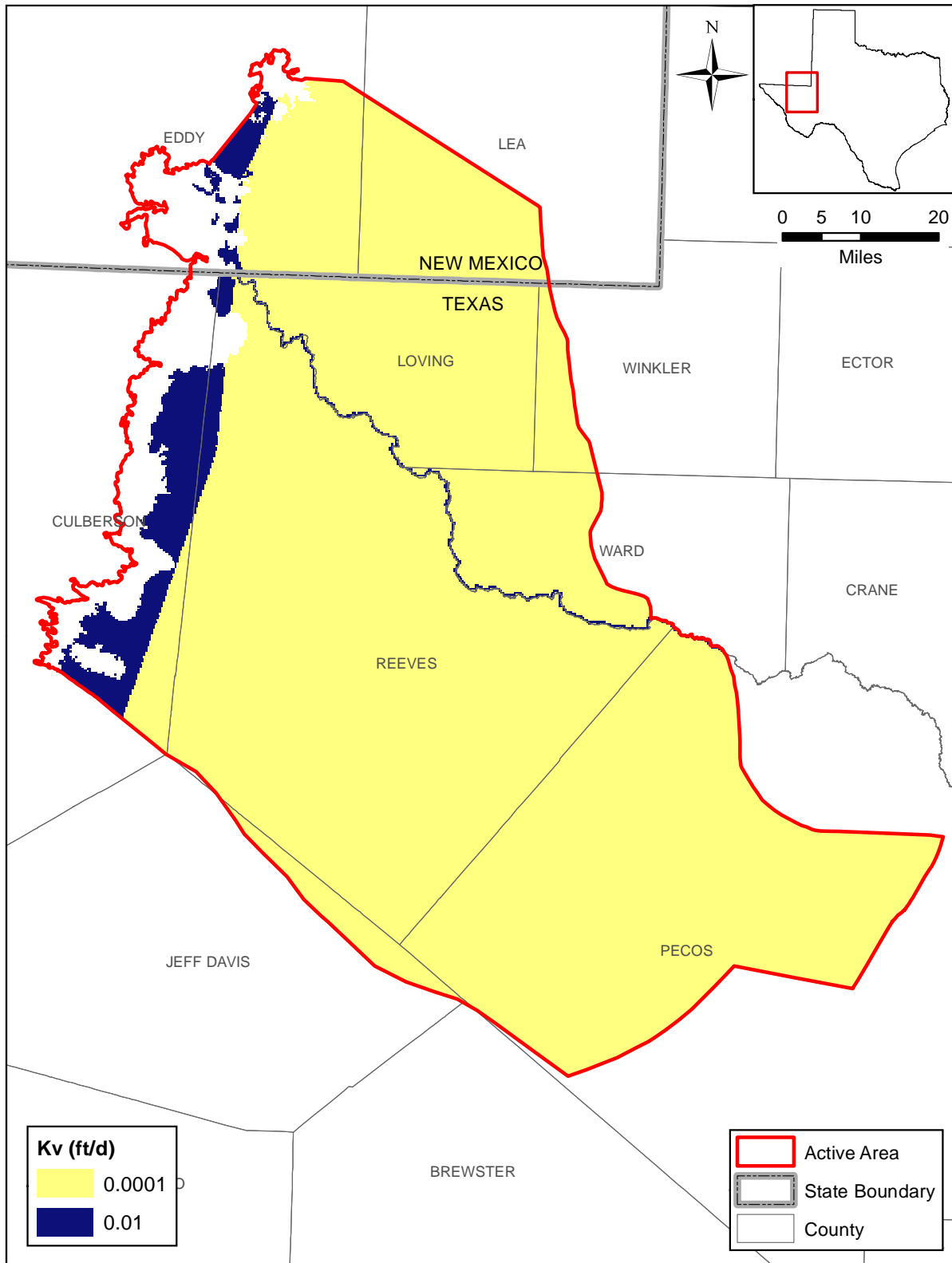

Figure 6.4.4 Layer 1 vertical hydraulic conductivity (Kv) in feet per day.

Final Groundwater Availability Model for the Rustler Aquifer

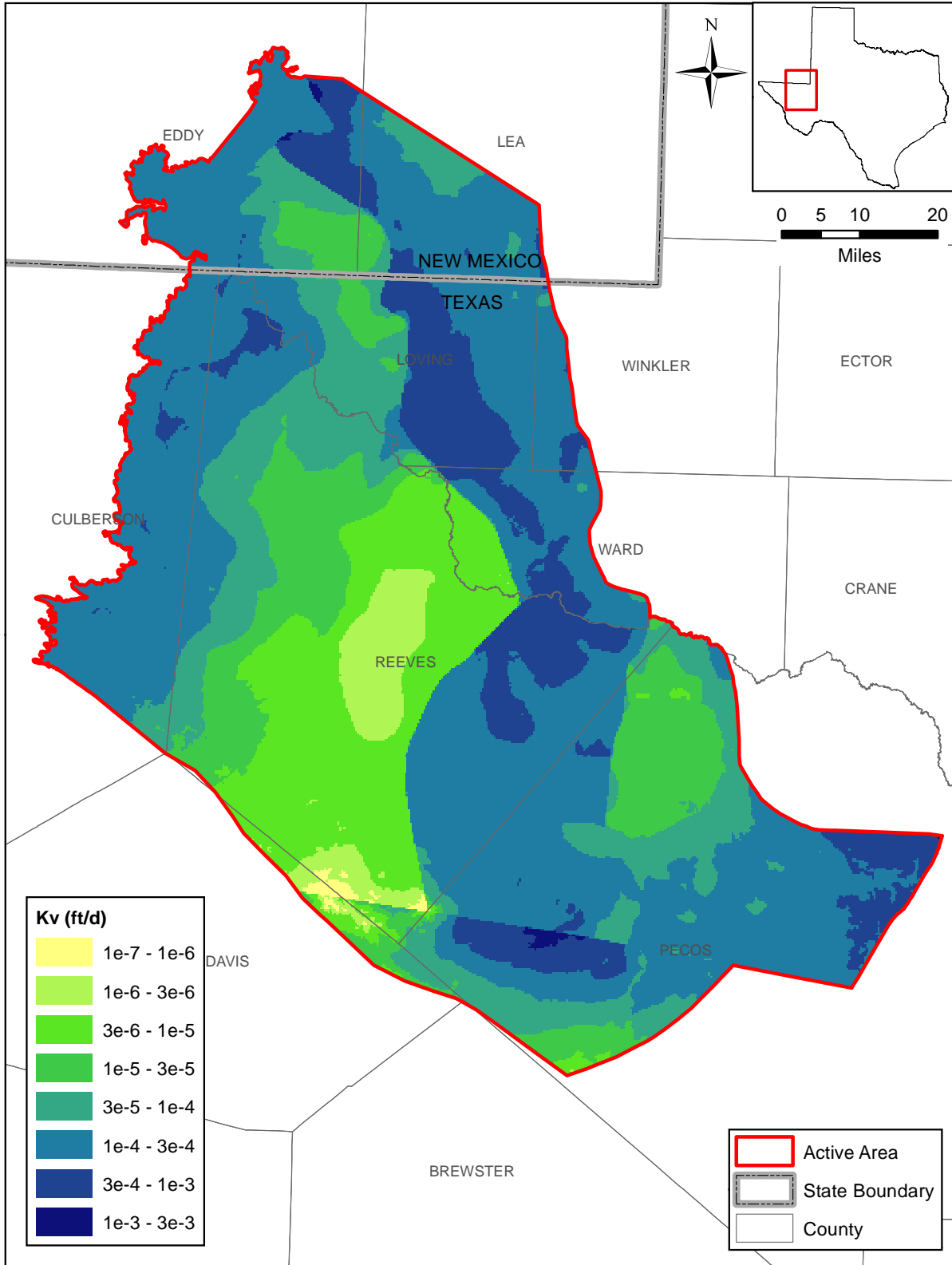

Figure 6.4.5 Layer 2 vertical hydraulic conductivity (Kv) in feet per day.

Final Groundwater Availability Model for the Rustler Aquifer

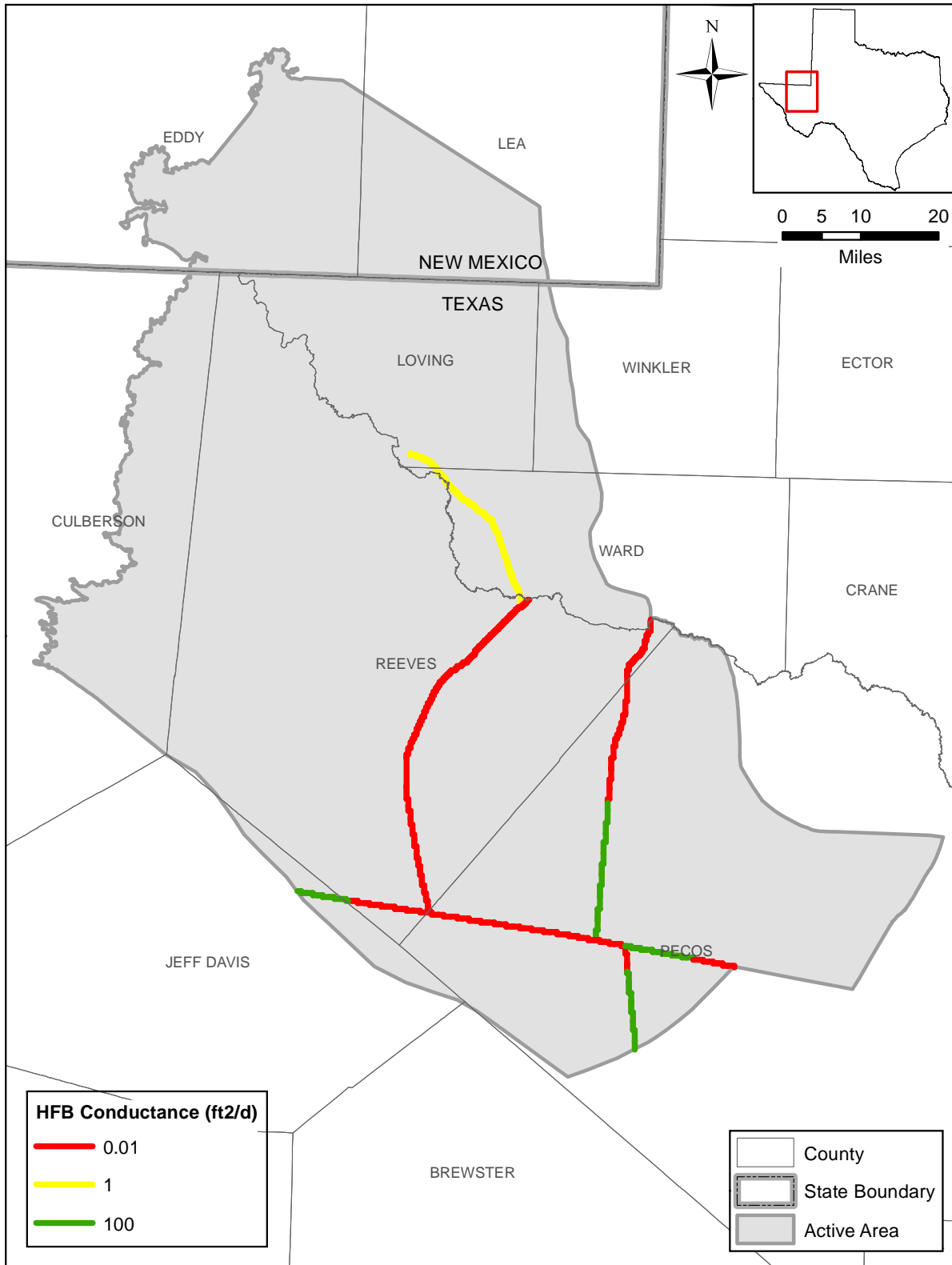

Figure 6.4.6 Layer 2 horizontal flow barrier (HFB) conductances.

Final Groundwater Availability Model for the Rustler Aquifer

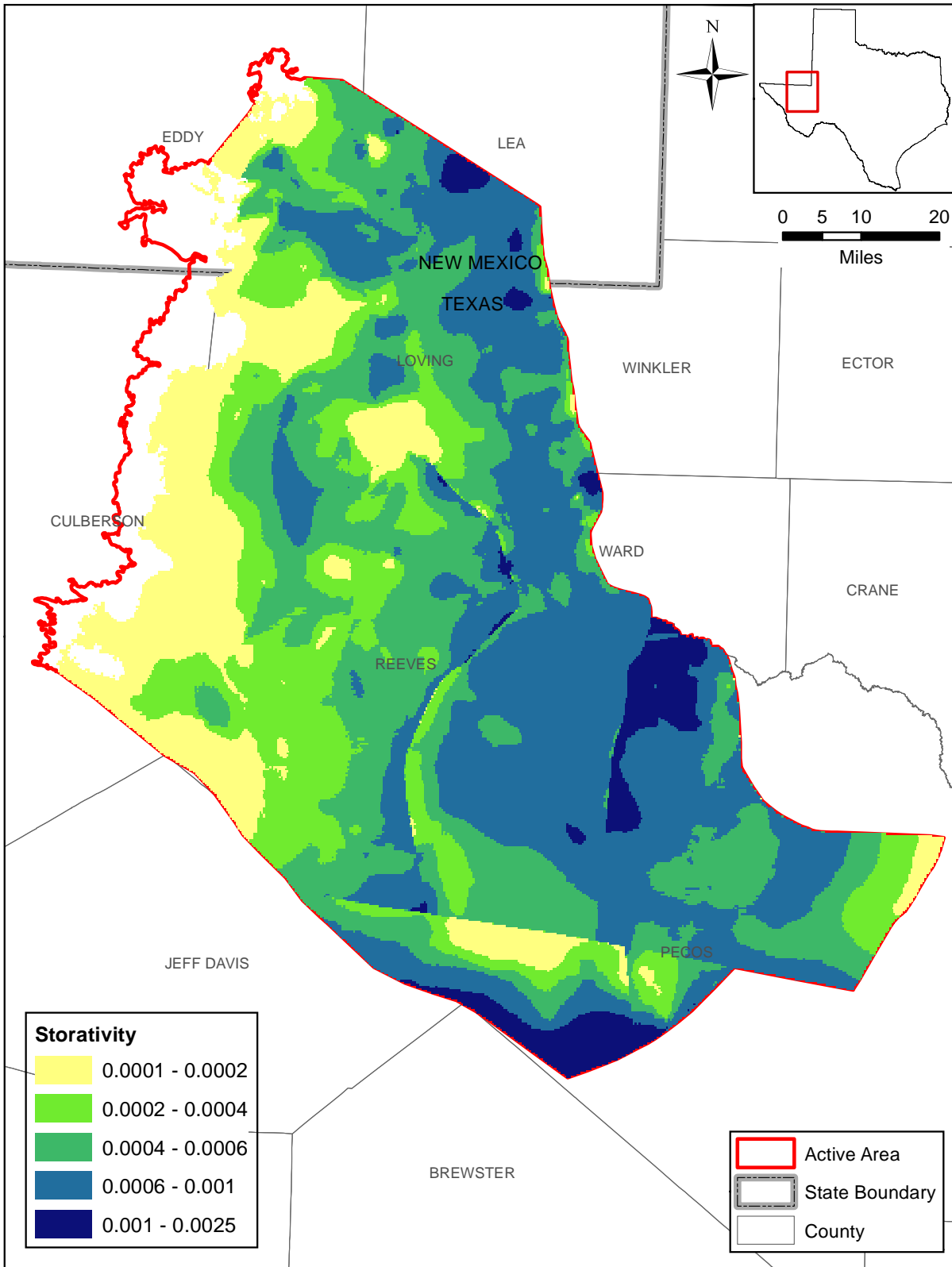

Figure 6.4.7 Layer 1 storativity.

Final Groundwater Availability Model for the Rustler Aquifer

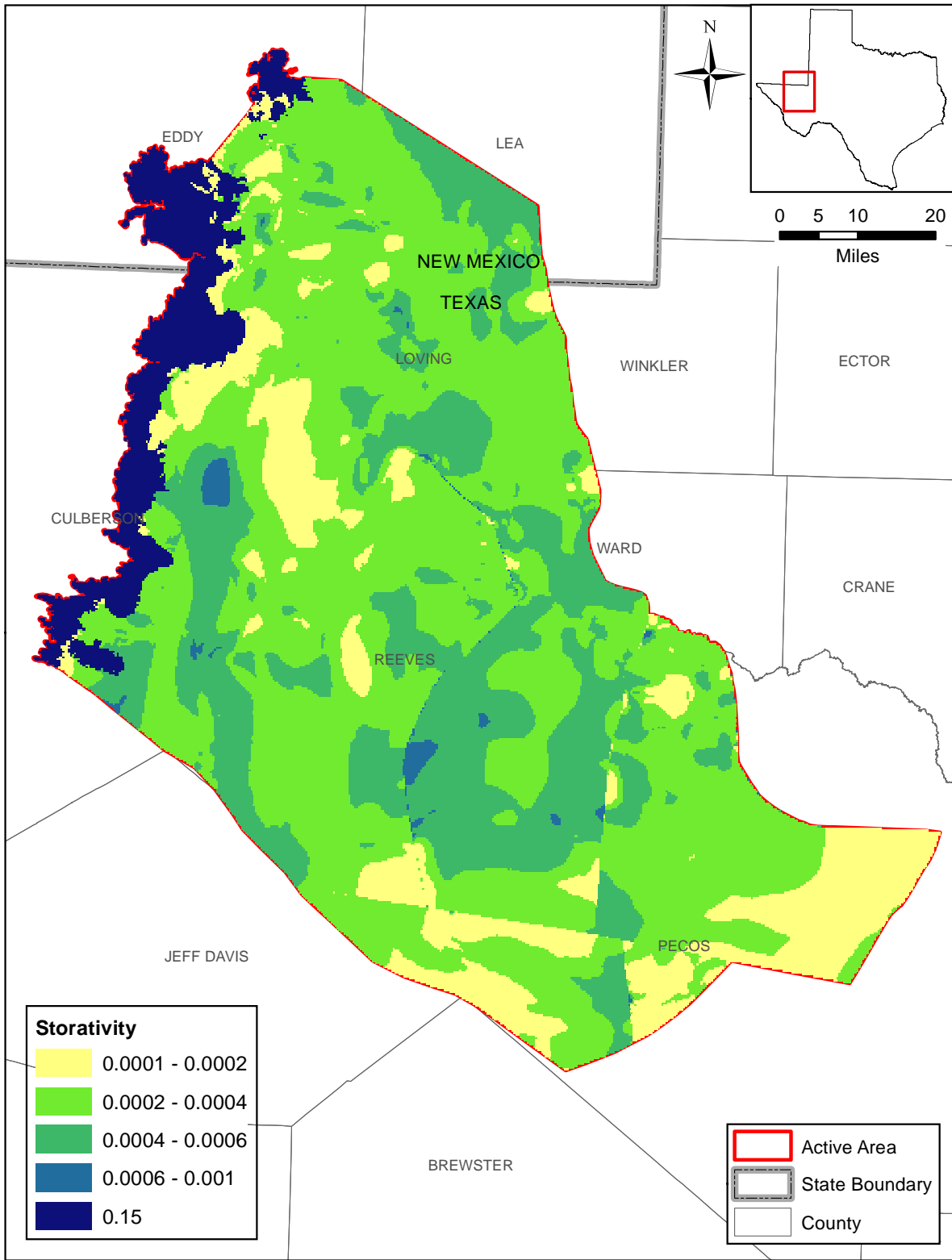

Figure 6.4.8 Layer 2 storativity.

This page intentionally left blank.

7.0 Modeling Approach

The modeling approach included model calibration and model sensitivity analysis. In the context of groundwater modeling, model calibration can be defined as the process of producing an agreement between model simulated water levels and aquifer discharge, and field measured water levels and aquifer discharge through the adjustment of independent variables. Because the steady-state and transient models are combined within a single model, changes to the model made during calibration were propagated to both the steady-state and transient models. The generally accepted practice for groundwater calibration includes performance of a sensitivity analysis. A sensitivity analysis entails the systematic variation of the calibrated parameters and stresses with re-simulation of aquifer conditions. Those parameters which strongly change the simulated aquifer water levels and discharges are important parameters to the calibration. It is important to note that a standard “one-off” sensitivity analysis does not estimate parameter uncertainty, since limited parameter space is investigated and parameter correlation is not considered.

7.1 Calibration

Groundwater models are inherently non-unique, meaning that multiple combinations of hydraulic parameters and aquifer stresses can reproduce measured aquifer water levels. To reduce the impact of non-uniqueness, a calibration method described by Ritchey and Rumbaugh (1996) was employed. This method includes (1) calibrating the model using parameter values (i.e., hydraulic conductivity, storage coefficient, and recharge) that are consistent with measured values, (2) calibrating to multiple hydrologic conditions, and (3) using multiple calibration performance measures, such as water levels and discharge rates, to assess calibration. Each of these elements is discussed below.

While several hydraulic property data are available for the Rustler Aquifer, only one data location lies within the active model area. The average hydraulic properties and their spatial distribution within the aquifer are, therefore, very poorly constrained. A hierarchy of magnitudes of transmissivity has been inferred, however, and is presented in Figure 4.6.7. Spatial trends related to depth have also been inferred based on measurements within the Rustler Aquifer at the WIPP site as described by Figures 4.6.2 through 4.6.4. An assumed specific yield value for the

Rustler Aquifer of 0.15 is considered well constrained within literature values (Richey and others 1985). Storativity for the Rustler Aquifer was initially set uniformly to 1×10^{-6} based on typical literature values. Although estimates of recharge as a percentage (one percent) of precipitation were used, the magnitude and spatial distribution of recharge are poorly constrained. Adjustment of all model parameters were held within plausible ranges based upon the available data and relevant literature. Adjustments to aquifer parameters from initial estimates were minimized, to the extent possible, to meet the calibration criteria. As a general rule, parameters with few measurements were adjusted preferentially as compared to parameters with good supporting data.

The model was calibrated for two time periods, one representing steady-state conditions and the other representing transient conditions. The steady-state calibration considers a “predevelopment” time period prior to extensive aquifer development. The transient calibration period ran from 1919 through 2008 to include as many water-level observations as possible and to incorporate the historical period of greatest groundwater development in the 1960s and 1970s. Section 4.3 describes the aquifer water levels and how they were derived for use in the steady-state and transient calibration periods. Pumping estimates based upon historical records were applied on an annual time scale in the transient calibration period. Recharge and stream stage remain constant throughout the transient period.

The model was calibrated through a wide range of hydrological conditions. The steady-state model represents a period of equilibrium where aquifer recharge and aquifer discharge are in balance. The transient calibration period (1919 through 2008) represents a time of transient aquifer behavior. The transient calibration period also helps to constrain the model parameterization because a wider range of hydrologic conditions are encountered and simulated. The sensitivity of the transient model to certain parameters differs from that of the steady-state model.

Calibration requires development of calibration targets and specification of calibration measures. To address the issue of non-uniqueness, it is best to use as many types of calibration targets as possible. The primary type of calibration target is hydraulic head (water level). Stream leakages were also qualitatively used and the model was evaluated with respect to cross-formational flow to the aquifers overlying the Rustler Aquifer. Simulated water levels were compared to

measured water levels at specific observation points through time (hydrographs) to ensure that model water levels are consistent with hydrogeologic trends.

Gain/loss estimates for the portion of the Pecos River intersecting the Rustler Aquifer outcrop were compiled for the years from 1952 to 2009 in Table 4.5.1 and show an average gain of 1,107 acre-feet per year. These estimates vary widely between years, however, with a standard deviation equal to 2,685 acre-feet per year. A lack of temporal data for precipitation near the outcrop precludes development of a temporal recharge distribution. Therefore, recharge and stream gain/loss in the model remain relatively constant through time. These factors allow only a qualitative comparison between simulated and estimated stream gains/losses.

Springs are assumed to constitute a significant portion of the total discharge from the Rustler Aquifer. Flowing wells may constitute a similarly large portion of the total discharge from the aquifer. Because of the scale of the model grid cells, gross averaging of elevations and local hydraulic properties occurs within the model cell. Only one flowing well (well 4634601) of the thirteen within the active model area is completed entirely within the Rustler Aquifer. Similarly, the spring with the largest discharge, Diamond Y Springs, may be fed by multiple formations (Veni, 1991; Boghici, 1997). These factors make direct comparison of simulated and observed flows in individual springs and flowing wells difficult. Instead, simulated spring flows and flowing well flows were only evaluated in a qualitative manner to ensure the simulated pre-development heads were generally above land surface.

Traditional calibration measures (Anderson and Woessner, 1992), such as the mean error, the mean absolute error, and the root mean square error, quantify the average error in the calibration process. The mean error is the mean of the differences between simulated heads (h_s) and measured heads (h_m):

$$\text{mean error} = \frac{1}{n} \sum_{i=1}^n (h_s - h_m)_i \quad (7.1.1)$$

where n is the number of calibration measurements. The mean absolute error is the mean of the absolute value of the differences between simulated heads (h_s) and measured heads (h_m):

$$\text{mean absolute error} = \frac{1}{n} \sum_{i=1}^n |(h_s - h_m)_i| \quad (7.1.2)$$

where n is the number of calibration measurements. The root mean square error is the average of the squared differences between simulated heads (h_s) and measured heads (h_m):

$$\text{root mean square error} = \left[\frac{1}{n} \sum_{i=1}^n (h_s - h_m)_i^2 \right]^{0.5} \quad (7.1.3)$$

where n is the number of calibration measurements. The difference between the measured hydraulic head and the simulated hydraulic head is termed a residual.

The mean absolute error was used as the basic calibration metric for heads. For the TWDB groundwater availability models, the required calibration criterion for heads is a mean absolute error that is equal to or less than 10 percent of the observed head range in the aquifer being simulated. To provide information on model performance with time, the mean absolute error was calculated for each year in the calibration period. The mean absolute error is useful for describing model error on an average basis but, as a single measure, it does not provide insight into spatial trends in the distribution of the residuals.

An examination of the distribution of residuals is necessary to determine if they are randomly distributed over the model grid and not spatially biased. Post plots of head residuals for both the steady-state and transient portions of the Rustler Aquifer model were used to check for spatial bias. These plots indicate the magnitude and direction of the mis-match between the observed and simulated heads. Finally, plots of simulated versus observed water-level elevations and residual versus observed water levels were used to determine if bias varies with the magnitude of the observed heads.

7.2 Calibration Target Uncertainty

Calibration targets are uncertain. In order to not “over-calibrate” a model, which is a stated desire for the groundwater availability models, the calibration criteria should be defined consistently with the uncertainty in calibration targets. Uncertainty in head measurements can be the result of many factors including measurement errors, scale errors, and various types of averaging errors that are both spatial and temporal. The primary calibration criteria for head is a

mean absolute error less than or equal to 10 percent of the observed head variation within the aquifer being modeled. The range in the observed water levels across the Rustler Aquifer in the study area is 1,171 feet during steady-state and 1,794 feet during transient conditions. This leads to acceptable mean absolute errors of 171 feet and 179 feet for the steady-state and transient models, respectively. Comparison of this mean absolute error to an estimate of the head target errors indicates what level of calibration the underlying head targets can support.

Water-level measurement errors are typically on the order of tenths of feet and, at the groundwater availability model scale, can be considered insignificant. However, measuring-point elevation errors can be significant. The error (standard deviation) in averaging ground surface elevations from a 30 meter DEM to quarter-mile by quarter-mile model grid cells averages 14 feet within the Rustler Aquifer outcrop. Another error is caused by combining multiple aquifer textures (i.e., sediment types) into quarter-mile by quarter-mile grid blocks represented by one simulated head. No coincident (within the same grid block) water levels are available with which to assess this error mechanism, however. When these errors are added together, the average error in model heads could easily equal 30 to 40 feet. Calibrating to mean absolute error values significantly less than 40 feet would constitute over-calibration of the model and parameter adjustments to reach that mean absolute error are not supported by the hydraulic head uncertainty.

The pre-development water-level measurements are discussed in Section 4.3.2. Although some pre-development water-level measurements exist within the Rustler Aquifer outside the active model area, no water-level measurements are available prior to groundwater development within the active model area. To provide an estimate of the pre-development heads, the maximum observed water level observed in a given well was used. This allows calibration of the steady-state model to different hydrologic conditions than those of the transient model, however, it is expected that these water-level measurements are biased low compared to true pre-development conditions. As a result, a steady-state calibration state that is biased high rather than low in terms of simulated heads was favored.

7.3 Conceptual Model Uncertainty

The conceptual model of nearly any hydrogeologic system has aspects that are uncertain. This is especially true the greater the complexity of the aquifer system. Section 4 has detailed the conceptual model for the Rustler Aquifer which is very complex, especially with respect to model structure and model boundaries. In an ideal framework, each uncertain aspect of the conceptual model would be reviewed and several alternative conceptualizations may be carried forward for independent calibration. This ideal framework is beyond the scope of the current study. However, several aspects of the aquifer conceptual model related to model boundaries were considered particularly uncertain and amenable to inspection and exploration during the model calibration phase. Specifically, uncertainty regarding inflow from the Glass Mountains (Boundary H in Figure 6.3.1), possible cross-formational flow from the Capitan Reef Complex Aquifer, inflow from the Davis Mountains (Boundary G in Figure 6.3.1), the boundary along the halite line in New Mexico (Boundary B in Figure 6.3.1), and the easternmost boundary (Boundary F in Figure 6.3.1) are discussed in this section.

Recharge from the Glass Mountains is believed to provide inflow into the Rustler Aquifer in subdomains 5 and 4B. This inflow may occur as lateral flow into the southeastern model boundary, as vertical inflow from underlying units, or some combination of both of these mechanisms. In the case of lateral inflow, it may result from cross-formational flow that occurs outside the active model area and originates from the Tessey Limestone, the Capitan Reef Complex Aquifer, or both.

If the cross-formational flow occurs outside the boundary, it can be represented in the numerical model by a prescribed flow boundary condition. The total inflow rate can be constrained somewhat as a percentage of the precipitation on the Tessey Limestone and Capitan Reef Complex Aquifer outcrops. Transmissivity weighting can be used to distribute the inflow locally along the boundary.

Vertical inflow may result from cross-formational flow from the portion of the Capitan Reef Complex Aquifer that underlies the Rustler Aquifer within the active model area. In this case, the areal distribution of flow could have a large impact on the simulated head surfaces within the Rustler Aquifer. Because the areal distribution of inflow is unknown, this boundary would be best represented by an additional model layer with a general-head boundary condition

representing the Capitan heads. Implementation of general-head boundary conditions requires specifying conductances and heads in pre-development and at each of the simulated stress periods. Although estimates of pre-development heads are available (Hiss, 1975), heads for the entire transient period are not available. The vertical hydraulic conductivity of the Capitan Reef Complex Aquifer, which governs the general-head boundary conductance, is also poorly characterized. Incorporation of an additional model layer requires developing hydrostratigraphy of a very complex interval between the base of the Rustler Aquifer and the top of the Capitan Reef Complex. This lack of key data means that attempting to account for the cross-formational flow from the Capitan Reef Complex would actually add to the uncertainty in the model. As a result, we kept the lower boundary of the Rustler Aquifer as a no-flow boundary recognizing that this assumption is less valid in certain areas of the model domain.

Recharge from the Davis Mountains may enter the Rustler Aquifer from the southwest. This flow crosses the Stocks Fault/Rounsaville Syncline which forms the southwestern boundary of the model. Sharp and others (2003) provided evidence that regional flow could be occurring in a regional carbonate system from Wildhorse Flatt into the Toyah Basin. Because of the significant offset of the Rustler Aquifer along the fault, connectivity for flow is expected to be limited. This boundary was investigated through simulation both as a no-flow boundary condition and as a prescribed flow boundary condition.

The northeastern boundary coincides with the halite line, north of which the hydraulic conductivity of the Rustler Aquifer is very low. This boundary was simulated alternately as no-flow boundary or a general-head boundary. The heads for a general-head boundary can be inferred from water-level data collected in New Mexico (Bowman, 2010) but these data are not located very near the halite line. Because of this uncertainty and because the halite line runs parallel to the general flow direction from recharge inflow in the Rustler Aquifer outcrop, a no-flow boundary is considered the more representative boundary condition.

The easternmost boundary of the model coincides with the 2,000-foot structure contour line of the top of the Rustler Aquifer. It does not correspond to any true hydrogeologic boundary and is relatively uncertain. This boundary was simulated both as a no-flow, distance boundary condition and as a general-head boundary condition. Because no proximal data exists by which to set the general-head boundary heads, and the simulated water levels are sensitive to the

boundary head, this type of boundary condition adds possible error to the model. Additionally, because little if any flow is thought to enter or leave this boundary, a no-flow, distance boundary is considered the preferable option.

7.4 Sensitivity Analysis

A sensitivity analysis was performed on the steady-state and transient calibrated models to determine the impact of changes in a calibrated parameter on the predictions of the calibrated model. A standard “one-off” sensitivity analysis was performed. This means that hydraulic parameters or stresses were adjusted from their calibrated “base case” values one by one while all other hydraulic parameters remained unperturbed.

8.0 Steady-State Model

The steady-state model developed for the Rustler Aquifer represents a predevelopment period when water levels in the aquifer are assumed to be constant owing to an assumed long-term equilibrium between aquifer recharge and natural aquifer discharge. This section details calibration of the steady-state model and presents the steady-state model results. The sensitivity of the steady-state model to various hydrologic parameters is also described.

8.1 Calibration

This section describes the steady-state calibration targets and potential calibration parameters including horizontal and vertical hydraulic conductivity, recharge, evapotranspiration, general-head boundaries, and stream conductance.

8.1.1 Calibration Targets

Water-level measurements are needed as targets for steady-state calibration. Selection of water-level measurements representative of steady-state conditions was discussed in Section 4.3.2. Steady-state targets included water-level measurements from 47 well locations in the Rustler Aquifer.

8.1.2 Horizontal and Vertical Hydraulic Conductivities

Section 6.4.1 described the determination of initial horizontal and vertical hydraulic conductivities for the model. Figure 8.1.1 depicts the final calibrated horizontal hydraulic conductivity fields for the Rustler Aquifer. The main changes to the horizontal hydraulic conductivity involved the removal of the depth-decay model from subdomains 4B and 5. A maximum horizontal hydraulic conductivity of 5 feet per day was used in the calibrated model. In structural subdomain 4B, productivities of individual wells associated with suspected fractures or karst features are known to be very significant and would likely possess hydraulic conductivities in excess of 5 feet per day. However, the scale and location of these features are unknown and cannot be discretely defined in the model. These high transmissivity regions are relatively discrete in area relative to a quarter-mile by quarter-mile grid cell that has a massive cross-sectional area and behaves with an effective wellbore radius of 275 feet. As a result of these scale issues, 5 feet per day was considered to be a reasonable upper limit to hydraulic

conductivity. The corresponding transmissivity distribution within the Rustler Aquifer is shown in Figure 8.1.2.

In the steady-state model, vertical leakage of groundwater from layer 1 to layer 2 is controlled primarily by the vertical conductivity of layer 1, which represents the Dewey Lake and Dockum formations and, to a lesser degree, the vertical conductivity of layer 2, which represents the Rustler Aquifer. A vertical anisotropy of horizontal hydraulic conductivity being 1,000 times greater than the vertical conductivity was maintained during model calibration. Changes to the horizontal conductivity during calibration resulted in corresponding changes to the vertical conductivity, however. The final, calibrated vertical hydraulic conductivities for the Rustler Aquifer are shown in Figure 8.1.3.

8.1.3 Recharge and Groundwater Evapotranspiration

Recharge in the outcrop of the steady-state model was based on a percentage (1 percent) of average annual precipitation and its implementation is discussed in Section 6.3.4. Altering recharge and hydraulic conductivity concurrently leads to inherently non-unique calibrations (Castro and Goblet, 2003). Furthermore, using data to constrain recharge has been demonstrated to be more efficient at stabilizing the groundwater inverse problem than constraining conductivity values when calibrating primarily to hydraulic head data (Weiss and Smith, 1998). For these reasons, recharge in the outcrop was not altered during the calibration process.

The conceptual model also considered lateral aquifer recharge (inflow) at the active model boundaries from the Glass Mountains in south Pecos and north Brewster counties and from the Davis Mountains at the boundary of Jeff Davis and Reeves and Pecos counties. The inflows from the Glass and Davis mountains are more indirectly related to precipitation and are more unknown. The lateral inflow from the Davis Mountains was initially set to zero and was increased to a total of 637 acre-feet per year during calibration to increase heads within the outcrop in the vicinity of the boundary. Because only a few water-level observations are affected by this boundary, the model as a whole is relatively insensitive to changes in the magnitude of this inflow mechanism. The lateral inflow from the Glass Mountains has more of an impact on the observed water levels in subdomain 4B. This value was increased from the initial value of 1,800 acre-feet per year to a total inflow of 2,600 acre-feet per year, equivalent to approximately

10 percent of the estimated recharge to the Tessey Formation outcrop, to better match observed heads in subdomain 4B.

The implementation of evapotranspiration is discussed in Section 6.3.4. Evapotranspiration occurs only within the outcrop of the Rustler Aquifer, which comprises only a small portion of the aquifer area. In addition, only five of the 47 steady-state water level measurements lie in the Rustler Aquifer outcrop in the vicinity of the evapotranspiration cells. Sensitivity analyses indicated that the simulated water levels in the aquifer were relatively insensitive to variations in the evapotranspiration parameters when compared to other model parameters. Accordingly, the evapotranspiration parameters controlling evapotranspiration rates were unaltered during the calibration process.

8.1.4 General-Head Boundaries

The heads in the general-head boundaries in layer 1 were estimated based on a combination of measurements in the Edwards-Trinity (Plateau) and Pecos Valley aquifers and simulated heads from the Edwards-Trinity (Plateau) and Pecos Valley aquifers GAM as discussed in Section 6.3.2. The general-head boundary conductances were based on the estimated vertical hydraulic conductivities of the Dewey Lake and Dockum formations. The conductance of the general-head boundaries was uniformly reduced by a factor of ten during the calibration process to better match the observed water levels within the Rustler Aquifer. The initial estimates of hydraulic conductivity for layer 1 were based on estimates of the Dockum Aquifer (see Section 6.4.1). The Dewey Lake Formation is conceptualized to be of lower conductivity than the Dockum Aquifer, however. Therefore, this conductance decrease is in keeping with the conceptual model.

8.1.5 Stream Conductances

Only the Pecos River presents a perennial stream within the Rustler Aquifer footprint. Furthermore, only a small portion of the Rustler Aquifer is in direct contact with the Pecos River. Larger portions of the Pecos River contact overlying formations and interact indirectly with the Rustler Aquifer. No water-level measurements exist in the vicinity of the portion of the Pecos River that directly contacts the Rustler Aquifer. Gain/loss estimates for this portion of the Pecos River were compiled in Table 4.5.1. Because of the minor extent of the connection between the Pecos River and the Rustler Aquifer as a whole, this interaction was implemented as a general-

Final Groundwater Availability Model for the Rustler Aquifer

head boundary condition rather than using the stream-flow routing package. These parameters were not altered during the model calibration process because the simulated gain is within one third of one standard deviation of the average gain observed in the gain/loss estimates through this reach.

Final Groundwater Availability Model for the Rustler Aquifer

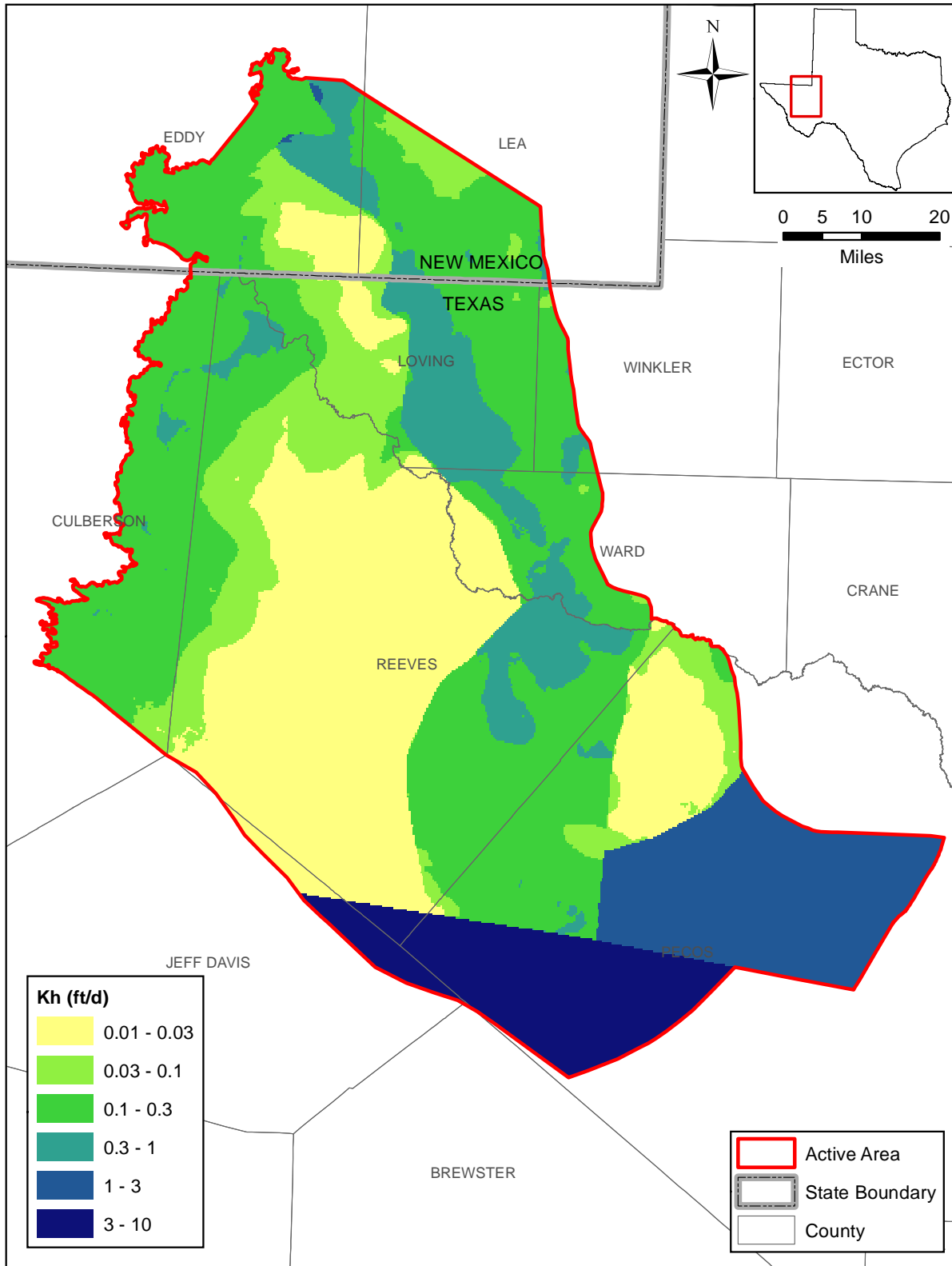

Figure 8.1.1 Calibrated horizontal hydraulic conductivity (Kh) in feet per day for the Rustler Aquifer.

Final Groundwater Availability Model for the Rustler Aquifer

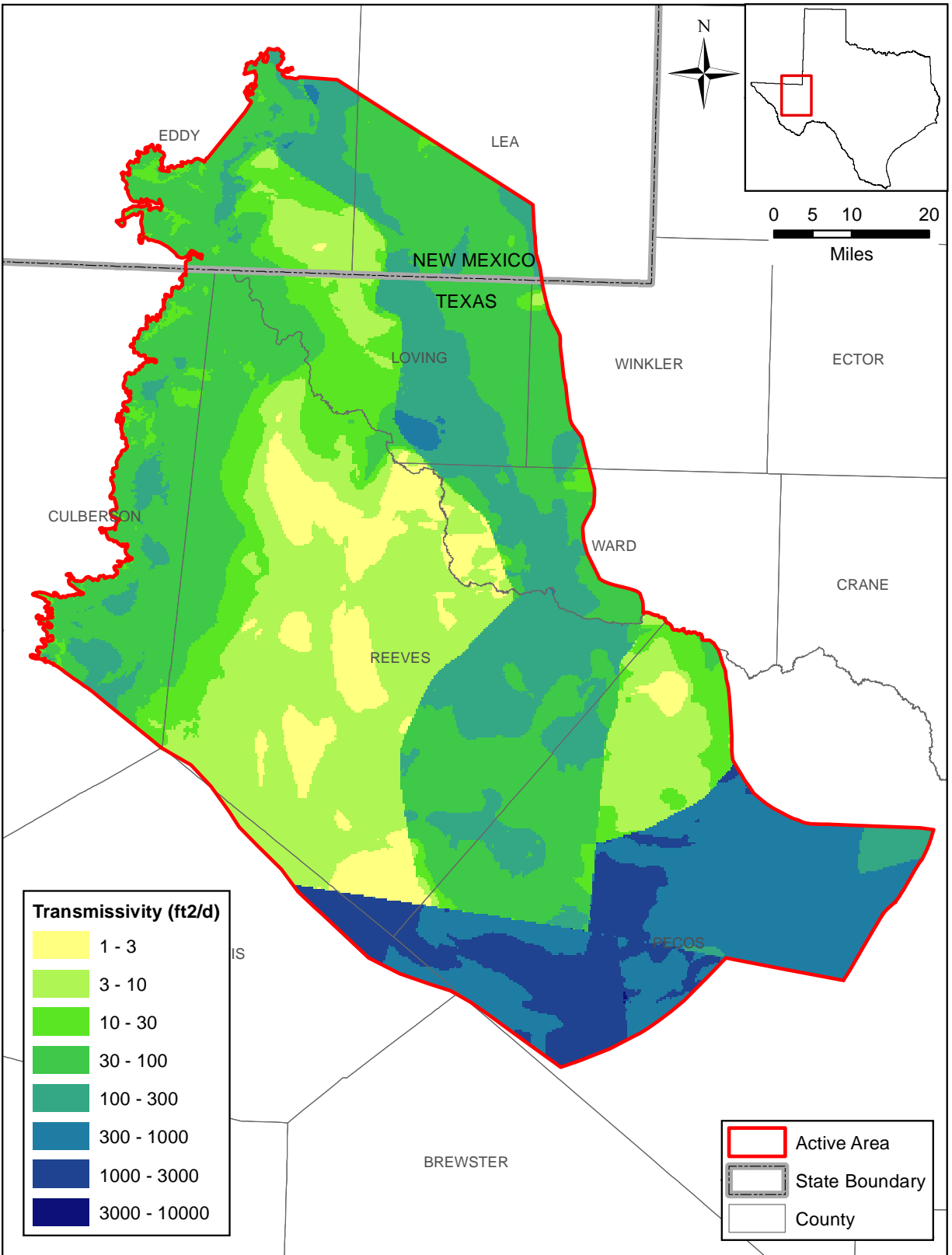

Figure 8.1.2 Calibrated transmissivity in feet squared per day for the Rustler Aquifer.

Final Groundwater Availability Model for the Rustler Aquifer

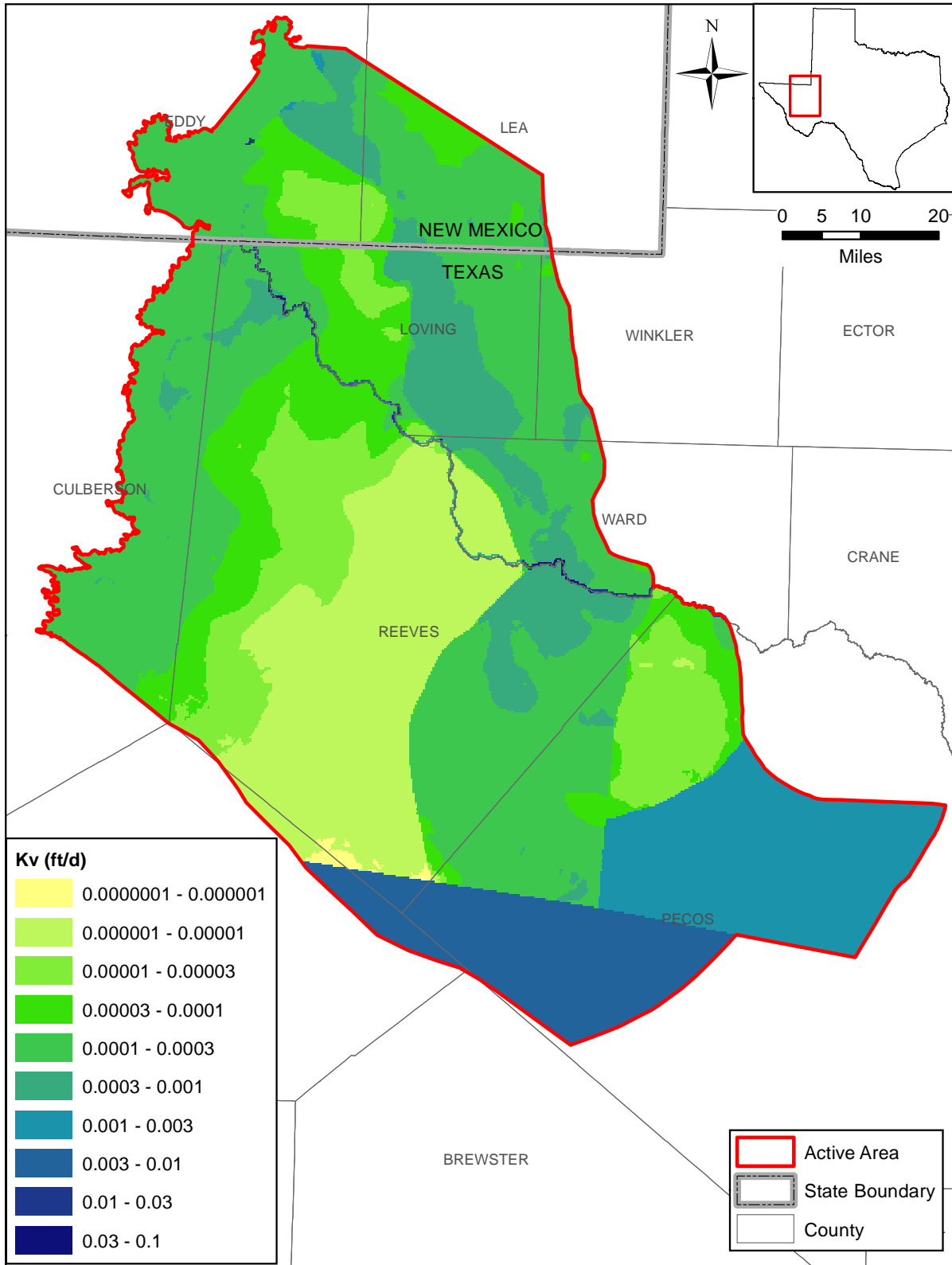

Figure 8.1.3 Calibrated vertical hydraulic conductivity (Kv) in feet per day for the Rustler Aquifer.

Final Groundwater Availability Model for the Rustler Aquifer

This page intentionally left blank.

8.2 Simulation Results

Calibration of the steady-state model is not unique. Calibrated results can be obtained by numerous combinations of recharge and vertical and horizontal hydraulic conductivities. Apart from the general-head boundary heads, which were constrained by water-level measurements in the Edwards-Trinity (Plateau) and Pecos Valley aquifers and were not adjusted during calibration, the steady-state model is most sensitive to the horizontal hydraulic conductivity of the Rustler Aquifer. This is to be expected, since the horizontal hydraulic conductivity in the Rustler Aquifer provides resistance between the inflow boundary conditions and the discharge avenues associated with pumping, evapotranspiration, streams, flowing wells, and springs.

8.2.1 Water-Level Elevation

A comparison of simulated and observed water levels and residuals versus observed water levels for the Rustler Aquifer are shown in Figure 8.2.1 by structural subdomain, where residuals are defined as:

$$\text{residual} = \text{head}_{\text{simulated}} - \text{head}_{\text{measured}} \quad (8.2.1)$$

A positive residual indicates that the model has overpredicted the hydraulic head, while a negative residual indicates underprediction. Residuals range from -56 to 233 feet with 94 percent falling between -100 and 100 feet. The residuals for the Rustler Aquifer are unequally split between underpredicting (30 percent) and overpredicting (70 percent) observed values, indicating an overall high bias in the residuals. The steady-state model is assumed to represent predevelopment conditions which would have no pumping. Since no true predevelopment water-level measurements exist, the maximum measurement was used for the steady-state targets. In many cases, some unknown amount of pumping and associated water-level decline has occurred prior to the water-level measurements. This leads to a low bias in the measurements with an associated high bias in the residuals. For these reasons, the steady-state calibration has a high bias with respect to head residuals.

Figure 8.2.2 shows the simulated water-level elevations in the Rustler Aquifer. This figure shows a general northwest to southeast groundwater gradient following the dip in the Rustler Aquifer structure. Simulated water levels exhibit discontinuity at the faults with large displacement, demonstrating the effect of the horizontal flow barrier package to simulate the

hydraulic barriers formed by these faults. Post plots of residuals are also included on Figure 8.2.2. Although the majority of the residuals are positive, negative residuals tend to be interspersed within the positive ones, indicating no obvious bias in the locations of the residuals.

The calibration statistics for the Rustler Aquifer are summarized in Table 8.2.1. The adjusted mean absolute error (i.e., mean absolute error divided by the range in observed water levels) is 3.2 percent for of the Rustler Aquifer. The mean error for the steady-state model is 43.6 feet, likely reflecting, at least in part, the low bias in the water level measurements used as predevelopment targets.

Because the model did not use convertible layers as discussed in Sections 6.2 and 6.3.4, none of the layers went dry and all active cells remained active during the simulations. A comparison of the simulated steady-state heads with the basal elevation of the Rustler Aquifer shows that 0.7 percent of the cells had heads below the base of the aquifer. This occurs primarily in the eastern portion of the Rustler Aquifer outcrop where simulated heads tend to be systematically higher than observed heads (see Figure 8.2.2) and where many of the cells are set to the minimum thickness of 100 feet. Therefore, the would-be dry cells are likely caused by uncertainty in the Rustler Aquifer structure in the outcrop.

8.2.2 Streams, Springs, and Evapotranspiration

The simulated stream gain/loss for the segment of the Pecos River in contact with the Rustler Aquifer outcrop (Figure 8.2.3) amounts to a gain of 256 acre-feet per year. Stream gain/loss estimates for the years from 1952 through 2009 average a gain of 1,107 acre-feet per year. These estimates vary widely with a standard deviation equal to 2,685 acre-feet per year. The simulated steady-state gain is considered consistent with the range of estimates and within one third of one standard deviation from the average of the estimates. Because of the high variability in the gain/loss estimates in this reach, the general-head boundary conductances representing the Pecos River were not adjusted during calibration.

The simulated discharge at springs is shown in Figure 8.2.4. The largest spring flow in the Rustler Aquifer occurs at Diamond Y Springs with a pre-development flow rate of 981 acre-feet per year. This is not dissimilar from the maximum observed flow at Diamond Y Springs of 1,049 acre-feet per year. As discussed in Section 7.1, there is some uncertainty as to the origins

of Diamond Y Springs with some concluding that the dominant aquifer source is the Rustler Aquifer (Boghici, 1997) and others concluding that the spring complex is fed partially by the Capitan Reef Complex Aquifer. It is likely that the fault system feeding the spring connects multiple potential aquifers. Without knowledge of the percent of contribution to the spring flow from the Rustler Aquifer, direct comparison of simulated flows to observed spring flows is limited in meaning. For the other springs being fed in part by the Rustler Aquifer, the localized drainage system and geometry of the springs are likely at a scale considerably smaller than that which the model can feasibly simulate. This hinders quantitative comparison between simulated and observed spring flows. In a similar sense, only one of the 13 flowing wells was completed entirely within the Rustler Aquifer, precluding a quantitative comparison between simulated and observed flowing well flows. Accordingly, no attempt to match spring or flowing well flows was made during calibration. Qualitatively, the simulated head should be above land surface at the spring and flowing well locations during the predevelopment period, however.

Figure 8.2.5 shows the simulated head at each of the springs and flowing wells in relation to the land surface elevation. Six out of the eight springs (including Diamond Y Springs) exhibit artesian conditions. The simulated head at unnamed springs in the northernmost corner of Reeves County is 11 feet below the average land surface elevation in the cell, within the error of the spring elevation. The simulated head at Hurd Springs in Culberson County, on the other hand, is 251 below land surface. Numerous water-level measurements in the vicinity of Hurd Springs show systematically positive residuals (see Figure 8.2.2) indicating that simulated heads tend to be high in that region. This indicates that the conditions at Hurd Springs are inconsistent with numerous water-level measurements. Seven out of the eight flowing wells in subdomain 4B exhibit artesian conditions with only well P-134 having a simulated head below (18 feet) land surface. Three of the five flowing wells in subdomain 4A have simulated heads between 10 and 30 feet below land surface and two of the wells have simulated heads between 30 and 100 feet below land surface.

The simulated evapotranspiration discharge for the steady-state model is shown in Figure 8.2.6. Evapotranspiration occurs in 271 of the 1,430 riparian cells with the maximum simulated rate equivalent to 10 inches per year. These evapotranspiration rates tend to be considerably less than

the calculated maximum evapotranspiration rates, which range from 39 to 45 inches per year as discussed in Section 6.3.4. This is to be expected for a groundwater evapotranspiration rate.

8.2.3 Cross-Formational Flow

The simulated cross-formational flow from the Rustler Aquifer through the Dewey Lake Formation and Dockum Aquifer into the Edwards-Trinity (Plateau) and Pecos Valley aquifers is depicted in Figure 8.2.7. This figure indicates that the majority of the Rustler Aquifer exhibits diffuse upward cross-formational flow to the Edwards-Trinity (Plateau) and Pecos Valley aquifers. Across the majority of the aquifer, very small cross-formational flow of less than 0.1 inches per year is simulated, with the higher flow rates occurring at the edges of layer 1 near recharge zones.

8.2.4 Water Budget

Tables 8.2.2 and 8.2.3 summarize the water budget for the steady-state model in terms of total volume and as a percentage of total inflow. The overall mass balance error for the steady-state simulation was -0.02 percent in the MODFLOW list output, well under the groundwater availability model requirement of one percent. The net inflow to the Rustler Aquifer totals 7,133 acre-feet per year. The predominant sources of inflow to the Rustler Aquifer are direct recharge from the Rustler Aquifer outcrop (55 percent of net inflow) and indirect recharge (lateral inflow boundary) from the Glass and Davis mountains (45 percent of net inflow). Water discharges the Rustler Aquifer through net upward cross-formational flow to the Edwards-Trinity (Plateau) and Pecos Valley aquifers (66 percent of net inflow), springs (16 percent of net inflow), evapotranspiration (14 percent of net inflow), and streams (4 percent of net inflow). While the cross-formational flow constitutes a large portion of the discharge from the Rustler Aquifer, it occurs through diffuse flow over the entire Rustler Aquifer subcrop and is equivalent to only 0.013 inches per year, more than an order of magnitude less than direct recharge on a unit area basis. The steady-state water budgets for the Rustler Aquifer by county and by Groundwater Conservation District are summarized in Tables 8.2.4 and 8.2.5, respectively. In these tables, cross-formational flow represents vertical flow between model layers (formations) and lateral flow represents flow within a model layer (formation). Any cross-formational flow that may occur between formations at faults is not accounted for in the numerical model nor in the water budgets summarized in Tables 8.2.4 and 8.2.5.

Final Groundwater Availability Model for the Rustler Aquifer

Table 8.2.1 Calibration statistics for the steady-state model.

Aquifer	Number	ME (feet)	MAE (feet)	RMS (feet)	Range (feet)	Adjusted MAE
Rustler	47	43.6	55.1	74.6	1,711	0.032

ME = mean error

MAE = mean absolute error

RMS = root mean square

Table 8.2.2 Water budget for the steady-state model (all rates reported in acre-feet per year).

Layer	Cross-Formational Flow	Recharge	Lateral Flow	Springs	ET	GHBs	Streams
1	4,697	0	0	0	0	-4,697	0
2	-4,697	3,896	3,237	-1,176	-1,008	0	-256
Sum	0	3,896	3,237	-1,176	-1,008	-4,697	-256

GHBs = general-head boundaries

ET = evapotranspiration

Table 8.2.3 Water budget for the steady-state model with values expressed as a percentage of total inflow.

Layer	Cross-Formational Flow	Recharge	Lateral Flow	Springs	ET	GHBs	Streams
1	66%	0%	0%	0%	0%	-66%	0%
2	-66%	55%	45%	-16%	-14%	0%	-4%
Sum	0%	55%	45%	-16%	-14%	-66%	-4%

GHBs = general-head boundaries

ET = evapotranspiration

Table 8.2.4 Steady-state water budget in the Rustler Aquifer by county (all rates reported in acre-feet per year).

County	State	Cross-Formational Flow	Recharge	Lateral Flow	Springs	ET	Streams
Andrews	TX	0	0	0	0	0	0
Brewster	TX	0	0	8	0	0	0
Crane	TX	0	0	0	0	0	0
Culberson	TX	-1,770	2,561	208	-195	-88	0
Ector	TX	0	0	0	0	0	0
Eddy	NM	-118	1,188	0	0	-715	-256
Jeff Davis	TX	257	0	255	0	0	0
Lea	NM	42	0	0	0	0	0
Loving	TX	-254	0	0	0	0	0
Pecos	TX	-1,910	0	2,761	-981	0	0
Presidio	TX	0	0	0	0	0	0
Reeves	TX	-885	147	5	0	-204	0
Ward	TX	-85	0	0	0	0	0
Winkler	TX	26	0	0	0	0	0

ET = evapotranspiration

TX = Texas

NM = New Mexico

Final Groundwater Availability Model for the Rustler Aquifer

Table 8.2.5 Steady-state water budget in the Rustler Aquifer by Groundwater Conservation District (all rates reported in acre-feet per year).

GCD	Cross-Formational Flow	Recharge	Lateral Flow	Springs	ET	Streams
Jeff Davis County UWCD	257	0	255	0	0	0
Middle Pecos GCD	-1,910	0	2,761	-981	0	0
No GCD	-3,044	3,896	221	-195	-1,008	-256

ET = evapotranspiration

GCD = Groundwater Conservation District

UWCD = Underground Water Conservation District

Final Groundwater Availability Model for the Rustler Aquifer

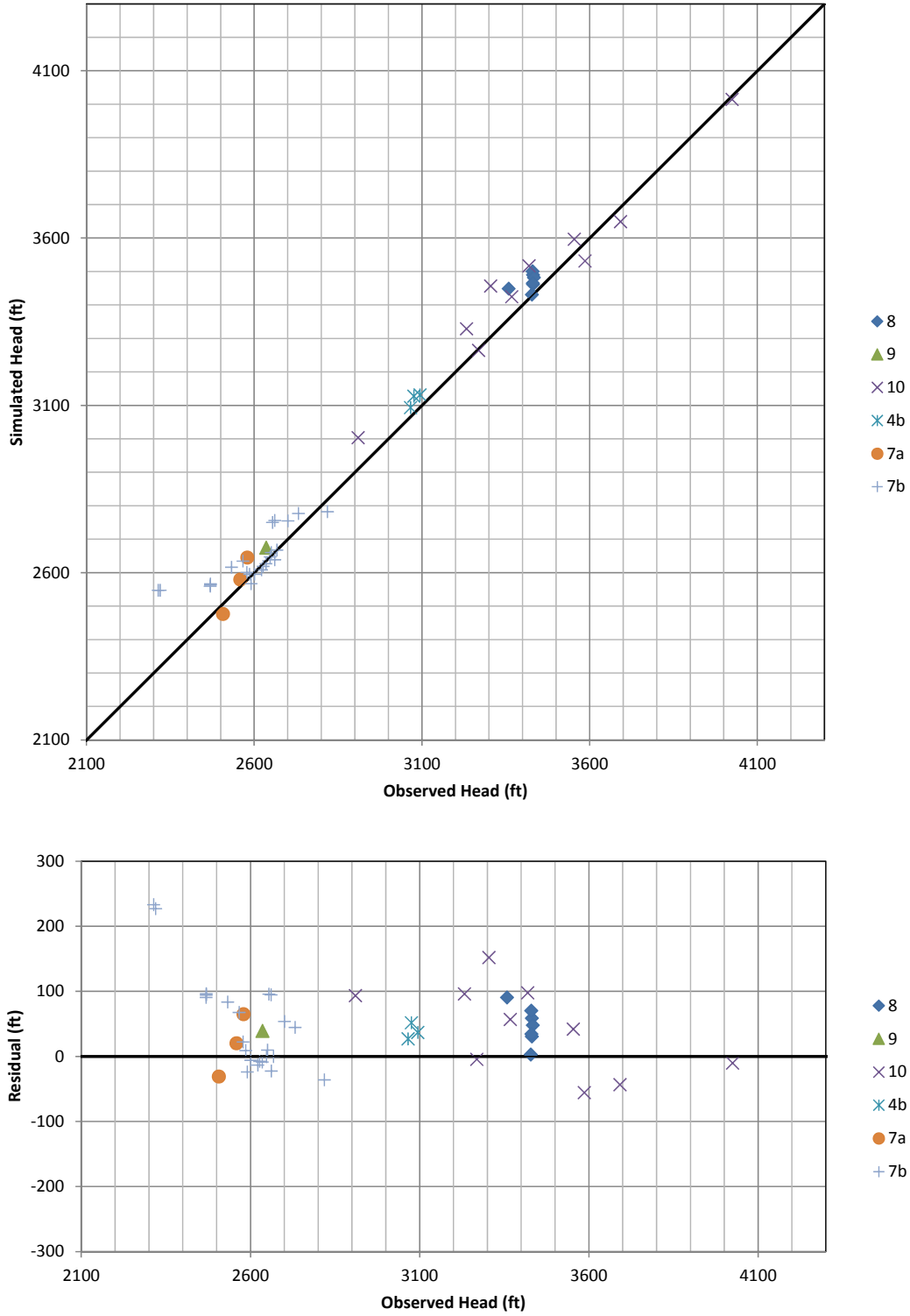

Figure 8.2.1 Plots of (a) simulated versus observed water-level elevations in feet and (b) residual versus observed water-level elevation in feet for the Rustler Aquifer in the steady-state model by hydrostructural subdomain.

Final Groundwater Availability Model for the Rustler Aquifer

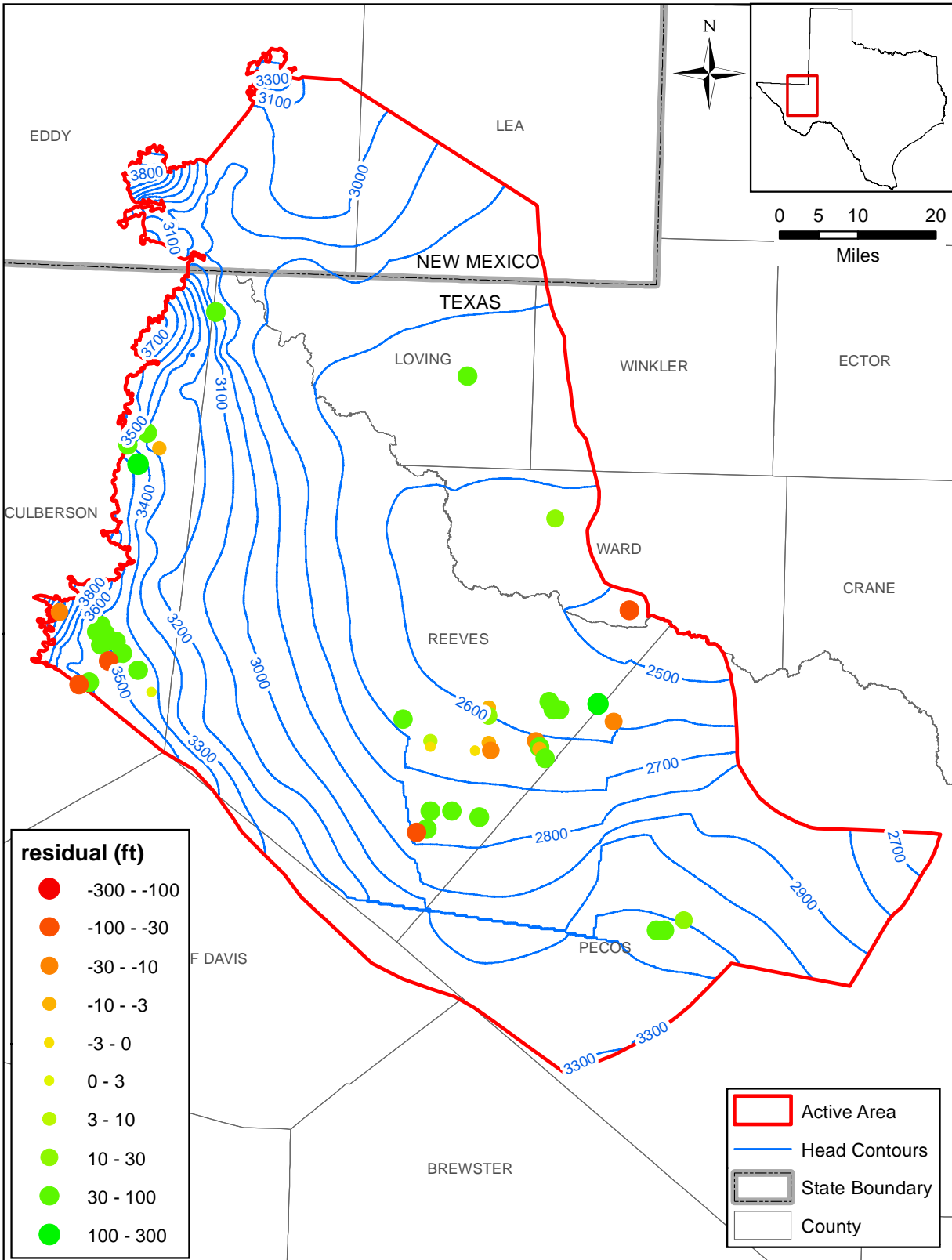

Figure 8.2.2 Simulated steady-state water levels and residuals in feet for the Rustler Aquifer.

Final Groundwater Availability Model for the Rustler Aquifer

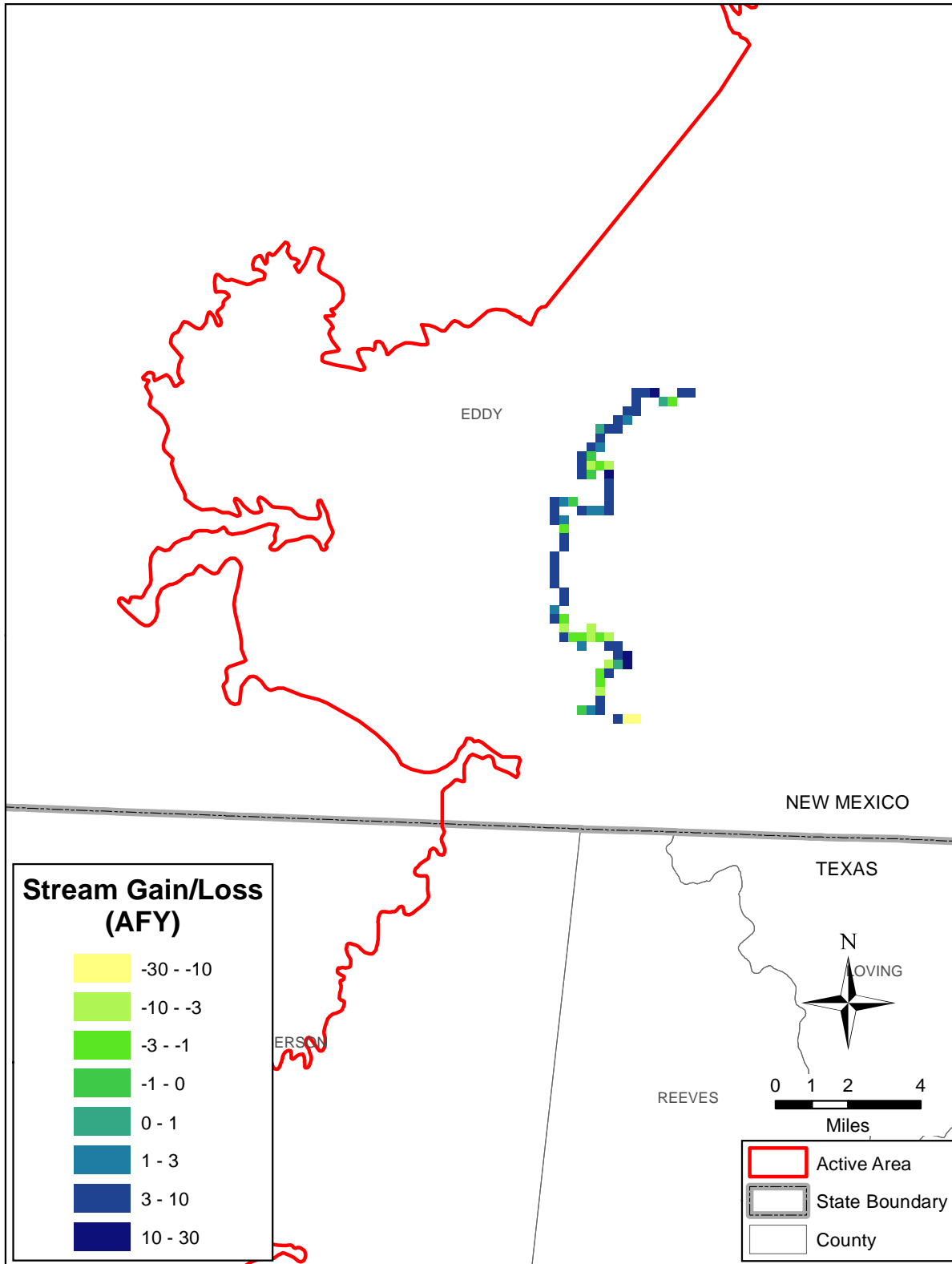

Figure 8.2.3 Steady-state model stream gain/loss in acre-feet per year (negative values denote gaining streams).

Final Groundwater Availability Model for the Rustler Aquifer

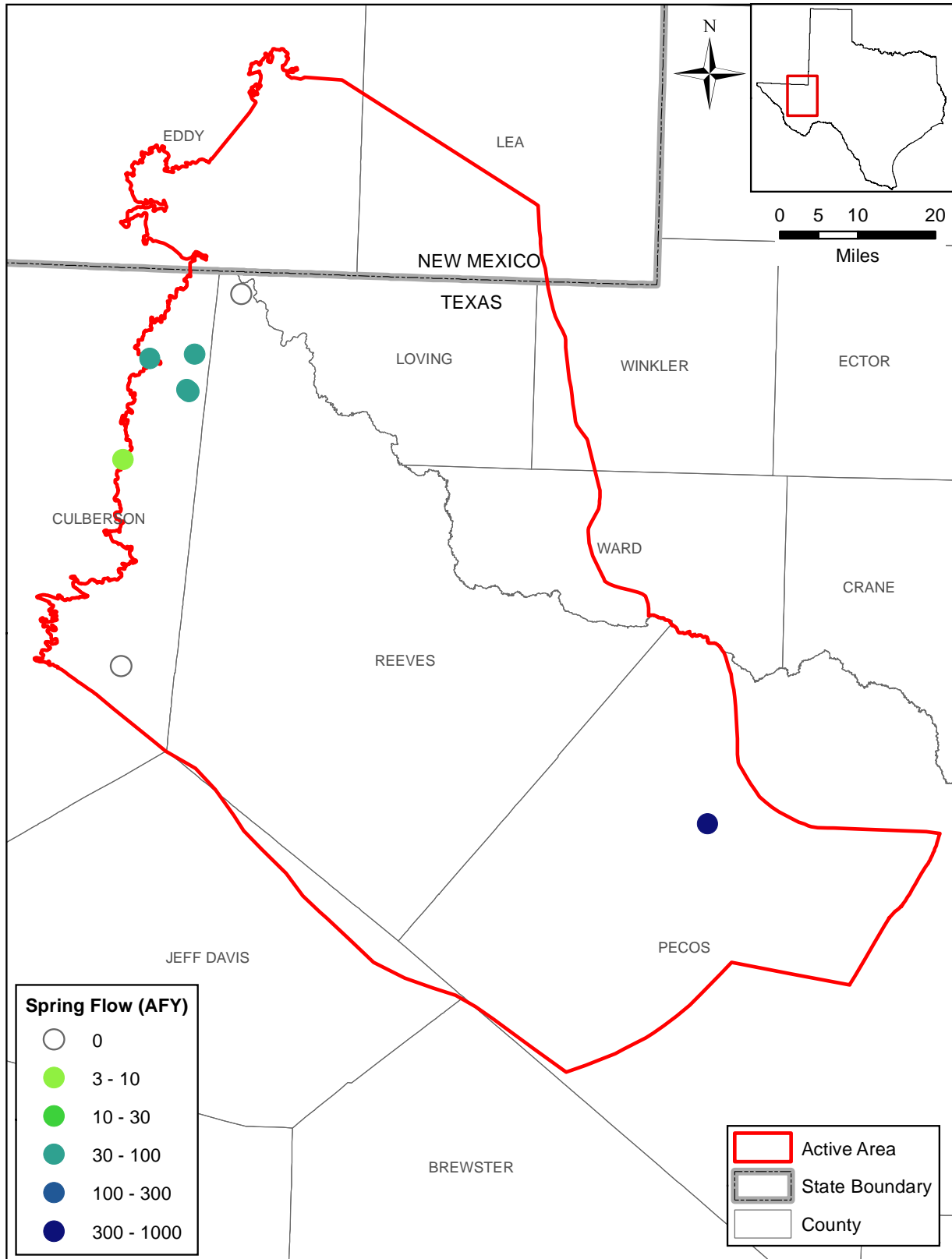
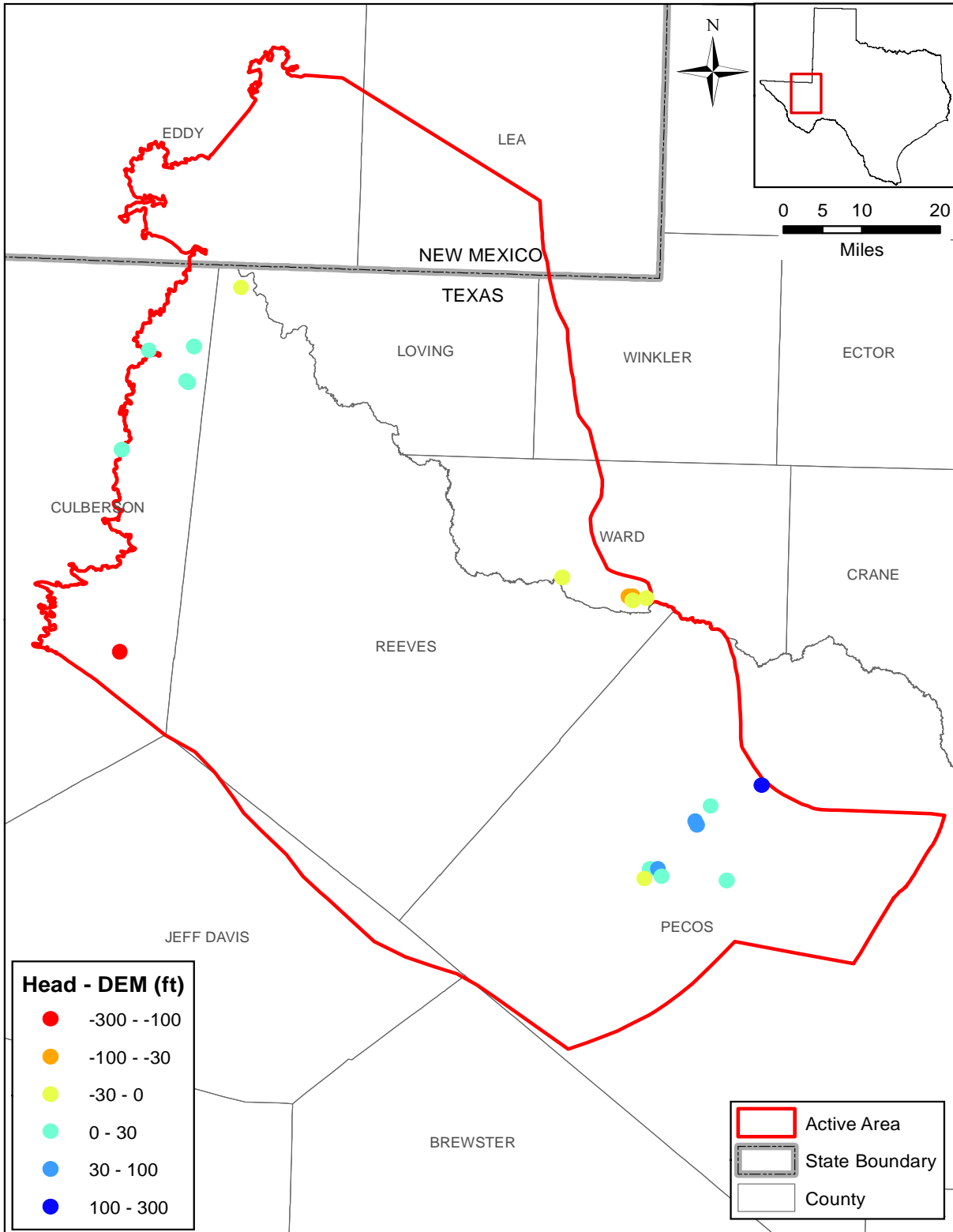

Figure 8.2.4 Simulated spring flow rates in acre-feet per year in the steady-state model.

Final Groundwater Availability Model for the Rustler Aquifer



DEM = digital elevation model

Figure 8.2.5 Simulated head in relation to land-surface elevation at springs and flowing wells in the steady-state model.

Final Groundwater Availability Model for the Rustler Aquifer

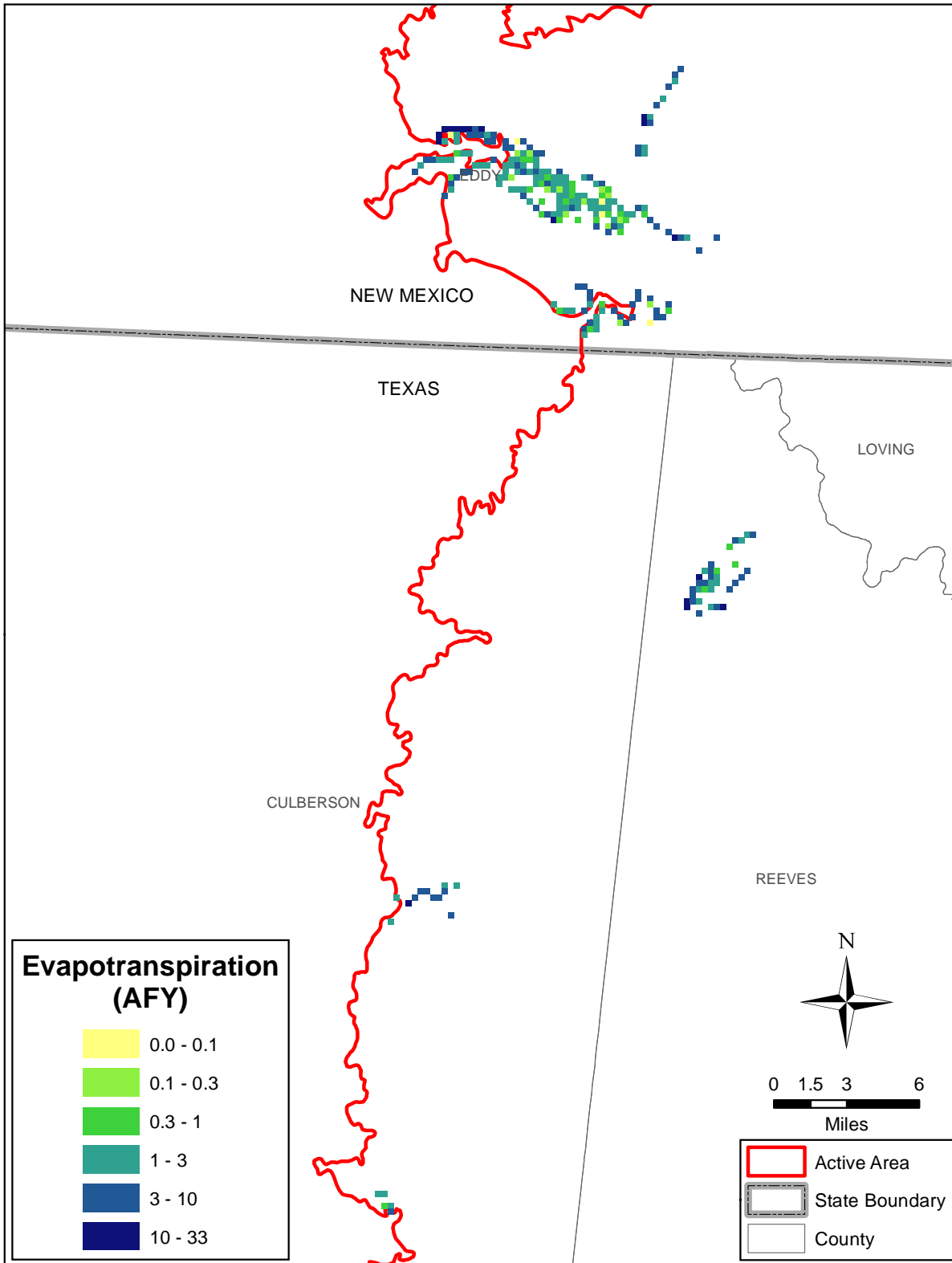

Figure 8.2.6 Simulated evapotranspiration discharge in acre-feet per year for the steady-state model.

Final Groundwater Availability Model for the Rustler Aquifer

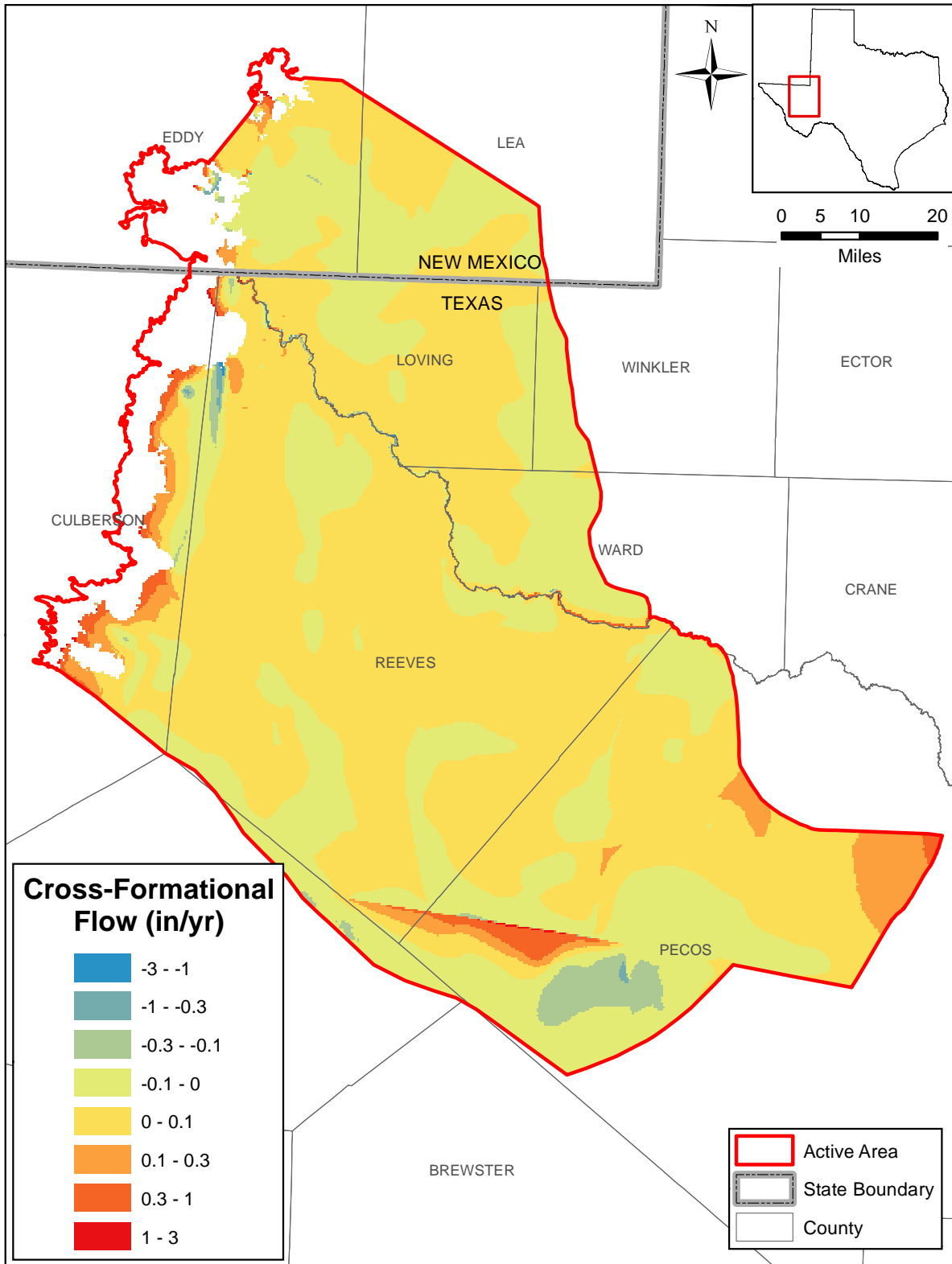

Figure 8.2.7 Simulated cross-formational flow to overlying aquifers in acre-ft per year (positive value denotes flow from the Rustler Aquifer).

This page intentionally left blank.

8.3 Sensitivity Analysis

A sensitivity analysis was performed on the calibrated steady-state model. A sensitivity analysis provides a means of formally describing the impact of varying specific parameters or groups of parameters on model outputs. In this sensitivity analysis, input parameters were systematically increased and decreased from their calibrated values while the change in water-level elevation and outflows was recorded. Four simulations were completed for each parameter sensitivity, where the input parameters were varied either according to:

$$(\text{new parameter}) = (\text{old parameter}) * \text{factor} \quad (8.3.1)$$

or

$$(\text{new parameter}) = (\text{old parameter}) * 10^{(\text{factor} - 1)} \quad (8.3.2)$$

or

$$(\text{new parameter}) = (\text{old parameter}) + (\text{factor} * 40) \quad (8.3.3)$$

and the factors were 0.5, 0.9, 1.1, and 1.5. Parameters such as recharge were varied linearly using Equation 8.3.1. For parameters such as hydraulic conductivity, which are typically thought of as log-varying, Equation 8.3.2 was used. For parameters involving elevation changes in boundary conditions, Equation 8.3.3 was used. For the output variable, the mean difference (MD) between the base simulated head and the sensitivity simulated head was calculated as:

$$MD = \frac{1}{n} \sum_{i=1}^n (h_{sens,i} - h_{cal,i}) \quad (8.3.4)$$

where $h_{sens,i}$ is the sensitivity simulation head at active gridblock i , $h_{cal,i}$ is the calibrated simulation head at active gridblock i , and n is the number of active gridblocks.

For the steady-state sensitivity analysis, fifteen parameter sensitivities were investigated:

1. Horizontal hydraulic conductivity of all layers (Khall),
2. Horizontal hydraulic conductivity of layer 1 (Kh1),
3. Horizontal hydraulic conductivity of layer 2 (Kh2),
4. Vertical hydraulic conductivity of all layers (Kvall),

5. Vertical hydraulic conductivity in layer 1 (K_{v1}),
6. Vertical hydraulic conductivity in layer 2 (K_{v2}),
7. Hydraulic flow barrier conductance (K_{hfb}),
8. Recharge in the Rustler Aquifer outcrop (Recharge),
9. Lateral inflow from the Glass and Davis mountains (Lateral),
10. General-head boundary conductance (K_{ghb}),
11. Streambed conductance (K_{strm}),
12. Spring conductance (K_{sprg}),
13. General-head boundary elevation (Z_{ghb}),
14. Stream elevation (Z_{strm}), and
15. Spring elevation (Z_{sprg}).

Equation 8.3.1 was used for sensitivities 8 and 9, Equation 8.3.2 was used for sensitivities 1-7 and 10-12, and Equation 8.3.3 was used for sensitivities 13-15.

Figure 8.3.1 shows the sensitivity of head in the Rustler Aquifer to changes in horizontal and vertical hydraulic conductivity and in hydraulic flow barrier conductance. The most sensitive individual parameter is the horizontal hydraulic conductivity of layer 2. Figure 8.3.2 depicts the sensitivity of head in the Rustler Aquifer to changes in recharge and boundary condition conductances. The most sensitive boundary condition parameter is the recharge rate in the Rustler Aquifer outcrop. Figure 8.3.3 shows the sensitivity of head in the Rustler Aquifer to changes in boundary condition elevations. The most sensitive boundary condition elevation is that of the general-head boundaries representing the Edwards-Trinity (Plateau) and Pecos Valley aquifers.

Figure 8.3.4 shows the sensitivity of stream gain/loss to changes in horizontal and vertical hydraulic conductivity and in hydraulic flow barrier conductance. By far the most sensitive individual parameter is the horizontal hydraulic conductivity of layer 2. Figure 8.3.5 depicts the sensitivity of stream gain/loss to changes in recharge and boundary condition conductances. The most sensitive boundary condition parameter is the recharge rate in the Rustler Aquifer outcrop. Figure 8.3.6 shows the sensitivity of stream gain/loss to changes in boundary condition elevations. The most sensitive parameter is the elevation of the stream itself.

Figure 8.3.7 shows the sensitivity of spring flow to changes in horizontal and vertical hydraulic conductivity and in hydraulic flow barrier conductance. By far the most sensitive individual parameter is the horizontal hydraulic conductivity of layer 2. Figure 8.3.8 depicts the sensitivity of spring flow to changes in recharge and boundary condition conductances. The most sensitive boundary condition parameters are the recharge rate in the Rustler Aquifer outcrop and the conductance of the general-head boundaries. The spring flows are also sensitive to lateral inflow from the Glass and Davis mountains and to spring conductance. Figure 8.3.9 shows the sensitivity of spring flow to changes in boundary condition elevations. The most sensitive parameters are the elevation of the springs themselves and the elevation of the general-head boundary.

The hydrostructural subdomains of the Rustler Aquifer are largely hydraulically isolated from one another. The sensitivity of simulated heads in a given subdomain to model-wide changes in parameters is, therefore, instructive since it is indicative of the sensitivity of heads to changes in parameters within that subdomain. Plots of the sensitivity of mean heads within individual subdomains are included in Appendix A with Figures A.1 through A.3 pertaining to the steady-state model.

Final Groundwater Availability Model for the Rustler Aquifer

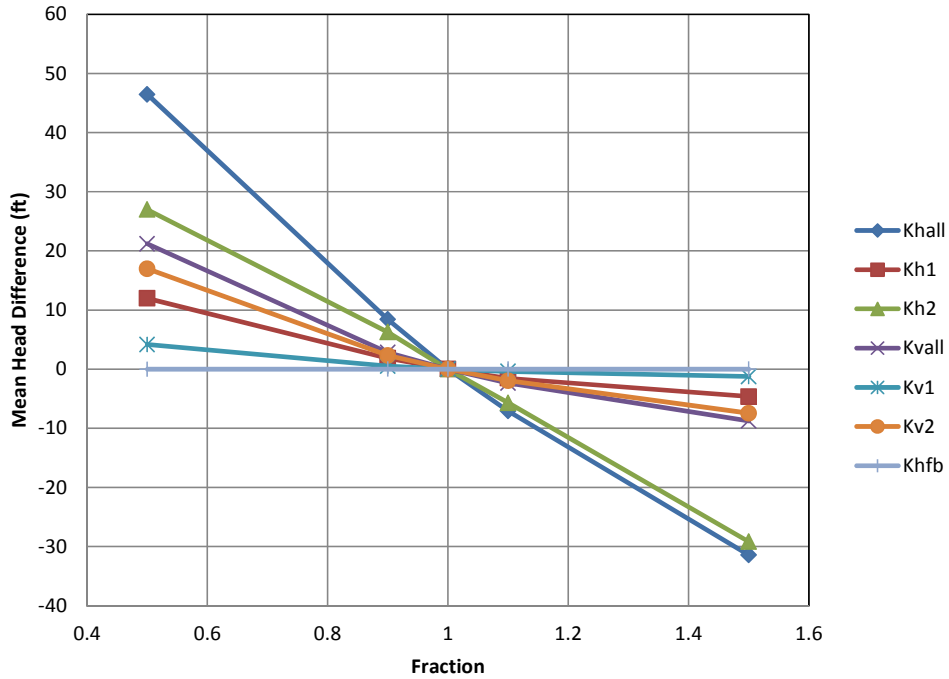

Figure 8.3.1 Steady-state head sensitivity in feet of the Rustler Aquifer to changes in hydraulic conductivities.

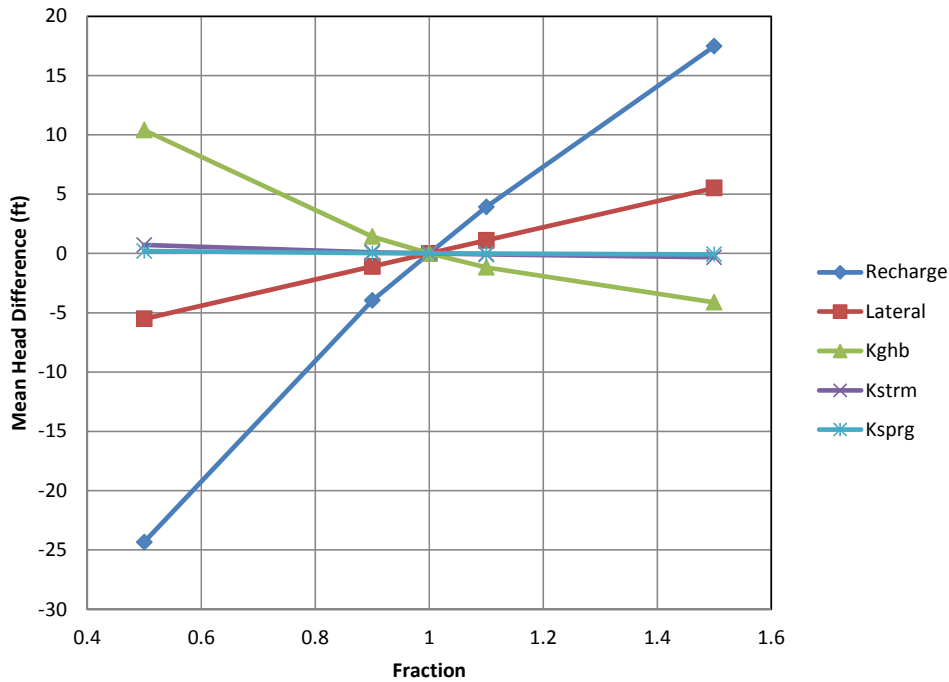

Figure 8.3.2 Steady-state head sensitivity in feet of the Rustler Aquifer to changes in boundary condition flows and conductances.

Final Groundwater Availability Model for the Rustler Aquifer

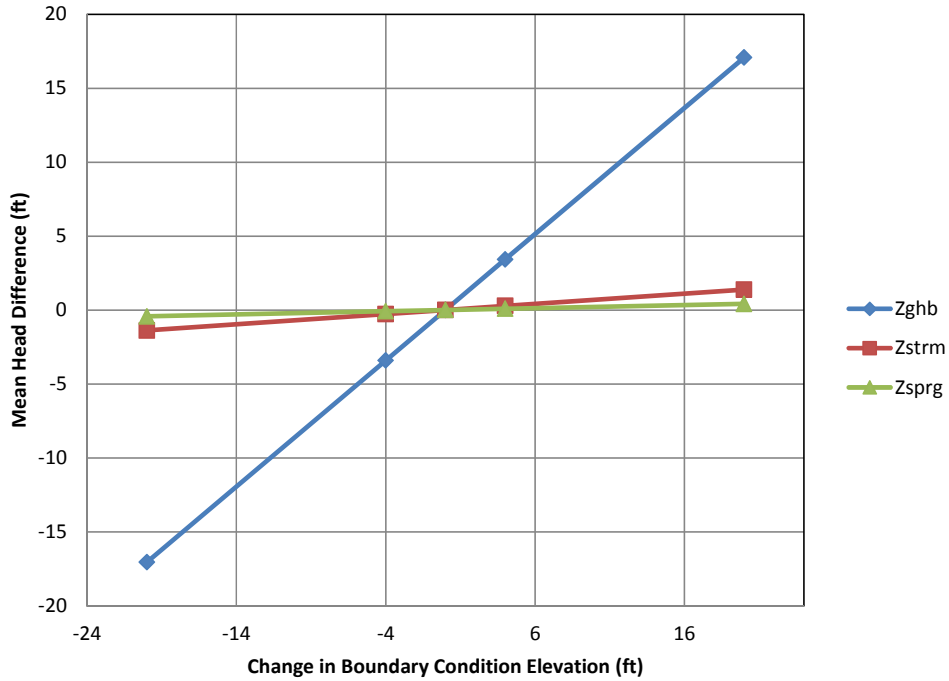

Figure 8.3.3 Steady-state head sensitivity in feet of the Rustler Aquifer to changes in boundary condition elevations.

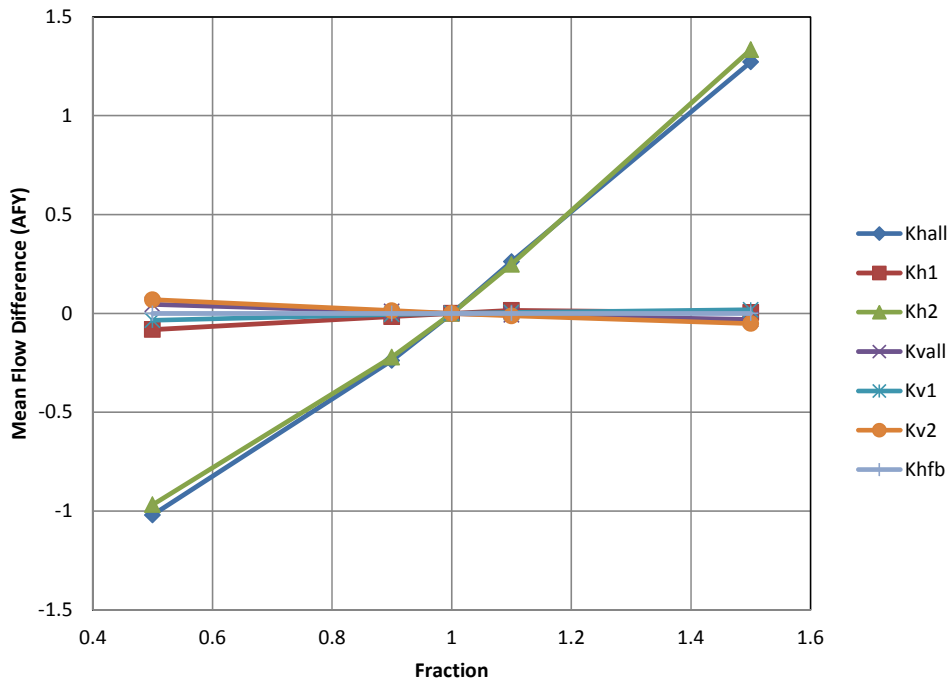

Figure 8.3.4 Steady-state stream gain/loss sensitivity in acre-feet per year to changes in hydraulic conductivities.

Final Groundwater Availability Model for the Rustler Aquifer

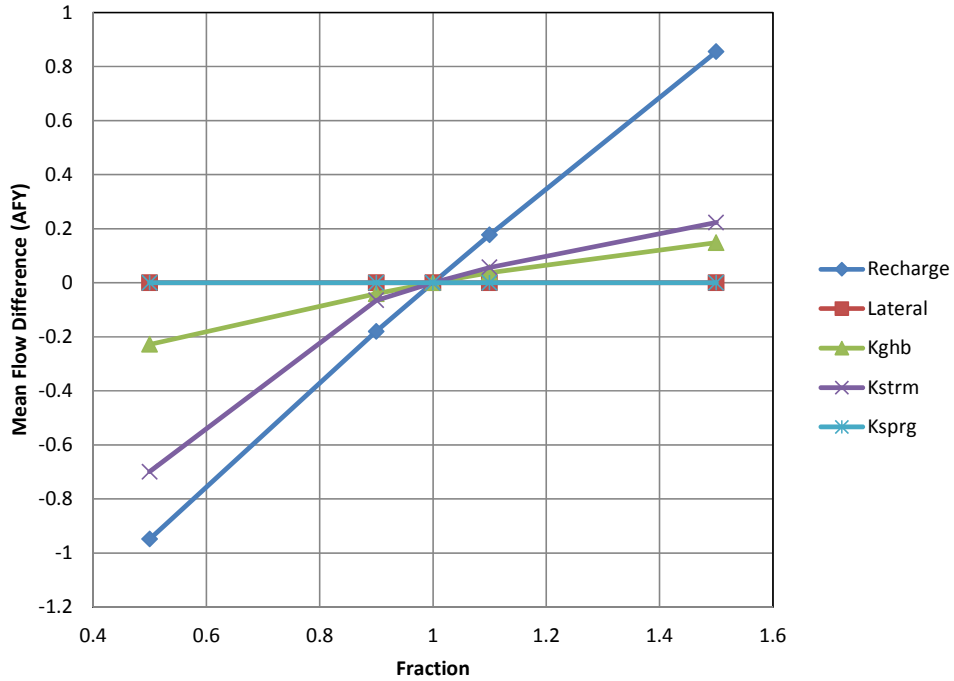

Figure 8.3.5 Steady-state stream gain/loss sensitivity in acre-feet per year to changes in boundary condition flows and conductances.

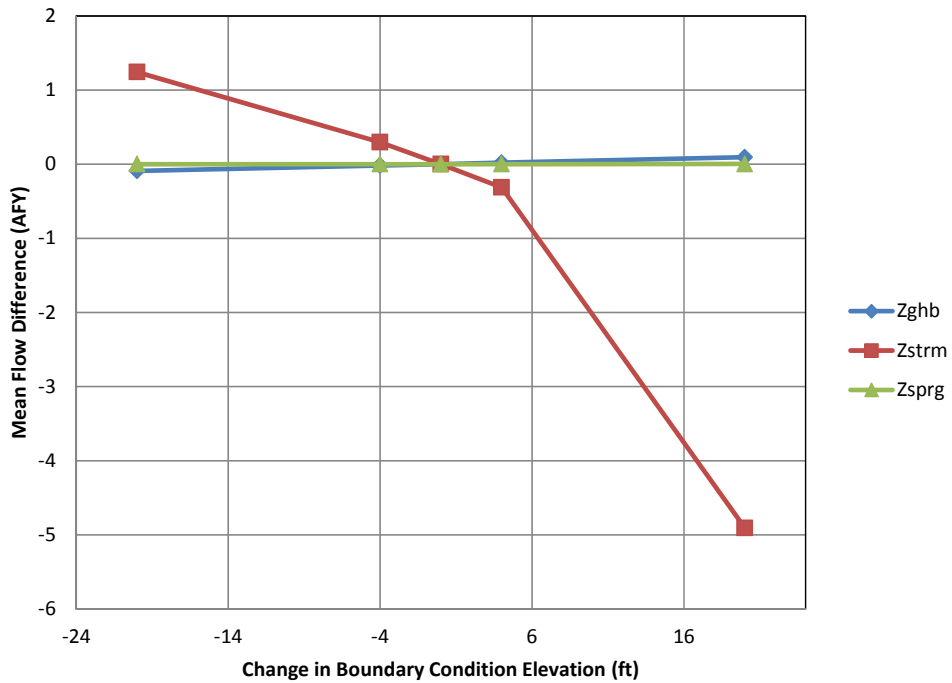

Figure 8.3.6 Steady-state stream gain/loss sensitivity in acre-feet per year to changes in boundary condition elevations.

Final Groundwater Availability Model for the Rustler Aquifer

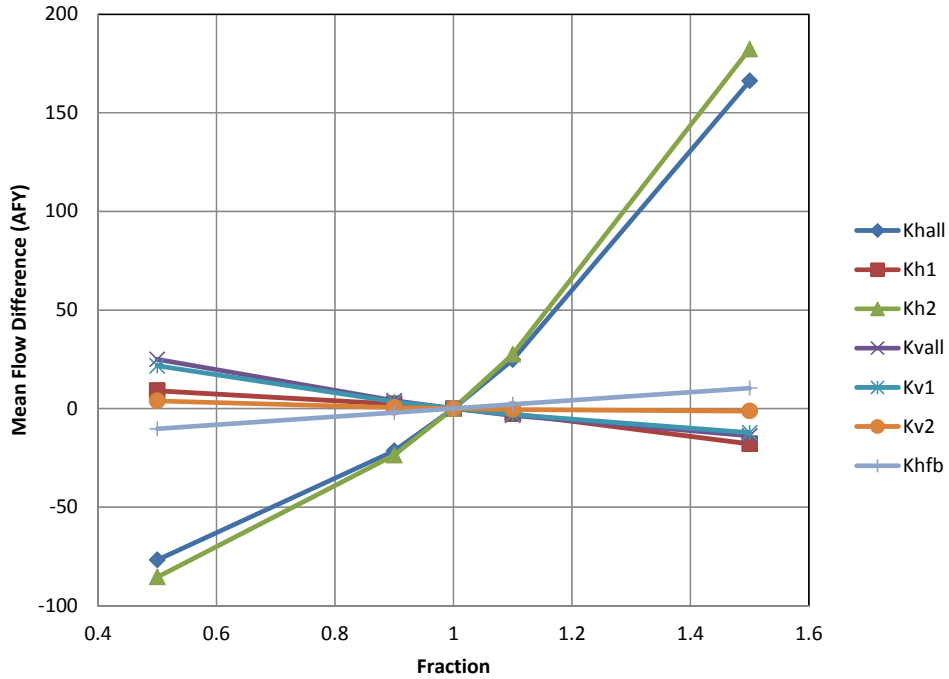

Figure 8.3.7 Steady-state spring flow sensitivity in acre-feet per year to changes in hydraulic conductivities.

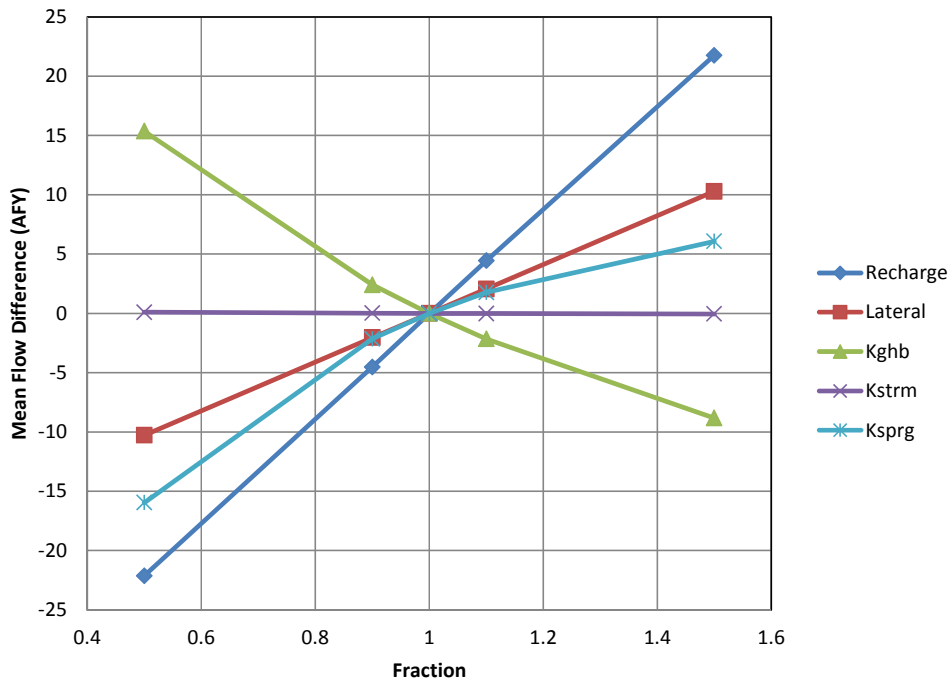

Figure 8.3.8 Steady-state spring flow sensitivity in acre-feet per year to changes in boundary condition flows and conductances.

Final Groundwater Availability Model for the Rustler Aquifer

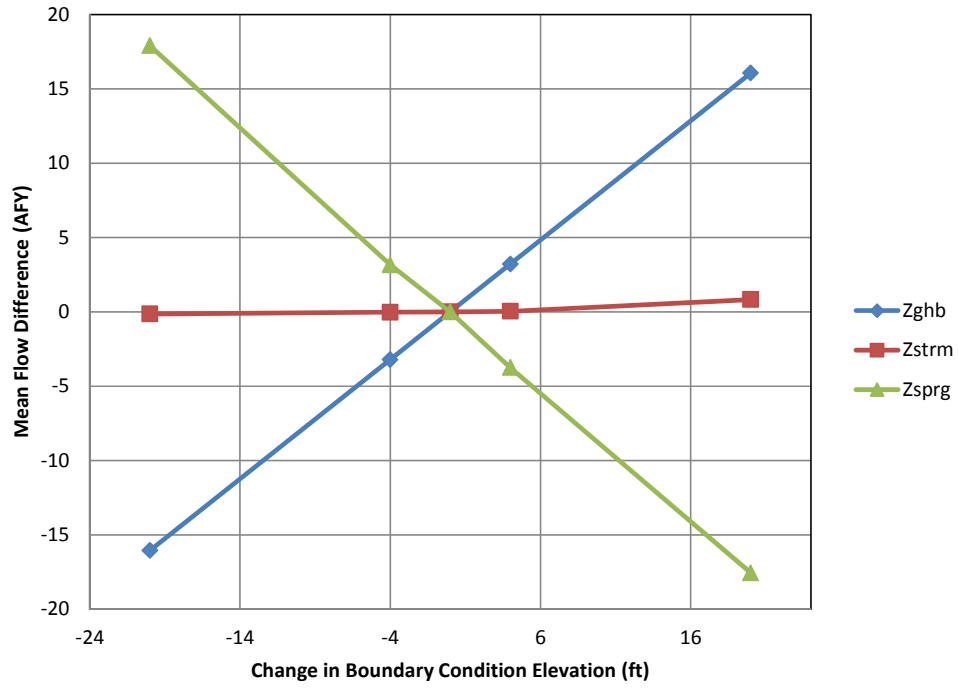

Figure 8.3.9 Steady-state spring flow sensitivity in acre-feet per year to changes in boundary condition elevations.

9.0 Transient Model

This section describes calibration of the transient model, presents the transient model results, and describes the sensitivity analysis for the transient model. The transient model included the steady-state model within the first stress period and a transient calibration period from 1919 through 2008. The time periods corresponding to the transient model stress periods are summarized in Equation 9.0.1.

$$\text{year} = \text{stress period} + 1917 \quad (9.0.1)$$

Section 9.1 describes the model calibration. Section 9.2 presents model results for the calibration time period. Section 9.3 presents the sensitivity analysis results.

9.1 Calibration

All properties or parameters common with the steady-state model are identical in the transient model. Section 8.1 contains the discussion of hydraulic properties in the steady-state and transient models. The calibrated hydraulic properties for the combined model are summarized in Table 9.1.1. Transient water-level measurements provide information about temporal trends in the aquifer and were compared with the simulated trends. A discussion of important inputs and new properties (such as storage estimates) follows.

9.1.1 Calibration Targets

Water-level measurements are needed as targets for the transient model calibration. Selection of water-level measurements over the transient calibration period was discussed in Section 4.3.2. Water-level targets were screened to omit wells being pumped, however, further screening was conducted to ensure that the measurements were applicable as targets in the transient model calibration. Flowing wells were removed from the head target dataset unless the well had ceased to be artesian and water-level measurements below land surface were available.

Transient targets included 231 water-level measurements from 50 locations in the Rustler Aquifer. A statistically insignificant number of grid blocks within the Rustler Aquifer contained coincident wells so that no grid block level comparison of water levels was feasible.

9.1.2 Storage Parameters

Storativity and specific yield are properties required in a transient model that are not needed in a steady-state model. The development of the storage properties for the model is discussed in Section 6.4.3. The majority of the Rustler Aquifer is confined with 6.8 percent of the aquifer outcropping (i.e., at land surface). During calibration, the specific storage in subdomains 4B and 7B were increased from 1×10^{-6} to 1×10^{-5} per foot. This value is still within the estimated range of specific storages for the Rustler Aquifer of 6.11×10^{-7} to 2.33×10^{-5} per foot presented in Table 4.6.3. All other storage parameters remained unaltered from initial estimates during calibration. The calibrated storativity distribution for the Rustler aquifer is shown in Figure 9.1.1. Note that the Rustler Aquifer outcrop was assigned a uniform specific yield value of 0.15.

9.1.3 Pumping

One of the challenges of extending the calibration period to include all of the water-level measurements was the task of estimating historical pumping for the period prior to 1980. These estimates are more uncertain than the pumping estimates from 1980 through the end of the calibration period and this fact impacts the calibration of the model. As is clear from the two hydrographs in Pecos County shown in Figure 4.3.19, significant water-level declines occurred within subdomain 4B prior to 1980. An investigation to determine whether this drawdown could be attributed to contemporaneous water-level declines in the overlying Edwards-Trinity (Plateau) and Pecos Valley aquifers concluded that this was not the case. The declines in the Edwards-Trinity (Plateau) Aquifer are smaller than those observed in the Rustler Aquifer in Pecos County, which would imply the Rustler Aquifer heads are responding to something other than, or in addition to, hydraulics in the overlying Edwards-Trinity (Plateau) and Pecos Valley aquifers. Varying the vertical conductivity of the Dewey Lake and Dockum formations in layer 1 through a range of reasonable values indicated that the Edwards-Trinity (Plateau) and Pecos Valley aquifers have very little impact on water levels in the Rustler Aquifer in this area of the model. It was, therefore, concluded that the observed drawdown in the Rustler Aquifer in Pecos County is due to development in the Rustler Aquifer. Inspection of the observed hydrographs in wells 5216608 and 5216609 from Figure 4.3.19 shows a steep decline from approximately 1962 to 1970 followed by a recovery beginning prior to 1980 and continuing to the last measurement.

Final Groundwater Availability Model for the Rustler Aquifer

While a flowing well could potentially cause the observed water-level decline, it could not account for the subsequent period of recovery. Therefore, pumping must be the cause of the observed water-level behavior.

Inspection of Figure 6.3.8 showed very little pumping in subdomain 4B where these wells are located. Indeed, initial simulations showed virtually no simulated drawdown at wells 5216608 and 5216609. Based on discussions with TWDB staff, it was decided that the pumping dataset was uncertain and other available sources of information should be used to adjust pumping when the pumping dataset was inconsistent with observed aquifer behavior. The most helpful additional source of pumping information was the study of the Edwards-Trinity (Plateau) Aquifer in the Leon-Belding area by Thornhill Group, Inc. (2008). Review of that report indicates that permitted pumping from the Rustler Aquifer in the Belding area, which is where these wells are located, is 5,970 acre-feet per year. By introducing additional pumping at the seven Rustler Aquifer wells in the Belding area, the simulated drawdown at wells 5216608 and 5216609 is better matched to the observed drawdown. The final calibrated pumping reaches a maximum of 4,226 acre-feet per year in the Belding area wells, 71 percent of the permitted amount. The final, adjusted pumping for the model is shown in Figure 9.1.2.

Table 9.1.1 Calibrated hydraulic properties in the Rustler Aquifer GAM.

Parameter	Units	Layer	Minimum	Maximum	Median	Arithmetic Mean	Geometric Mean
Horizontal Hydraulic Conductivity	feet/day	1	uniform 0.1 ^a or 10 ^b				
		2	0.01	5.0	0.201	0.813	0.156
Vertical Hydraulic Conductivity	feet/day	1	uniform 0.0001 ^a or 0.01 ^b				
		2	1.2 x 10 ⁻⁷	0.0705	0.00015	0.000866	0.000128
Storativity	--	1	0.0001	0.00254	0.000523	0.00052	0.00043
		2	0.0001	0.00979	0.000375	0.00109	0.000541
Specific Yield	--	1	not applicable				
		2	uniform 0.15				

^a Dewey Lake and Dockum formations present

^b Layer 1 in the absence of Dewey Lake and Dockum formations

Final Groundwater Availability Model for the Rustler Aquifer

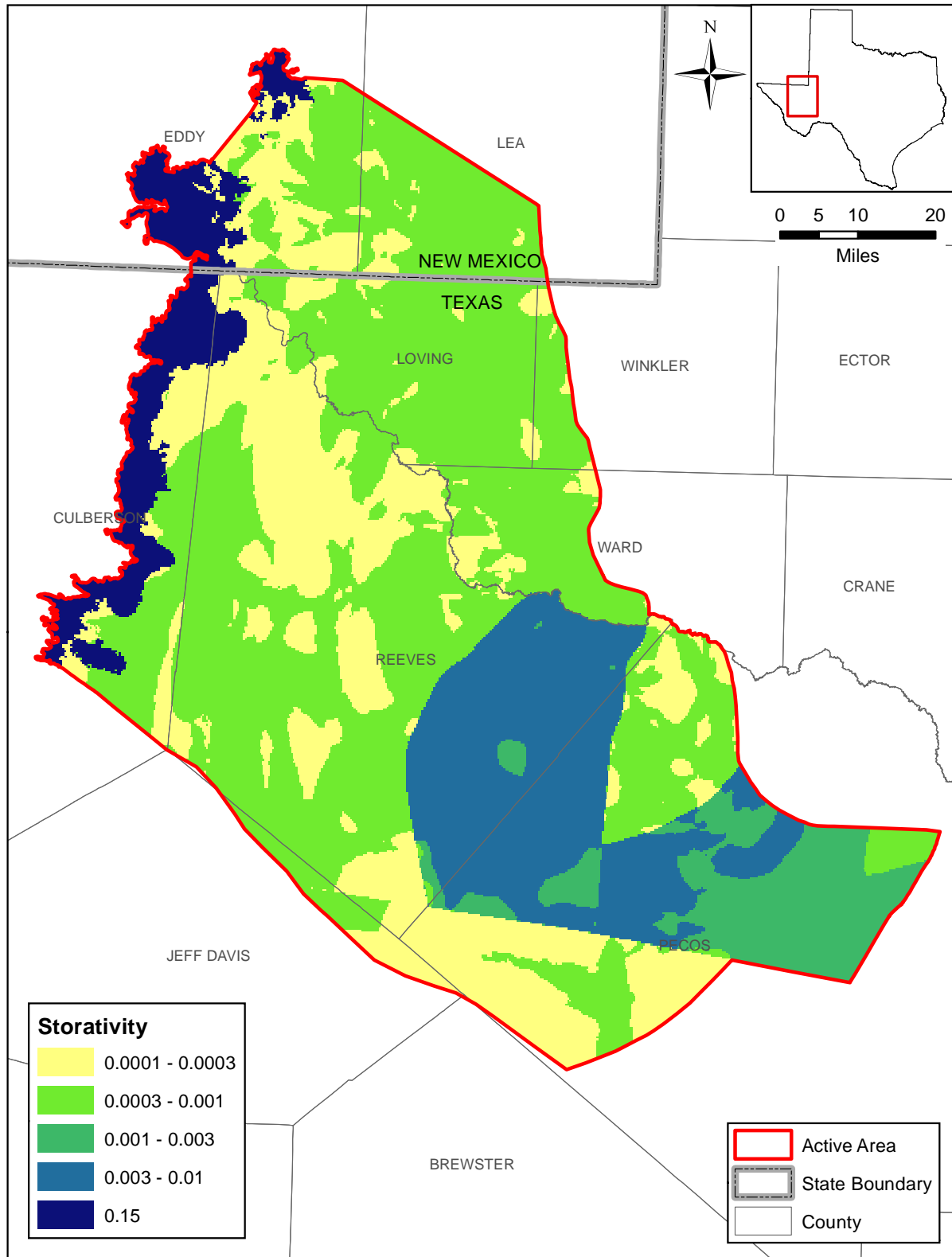

Figure 9.1.1 Calibrated storativity for the Rustler Aquifer. Note that the value of 0.15 represents specific yield in the outcrop.

Adjusted Pumping by Domain

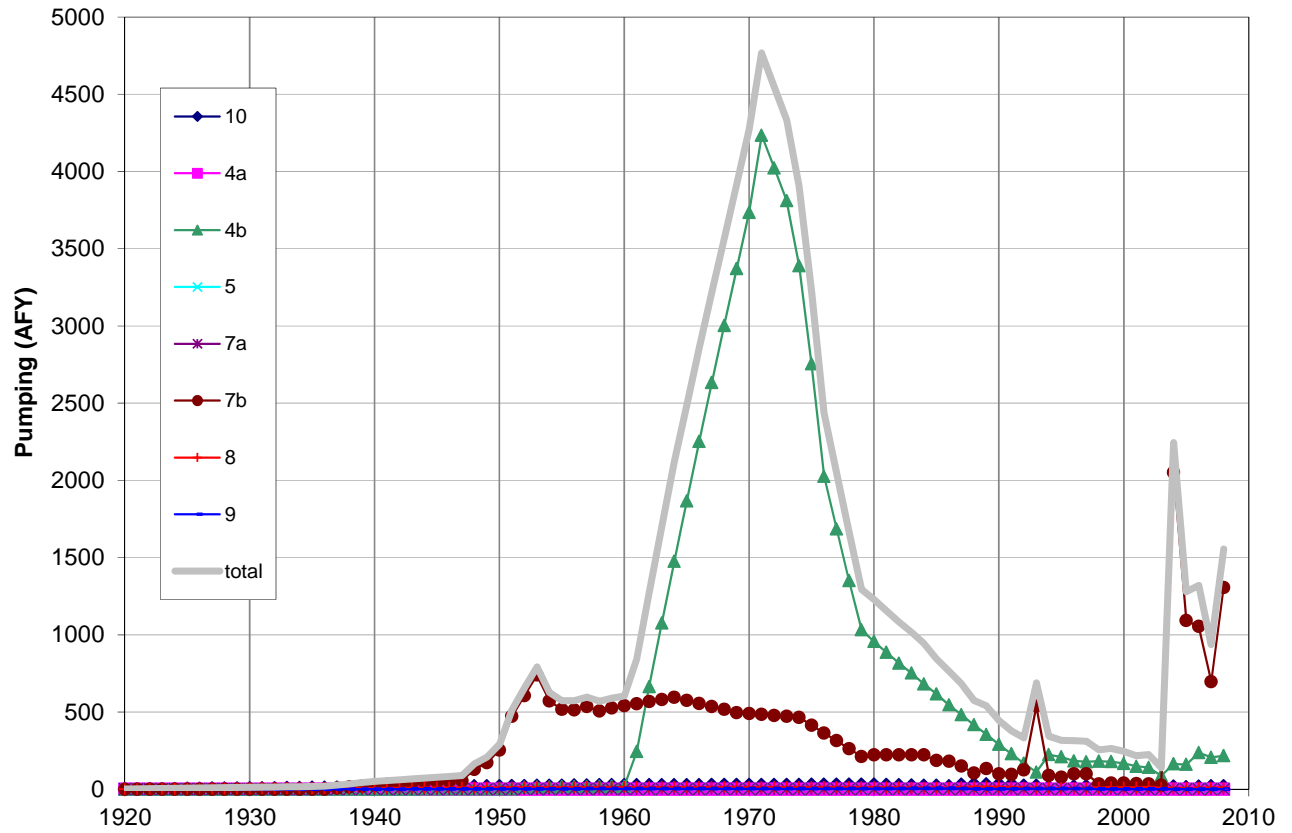

Figure 9.1.2 Adjusted pumping for the entire Rustler Aquifer and by hydrostructural subdomain.

This page intentionally left blank.

9.2 Simulation Results

Results for the transient model are presented in this section. Simulated water-level elevations are compared to measured values, and stream and spring leakages and water budgets are discussed.

9.2.1 Water-Level Elevations

In an attempt to use all of the historical water-level measurements, the transient model calibration period was considered to be the entire transient model period from 1919 through 2008. Because the earliest available water-level target is in the year 1939, this results in an effective transient calibration period from 1939 through 2008. Table 9.2.1 provides the summary statistics for the transient model calibration of the Rustler Aquifer. The adjusted mean absolute error for the Rustler Aquifer is 2 percent for the transient calibration period. The adjusted mean absolute error is well below the groundwater availability model criteria of 10 percent. To assess the agreement between the simulated and observed water levels at individual times within the transient calibration period, the adjusted mean absolute error was calculated for each year in which one or more water-level measurements were available (Figure 9.2.1). Apart from the years 1940 and 1946, for which there was only a single water-level measurement each, the adjusted mean absolute error was less than 5 percent for all years. It should be noted that, due to the lack of water-level measurements in any given year, the maximum number of measurements in a single year is 24 occurring in 1959, these sample sizes are not statistically significant. However, Figure 9.2.1 does indicate that there is relatively little temporal bias in the calibration.

Comparisons of simulated versus observed water levels and residuals versus observed water levels at the target wells for the transient model calibration period from 1939 through 2008 are shown in Figure 9.2.2. Residuals in the Rustler Aquifer fall between -194 and 294 feet with 93 percent falling between -100 and 100 feet. The residuals for the Rustler Aquifer are relatively evenly split with 46 percent overpredicting and 54 percent underpredicting. The mean error for the Rustler Aquifer is 10 feet indicating that the model exhibits little bias.

Posted average residuals between observed and simulated water levels for the calibration period from 1939 through 2008 are provided in Figure 9.2.3. A positive residual indicates that the model overpredicts the water-level elevation, while a negative residual indicates underprediction. There are only three years during which there are more than 10 water-level measurement

locations, 1959 (19 wells), 1970 (15 wells), and 1988 (11 wells). Figures 9.2.4, 9.2.5, and 9.2.6 show the simulated water-level elevations and residuals in 1959, 1970, and 1988, respectively. The simulated water levels and residuals at the end of transient model calibration in 2008 are shown in Figure 9.2.7. Over the calibration period and for the individual years of 1959, 1970, 1988 and 2008, the model shows no significant indication of spatial bias in the residuals.

Six wells within the Rustler Aquifer have five or more water-level measurements over time that provide useful information for transient history matching. In the following discussion, hydrographs of simulated and observed water-level elevations are presented in an attempt to describe temporal trends in the Rustler Aquifer. All six hydrographs for the transient model are presented in Figure 9.2.8. The hydrographs for wells 4754201 and 4754302 located in the Rustler Aquifer outcrop in Culberson County vary 14 and 29 feet, respectively, but exhibit no clear trend with time. These wells are in close proximity to each other but have a difference of 156 feet in their mean head. The simulated heads for these two wells underpredict the measured heads by 41 feet in the well with the higher heads (well 4754201) and overpredict the measured heads by 62 feet in the well with the lower heads (well 4754302). The mean difference between the simulated and observed heads at these two wells is 52 feet, which essentially splits the mean difference in the observed heads at these two wells of 156 feet.

The hydrographs for the two closely spaced wells located in Reeves County (wells 4660902 and 5204302) show conflicting trends of rising and falling heads between the mid- 1950s and 1970. After 1970, well 4660902 exhibits relatively stable observed water levels and no water-level measurements are available for well 5204302. The simulated hydrographs at these wells show a general decline in head over time with the mean simulated heads consistent with the observed water levels.

The observed water levels in wells 5216608 and 5216609 located in Pecos County exhibit a very similar trend with a steep decline in heads from the early 1960s through the early 1970s followed by a period of recovery from the middle 1970s through the late 2000s. The simulated hydrographs, after the adjustments to pumping in the Belding area wells discussed in Section 9.1.3, match the observed water levels very well in both the decline and recovery portions of the hydrographs. Not coincidentally, the Belding area wells are the ones for which we have the best point pumping information.

9.2.2 Streams, Springs, and Evapotranspiration

The distribution of simulated stream gain/loss at the end of the transient calibration period (2008) is shown in Figure 9.2.9. Stream gain/loss estimates are available for a segment of the Pecos River in the Rustler Aquifer outcrop in New Mexico (see Section 4.5.1). The estimate for 2008 indicates a gain of 8,905 acre-feet per year. Simulated flows were consistently gaining during the transient time period in this portion of the Pecos River and equal 256 acre-feet per year in 2008. Simulated gains do not change appreciably with time because recharge was held constant in the Rustler Aquifer outcrop throughout the transient simulation period. Because the simulated gain is consistent with the average estimated gain for the portion of the Pecos River in contact with the Rustler Aquifer outcrop and is within one third of one standard deviation in the mean gain, no attempt was made to match stream gains and losses in individual years.

The simulated spring flows at each spring at the end of the calibration period (2008) are shown in Figure 9.2.10. Simulated spring flow is highest at 1,176 acre-feet per year during pre-development, begins to decrease in the 1940s as the Rustler Aquifer is developed, and is 536 acre-feet per year at the end of the calibration period (2008). Diamond Y Springs exhibits the largest individual spring flow with a maximum of 981 acre-feet per year during pre-development, which decreases to 342 acre-feet per year by 2008. A comparison of the simulated and observed spring discharges over time at Diamond Y Springs is shown in Figure 9.2.11. This plot shows consistency in magnitudes and temporal trends between the simulated and observed spring discharges. For the reasons discussed in Section 8.2.2, no attempt was made to calibrate the model to all of the individual measured spring flows. The simulated flow from flowing wells at the end of calibration is also depicted in Figure 9.2.10.

The simulated evapotranspiration at the end of the calibration period is shown in Figure 9.2.12. Evapotranspiration rates remain relatively constant over time with a maximum of 1,008 acre-feet per year during pre-development and a minimum of 1,003 acre-feet per year in 2008. This very small change in evapotranspiration is indicative of the constant recharge value applied and the lack of pumping reported in the vicinity of the outcrop.

9.2.3 Water Budget

Tables 9.2.2 and 9.2.3 show the water budget for the transient model totaled for the years 1950, 1960, 1970, 1980, 1990, 2000, and 2008 in acre-feet per year and percentage of total inflow,

respectively. The water budget for the transient model for 2008 is shown in Tables 9.2.4 and 9.2.5 by county and Groundwater Conservation District, respectively. The overall mass balance error for the transient simulation was 0.02 percent and the mass balance errors for individual stress periods never exceeded 0.08 percent, well under the groundwater availability model requirement of one percent. It is worthy of note that convergence of the model and an acceptable mass balance error would not have been possible without simulating the entire aquifer as a confined aquifer. The major avenues of inflow into the Rustler Aquifer are as direct recharge in the outcrops and indirect lateral flow from the Glass and Davis mountains and total 3,896 and 3,237 acre-feet per year, respectively. In these tables, cross-formational flow represents vertical flow between model layers (formations) and lateral flow represents flow within a model layer (formation). Any cross-formational flow that may occur between formations at faults is not accounted for in the numerical model nor in the water budgets summarized in Tables 9.2.4 and 9.2.5.

The transient model differs from the steady-state model in the amount of net inflow through storage due to development of the Rustler Aquifer and indirectly from development within the Edwards-Trinity (Plateau) and Pecos Valley aquifers as implemented through the general-head boundaries in layer 1. Table 9.2.2 shows a maximum release from storage into the Rustler Aquifer of 8,019 acre-feet per year in 1970. The actual simulated maximum release from storage into the aquifer of 8,395 acre-feet per year occurs in 1971 as illustrated in Figure 9.2.13, which summarizes the water balance in the Rustler Aquifer over time. The large releases from storage during this period compared to the recharge inflow into the aquifer indicate an unsustainable level of pumping during that period.

As in the steady-state model, the major mechanism of discharge from the Rustler Aquifer in the transient model is upward cross-formational flow. As development and associated water-level declines occur in the Edwards-Trinity (Plateau) and Pecos Valley aquifers, the cross-formational discharge from the Rustler Aquifer increases. Table 9.2.2 shows that both cross-formational discharge and pumping discharge are highest in 1970. Cross-formational flow peaks at 7,448 acre-feet per year in 1967 and pumping in the Rustler Aquifer peaks at 4,767 acre-feet per year in 1971 (see Figure 9.2.13). Discharge through flowing wells peaks at 2,907 acre-feet per year in 1949 and steadily decreases as water levels decrease over time. Similar to the flowing

Final Groundwater Availability Model for the Rustler Aquifer

wells, spring discharge steadily decreases with time. Evapotranspiration in the Rustler Aquifer outcrop is another major discharge mechanism and remains relatively constant through the transient period at approximately 1,003 to 1,004 acre-feet per year. Discharge to the Pecos River also remains constant with time. Table 9.2.2 indicates that the faults within the Rustler Aquifer adequately separate the flow systems within the aquifer such that development of the aquifer impacts discharge at flowing wells and springs in subdomains 4B and 7B but does not impact outflows in the outcrop.

The flow balance mechanisms with obvious rate changes over time are the effect of flowing wells and pumping in the Rustler Aquifer, which take water from storage over time, and the cross-formational flow from the Rustler Aquifer to the Edwards-Trinity (Plateau) and Pecos Valley aquifers, which increases to supply the pumping in the overlying aquifers.

Final Groundwater Availability Model for the Rustler Aquifer

Table 9.2.1 Calibration statistics for the entire transient calibration period (1939 through 2008).

Layer	Number of Targets	ME (feet)	MAE (feet)	RMS (feet)	Range (feet)	Adjusted MAE
Rustler	231	10.0	40.2	59.9	1794	0.022

ME = mean error

MAE = mean absolute error

RMS = root mean square

Final Groundwater Availability Model for the Rustler Aquifer

Table 9.2.2 Water budget for the transient model (all rates reported in acre-feet per year).

Year	Layer	Cross-Formational Flow	Recharge	Lateral Flow	Pumping	Flowing Wells	Springs	ET	GHBs	Streams	Storage
1950	1	5,659	0	0	0	0	0	0	-7,947	0	2,288
	2	-5,659	3,896	3,237	-291	-2,661	-951	-1,004	0	-256	3,684
	Total	0	3,896	3,237	-291	-2,661	-951	-1,004	-7,947	-256	5,973
1960	1	6,824	0	0	0	0	0	0	-10,064	0	3,241
	2	-6,824	3,896	3,237	-604	-2,088	-706	-1,004	0	-256	4,341
	Total	0	3,896	3,237	-604	-2,088	-706	-1,004	-10,064	-256	7,582
1970	1	7,369	0	0	0	0	0	0	-10,173	0	2,805
	2	-7,369	3,896	3,237	-4,273	-1,622	-634	-1,004	0	-256	8,019
	total	0	3,896	3,237	-4,273	-1,622	-634	-1,004	-10,173	-256	10,824
1980	1	7,121	0	0	0	0	0	0	-7,717	0	599
	2	-7,121	3,896	3,237	-1,228	-1,312	-558	-1,003	0	-256	4,342
	total	0	3,896	3,237	-1,228	-1,312	-558	-1,003	-7,717	-256	4,941
1990	1	6,445	0	0	0	0	0	0	-6,053	0	-393
	2	-6,445	3,896	3,237	-444	-1,281	-540	-1,003	0	-256	2,835
	total	0	3,896	3,237	-444	-1,281	-540	-1,003	-6,053	-256	2,442
2000	1	6,106	0	0	0	0	0	0	-6,641	0	536
	2	-6,106	3,896	3,237	-245	-1,246	-535	-1,003	0	-256	2,250
	total	0	3,896	3,237	-245	-1,246	-535	-1,003	-6,641	-256	2,785
2008	1	5,834	0	0	0	0	0	0	-6,168	0	333
	2	-5,834	3,896	3,237	-1,555	-1,254	-536	-1,003	0	-256	3,300
	total	0	3,896	3,237	-1,555	-1,254	-536	-1,003	-6,168	-256	3,633

ET = evapotranspiration

GHBs = general-head boundaries

Final Groundwater Availability Model for the Rustler Aquifer

Table 9.2.3 Water budget for the transient model expressed as a percentage of total inflow.

Year	Layer	Cross-Formational Flow	Recharge	Lateral Flow	Pumping	Flowing Wells	Springs	ET	GHBs	Streams	Storage
1950	1	43%	0%	0%	0%	0%	0%	0%	-61%	0%	17%
	2	-43%	30%	25%	-2%	-20%	-7%	-8%	0%	-2%	28%
	total	0%	30%	25%	-2%	-20%	-7%	-8%	-61%	-2%	46%
1960	1	46%	0%	0%	0%	0%	0%	0%	-68%	0%	22%
	2	-46%	26%	22%	-4%	-14%	-5%	-7%	0%	-2%	30%
	total	0%	26%	22%	-4%	-14%	-5%	-7%	-68%	-2%	52%
1970	1	41%	0%	0%	0%	0%	0%	0%	-57%	0%	16%
	2	-41%	22%	18%	-24%	-9%	-4%	-6%	0%	-1%	45%
	total	0%	22%	18%	-24%	-9%	-4%	-6%	-57%	-1%	60%
1980	1	59%	0%	0%	0%	0%	0%	0%	-64%	0%	5%
	2	-59%	32%	27%	-10%	-11%	-5%	-8%	0%	-2%	36%
	total	0%	32%	27%	-10%	-11%	-5%	-8%	-64%	-2%	41%
1990	1	67%	0%	0%	0%	0%	0%	0%	-63%	0%	-4%
	2	-67%	41%	34%	-5%	-13%	-6%	-10%	0%	-3%	30%
	total	0%	41%	34%	-5%	-13%	-6%	-10%	-63%	-3%	26%
2000	1	62%	0%	0%	0%	0%	0%	0%	-67%	0%	5%
	2	-62%	39%	33%	-2%	-13%	-5%	-10%	0%	-3%	23%
	total	0%	39%	33%	-2%	-13%	-5%	-10%	-67%	-3%	28%
2008	1	54%	0%	0%	0%	0%	0%	0%	-57%	0%	3%
	2	-54%	36%	30%	-14%	-12%	-5%	-9%	0%	-2%	31%
	total	0%	36%	30%	-14%	-12%	-5%	-9%	-57%	-2%	34%

ET = evapotranspiration

GHBs = general-head boundaries

Final Groundwater Availability Model for the Rustler Aquifer

Table 9.2.4 Water budget in the Rustler Aquifer by county for 2008 (all rates reported in acre-feet per year).

County	State	Cross-Formational Flow	Recharge	Lateral Flow	Pumping	Flowing Wells	Springs	ET	Streams	Storage
Andrews	TX	0	0	0	0	0	0	0	0	0
Brewster	TX	0	0	8	0	0	0	0	0	0
Crane	TX	0	0	0	0	0	0	0	0	0
Culberson	TX	-1,857	2,561	208	-32	0	-194	-87	0	148
Ector	TX	0	0	0	0	0	0	0	0	0
Eddy	NM	-118	1,188	0	0	0	0	-712	-256	0
Jeff Davis	TX	265	0	255	0	0	0	0	0	4
Lea	NM	42	0	0	0	0	0	0	0	4
Loving	TX	-239	0	0	0	0	0	0	0	23
Pecos	TX	-1,523	0	2,761	-220	-1,254	-342	0	0	586
Presidio	TX	0	0	0	0	0	0	0	0	0
Reeves	TX	-2,344	147	5	-1,304	0	0	-204	0	2,483
Ward	TX	-29	0	0	0	0	0	0	0	34
Winkler	TX	-31	0	0	0	0	0	0	0	17

ET = evapotranspiration

TX = Texas

NM = New Mexico

Table 9.2.5 Water budget in the Rustler Aquifer by Groundwater Conservation District for 2008 (all rates reported in acre-feet per year).

GCD	Cross-Formational Flow	Recharge	Lateral Flow	Pumping	Flowing Wells	Springs	ET	Streams	Storage
Jeff Davis County UWCD	265	0	255	0	0	0	0	0	4
Middle Pecos GCD	-1,523	0	2,761	-220	-1,254	-342	0	0	586
No GCD	-4,576	3,896	221	-1,336	0	-194	-1,003	-256	2,710

ET = evapotranspiration

GCD = Groundwater Conservation District

UWCD = Underground Water Conservation District

Final Groundwater Availability Model for the Rustler Aquifer

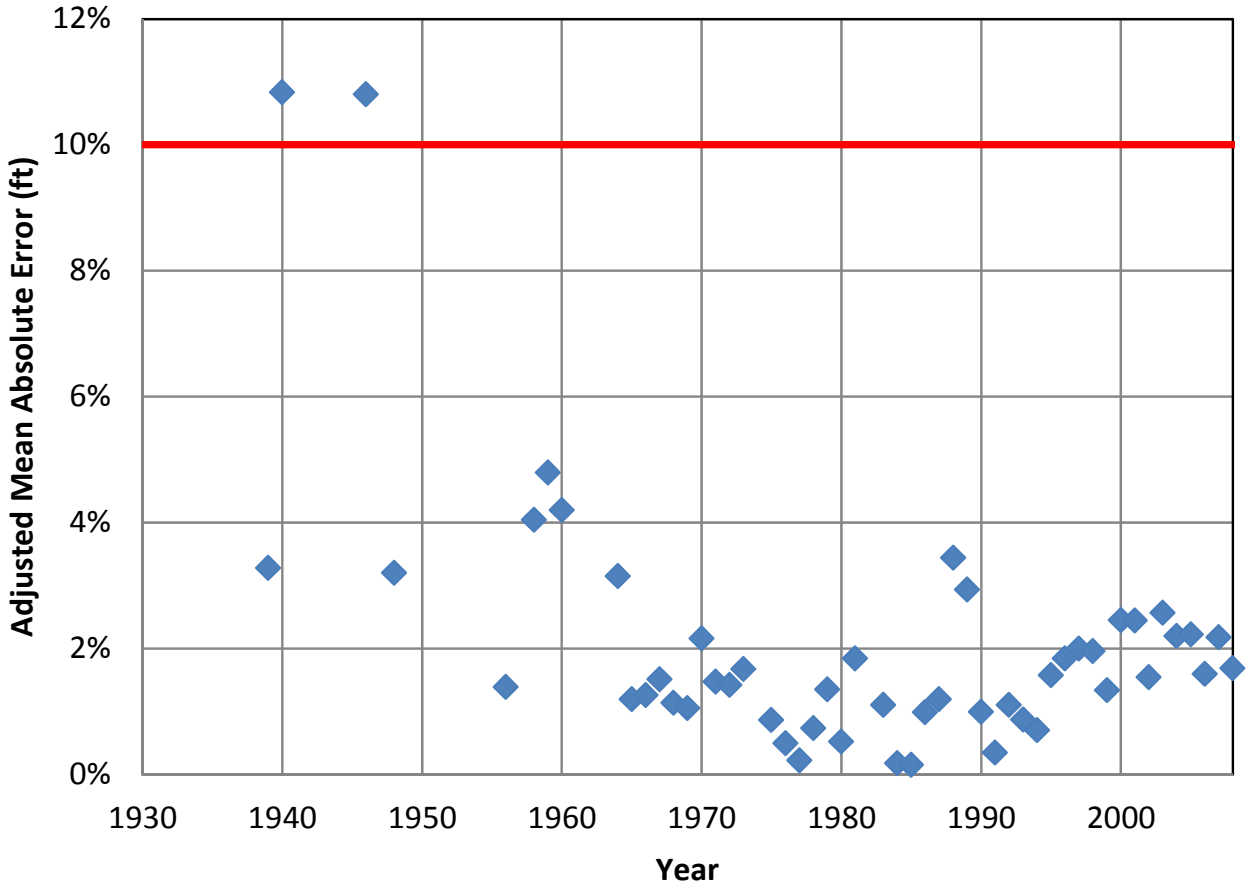

Figure 9.2.1 Adjusted mean absolute error in feet over time.

Final Groundwater Availability Model for the Rustler Aquifer

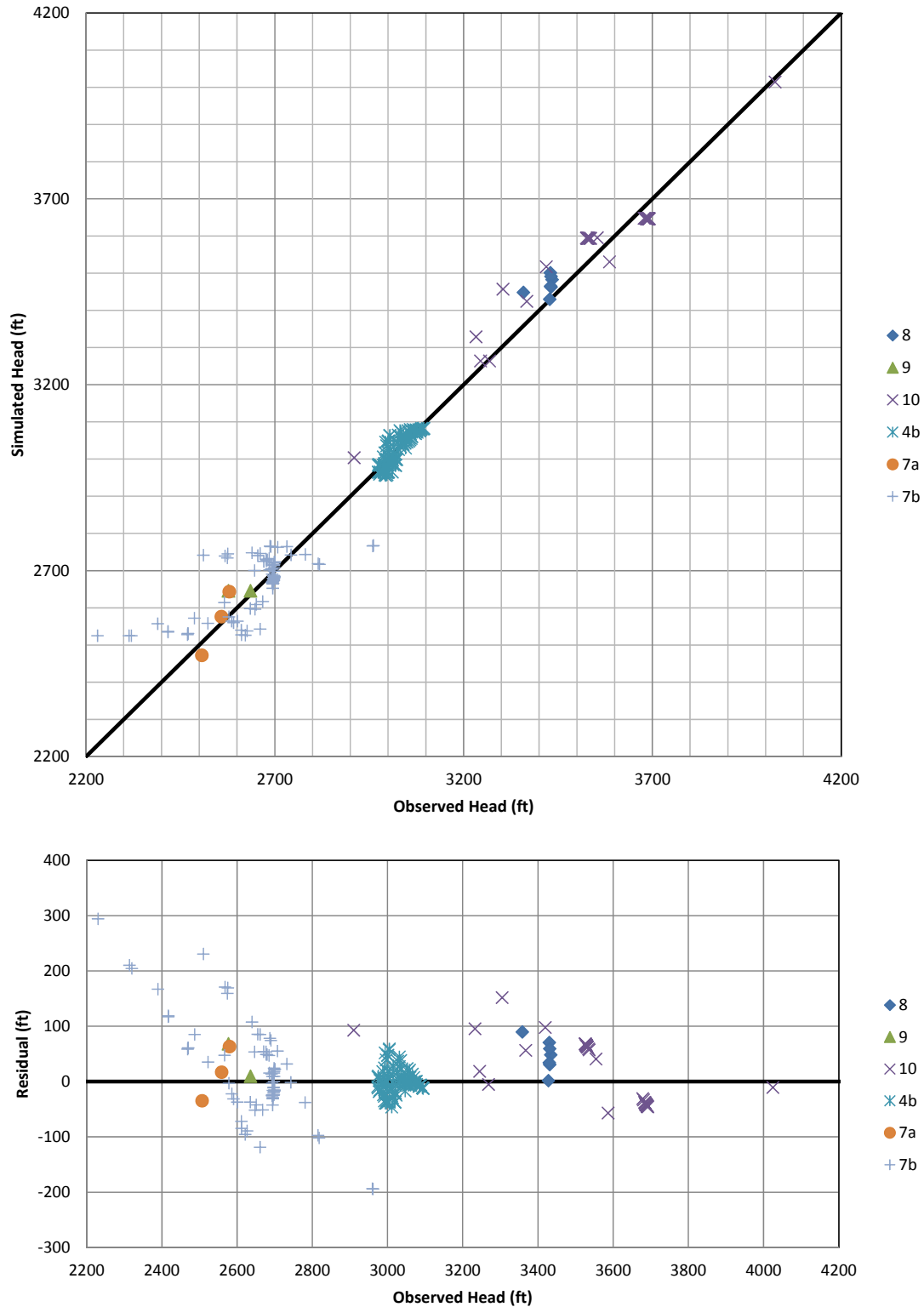

Figure 9.2.2 Plots of (a) simulated versus observed water-level elevations in feet and (b) residual versus observed water-level elevation in feet for the Rustler Aquifer by subdomain during the transient model calibration period (1939 through 2008).

Final Groundwater Availability Model for the Rustler Aquifer

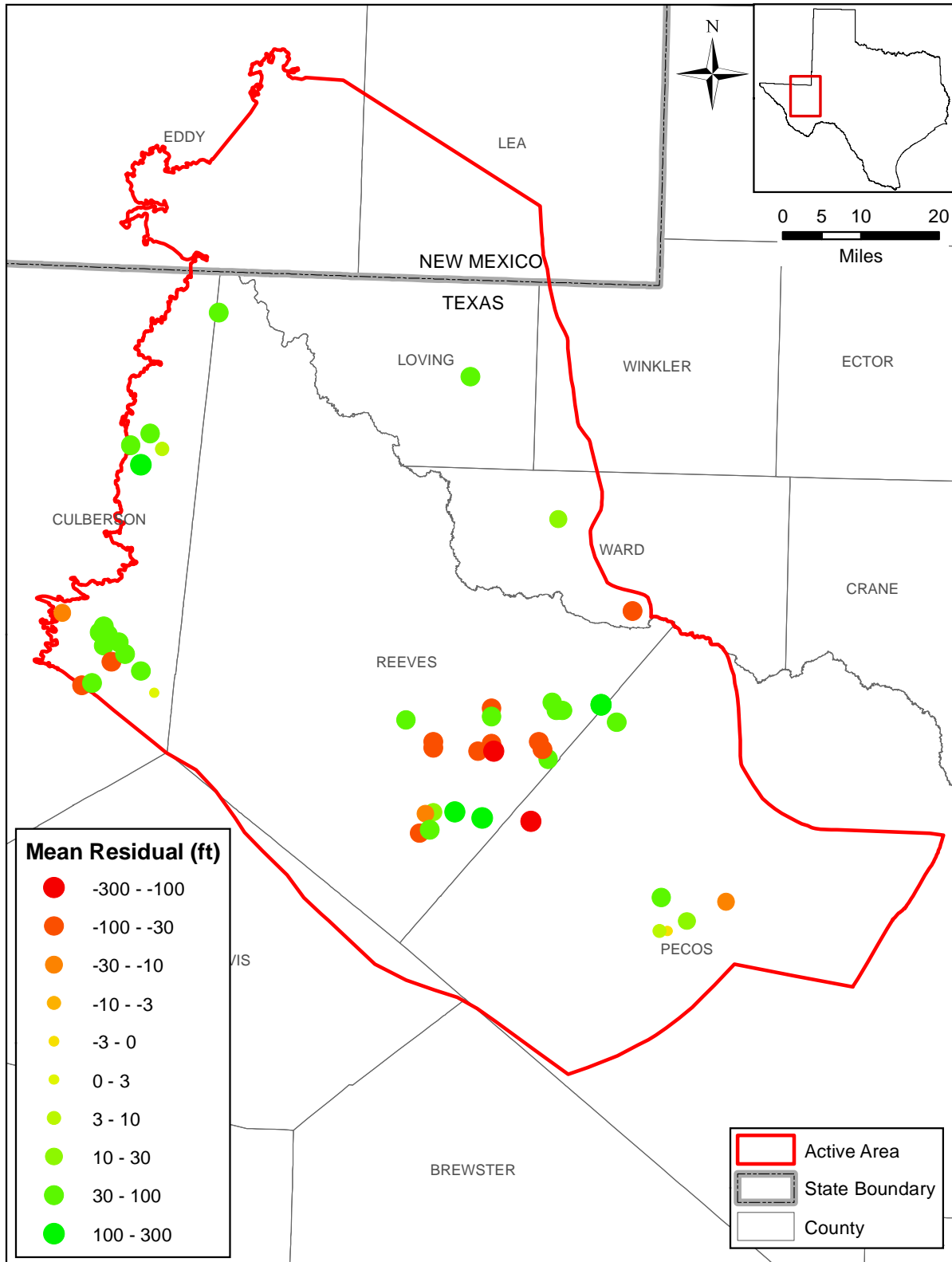

Figure 9.2.3 Average residuals in feet at target wells for the Rustler Aquifer during the entire transient model calibration (1939 through 2008).

Final Groundwater Availability Model for the Rustler Aquifer

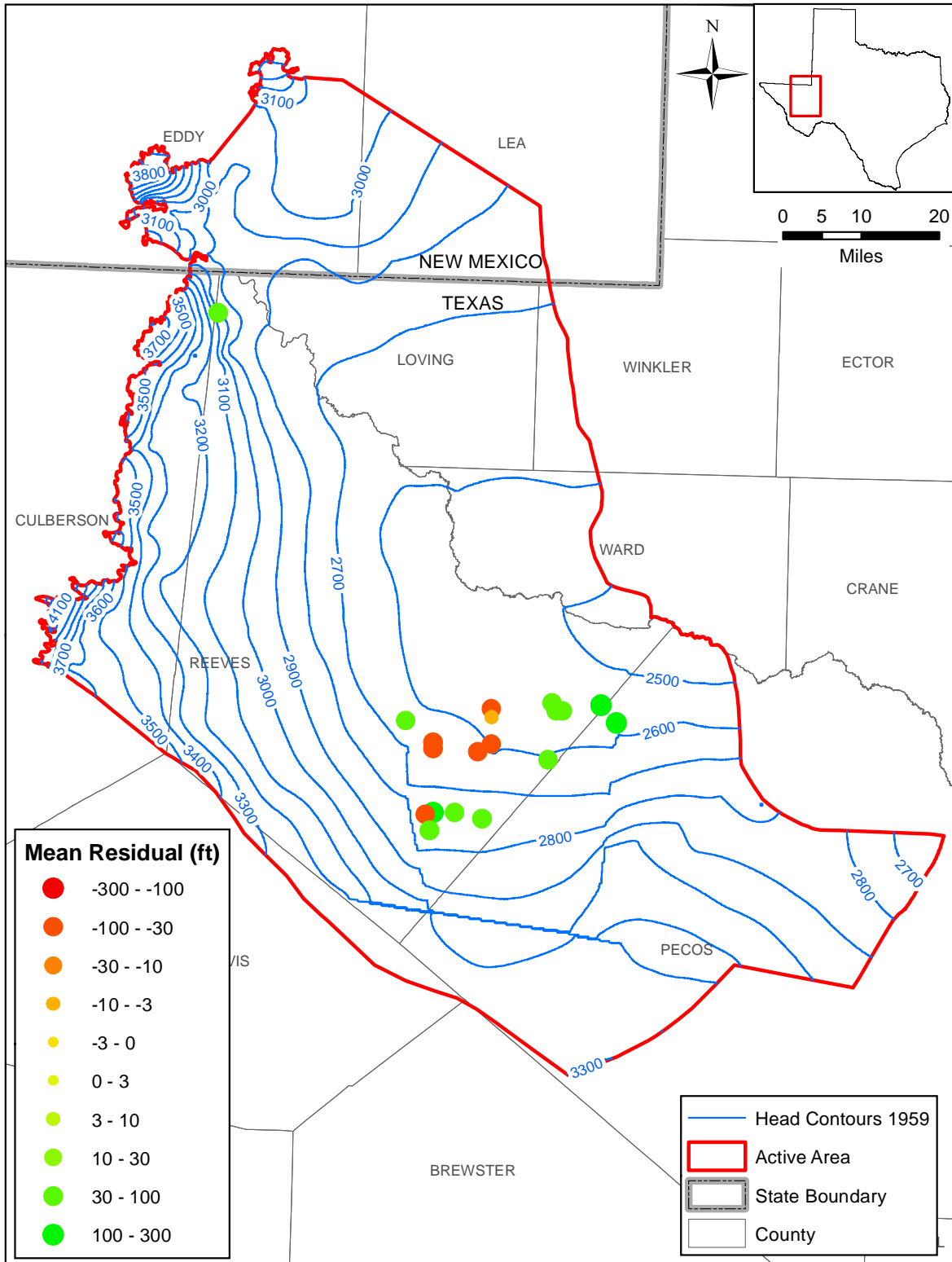

Figure 9.2.4 Simulated water levels and residuals in feet at target wells for the Rustler Aquifer in 1959.

Final Groundwater Availability Model for the Rustler Aquifer

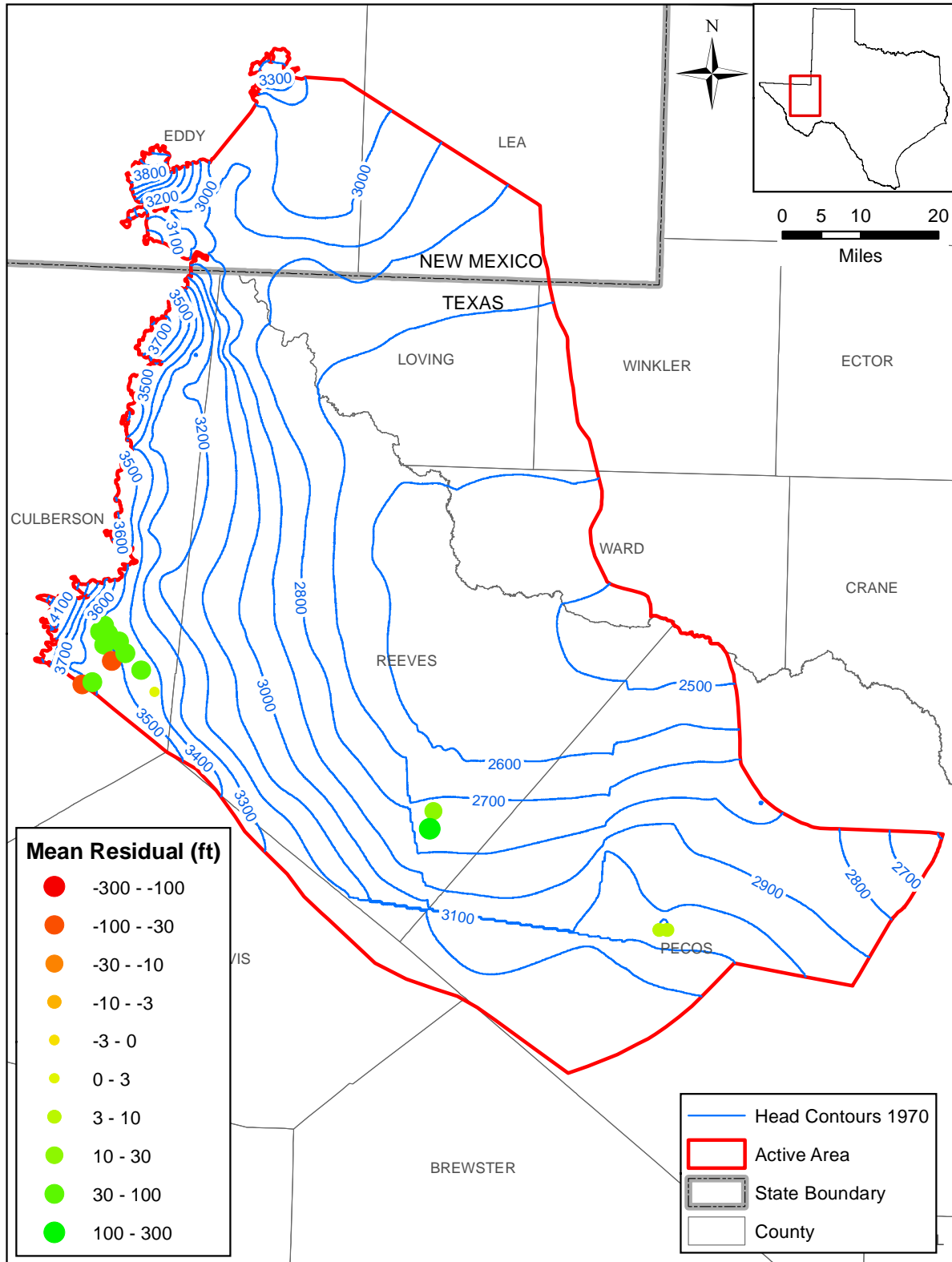

Figure 9.2.5 Simulated water levels and residuals in feet at target wells for the Rustler Aquifer for 1970.

Final Groundwater Availability Model for the Rustler Aquifer

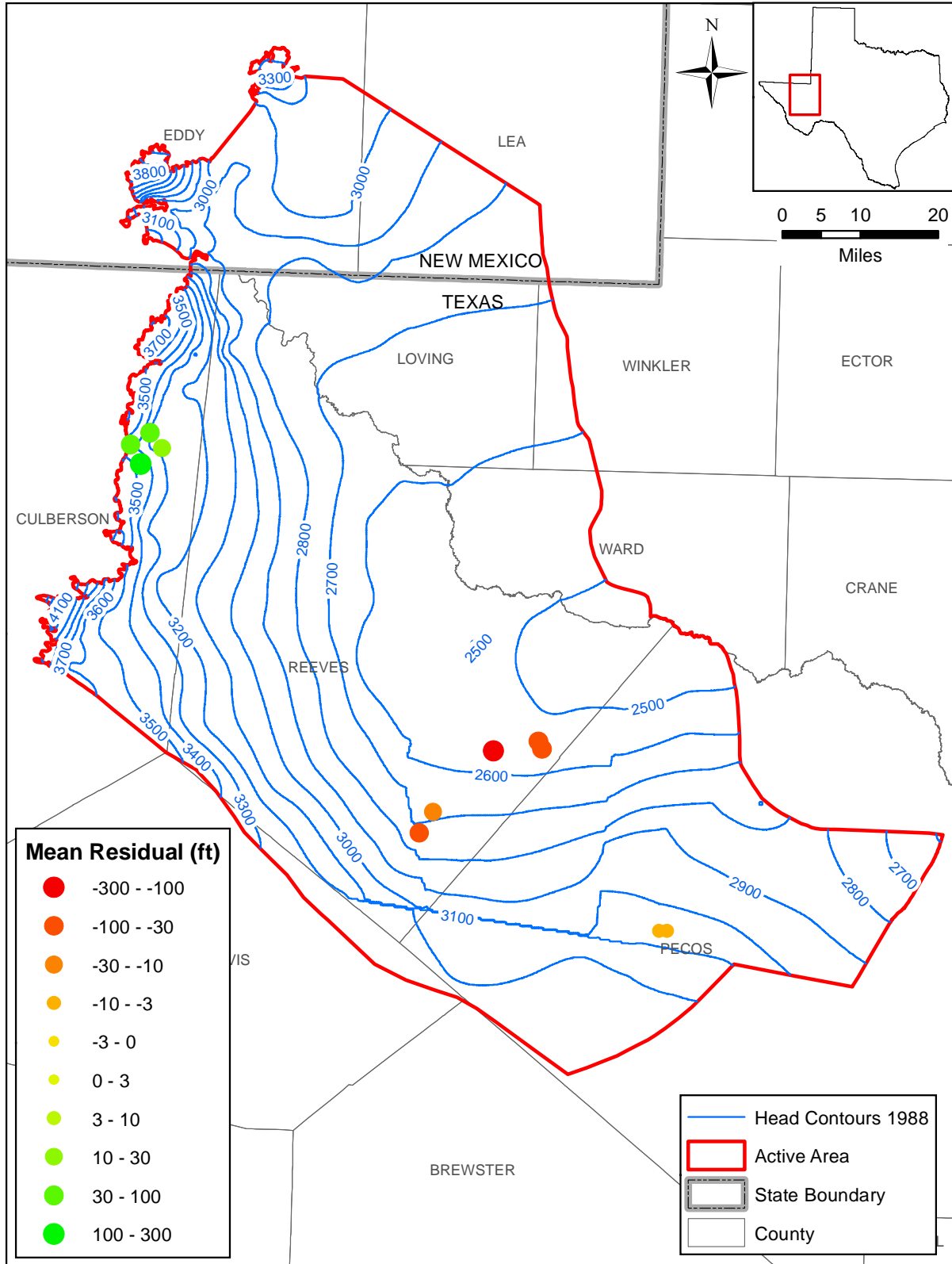

Figure 9.2.6 Simulated water levels and residuals in feet at target wells for the Rustler Aquifer for 1988.

Final Groundwater Availability Model for the Rustler Aquifer

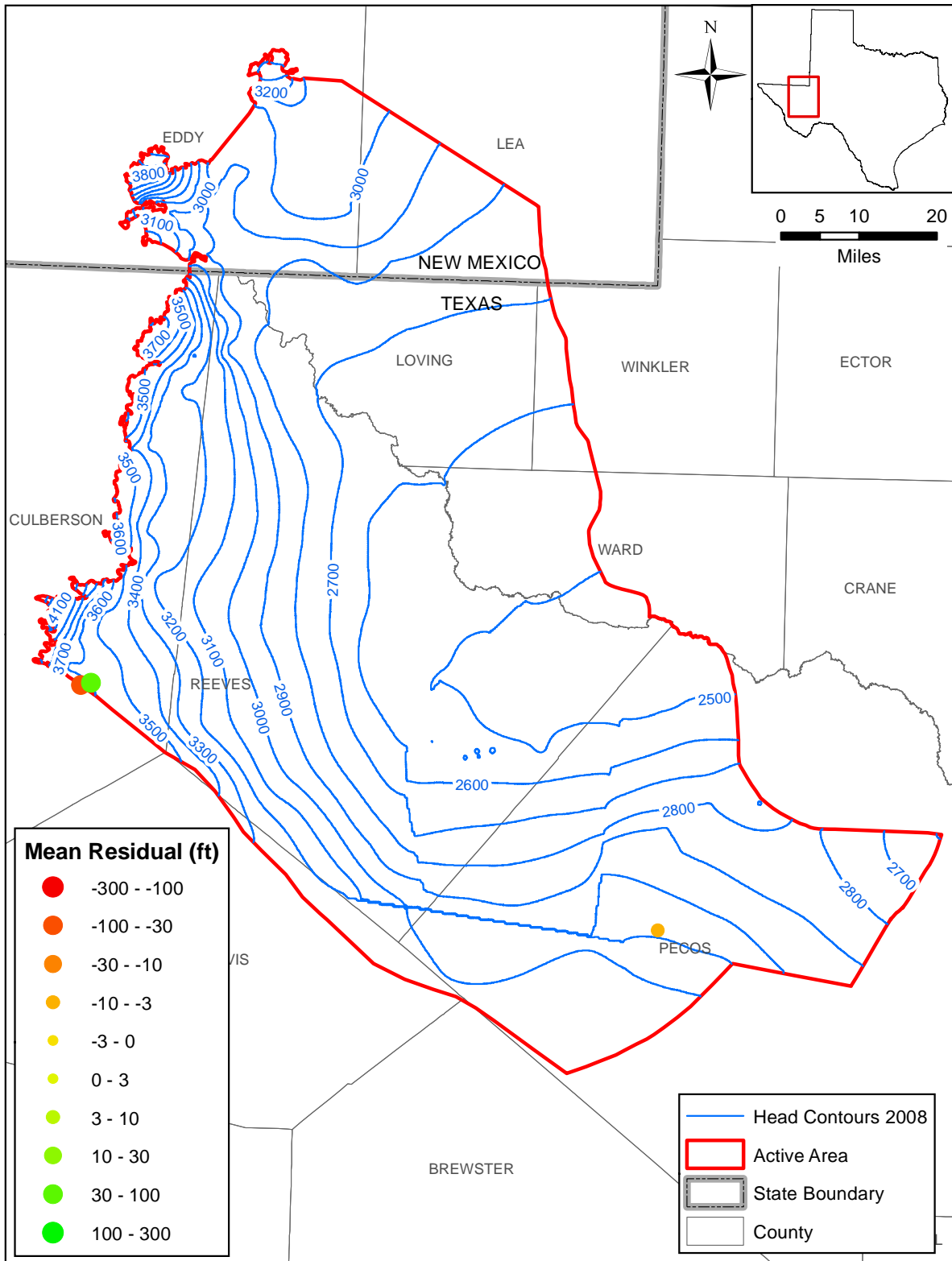

Figure 9.2.7 Simulated water levels and residuals in feet at target wells for the Rustler Aquifer for 2008.

Final Groundwater Availability Model for the Rustler Aquifer

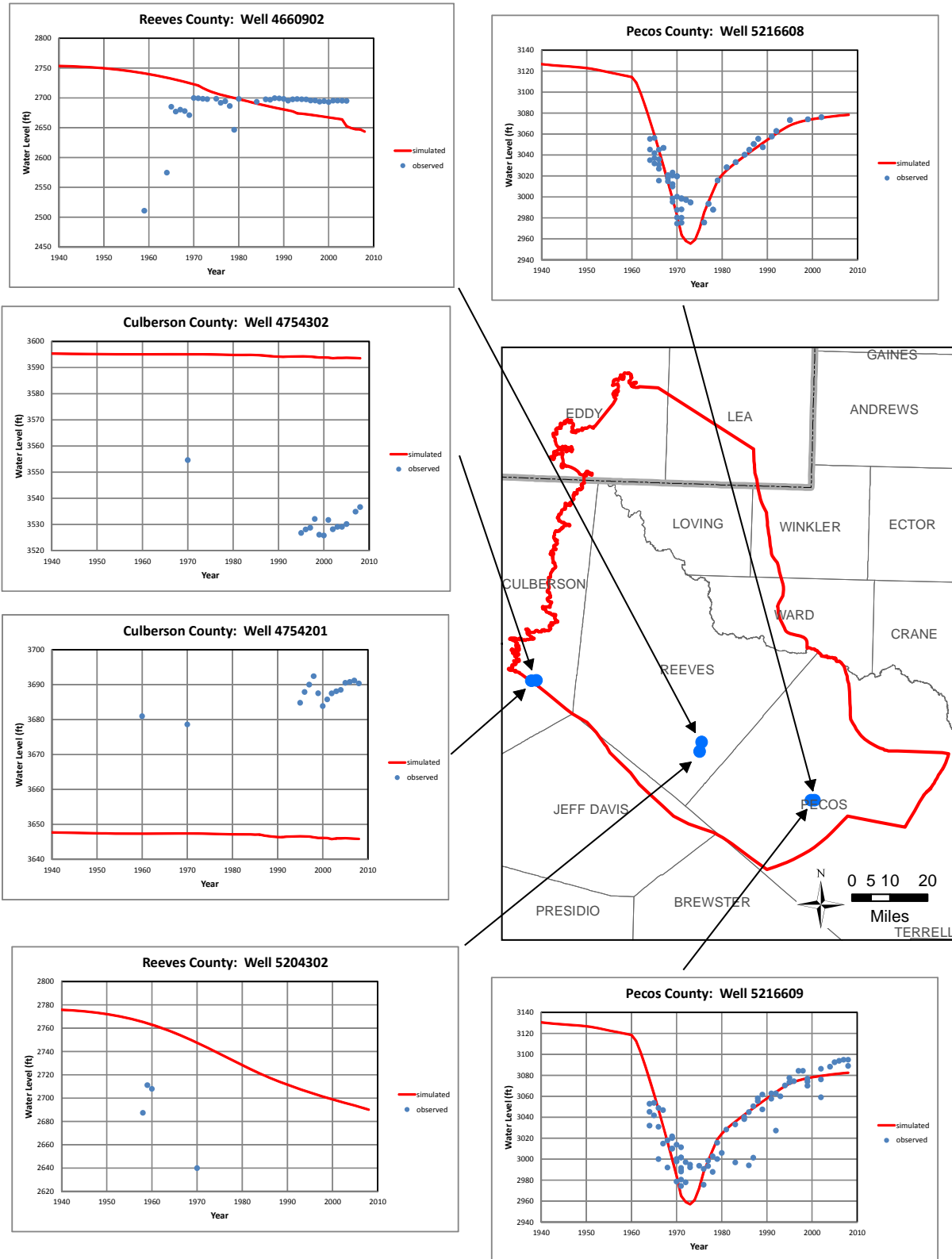

Figure 9.2.8 Hydrographs of simulated (lines) and measured (points) water-level elevations in feet in the Rustler Aquifer.

Final Groundwater Availability Model for the Rustler Aquifer

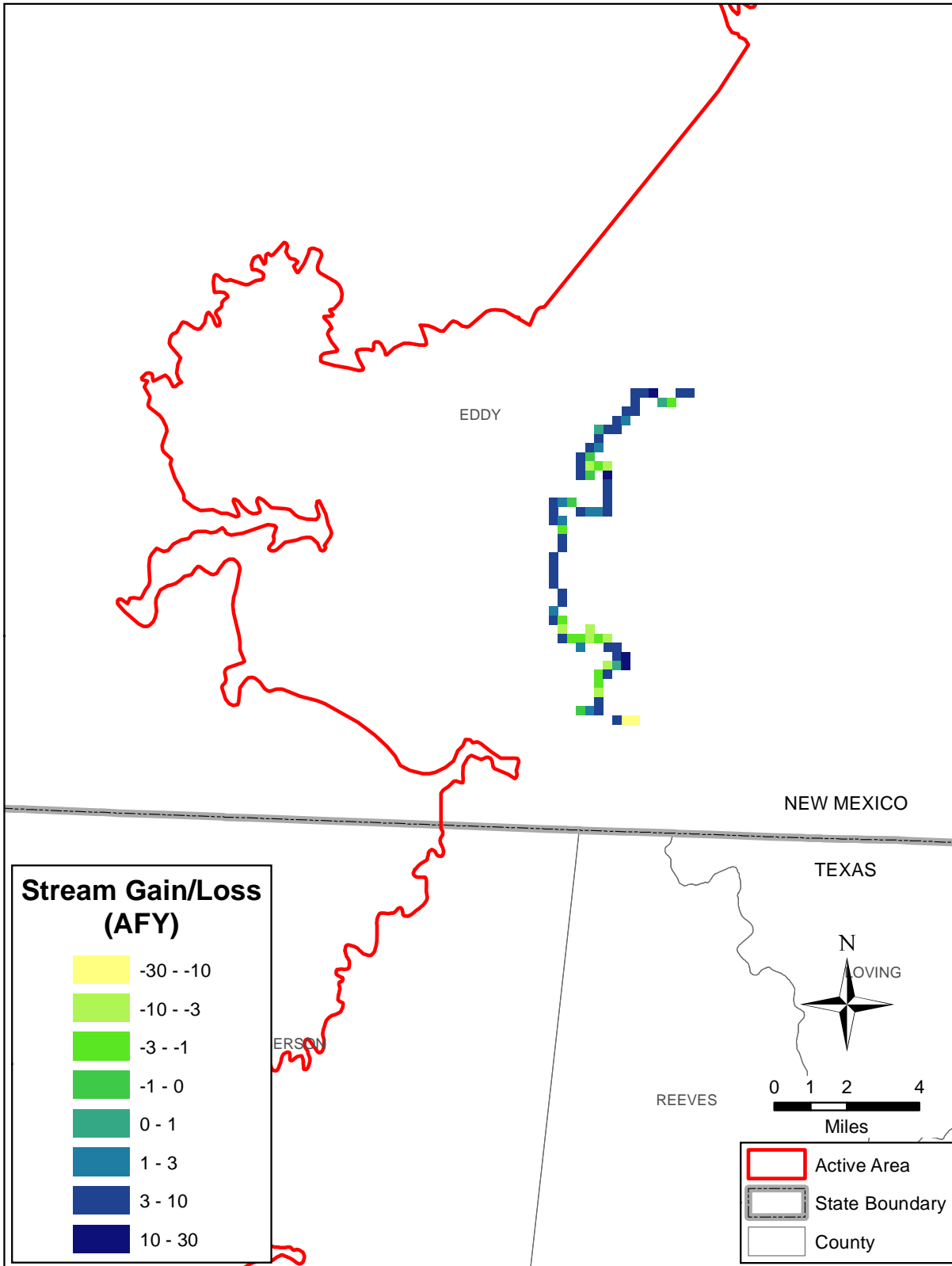

Figure 9.2.9 Simulated stream gain/loss in acre-feet per year for 2008 (negative value indicates gaining stream cell).

Final Groundwater Availability Model for the Rustler Aquifer

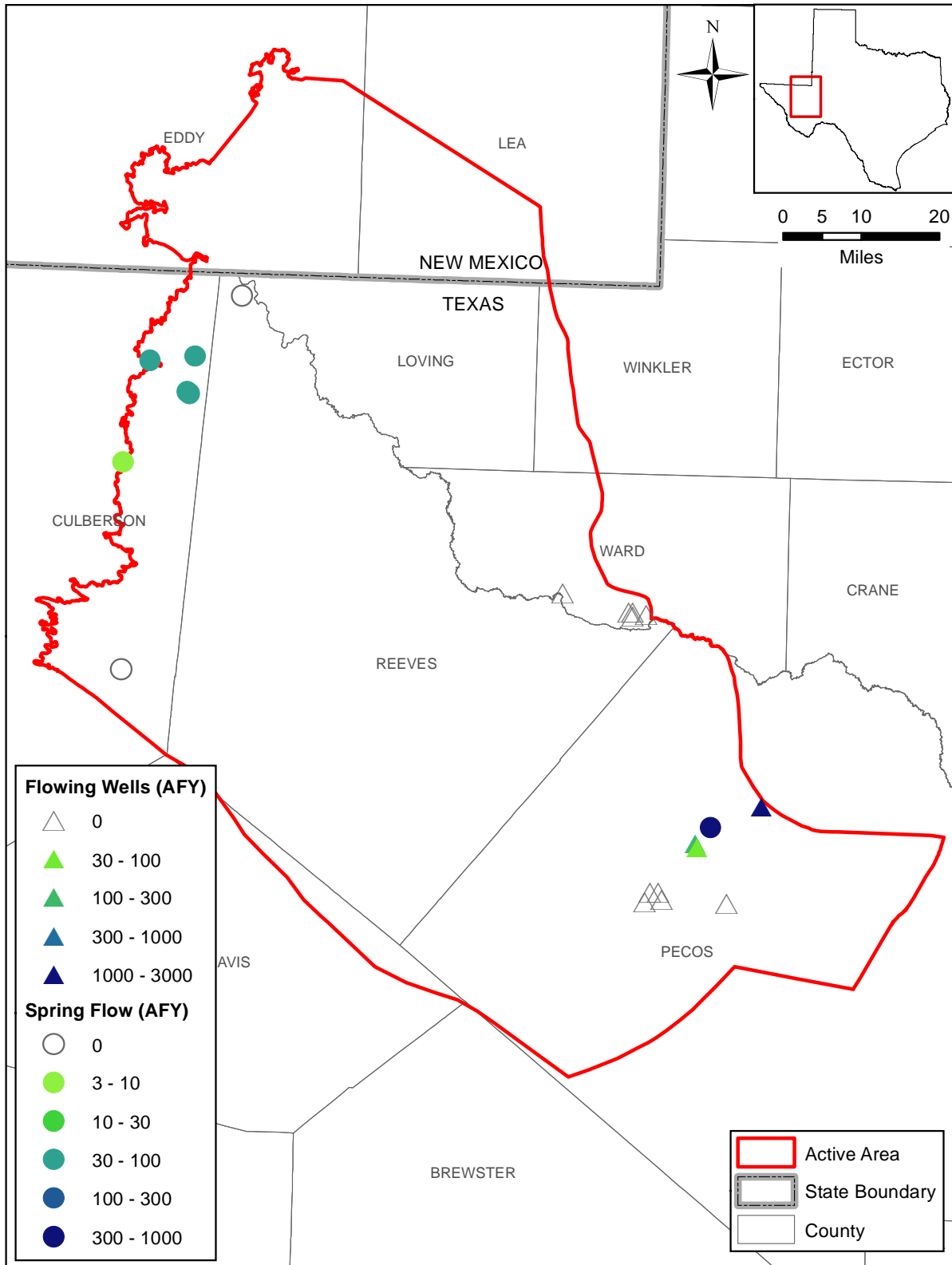

Figure 9.2.10 Simulated spring flow and simulated flow from flowing wells in acre-feet per year for the transient model in 2008.

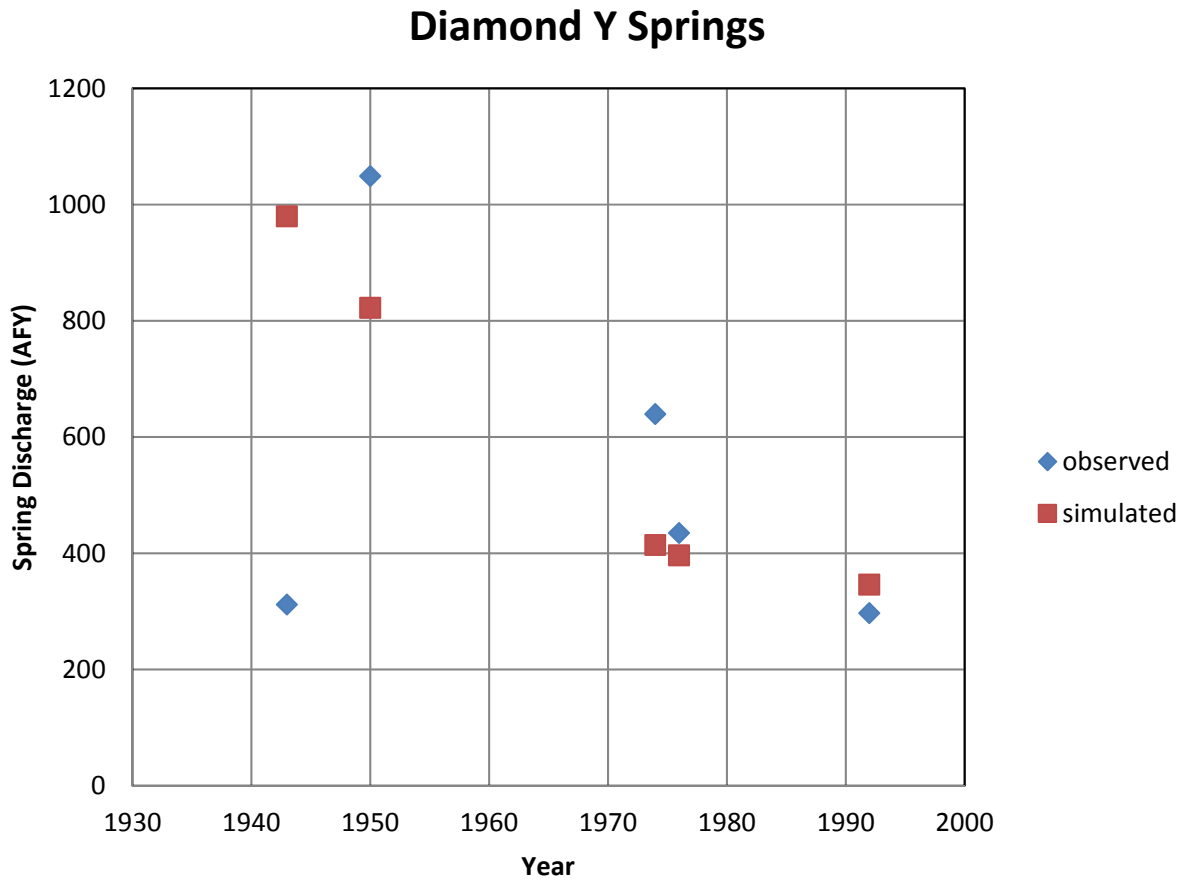

Figure 9.2.11 Simulated and observed discharge at Diamond Y Springs in acre-feet per year for the transient model.

Final Groundwater Availability Model for the Rustler Aquifer

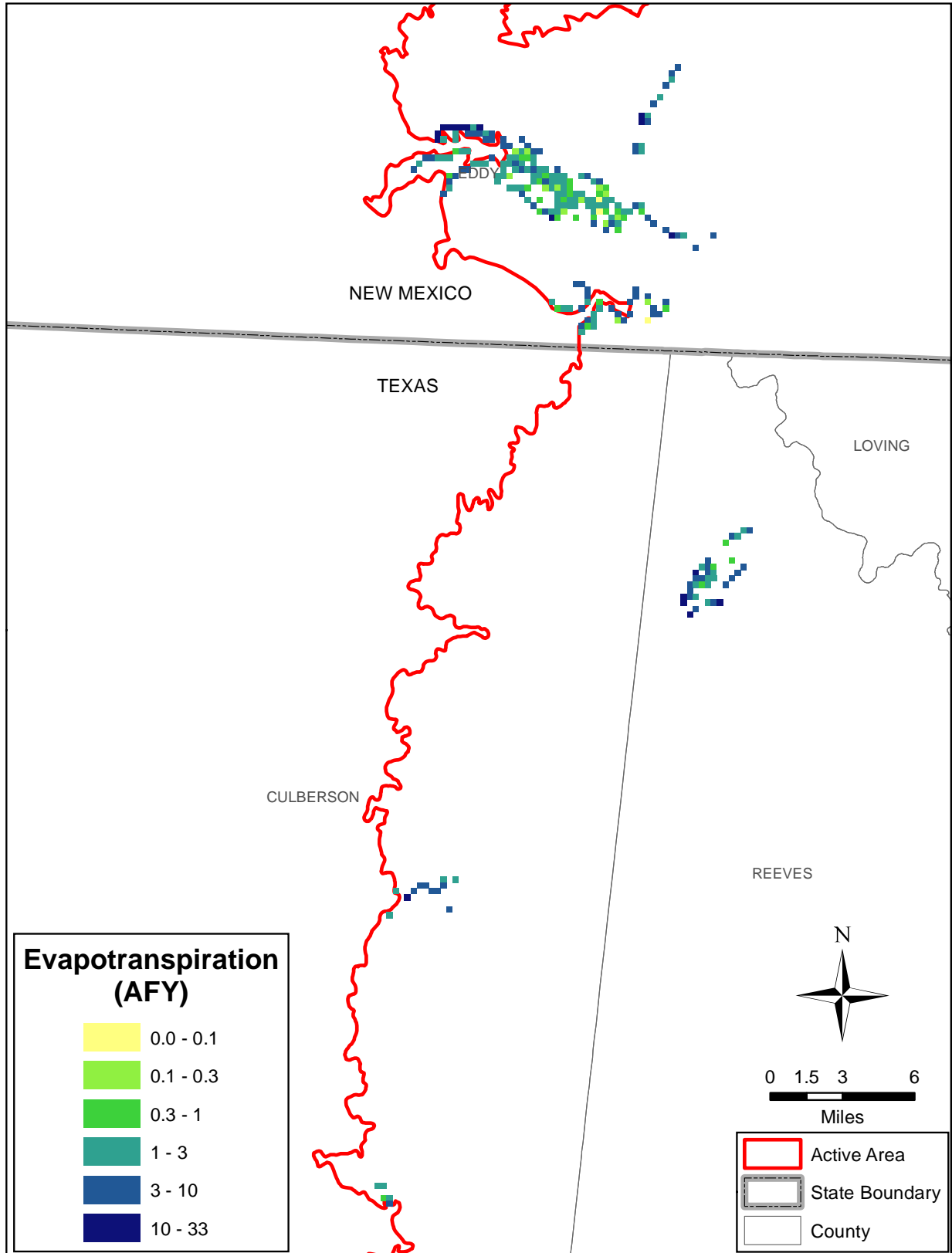

Figure 9.2.12 Simulated evapotranspiration in acre-feet per year for the transient model in 2008.

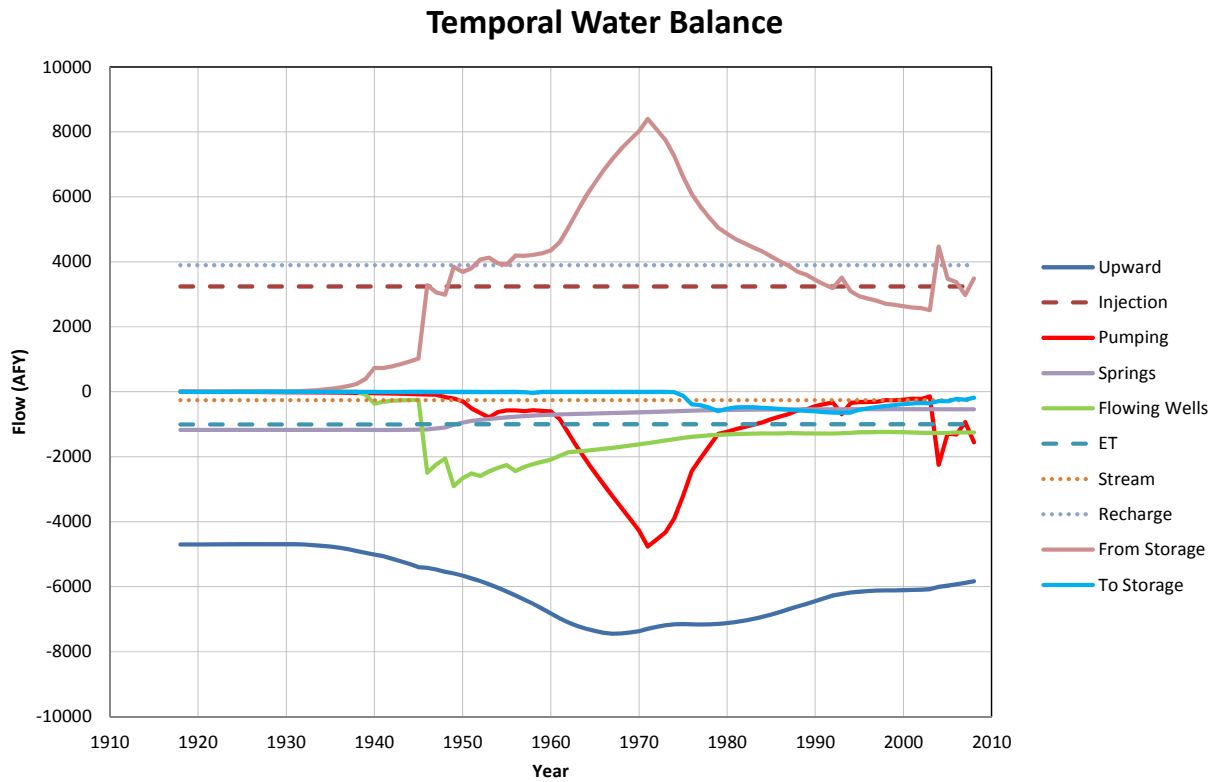

Figure 9.2.13 Time history of water budget in acre-feet per year for the Rustler Aquifer. Positive values denote recharge and negative values denote discharge.

9.3 Sensitivity Analysis

Section 8.3 discusses the approach for sensitivity analyses for the steady-state model. The analyses were similar for the transient model, with the addition of several sensitivities pertinent only to the transient model. For the transient sensitivity analysis, 21 parameter sensitivities were conducted:

1. Horizontal hydraulic conductivity in all layers (K_{hall}),
2. Horizontal hydraulic conductivity in layer 1 (K_{h1}),
3. Horizontal hydraulic conductivity in layer 2 (K_{h2}),
4. Vertical hydraulic conductivity in all layers (K_{vall}),
5. Vertical hydraulic conductivity in layer 1 (K_{v1}),
6. Vertical hydraulic conductivity in layer 2 (K_{v2}),
7. Hydraulic flow barrier conductance (K_{hfb}),
8. Specific storage in all layers (S_{sall}),
9. Specific storage in layer 1 (S_{s1}),
10. Specific storage in layer 2 (S_{s2}),
11. Recharge in outcrop (Recharge),
12. Lateral inflow from Glass and Davis mountains (Lateral),
13. General-head boundary conductance (K_{ghb}),
14. Streambed conductance (K_{strm}),
15. Spring conductance (K_{sprg}),
16. Flowing well conductance (K_{fw}),
17. Pumping (Pumping),
18. General-head boundary elevation (Z_{ghb}),
19. Stream elevation (Z_{strm}),
20. Spring elevation (Z_{sprg}), and
21. Flowing well elevation (Z_{fw}).

Equation 8.3.1 (varying linearly) for parameter variation was used for sensitivities 8 through 12 and 17, Equation 8.3.2 (varying logarithmically) was used for sensitivities 1 through 7 and 13 through 16, and Equation 8.3.3 was used for sensitivities 18 through 21.

As with the steady-state model, the mean difference between the base simulated head and the sensitivity simulated head was calculated by applying Equation 8.3.4 at all grid blocks.

9.3.1 Sensitivity of Simulated Head to Changes in Conductivity

Figure 9.3.1 shows the sensitivity of heads in the Rustler Aquifer to changes in horizontal and vertical hydraulic conductivity and in hydraulic flow barrier conductance. The most sensitive individual parameter is the horizontal hydraulic conductivity of layer 2. Figure 9.3.2 depicts the sensitivity of heads in the Rustler Aquifer to changes in storage parameters. The most sensitive individual parameter is the specific storage in layer 2. Figure 9.3.3 shows the sensitivity of heads in the Rustler Aquifer to changes in recharge and boundary condition conductances. The most sensitive boundary condition parameters are the recharge rate in the Rustler Aquifer outcrop and the general-head boundary conductance. Figure 9.3.4 depicts the sensitivity of heads in the Rustler Aquifer to changes in boundary condition elevation. The most sensitive boundary condition elevation is that of the general-head boundaries representing the Edwards-Trinity (Plateau) and Pecos Valley aquifers.

9.3.2 Sensitivity of Simulated Stream Gain to Changes in Conductivity

Figure 9.3.5 shows the sensitivity of stream gain/loss to changes in horizontal and vertical hydraulic conductivity and in hydraulic flow barrier conductance. By far the most sensitive individual parameter is the horizontal hydraulic conductivity of layer 2. Figure 9.3.6 depicts the sensitivity of stream gain/loss to changes in storage parameters. The stream gain/loss is insensitive to storage parameters. Figure 9.3.7 shows the sensitivity of stream gain/loss to changes in recharge and boundary condition conductances. The most sensitive boundary condition parameter is the recharge rate in the Rustler Aquifer outcrop followed by the streambed conductance. Figure 9.3.8 depicts the sensitivity of stream gain/loss to changes in boundary condition elevations. The most sensitive parameter is the elevation of the stream itself.

9.3.3 Sensitivity of Simulated Spring Flow to Changes in Conductivity

Figure 9.3.9 shows the sensitivity of spring flow to changes in horizontal and vertical hydraulic conductivity and in hydraulic flow barrier conductance. By far the most sensitive individual parameter is the horizontal hydraulic conductivity of layer 2. Figure 9.3.10 depicts the sensitivity of spring flow to changes in storage parameters. The most sensitive individual

parameter is the specific storage in layer 2. Figure 9.3.11 shows the sensitivity of spring flow to changes in recharge and boundary condition conductances. The most sensitive boundary condition parameters are the recharge rate in the Rustler Aquifer outcrop and the conductance of the general-head boundaries. The spring flows are also sensitive to spring conductance and to lateral inflow from the Glass and Davis mountains. Figure 9.3.12 depicts the sensitivity of spring flow to changes in boundary condition elevations. The most sensitive parameters are the elevation of the springs themselves and the elevation of the general-head boundary.

9.3.4 Sensitivity of Flowing Well Flow to Changes in Conductivity

Figure 9.3.13 shows the sensitivity of flowing well flow to changes in horizontal and vertical hydraulic conductivity and in hydraulic flow barrier conductance. By far the most sensitive individual parameter is the horizontal hydraulic conductivity of layer 2. Figure 9.3.14 depicts the sensitivity of flowing well flow to changes in storage parameters. The most sensitive individual parameter is the specific storage in layer 2. Figure 9.3.15 shows the sensitivity of flowing well flow to changes in recharge and boundary condition conductances. The most sensitive boundary condition parameter is the lateral inflow from the Glass and Davis mountains. The flowing well flows are also sensitive to pumping, general-head boundary conductance, and spring conductance. Figure 9.3.16 depicts the sensitivity of flowing well flow to changes in boundary condition elevations. The most sensitive parameters are the elevation of the flowing wells and the elevation of the general-head boundary.

The hydrostructural subdomains of the Rustler Aquifer are largely hydraulically isolated from one another. The sensitivity of simulated heads in a given subdomain to model-wide changes in parameters is, therefore, instructive since it is indicative of the sensitivity of heads to changes in parameters within that subdomain. Plots of the sensitivity of mean heads within individual subdomains are included in Appendix A with Figures A.4 through A.7 pertaining to the transient model.

9.3.5 Sensitivity of Hydrographs to Changes in Conductivity

Figure 9.3.17 depicts the transient sensitivity of heads for each of the hydrographs when horizontal hydraulic conductivity of the Rustler Aquifer is varied. Generally, increases in the horizontal hydraulic conductivity result in decreases in the simulated heads. However, in areas with concentrated pumping, decreases in horizontal hydraulic conductivity result in increased

drawdown and lower head during the periods when pumping rates are high. The heads at wells in Culberson and Pecos counties are relatively sensitive to changes in hydraulic conductivity while the heads at wells in Reeves County are relatively insensitive. This is because Culberson County is impacted by direct recharge and Pecos County is impacted by concentrated pumping while Reeves County has comparatively smaller inflows and outflows.

9.3.6 Sensitivity of Hydrographs to Changes in Storage

The transient sensitivity of heads at hydrographs to changes in storage parameters of the Rustler Aquifer is shown in Figure 9.3.18. The heads at wells in Culberson County are in the outcrop and show very little sensitivity changes in specific yield. Within Reeves County, heads are insensitive to changes in storativity at early times but show an increasing sensitivity over time. This may be an effect of a small amount of livestock pumping that is applied in the deep portion of subdomain 9 within Reeves County. The heads at the wells in Pecos County are sensitive to changes in storativity during periods of high pumping or recovery but are insensitive at other times.

9.3.7 Sensitivity of Hydrographs to Changes in Recharge

Figure 9.3.19 shows the transient sensitivity of heads for each of the hydrographs when recharge in the Rustler Aquifer outcrop is varied. Heads at wells in Culberson County are in the outcrop and are very sensitive to changes in recharge with increased recharge causing increased heads. The heads at wells in the Rustler Aquifer subcrop in Reeves and Pecos counties are insensitive to changes in recharge.

9.3.8 Sensitivity of Hydrographs to Changes in Lateral Inflow

Figure 9.3.20 shows the transient sensitivity of heads for each of the hydrographs when the lateral inflow from the Glass and Davis mountains is varied. The wells in Culberson County are located near the inflow boundary from the Davis Mountains and the heads there are sensitive to changes in the inflow from that boundary. Increased inflows lead to increased heads. Similarly, the heads at the wells in Pecos County are sensitive to changes in the lateral boundary inflow because they are proximal to the Glass Mountains. In contrast, the heads at wells in Reeves County are insensitive to changes in the lateral boundary inflow. Recall from Section 6.3.4 that the lateral inflows were transmissivity weighted along a given boundary segment. This, coupled

with the low hydraulic conductivities in the deep portion of subdomain 9, results in low inflow rates into the Rustler Aquifer in the vicinity of the wells in Reeves County and an associated insensitivity to changes in those rates.

9.3.9 Sensitivity of Hydrographs to Changes in Pumping

Figure 9.3.21 shows the transient sensitivity of heads for each of the hydrographs when pumping is varied. As discussed in Section 9.1.3, the heads at the wells in Pecos County are influenced by pumping. Accordingly, the heads at those wells are sensitive to pumping at times when pumping discharge is high. Because very little pumping occurs in the vicinity of the wells in Reeves and Culberson counties, the heads at these wells are insensitive to pumping.

9.3.10 Sensitivity to Specific Underestimates in Pumping

Inaccuracies in estimated pumping can have a dramatic impact on the simulated behavior of water levels in the Rustler Aquifer. An attempt to recognize and ameliorate this fact was made and discussed in Section 9.1.3 with the addition of pumping based on documented permitted pumping in the Belding Farms area of subdomain 4b. Other regions of the Rustler Aquifer where no documented allocated pumping exists may also be impacted by an underestimate of pumping, however. This section identifies areas of the Rustler Aquifer where observed water levels indicate that pumping may be underestimated. Rather than including an ill-constrained underestimate of pumping into the transient model, this probable underestimate of pumping is treated as an alternative model. The effects of hypothetical pumping are described and illustrated and the alternative MODFLOW well package is included in the delivered model files.

As shown in Figure 5.0.1, hydrostructural subdomain 7b is relatively isolated from the surrounding subdomains by faults with large displacements. The observed pre-development heads in subdomains 4b, 5, and 9 which surround subdomain 7b are higher than those observed in subdomain 7b. Similarly, the observed pre-development heads in subdomains 8 and 10 which surround subdomain 7a are higher than those observed in subdomain 7a. The pre-development conceptual model, therefore, assumes that the only available outlet for discharge from subdomains 7b and 7a is upward through the Dewey Lake and Dockum confining units into the Edwards-Trinity (Plateau) and Pecos Valley aquifers. Figure 4.3.13, on the other hand, indicates that observed heads at several wells in the Rustler Aquifer are actually lower than observed heads in proximal wells completed in the Dockum Aquifer following development of the Rustler

Aquifer and the Edwards-Trinity (Plateau) and Pecos Valley aquifers. The transient model of the Rustler Aquifer, however, shows simulated heads in the Rustler Aquifer being higher than those representing the Dockum Aquifer. The most likely explanation for this discrepancy is thought to be an underestimate of pumping in the Rustler Aquifer in portions of subdomains 7b and 7a. To test this hypothesis, simulations including what are considered to be moderate amounts of additional pumping in wells in subdomains 7b and 7a (600 acre-feet per year total pumping allocated equally at three wells) were conducted. The results of these simulations compared to the results of the transient model are shown in Figure 9.3.22.

Unlike the similar hypothesis of an underestimate of pumping being corrected in subdomain 4b based on reported permits for pumping in the Belding Farms area, there is no data source with which to constrain the amount of pumping that is likely underestimated in subdomains 7b and 7a. Therefore, the hypothetical scenario of additional pumping shown in Figure 9.3.22 is poorly constrained by the available information and can only be considered a possible scenario. To illustrate the effect of additional pumping, this scenario is included in the delivered model files as an alternative model.

9.3.11 Long-term Sensitivity to Vertical Hydraulic Conductivity

Analogous to the impact of an underestimate of pumping on the simulated transient model results, assumptions influencing the impact of the overlying Edwards-Trinity (Plateau) and Pecos Valley aquifers on the water levels in the Rustler Aquifer may have a profound impact on the simulated heads in the Rustler Aquifer. These assumptions include both the water levels applied as general-boundary conditions representing the Edwards-Trinity (Plateau) and Pecos Valley aquifers and the conductance parameters meant to represent the vertical hydraulic conductivity of the Dewey Lake and Dockum units. A considerable effort was conducted to best represent the transient water levels in the Edwards-Trinity (Plateau) and Pecos Valley aquifers. The resulting implementation is described in Section 6.3.2. The hydraulic conductivity parameters, which affect both the vertical hydraulic conductivity of layer 1 and the general-head boundary conductances applied to layer 1, were based on the vertical hydraulic conductivity parameters reported for the Dockum Aquifer GAM (Ewing and others, 2008). The uncertainty in the calibrated vertical hydraulic conductivity of the Dockum Aquifer may range by an order of

calibrated vertical hydraulic conductivity of the Dockum Aquifer may range by an order of magnitude, however. Since the Dewey Lake Formation is considered to be less conductive than the Dockum Formation, the actual vertical conductivity of the combined Dewey Lake and Dockum formations can be expected to be lower than that of the Dockum Formation alone.

An alternative model of the impact of the vertical hydraulic conductivity of the Dewey Lake and Dockum formations on the cross-formational flow between the Rustler Aquifer and the Edwards-Trinity (Plateau) and Pecos Valley aquifers is investigated here. The long-term simulated results of reducing the vertical hydraulic conductivity of the Dewey Lake and Dockum formations by an order of magnitude is shown in Figure 9.3.23 along with the results from the calibrated Rustler Aquifer GAM. A reduction of the vertical hydraulic conductivity of the Dewey Lake and Dockum formations results both in a shallower simulated drawdown in Rustler Aquifer heads when no Rustler pumping is applied (less impact from the declined heads in the Edwards-Trinity (Plateau) and Pecos Valley aquifers) and a steeper simulated drawdown in Rustler Aquifer heads when the pumping from 2008 (a total of 1,555 acre-feet per year) is simply extrapolated for several hundred years. Because the vertical hydraulic conductivity of the Dewey Lake and Dockum formations is poorly constrained by data or numerical modeling, this lower conductivity case is considered a conservative alternative model. The simulated results of this alternative model are shown alongside the results of the calibrated transient model in Figure 9.3.23. The alternative upstream-weighting package and general-head boundary condition package alongside the calibrated model files are included in the delivered model files. Table 9.3.1 shows the impact of the reduced vertical hydraulic conductivity of the Dewey Lake and Dockum formations on the model calibration. The calibration is detrimentally effected to a small degree but the calibration statistics are still within the range of the acceptable groundwater availability model standard.

Table 9.3.1 Sensitivity of calibration statistics to vertical hydraulic conductivity of Dockum.

Case	Number of Targets	ME (feet)	MAE (feet)	RMS (feet)	Range (feet)	Adjusted MAE
Calibrated	231	10.0	40.2	59.9	1794	0.022
Reduced Kv	231	41.2	61.7	87.2	1794	0.034

ME = mean error

MAE = mean absolute error

RMS = root mean square

Final Groundwater Availability Model for the Rustler Aquifer

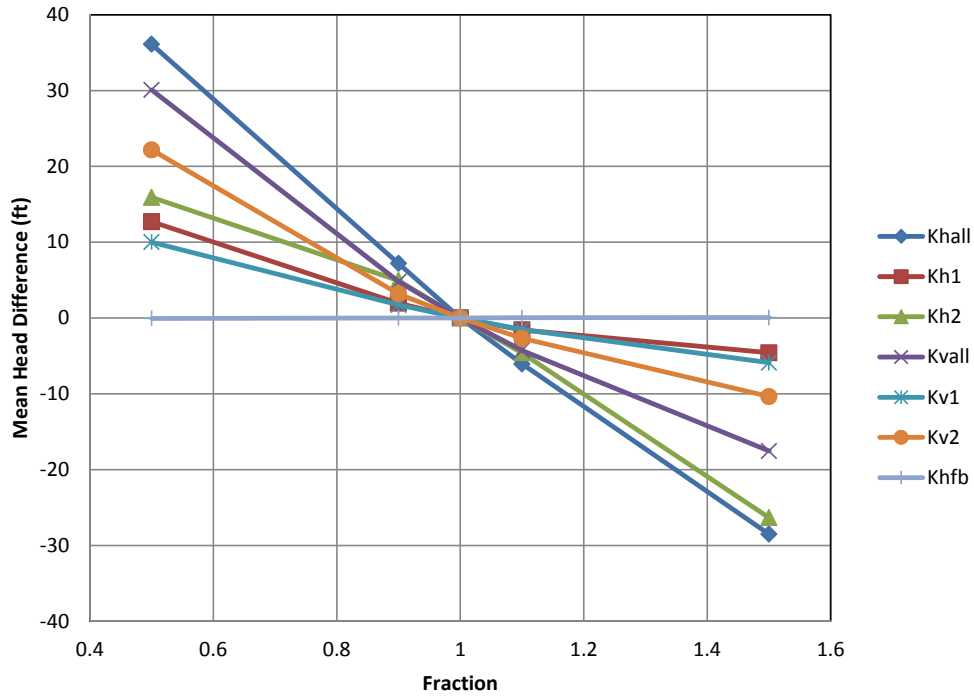

Figure 9.3.1 Transient sensitivity of heads in feet to changes in hydraulic conductivities.

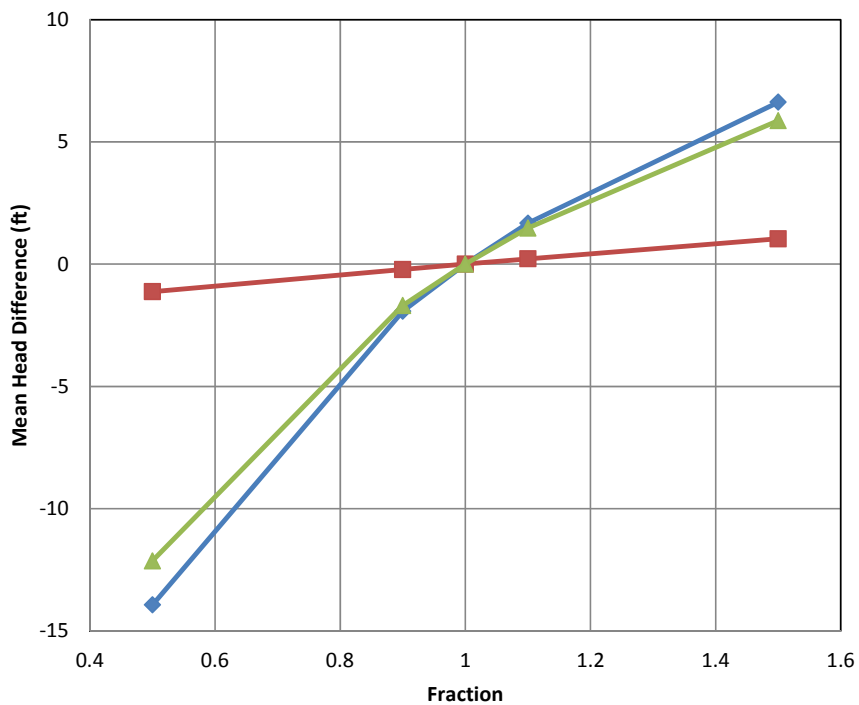

Figure 9.3.2 Transient sensitivity of heads in feet to changes in storage parameters.

Final Groundwater Availability Model for the Rustler Aquifer

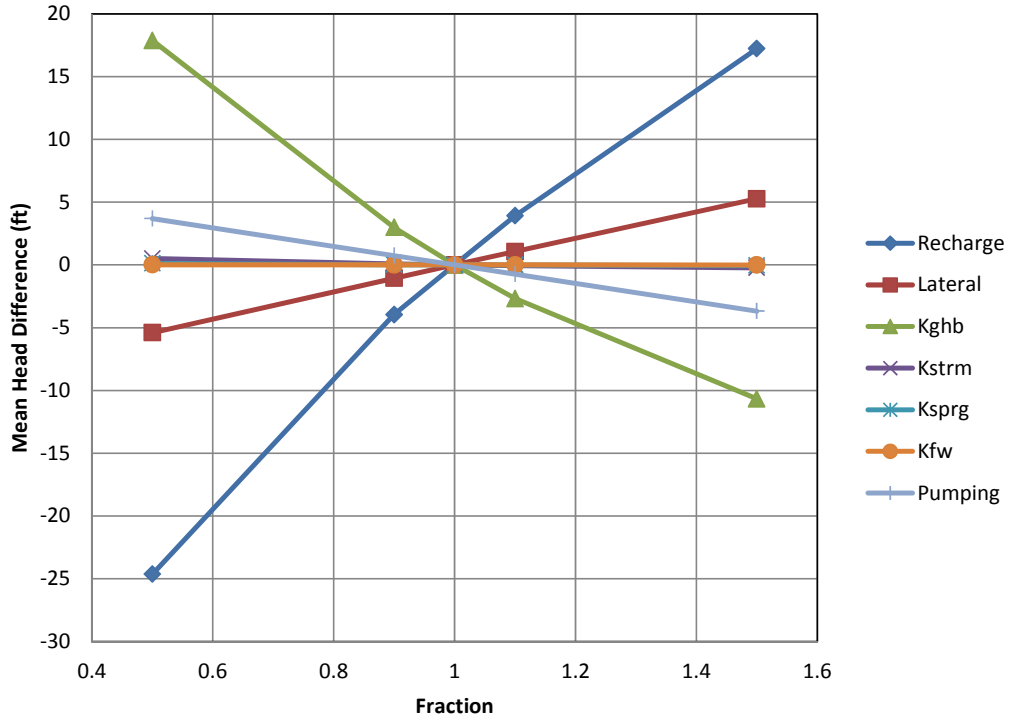

Figure 9.3.3 Transient sensitivity of heads in feet to changes in boundary condition flows and conductances.

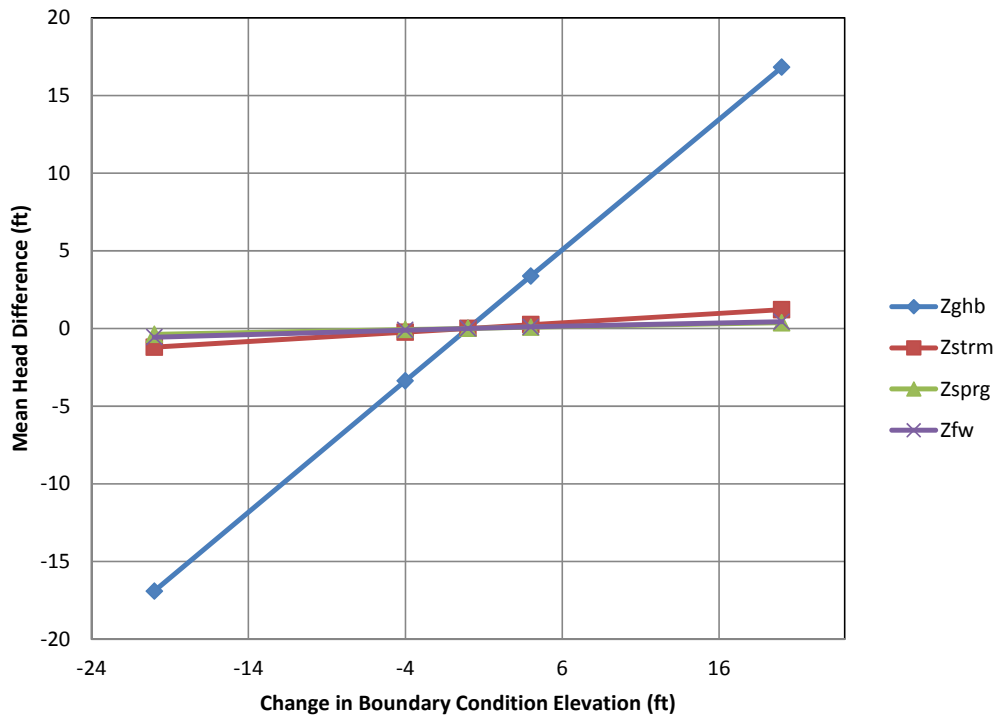

Figure 9.3.4 Transient sensitivity of heads in feet to changes in boundary condition elevations.

Final Groundwater Availability Model for the Rustler Aquifer

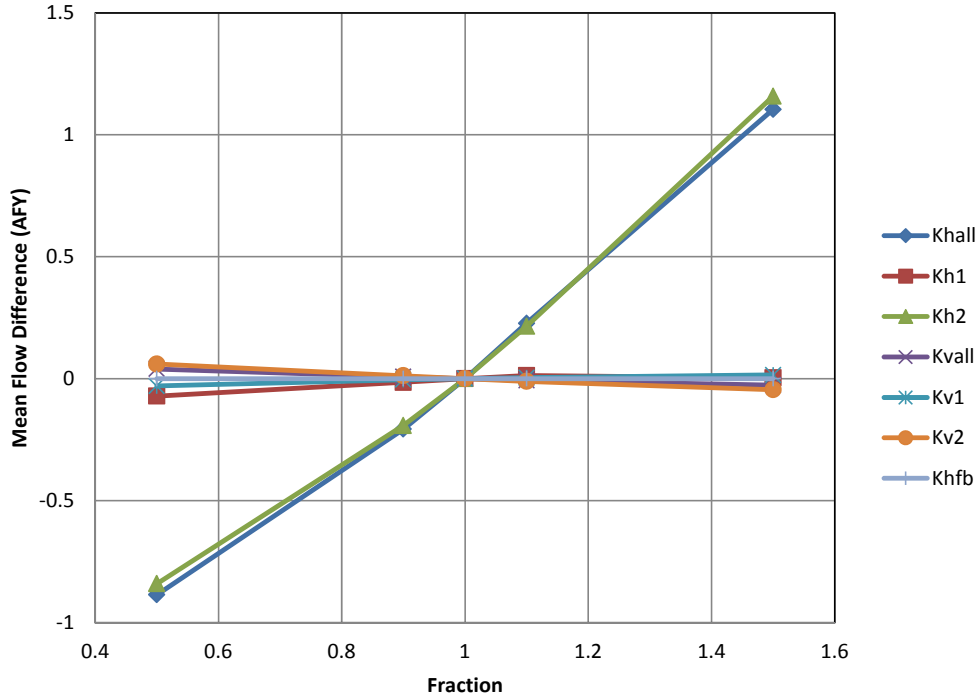

Figure 9.3.5 Transient sensitivity of stream gain/loss in acre-feet per year to changes in hydraulic conductivities.

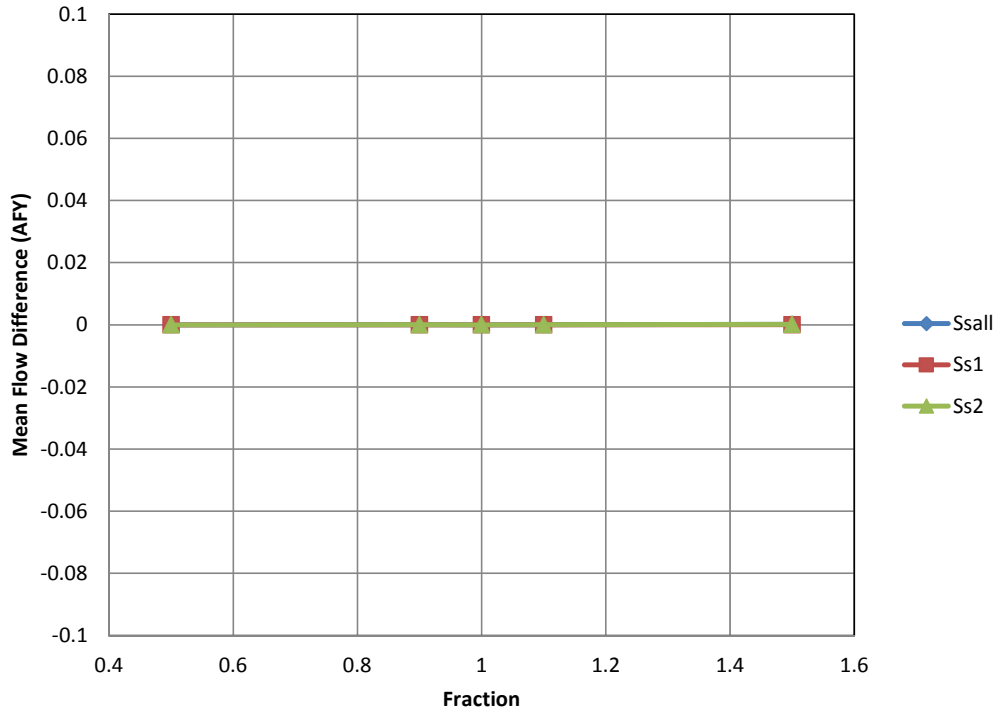

Figure 9.3.6 Transient sensitivity of stream gain/loss in acre-feet per year to changes in storage parameters.

Final Groundwater Availability Model for the Rustler Aquifer

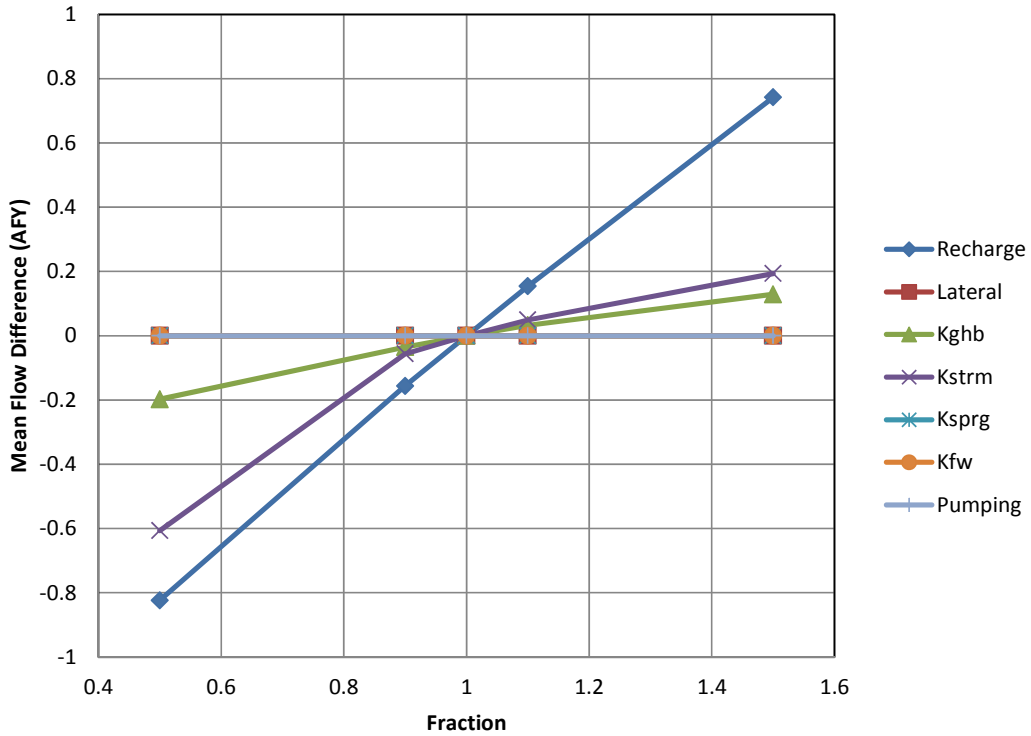

Figure 9.3.7 Transient sensitivity of stream gain/loss in acre-feet per year to changes in boundary condition flows and conductances.

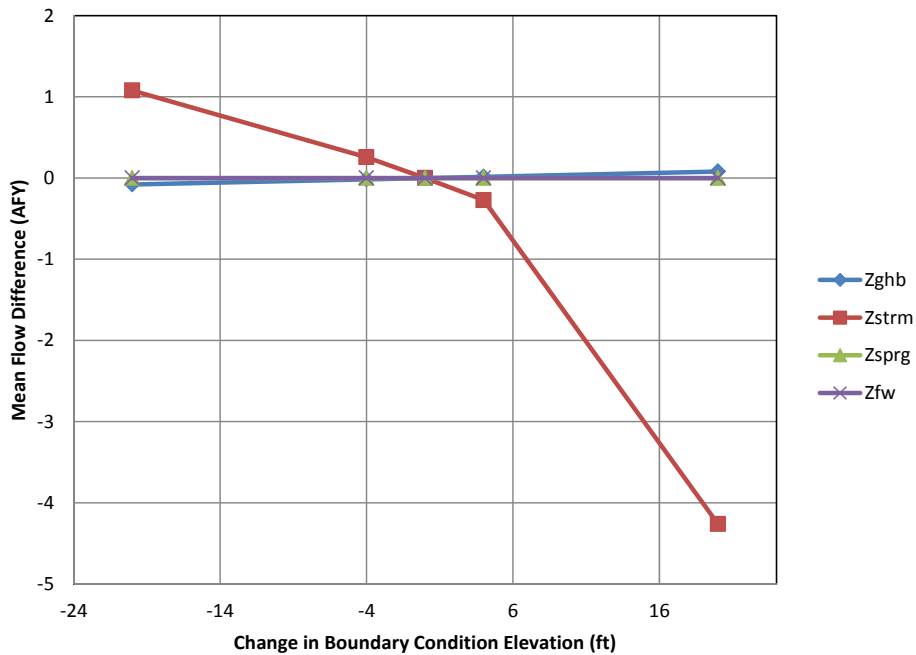

Figure 9.3.8 Transient sensitivity of stream gain/loss in acre-feet per year to changes in boundary condition elevations.

Final Groundwater Availability Model for the Rustler Aquifer

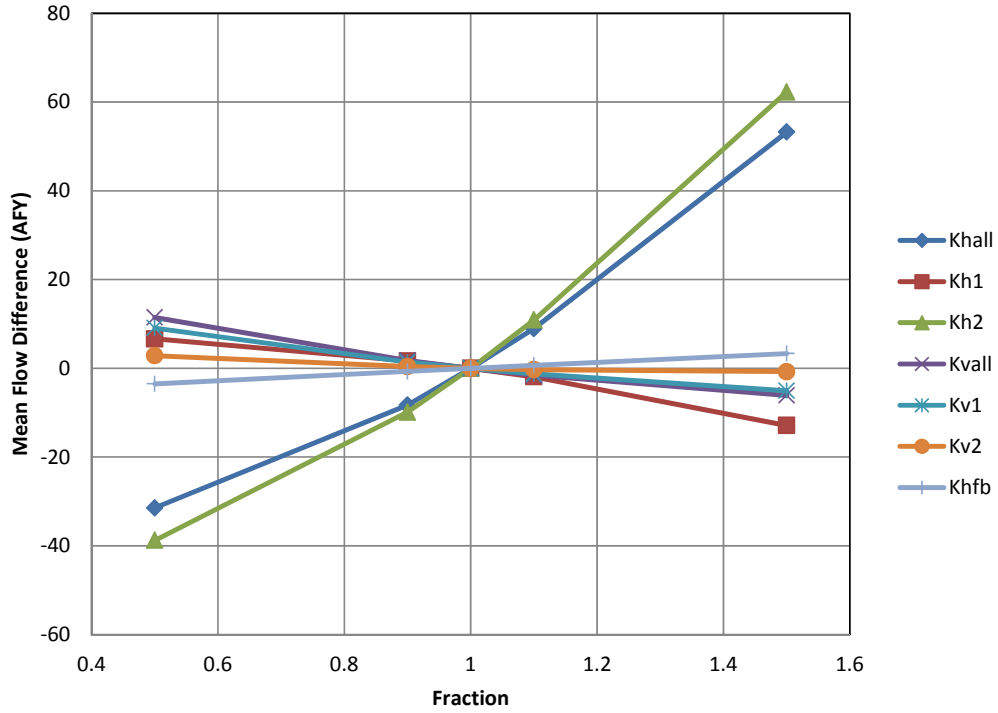

Figure 9.3.9 Transient sensitivity of spring flow in acre-feet per year to changes in hydraulic conductivities.

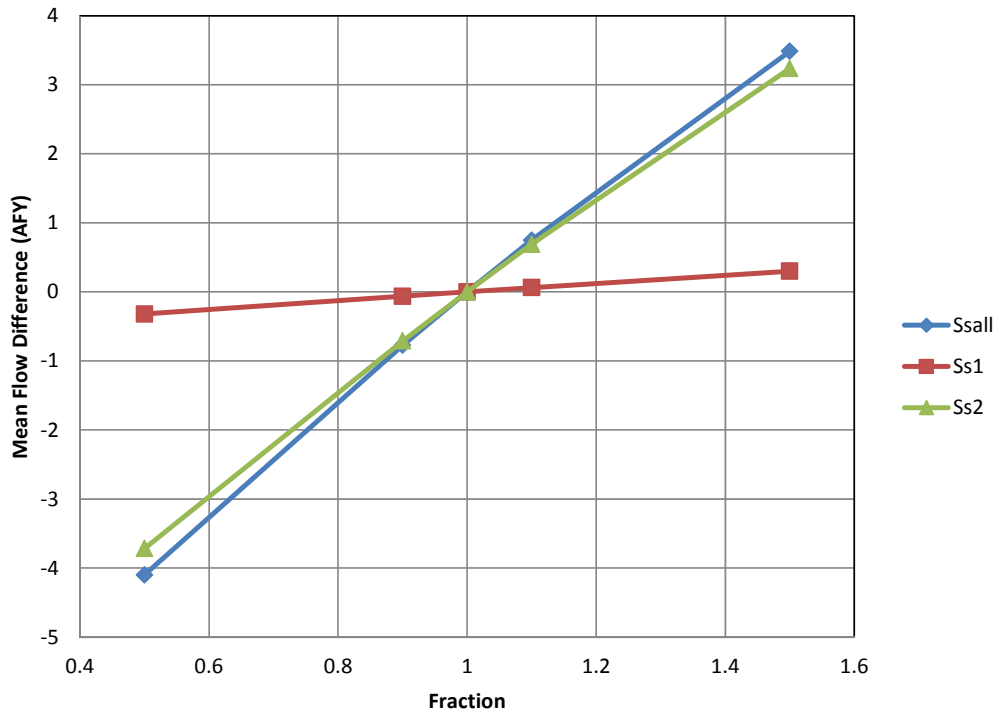

Figure 9.3.10 Transient sensitivity of spring flow in acre-feet per year to changes in storage parameters.

Final Groundwater Availability Model for the Rustler Aquifer

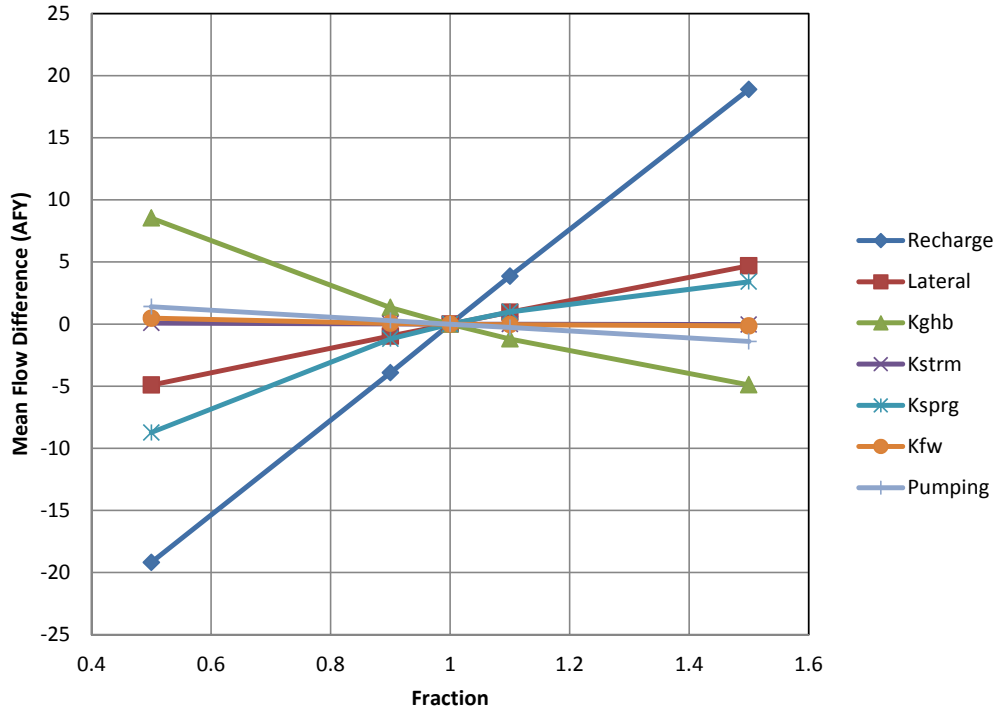

Figure 9.3.11 Transient sensitivity of spring flow in acre-feet per year to changes in boundary condition flows and conductances.

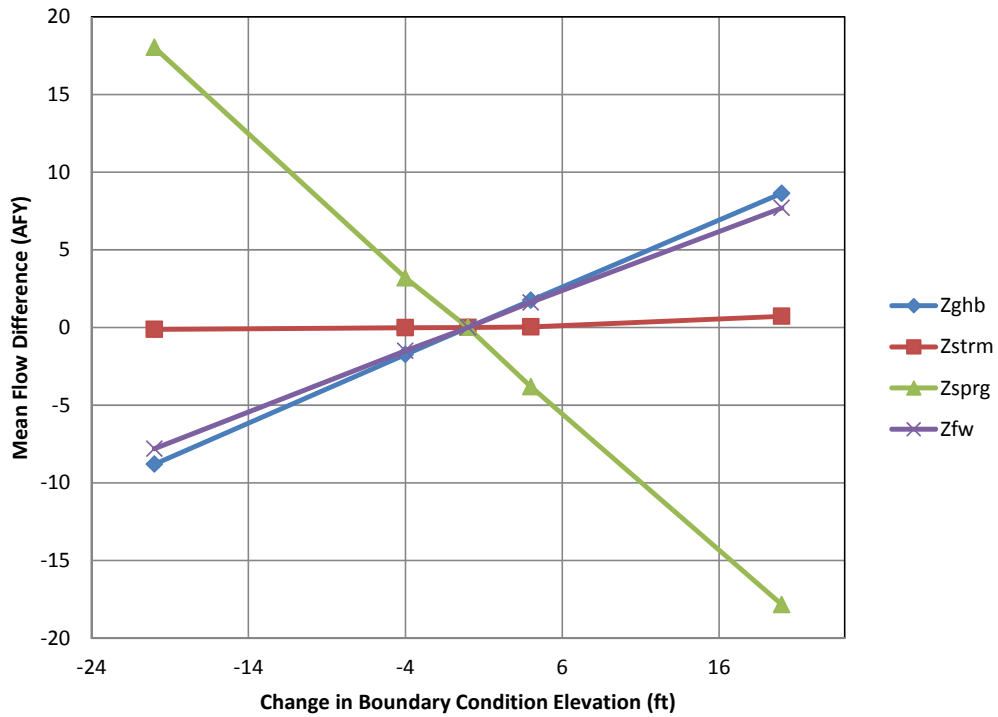

Figure 9.3.12 Transient sensitivity of spring flow in acre-feet per year to changes in boundary condition elevations.

Final Groundwater Availability Model for the Rustler Aquifer

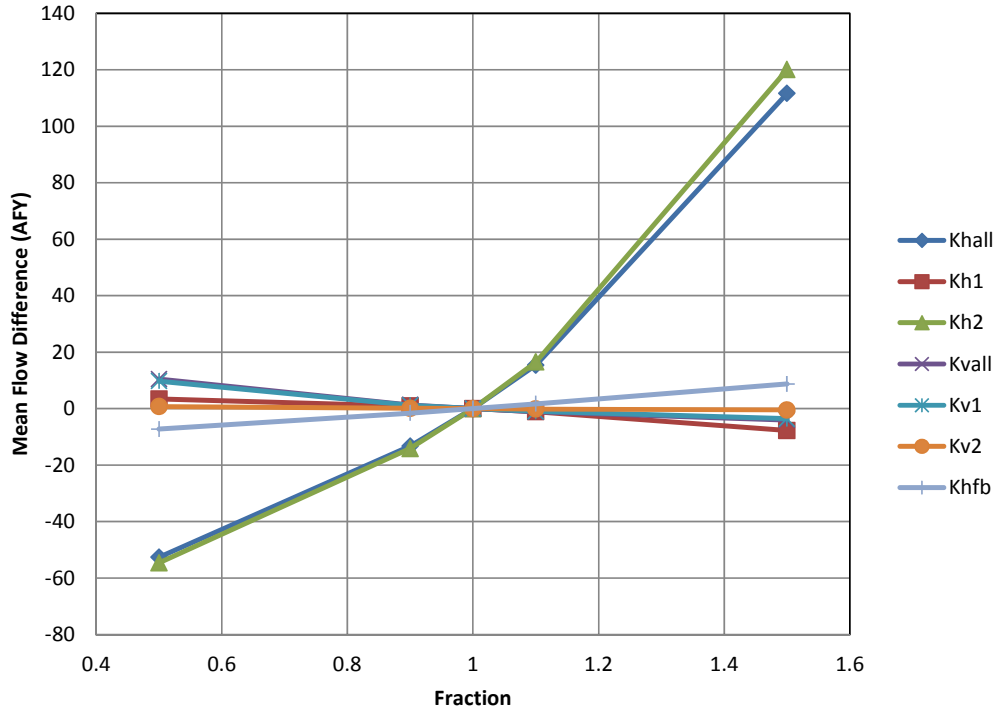

Figure 9.3.13 Transient sensitivity of flowing well flow in acre-feet per year to changes in hydraulic conductivities.

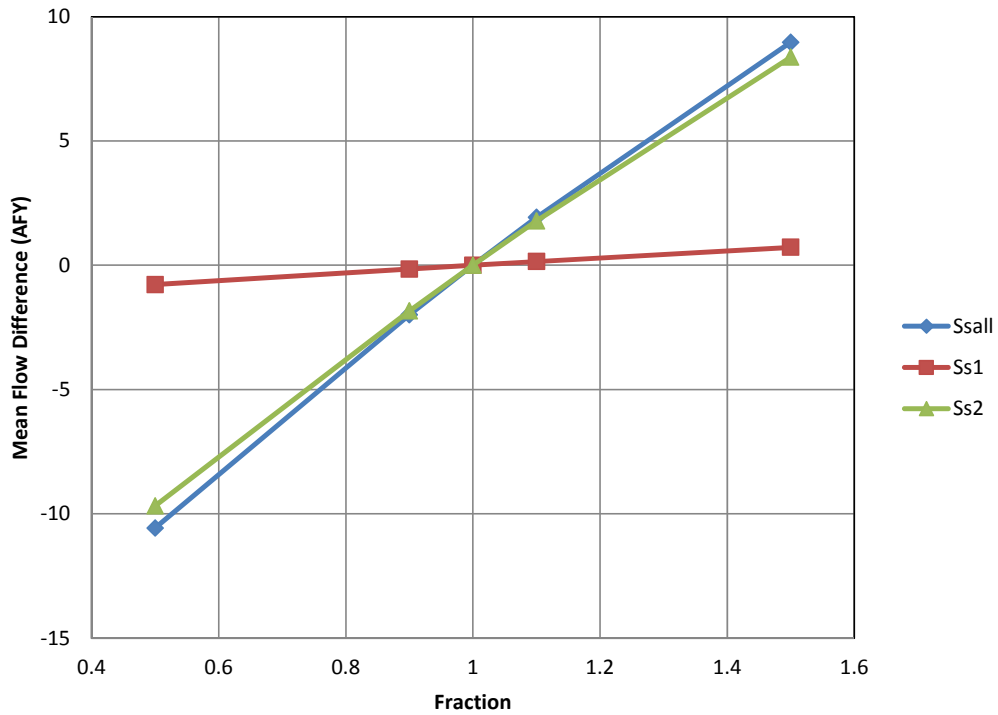

Figure 9.3.14 Transient sensitivity of flowing well flow in acre-feet per year to changes in storage parameters.

Final Groundwater Availability Model for the Rustler Aquifer

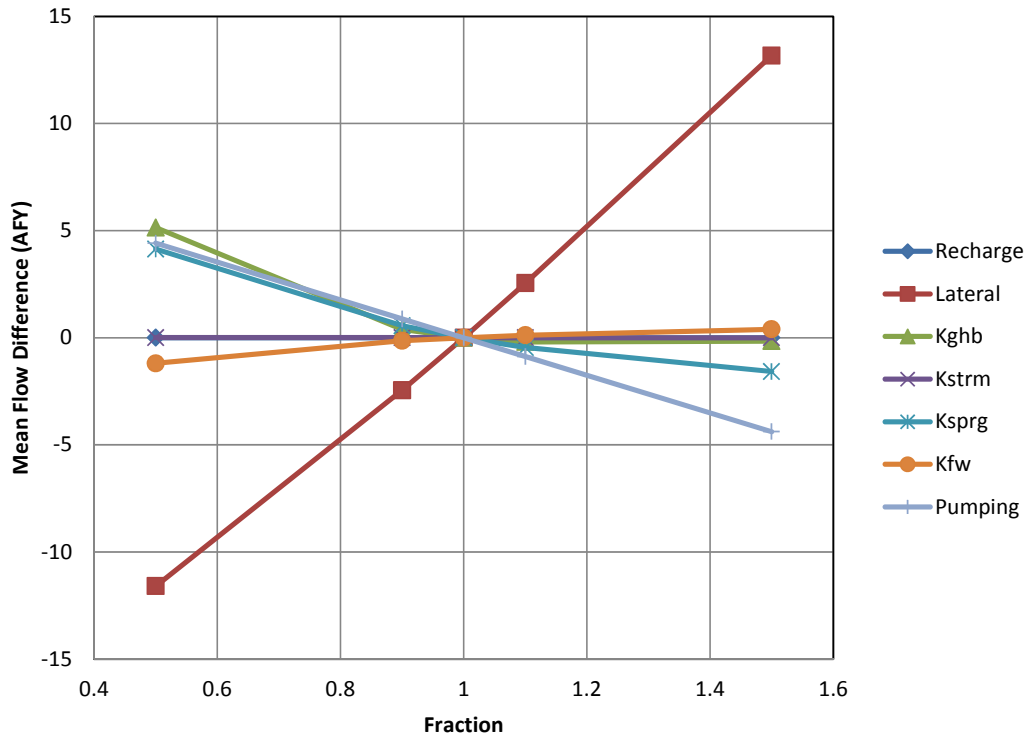

Figure 9.3.15 Transient sensitivity of flowing well flow in acre-feet per year to changes in boundary condition flows and conductances.

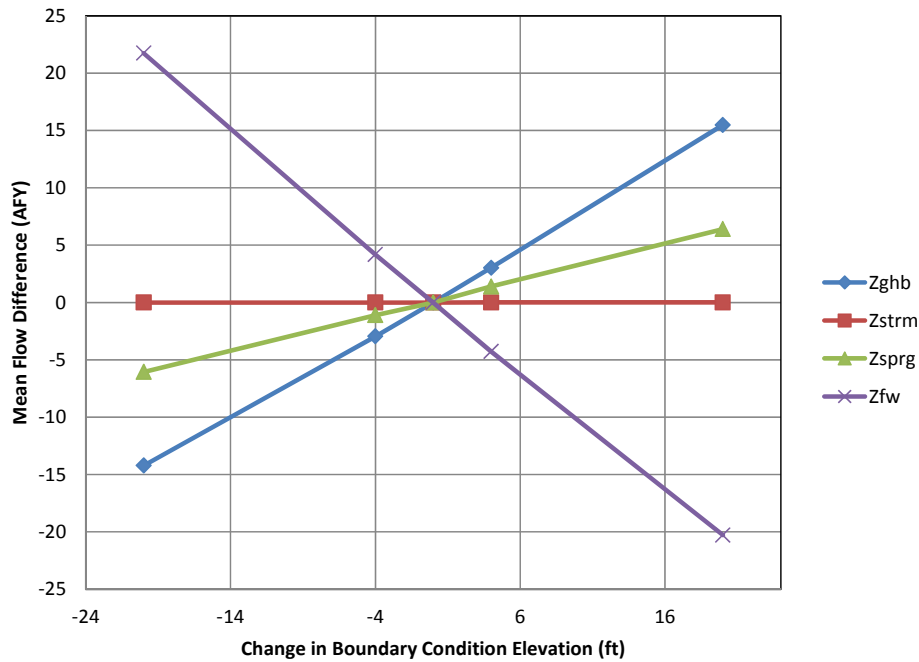

Figure 9.3.16 Transient sensitivity of flowing well flow in acre-feet per year to changes in boundary condition elevations.

Final Groundwater Availability Model for the Rustler Aquifer

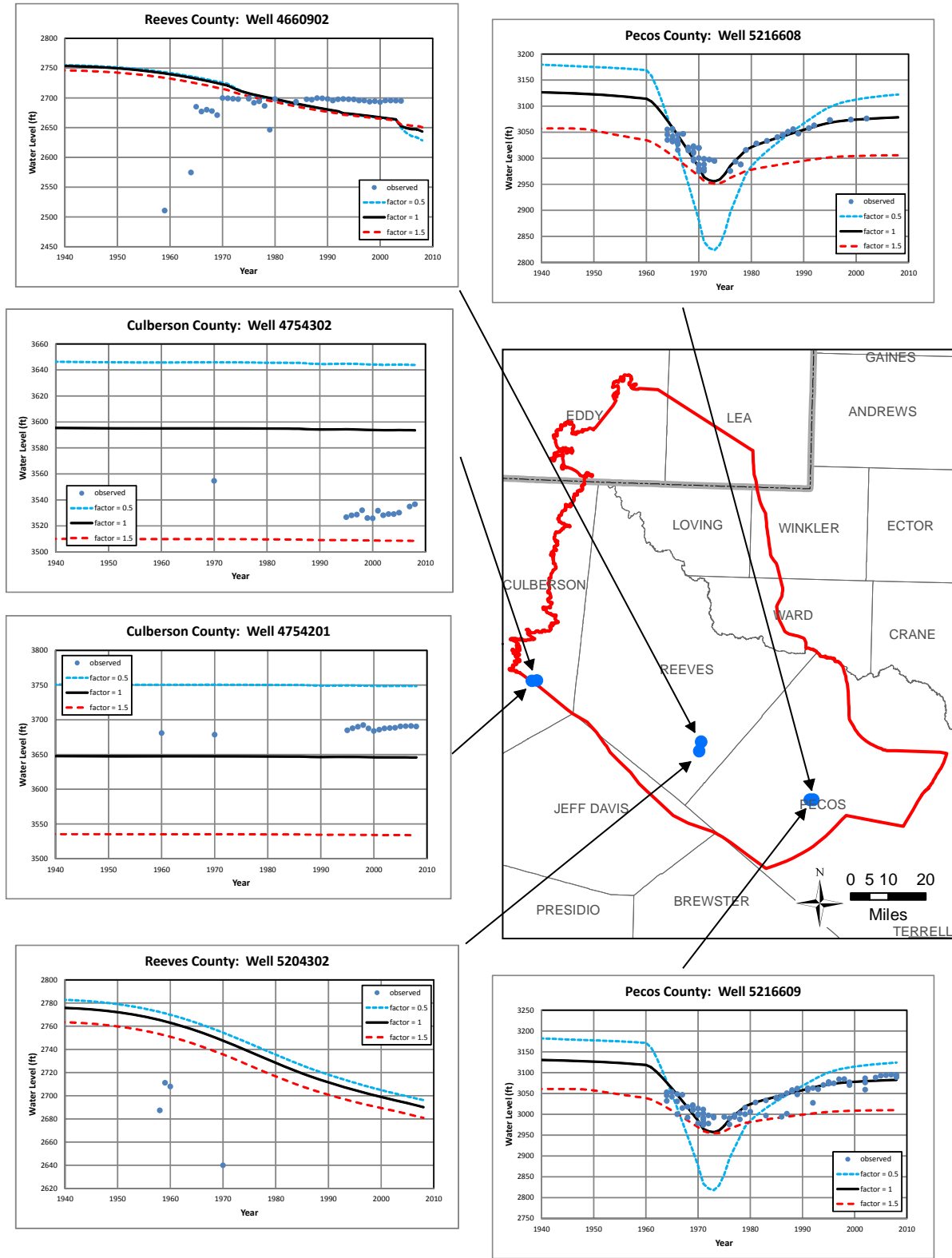

Figure 9.3.17 Transient sensitivity hydrographs of head in feet where the horizontal hydraulic conductivity of the Rustler Aquifer is varied.

Final Groundwater Availability Model for the Rustler Aquifer

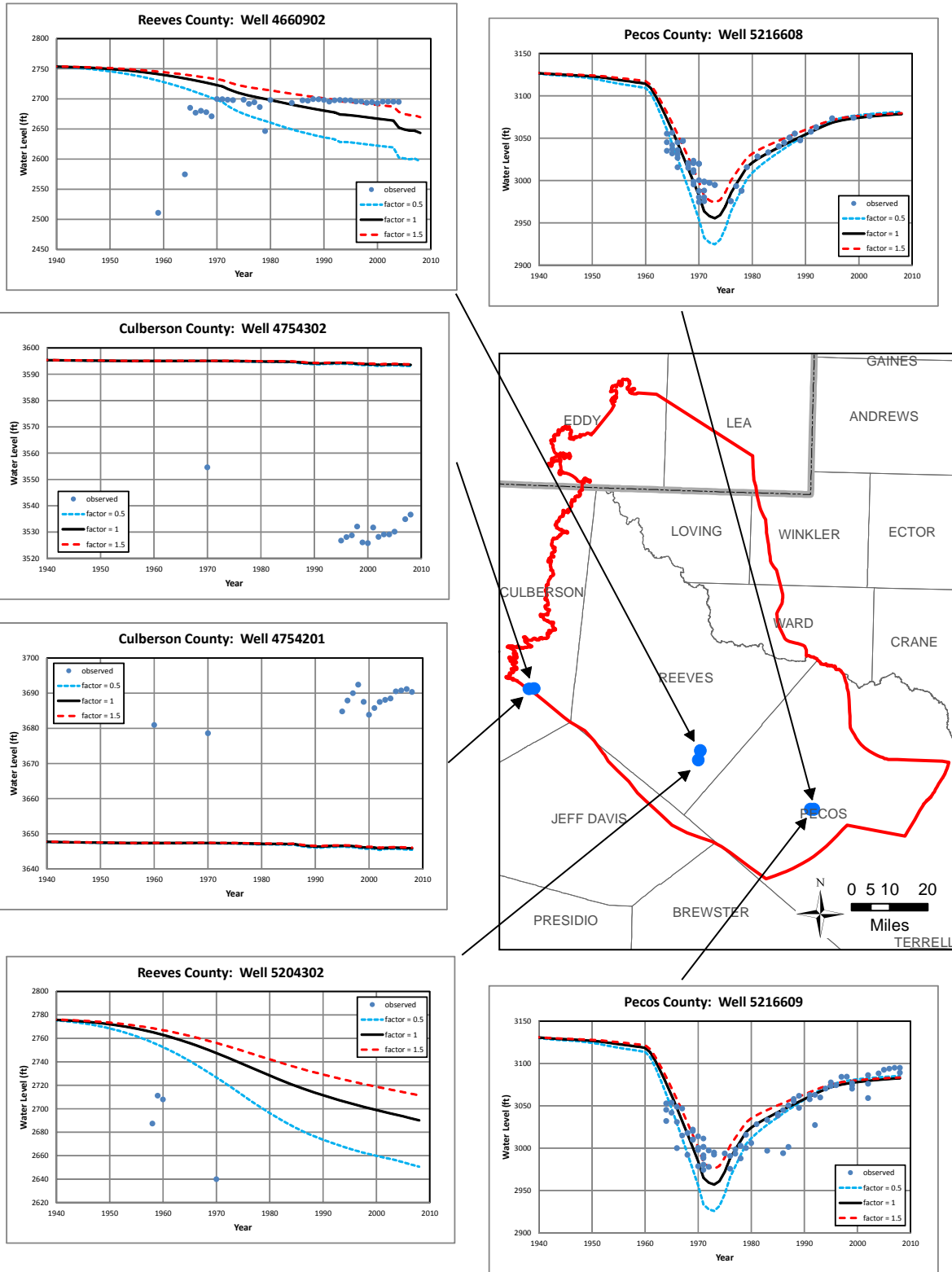

Figure 9.3.18 Transient sensitivity hydrographs of head in feet where the storage parameter is varied.

Final Groundwater Availability Model for the Rustler Aquifer

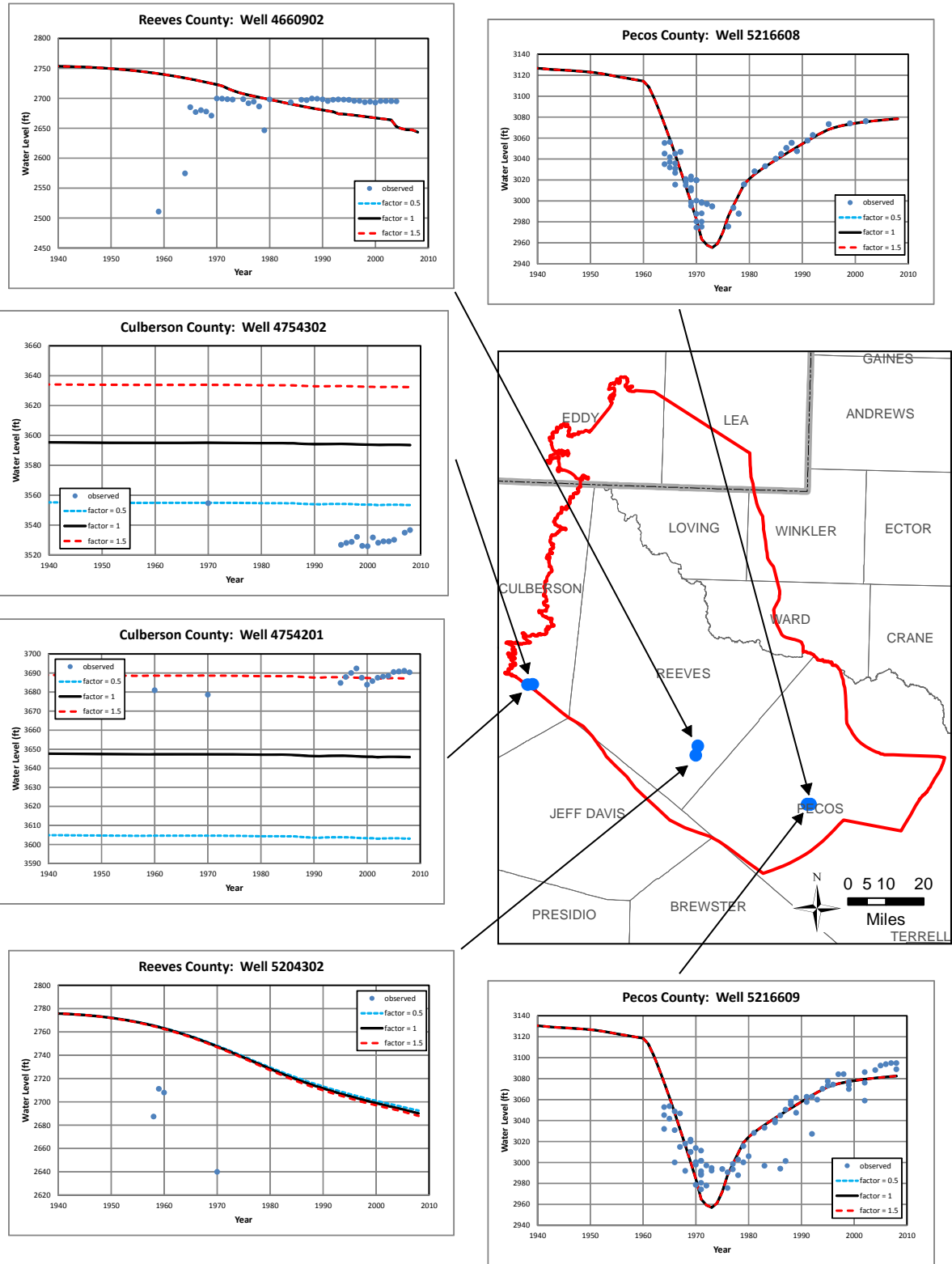

Figure 9.3.19 Transient sensitivity hydrographs of head in feet where recharge in the outcrop is varied.

Final Groundwater Availability Model for the Rustler Aquifer

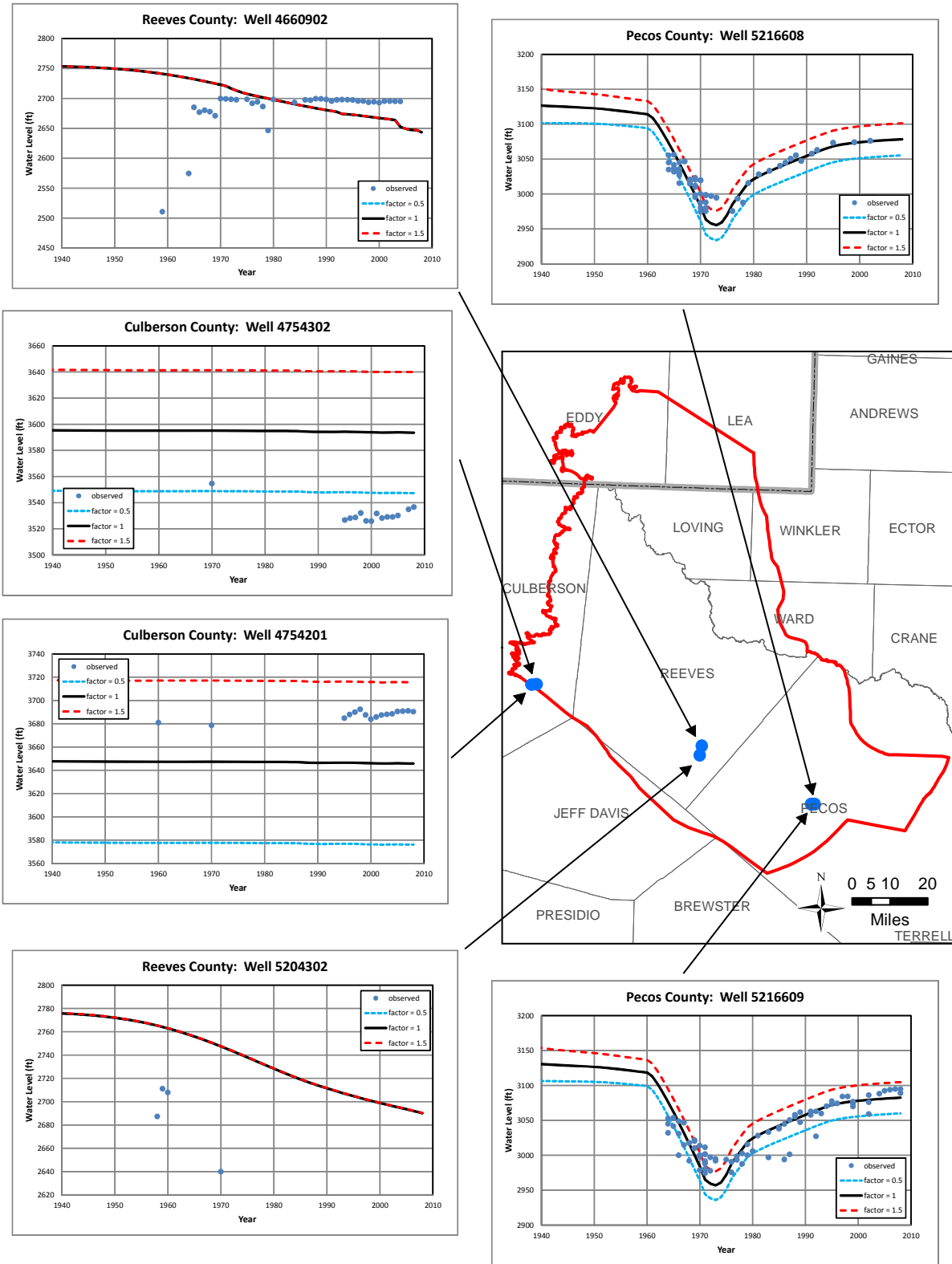

Figure 9.3.20 Transient sensitivity hydrographs of head in feet where the lateral inflow from the Glass and Davis mountains is varied.

Final Groundwater Availability Model for the Rustler Aquifer

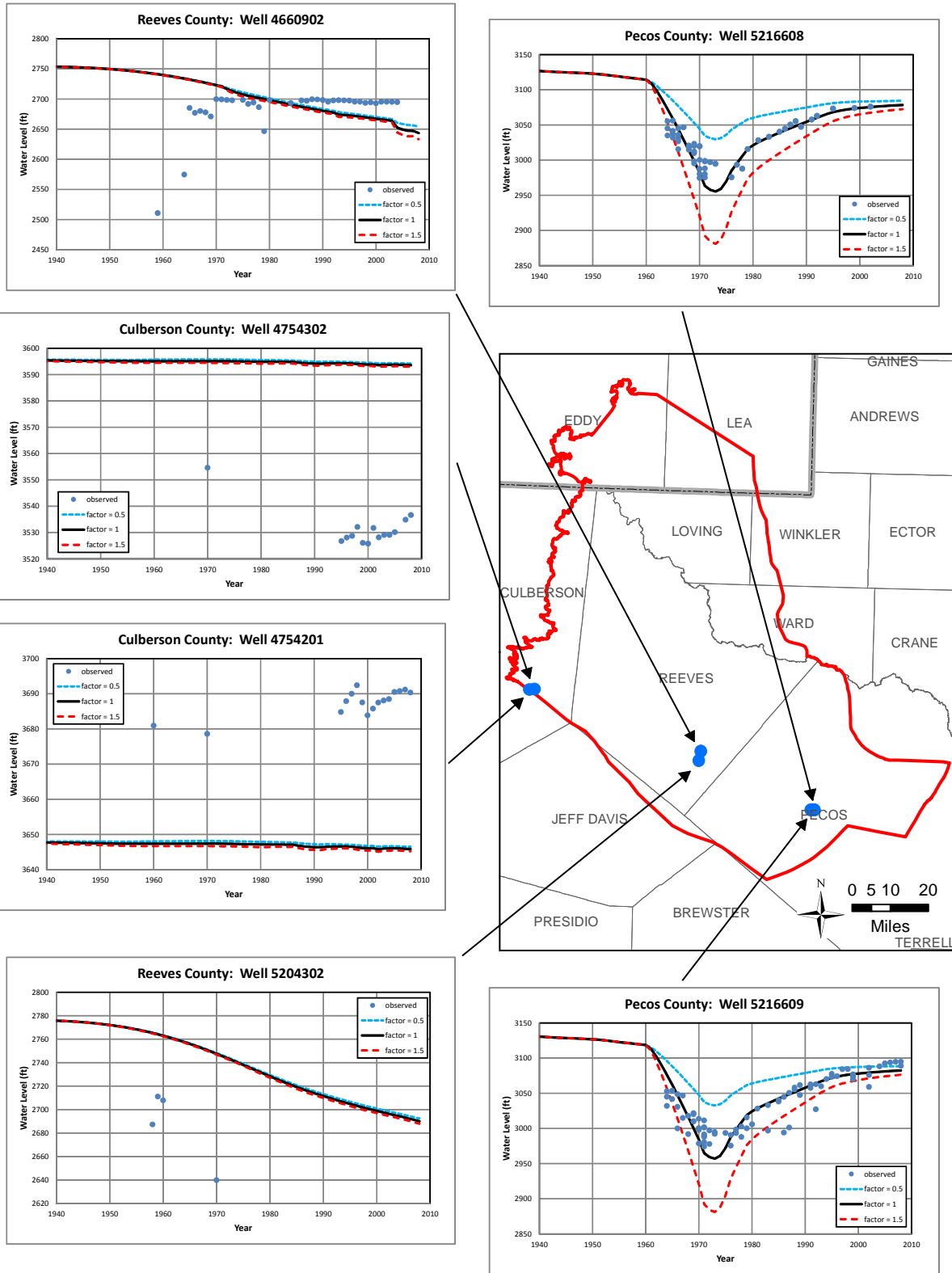

Figure 9.3.21 Transient sensitivity hydrographs of head in feet where pumping is varied.

Final Groundwater Availability Model for the Rustler Aquifer

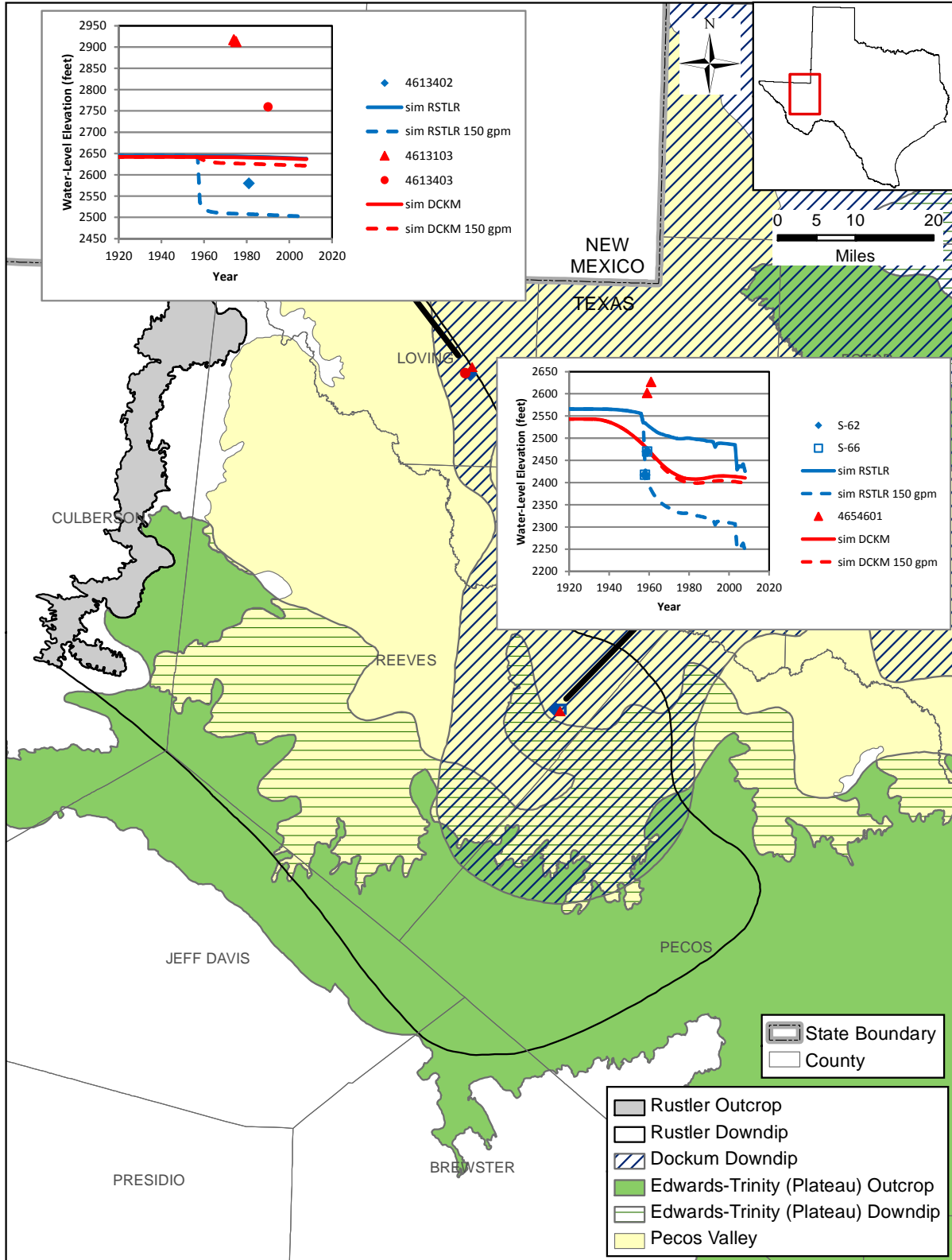

Figure 9.3.22 Sensitivity of vertical gradient to 600 acre-feet per year total pumping allocated equally at three wells.

Final Groundwater Availability Model for the Rustler Aquifer

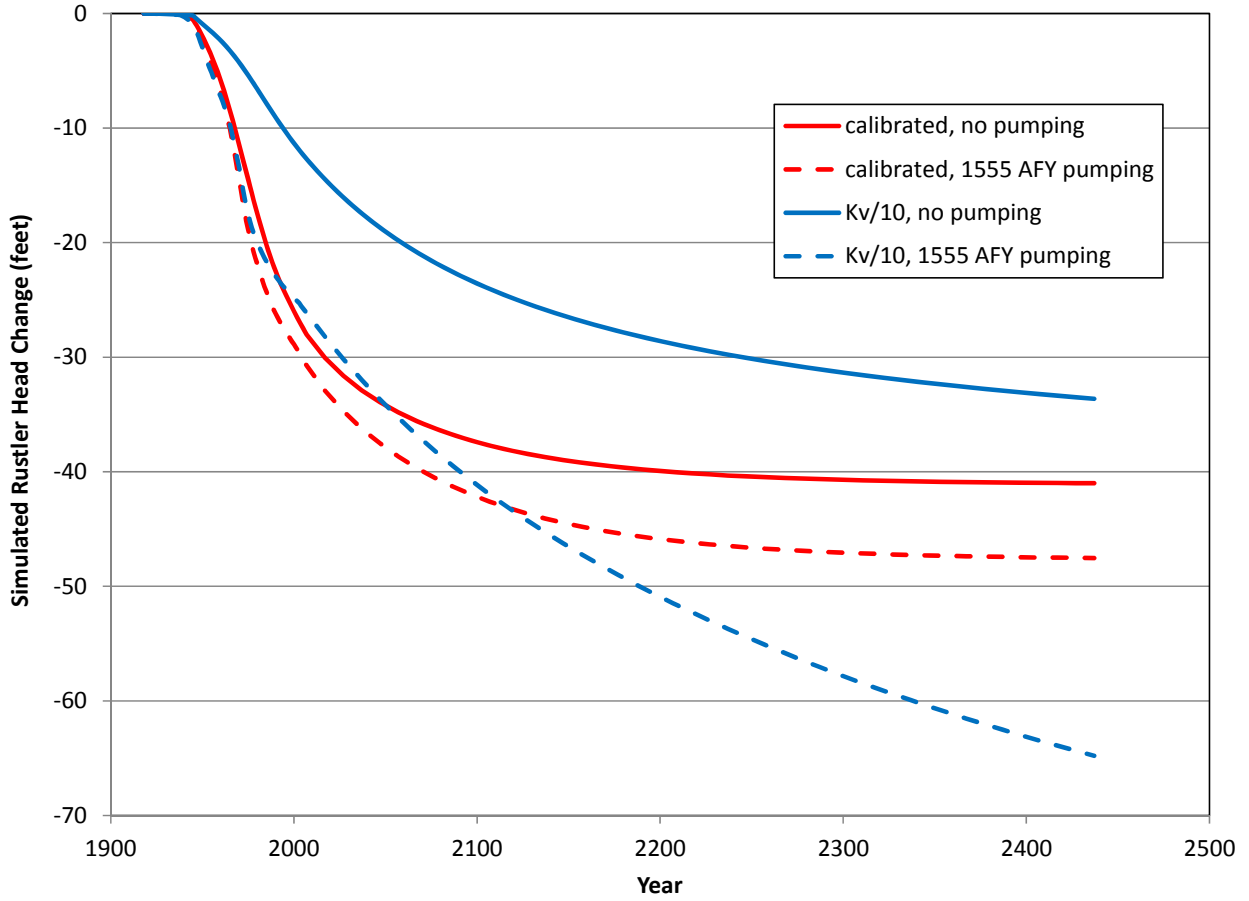

Figure 9.3.23 Long-term sensitivity to vertical hydraulic conductivity.

This page intentionally left blank.

10.0 Limitations of the Model

A model can be defined as a representation of reality that attempts to explain the behavior of some aspect of reality, but is always less complex than the real system it represents (Domenico, 1972). As a result, limitations are intrinsic to models. Model limitations can be grouped into several categories including: (1) limitations in the data supporting a model, (2) limitations in the implementation of a model, which may include assumptions inherent to the model application, and (3) limitations regarding model applicability. The limitations of this modeling study are discussed in the following paragraphs consistent with the categories listed above.

10.1 Limitations of Supporting Data

Developing the supporting database for a regional model with a large number of grid cells is a challenge. The primary limitations of the supporting database for the Rustler Aquifer groundwater availability model are:

- Limited hydraulic head targets both spatially and temporally,
- Limited frequency of water-level measurements to describe seasonal trends in the aquifer,
- Limited water-level measurements within the underlying Capitan Reef Complex Aquifer,
- High variability of the stream gain/loss estimates,
- Limited hydraulic property data over the active portion of the Rustler Aquifer,
- Limited data quantifying cross-formational flow between the underlying/overlying aquifers and the Rustler Aquifer,
- Limitations to data defining pumping from the Rustler Aquifer,
- Many wells are dual-completions into the Rustler and other aquifers limiting the utility of associated water-level measurements as calibration targets, and
- Uncertain structural data over many areas of the active model area under the Rustler Aquifer.

Each of these database limitations is discussed below.

The primary type of calibration target used in most models, including this groundwater availability model, is hydraulic head. In the parts of the Rustler Aquifer located in or near the

outcrop in Culberson County, in subdomain 7B in Reeves County, and in subdomain 4B in Pecos County sufficient head targets are available for both the steady-state and transient model calibrations. However, in the majority of the remainder of the Rustler Aquifer, there is a lack of available head data for both steady-state and transient conditions. Over the majority of the Rustler Aquifer, data were insufficient to assess the model's ability to match aquifer conditions. Both the steady-state and transient model calibrations could be improved with more available head targets to better constrain model calibration.

The temporal frequency of available water-level measurements was insufficient to identify any seasonal trends in Rustler Aquifer water levels. This lack of seasonal water-level data precludes calibrating the model to seasonal variations in hydrologic conditions.

Although the conceptual model indicates very little cross-formational flow between the Rustler Aquifer and the underlying strata over the vast majority of the model domain, some cross-formational flow likely occurs between the underlying Capitan Reef Complex Aquifer and the Rustler Aquifer in subdomains 4A and 4B (Armstrong and McMillion, 1961; Veni, 1991; Boghici, 1997). A lack of water-level data, structural data, and hydraulic property data for the Capitan Reef Complex Aquifer limits the ability to include this mechanism in the model. It was decided that the uncertainty involved in adding an underlying layer with general-head boundary conditions would be more detrimental to the model than the assumption that cross-formational flow from underlying formations is insignificant to the overall Rustler Aquifer water balance. This assumption is not without implications which are discussed in Section 10.2.

There are stream gain/loss estimates available for the Pecos River covering only a small portion of the model area. The estimates vary considerably between years and exhibit both gaining and losing conditions at different times. Lack of data with which to implement time-varying boundary conditions limits the ability to make a quantitative comparison between simulated and estimated gains/losses. The variability in the gain loss estimates is also very high making their direct applicability to this regional model suspect.

In the absence of measurements over the active model extent, horizontal hydraulic conductivity is based on inferred data from other portions of the Rustler Aquifer outside the active model domain and qualitative consideration of known productivity of wells in certain subdomains of

the aquifer. Estimates of the reduction in horizontal hydraulic conductivity with depth were based on measurements from the Culebra Dolomite Member of the Rustler Formation at the WIPP site in New Mexico and are assumed to be applicable as described in Section 6.4.1. Vertical hydraulic conductivity is difficult to estimate at the lateral scale of the Rustler Aquifer based on measurements and is better estimated through model calibration. Vertical conductivity was based simply on an anisotropy ratio in relation to the horizontal hydraulic conductivity. Ranges in specific storage were based on estimates from the Culebra Dolomite Member of the Rustler Aquifer at the WIPP site (see Section 6.4.3).

The Rustler Aquifer is a minor aquifer underlying several major aquifers. The Edwards-Trinity (Plateau) and Pecos Valley aquifers, which overly the majority of the Rustler Aquifer, have a water budget considerably larger than that of the Rustler Aquifer. Cross-formational flow from the Rustler Aquifer to the Edwards-Trinity (Plateau) and Pecos Valley aquifer is relatively inconsequential from the perspective of these overlying aquifers, however, from the perspective of the Rustler Aquifer, it can constitute a significant fraction of the Rustler Aquifer water budget. The percentage of the Rustler Aquifer that is confined makes cross-formational flow an important part of the aquifer water balance. Because this component of the flow balance is large and poorly constrained by measurements, this aspect of the model should be considered uncertain and could be considered a limitation to the model. The model does do a good job of matching cross-formational flow volumes that have been postulated in Pecos County by Boghici (1997).

There are areas in the Rustler Aquifer where measured drawdown data indicate the occurrence of pumping where there is no reported pumping. For example, two wells in Pecos County show significant drawdown and subsequent recovery but there is insufficient reported pumping in the county during the period of drawdown to support the observed water levels. An estimate was made of the pumping required to produce the observed water levels. However, this estimate is only constrained by a maximum value for permitted pumping from the Rustler Aquifer in the Belding area. Limitations in reported pumping can have a large impact in the ability of the model to represent hydrologic conditions in the aquifer. The calibrated pumping associated with the Belding area represents approximately 71 percent of the volume associated with available permits, which is assumed to be reasonable.

Completion interval data for the majority of the Rustler Aquifer wells is either not reported or indicates completions that include units outside of the Rustler Aquifer. This complicates the quantitative applicability of much of the head targets to direct comparison with the simulated heads at the well locations. These issues are exacerbated in the steady-state model by the fact that none of the head observations in the Rustler Aquifer predate development within the aquifer. The use of the maximum observed head in a given well is assumed to be the best available representation of the heads prior to development, but it is likely that many of these observations include drawdown as a result of aquifer development. This limits a quantitative comparison of simulated heads from the steady-state model to the observations. The calibration strategy dealt with this limitation by accepting a steady-state model that was biased high in its fit to the head targets.

The top of Rustler Formation log signatures are good across most of the study area. They differ to the far south, west, and southwest as erosion has removed some of the upper Rustler Formation or shallow subcrops are affected by dissolution and removal of more soluble sulfate beds. There are differences and difficulties with interpreting the Salado-Rustler contact to the southwest, south, and southeast. Two differing factors contribute to this difficulty. First is the fact, noted by many, that the lower Rustler Formation includes additional dolomite beds (e.g., Eager, 1984). These more commonly register as low gamma zones in the lower Rustler Formation. When they are within the more normal gamma “bulge,” they are relatively distinctive. Nevertheless, around the perimeter of the study area, Salado Formation halite has been removed, creating a residue that can be mistaken for lower Rustler Formation clastics. In addition, there appears to be a more clastic-rich zone in the upper Salado Formation in the south to southeastern part of the study area that may converge with the basal Rustler Formation and be included in a basal Rustler Formation interpretation. Because the focus of this study was on development of hydrostratigraphy, it was beyond the scope and budget of this project to fully resolve these issues. Instead, the best estimate of the Salado-Rustler contact was used. It may include some of the Salado Formation residue or siliciclastic zone and overestimate Rustler Formation thickness modestly. As a residue or siliciclastic zone may have similar hydraulic properties to lower Rustler Formation clastics, this may provide a better estimate of the “aquifer” than a stricter stratigraphic pick. Therefore, this limitation in supporting data is considered to be of minimal relative importance.

10.2 Assessment of Assumptions

There are several assumptions that are key to the model regarding construction, calibration, and, although not included in this modeling effort, prediction. These assumptions are related to the following aspects of the Rustler Aquifer GAM:

- Use of general-head boundaries to simulate overlying aquifers,
- Assumption of a no-flow boundary representing underlying aquifers,
- Lateral inflows from indirect recharge from mountains outside the model area, and
- Magnitude, spatial variation, and lack of temporal variation in direct recharge.

These are briefly discussed below along with the potential limitations of the assumption(s) used in developing the Rustler Aquifer model.

As discussed above, cross-formational flow is an important factor for the Rustler Aquifer because a large portion of the Rustler Aquifer underlies major aquifers. By simulating the overlying aquifers with a general-head boundary, it was assumed that flow from the Rustler Aquifer into the overlying aquifers is governed primarily by the hydraulic properties of the overlying confining units (Dewey Lake and Dockum formations) and the heads in the overlying aquifers (Edwards-Trinity (Plateau) and Pecos Valley aquifers). The heads in the overlying aquifers are based on a combination of observed water-level data and simulated heads from the Edwards-Trinity (Plateau) and Pecos Valley aquifers GAM. There is uncertainty in the head data for the overlying aquifers as well as in the simulated heads that were used to populate the general-head boundary heads in the model.

Perhaps an assumption of more importance is the treatment of the base of the Rustler Aquifer as a no-flow boundary. It is believed that there is significant potential for vertical cross-formational flow between the Capitan Reef Complex Aquifer and the Rustler Aquifer in hydrostructural subdomains 4A and 4B. Because the model implementation did not include a model layer below the Rustler Aquifer, this cross-formational flow would have to be simulated using a general-head boundary. An investigation related to implementing this boundary conducted during model calibration found that the parameters needed to define the boundary were uncertain and poorly defined and that the boundary could be very important to model behavior in hydrostructural subdomains 4A and 4B. Therefore, it was concluded that it would be better not to include a

general-head boundary on the base of the Rustler Aquifer because of inadequate constraint coupled with localized importance of that boundary. By adopting a no-flow boundary at the base of the Rustler Aquifer, both lateral inflow from the Glass Mountains and the horizontal hydraulic conductivity of hydrostructural subdomains 5 and 4B had to be increased. The calibrated lateral inflow rates are considered plausible and match upward cross-formational discharge measurements (Boghici, 1997), while the calibrated hydraulic conductivities are reasonable for a large-scale continuum model of a faulted/karstic aquifer system.

Direct recharge in the Rustler Aquifer outcrop comprises approximately 55 percent of the total aquifer inflow. The Glass Mountains, and to a lesser degree the Davis Mountains, have been conceptualized by multiple investigators to provide lateral sources of recharge to the Rustler Aquifer. Inflow from both of these areas at the active model boundaries was found to be necessary. These mechanisms of inflow to the aquifer are well founded by the available literature and by general concepts of hydrogeology. However, it is recognized that the lateral inflow rates are poorly defined, but considered reasonable based upon available data.

Recharge, either direct or indirect, is the primary source of inflow to the Rustler Aquifer. While average annual precipitation rates are well constrained, recharge is a small percentage of precipitation and is poorly constrained in magnitude. The lack of a method for correlating recharge to changes in precipitation results in the inability to specify temporal trends in recharge. Additionally, the spatial distribution of recharge is poorly constrained by data.

10.3 Limits for Model Applicability

The purpose of the TWDB GAM program is the development of models to determine the response of regional water levels to water resource development in an area smaller than a county and larger than a square mile. To accomplish these general objectives, a regional scale model with a constant grid-block size of one sixteenth of a square mile was developed. These two design criteria limit the spatial applicability of the Rustler Aquifer GAM. The accuracy of the model is likely representative at a scale of miles. Because of the model grid scale of one sixteenth of a square mile, the model is poorly suited for use in predicting aquifer responses at specific points, such as a selected well at a particular municipality, given the integration volume

Final Groundwater Availability Model for the Rustler Aquifer

of the model grid cells. The model is totally inappropriate for matching water-level responses within a well during pumping or recovery as this is a near point phenomenon.

The lack of data over short time periods for use in describing model boundary conditions means that stress periods of less than one year were not warranted. Use of annual stress periods precludes the ability of the model to predict seasonal head or flow variability.

The groundwater availability model provides a first-order approach to coupling surface water to groundwater, which is adequate for the stated purposes of the model. However, the model does not provide a rigorous solution to surface-water modeling.

The groundwater availability model does not simulate transport of solutes and cannot explicitly address water quality issues or how they may change under certain altered hydrologic regimes within the aquifer. An assessment of water quality is given in this report in Section 4.8.

This page intentionally left blank.

11.0 Future Improvements

To use models to predict future conditions requires a commitment to improve the model as new data become available or when modeling assumptions or implementation issues change. This groundwater availability model is no different. Through the modeling process, one generally learns what can be done to improve the model's performance or what data would help better constrain the model calibration. Future improvements to the model, beyond the scope of the current groundwater availability model, are discussed below.

11.1 Additional Supporting Data

Several types of data could be collected to better support future enhancement of the Rustler Aquifer GAM. These include additional water-level monitoring in areas of the Rustler Aquifer with sparse measurements, recharge studies, evaluation of pumping from the Rustler Aquifer, and additional study of the hydrogeology below the Rustler Aquifer, especially in the areas where the aquifer overlies the Capitan Reef Complex Aquifer. Because of the character of the Rustler Aquifer, a minor aquifer underlying major aquifers, any additional estimates quantifying cross-formational flow would help constrain the Rustler Aquifer water budget. Similarly, characterization of the degree of connection between the Rustler Aquifer and the Capitan Reef Complex Aquifer would further constrain the water budget in Pecos County. It would be valuable to increase water-level monitoring in areas of the Rustler Aquifer with future development potential, even if they are not currently extensively developed. If monitoring begins prior to increased development, the model can be calibrated against the pre-development response to improve model predictive capability in those regions.

Recharge is the primary method by which water enters the Rustler Aquifer. Improving the understanding of the magnitude and the spatial and seasonal distribution of recharge within the outcrop will enhance future models of the aquifer. Better constraints on the magnitude of lateral inflow of recharge emanating from the Glass and Davis mountains will also improve future models of the aquifer.

Although the rate of cross-formational flow between the Rustler Aquifer and the overlying aquifers is considered relatively small relative to overlying aquifer water budgets, it makes up a

large percentage of the Rustler Aquifer flow balance because a significant portion of the aquifer is confined. While limited qualitative information exists regarding cross-formational flow in the Rustler Aquifer, additional quantitative information regarding cross-formational flow would improve future models of the aquifer.

Further investigation of wells reportedly completed (depending on the data source) in either the Rustler Aquifer or the Rustler Aquifer and overlying and/or underlying units could be useful. Such an investigation could improve the Rustler Aquifer water-level targets either by removing ambiguous targets or by adding additional targets to locations within the aquifer that are currently poorly constrained by data.

In Pecos County, reported pumping for the Rustler Aquifer is inconsistent with water-level observations in wells. Water levels in two wells with good time-series data indicate drawdown due to pumping, but very little pumping is reported in Pecos County during the period of drawdown. For other counties, very few water-level measurements over time are available for use in evaluating water-level trends, making it difficult to discern the credibility of pumping estimates. This does not impact the model calibration, however, evaluation of future development in these portions of the aquifer may be compromised if the model implemented pumping differs from actual pumping. Future models of the Rustler Aquifer could be improved by eliminating the apparent inconsistencies with the pumping and reducing uncertainty in pumping.

11.2 Future Model Implementation Improvements

The Rustler Aquifer is situated in a very structurally and hydrogeologically complex region. From a review of Sections 4.1 and 4.2 of this report, it becomes obvious that the Rustler Aquifer is generally a poor aquifer over most areas of Texas and is both structurally and hydrogeologically isolated, depending upon the location within the aquifer. Interactions through cross-formational flow are known to be important and it is believed that the current model formulation does a good initial job of representing flow to younger formations and aquifers above the Rustler Aquifer. Although the inclusion of a lower Rustler Aquifer general-head boundary to account for cross-formational flow to and from underlying aquifers or units was investigated, the original assumption of a no-flow condition at the base of the Rustler Aquifer

was retained. The main reason for not including a lower boundary was the fact that it was unimportant over large areas of the model and, where it is important, there is a lack of data to properly formulate the boundary.

This discussion leads to the single-most important improvement that could be made to the Rustler Aquifer model, which is to include it with both the underlying and overlying aquifers in a single model. This would be far from trivial given the complex geologic structure of the Delaware Basin, but a model that integrates all the potential aquifers in the study area would offer better constraints to the flow balance, even with the current supporting data and hydrogeologic understanding of the basin.

A second model improvement that is likely important has to do with expanding the model boundaries to the north and east to areas that are currently not considered part of the Rustler Aquifer as defined by the TWDB. The reason that this may be important is because of the scarcity of groundwater resources in the region and the pressure being put on the water resources by the rapidly expanding oil and gas activity in the region. The Rustler Formation does extend to the east of the graben on to the Central Basin Platform.

11.3 Using the Model as a Predictive Tool

While developing a predictive model of the Rustler Aquifer is out of the scope of this groundwater availability model, an appreciation of the conceptual model and the available data provides for several recommendations that may be useful in the development of any future predictive model of the aquifer. The inflow rates used for the lateral boundary conditions and the stream stages and conductances used for the stream boundary conditions in the transient model for the historical period of the Rustler Aquifer represent long-term average values. These values are considered appropriate for use in any regional-scale applications of the Rustler Aquifer groundwater availability model in a predictive mode. The heads used for the general-head boundary conditions to represent the Edwards-Trinity (Plateau) and Pecos Valley Alluvium aquifers vary temporarily. Therefore, the heads used in the transient, historical model are inapplicable for use in a predictive model. In developing general-head boundary condition heads for a predictive model it is probably best to use predictive simulations of the Edwards-Trinity (Plateau) and Pecos Valley Alluvium aquifers. Two reasonable uses of the Edwards-Trinity

Final Groundwater Availability Model for the Rustler Aquifer

(Plateau) and Pecos Valley Alluvium aquifers predictive model are available. The simulated heads from the predictive model could be used directly to set the heads for the layer 1 general-head boundary condition. Alternately, the simulated drawdown from the predictive model could be used in conjunction with the late time general-head boundary heads from the transient model of the Rustler Aquifer.

12.0 Conclusions

This report documents a three-dimensional groundwater model developed for the Rustler Aquifer to the groundwater availability model standards defined by the TWDB. This regional-scale model was developed using MODFLOW. The Rustler Aquifer is modeled as one layer and the overlying Dewey Lake Formation and Dockum Aquifer are modeled as a combined hydrostratigraphic unit with a second (upper) layer. Interaction with younger aquifers overlying the Dewey Lake Formation and Dockum Aquifer are approximated through a general-head boundary condition.

The purpose of this groundwater availability model is to provide a calibrated numerical model of the Rustler Aquifer that can be used to assess regional groundwater availability and to assess the effects of water management strategies on the aquifer system. This groundwater availability model provides an integrated tool for the assessment of water management strategies to directly benefit state planners, Regional Water Planning Groups, Groundwater Conservation Districts, and Groundwater Management Areas.

The Rustler Aquifer GAM was developed using a modeling protocol that is standard to the groundwater model industry. This protocol includes; (1) the development of a conceptual model for groundwater flow in the aquifer, (2) model design, (3) model calibration, (4) sensitivity analysis, and (5) reporting.

This model, like all models, has limitations and can be improved. The groundwater availability model reproduced the steady-state and transient conditions of the aquifer within the TWDB calibration standards. More importantly, this calibrated groundwater availability model provides a documented, publicly-available tool for the assessment of future groundwater availability in the Rustler Aquifer.

The model was initially calibrated to steady-state conditions. The steady-state model does a good job of reproducing predevelopment water levels within the uncertainty of the head estimates. The average recharge rate estimated for the outcrop portions of the steady-state model area was 0.146 inches per year. In the steady-state calibration period, direct recharge in the outcrop and indirect recharge (lateral inflow) from the Glass and Davis mountains accounted for

approximately 55 and 45 percent of the net aquifer inflow, respectively, and upward cross-formational flow, springs, evapotranspiration, and baseflow to streams discharged approximately 66, 16, 14, and 4 percent of the net aquifer outflow, respectively. A sensitivity analysis was performed to determine which parameters had the most influence on aquifer performance and calibration. The most sensitive parameters for the steady-state model are the horizontal hydraulic conductivity of the Rustler Aquifer, the vertical hydraulic conductivity of the Rustler Aquifer, recharge in the outcrop, and the elevations of the general-head boundary heads in layer 1.

The model was also successfully calibrated to transient aquifer conditions from 1939 through 2008. The model satisfactorily reproduced aquifer heads during this time period. At the end of the transient model period, direct recharge in the outcrop, flow from storage, and indirect recharge (lateral flow from the Glass and Davis mountains) accounted for 36, 31, and 30 percent of the net aquifer inflow, respectively, and cross-formational flow, pumping, flowing wells, evapotranspiration, springs, and streams discharged approximately 54, 14, 12, 9, 5, and 2 percent of the net aquifer outflow, respectively. A sensitivity analysis was performed on the transient model. The most sensitive parameters for the transient model are the vertical hydraulic conductivity of the Rustler Aquifer, the horizontal hydraulic conductivity of the Rustler Aquifer, the conductance of the general-head boundaries in layer one, recharge, and the elevations of the general-head boundary heads in layer 1.

This Rustler Aquifer model was built to determine how regional water levels will respond to water resource development in an area smaller than a county and larger than a square mile. In addition, the model is useful in estimating consistent boundary conditions and hydraulic properties on a regional scale that could be applied to a refined model. Questions regarding local drawdown to a specific well should be based upon the analytical solution to the diffusion equation or a refined numerical model.

The Rustler Aquifer is in a structurally complex basin that has been demonstrated by this study to have compartmentalized the aquifer system to some degree. There are many areas within the active model domain where the Rustler Aquifer is completely off-set through faulting. Because of this complexity, there is a fair amount of uncertainty regarding lateral and cross-formational flow within the aquifer. Future revisions of the model could benefit from integrating the Rustler

Final Groundwater Availability Model for the Rustler Aquifer

Aquifer into the larger hydrogeologic framework directly in a larger multi-aquifer model. There is significant uncertainty regarding the quantitative relationship between the Capitan Reef Complex Aquifer and the Rustler Aquifer that may not be completely resolved in such a model formulation, but may be better constrained through the use of less boundary assumptions. These uncertainties aside, this model represents a large step forward in the understanding of the Rustler Aquifer in Texas and provides a very good foundation for future investigations.

Future uses of the groundwater availability model of the Rustler Aquifer will likely include predictive simulations. While development of a predictive model is beyond the scope of this groundwater availability model, recommendations for the application of the model in a predictive mode have been discussed in the context of future improvements to the model in Section 11.

This page intentionally left blank.

13.0 Acknowledgements

We would like to thank Mr. Paul Weatherby (General Manager) and Melissa Mills of the Pecos County Groundwater Conservation District for hosting our Stakeholder Advisory Forum. We would also like to thank Mr. Weatherby for providing the District's data on the Rustler Aquifer to us and for showing us the unnamed flowing well (Silbey well) located north of Ft. Stockton.

We would also like to thank the TWDB GAM staff led by Cindy Ridgeway for their support during this modeling study. We would like to thank Radu Boghici (former TWDB), Matt Uliana (sole proprietor), James Beach (LBG-Guyton), and Dr. Charles Kreitler (LBG-Guyton) for their insight and data to support our understanding of the Rustler Aquifer.

We would like to thank our senior technical reviewers for this project; Dr. John Sharp (University of Texas) and Dr. Robert Holt (University of Mississippi). Dr. Sharp provided timely counsel in interpreting a complex hydrogeologic environment and helped point out aspects of our draft conceptual model that were counter to the literature.

As always, we would like to thank Judy Ratto of INTERA for her efforts above and beyond the call of duty in developing this report.

This page intentionally left blank.

14.0 References

- Adams, J.E., 1944, Upper Permian Ochoan Series of Delaware Basin, west Texas and southeast New Mexico: Bulletin of the American Association of Petroleum Geologists, v. 28, p. 1596-1625.
- Alexander, R.B., Brakebill, J.W., Brew, R.E., and Smith R.A., 1999, ERFI--Enhanced river reach file 1.2: United States Geological Survey, Open-File Report 99-457.
- Anaya, R., and Jones, I., 2009, Groundwater availability model for the Edwards-Trinity (Plateau) and Pecos Valley aquifers of Texas: TWDB, Report 373.
- Anderson, M.P., and Woessner, W.W., 1992, Applied groundwater modeling: Academic Press, San Diego, California.
- Armstrong, C.A., and McMillion, L.G., 1961, Geology and ground-water resources of Pecos County, Texas, Volumes I and II: Texas Board of Water Engineers, Bulletin 6106.
- Ashworth, J.B., 1990, Evaluation of ground-water resources in parts of Loving, Pecos, Reeves, Ward, and Winkler counties, Texas: TWDB, Report 317.
- Bachman, G.O., 1981, Geology of Nash Draw, Eddy County, NM: United States Geological Survey, Open-File Report 81-31.
- Barker, R.A., and Ardis, A.F., 1992, Configuration of the base of the Edwards-Trinity Aquifer System and hydrogeology of the underlying pre-Cretaceous rocks, west-central Texas: United States Geological Survey, Water-Resources Investigations Report 91-4071.
- Barr, G.E., Miller, W.B., and Gonzalez, D.D., 1983, Interim report on the modeling of the regional hydraulics of the Rustler Formation: Sandia National Laboratories, SAND83-0391, Albuquerque, New Mexico.

- Beach, J.A., Ashworth, J.B., Finch, Jr., S.T., Chastain-Howley, A., Calhoun, K., Urbanczyk, K.M., Sharp, Jr., J.M., and Olson, J., 2004, Groundwater availability model for the Igneous and parts of the west Texas Bolsons (Wild Horse Flat, Michigan Flat, Ryan Flat and Lobo Flat) Aquifers: GAM report prepared for the TWDB.
- Beauheim, R.L., 1987, Interpretations of single-well hydraulic tests conducted at and near the Waste Isolation Pilot Plant (WIPP) site: Sandia National Laboratories, SAND87-0039, Albuquerque, New Mexico.
- Beauheim, R.L., 2002, Analysis package for interpretation of 1984 H-3 pumping tests: Sandia National Laboratories, ERMS#52203, WIPP Records Center, Albuquerque, New Mexico.
- Beauheim, R.L., 2011a, Rustler Formation transmissivity chart from WIPP Investigations: personal communication via email from Rick Beauheim, who led WIPP characterization studies with Sandia National Laboratories until recently, to Van Kelley, with INTERA, Incorporated, dated March 10, 2011.
- Beauheim, R.L., 2011b, Rustler Formation storage data from WIPP Investigations: personal communication via email from Rick Beauheim, who led WIPP characterization studies with Sandia National Laboratories until recently, to Van Kelley, with INTERA, Incorporated, dated March 19, 2011.
- Beauheim, R.L., and Ruskauff, G.J., 1998, Analysis of hydraulic tests of the Culebra and Magenta Dolomites and Dewey Lake rebeds conducted at the Waste Isolation Pilot Plant Site: Sandia National Laboratories, SAND98-0049, Albuquerque, New Mexico.
- Berger, D.L., Halford, K.J., Belcher, W.R., and Lico, M.S., 2008, Technical review of water-resources investigations of the Tule Desert, Lincoln County, southern Nevada: United States Geological Survey, Open-File Report 2008-1354.
- Boghici, R., 1997, Hydrogeological investigations at Diamond Y Springs and surrounding area, Pecos, County, Texas: The University of Texas at Austin, unpublished MA thesis.

Final Groundwater Availability Model for the Rustler Aquifer

- Boghici, R., and Van Broekhoven, N.G., 2001, Hydrogeology of the Rustler Aquifer, Trans-Pecos, Texas, in Mace, R.E., Mullican, III, W.F., and Angle, E.S., eds, Aquifers of west Texas: TWDB, Report 356.
- Borrelli, J., Fedler, C.B., and Gregory, J.M., 1998, Mean crop consumptive use and free-water evaporation for Texas: Report for TWDB Grant 95-483-137, February 1, 1998.
- Bowman, P., 2010, Water-level and water-quality data for United States Geological Survey wells in Eddy and Lea counties New Mexico: personal communication via email from Phillip Bowman, with the United States Geological Survey, New Mexico Water Science Center, to Toya Jones, with INTERA, Incorporated, dated March 18, 2010.
- Brown, E.M., 1998, Water quality in the Rustler Aquifer: TWDB, Hydrologic Atlas No. 9.
- Brown, J.B., Rogers, L.T., and Baker, B.B., 1965, Reconnaissance investigation of the ground-water resources of the middle Rio Grande Basin, Texas, in Davis, M.E., and Leggat, E.R., Reconnaissance investigations of the ground-water resources of the Rio Grande Basin, Texas: Texas Water Commission, Bulletin 6502.
- Brune, G., 2002, Springs of Texas, Volume I, Second Edition: Texas A&M University Press, College Station, Texas.
- Bumgarner, J.R., Stanton, G.P., Teeple, A.P., Thomas, J.V., Houston, N.A., Payne, J.D., and Musgrove, MaryLynn, 2012, A conceptual model of the hydrogeologic framework, geochemistry, and groundwater-flow system of the Edwards-Trinity and related aquifers in the Pecos County region, Texas: U.S. Geological Survey, Scientific Investigations Report 2012-5124.
- Bush, P.W., Ulery, R.L., and Rittmaster, R.L., 1994, Dissolved-solids concentration and hydrochemical facies in water of the Edwards-Trinity Aquifer System, west-central Texas: United States Geological Survey, Water-Resources Investigations Report 93-4126.
- Castro, M.C., and Goblet, P., 2003, Calibration of regional groundwater flow models: Working toward a better understanding of site-specific systems: Water Resources Research, v. 39, no. 6, p. SBH 13-1 - SBH 13-25.

- Chow, V.T., Maidment, D.R., and Mays, L.W., 1988, Applied hydrology: McGraw-Hill.
- Cooper, J.B., and Glanzman, V.M., 1971, Geohydrology of Project Gnome site, Eddy County, New Mexico: United States Geological Survey, Professional Paper 712-A.
- Cooper, H.H., and Jacob, C.E., 1946, A generalized graphical method for evaluating formation constants and summarizing well history: Transactions of the American Geophysical Union, v. 2, p. 526-534.
- Corbet, T.F., 2000, A groundwater-basin approach to conceptualize and simulate post-Pleistocene subsurface flow in a semi-arid region, southeastern New Mexico and western Texas, USA: Hydrogeology Journal, v. 8, p. 310-327.
- Corbet, T.F., and Wallace, M.G., 1993, Post-Pleistocene patterns of shallow groundwater flow in the Delaware Basin, southeastern New Mexico and west Texas, in Love, D. W., Hawley, J.W., Kues, B.S., Adams, J.W., Austin, G.S., and Barker, J.M., eds., New Mexico Geological Society Forty-fourth Annual Field Conference: New Mexico Geological Society, Carlsbad Region, New Mexico and west Texas, p. 321-325.
- Corbet, T.F., and Knupp, P.M., 1996, The role of regional groundwater flow in the hydrogeology of the Culebra Member of the Rustler Formation at the Waste Isolation Pilot Plant (WIPP), southeastern New Mexico: Sandia National Laboratories, SAND96-2133, Albuquerque, New Mexico.
- D'Appolonia Consulting Engineers, 1981, Modeling verification studies: Long-term waste isolation assessment, Waste Isolation Pilot Plant (WIPP) project, southeastern New, Mexico: consultant report prepared for Westinghouse Electric Corporation under contract to the United States Department of Energy.
- Davies, P.B, 1989, Variable-density ground-water flow and paleohydrology in the Waste Isolation Pilot Plant (WIPP) region, southeastern New Mexico: United States Geological Survey, Open-File Report 88-490.
- de Marsily, G., 1986, Quantitative hydrogeology, groundwater hydrology for engineers: Academic Press, Orlando, FL.

- Dockery, R.M., 1989, Origin of Shafter, Whalen, and Lazy X Ranch lake basins, Andrews County, Texas: Texas Tech University, MS thesis.
- Domenico, P.A., 1972. Concepts and models in groundwater hydrology: McGraw-Hill, New York.
- Eager, G.P., 1984, Core from the lower Dewey Lake, Rustler, and upper Salado Formation, Culberson County, Texas: Society for Sedimentary Geology, Permian Basin Section, Core Workshop No. 2, p. 273-283.
- Ewing, J.E., Jones, T.L., Yan, T., Vreugdenhil, A.M., Fryar, D.G., Pickens, J.F., Gordon, K., Nicot, J-P., Scanlon, B.R., Ashworth, J.B., and Beach, J., 2008. Groundwater availability model for the Dockum Aquifer: GAM report prepared for the TWDB.
- Freeze, R.A., 1969, The mechanism of natural ground-water recharge and discharge. 1. One-dimensional, vertical, unsteady, unsaturated flow above a recharging or discharging ground-water flow system: Water Resources Research, v. 5, no. 1, p. 153-171.
- Freeze, R.A., 1971, Three-dimensional, transient, saturated-unsaturated flow in a groundwater basin: Water Resources Research, v. 7, no. 2, p. 347-366.
- Freeze, R.A., 1975, A stochastic-conceptual analysis of one-dimensional ground-water flow in nonuniform homogeneous media: Water Resources Research, v. 11, no. 5, p. 679-694.
- Freeze, R.A., and Cherry, J.A., 1979, Groundwater: Prentice Hall, Englewood Cliffs, N.J., 604 p.
- Garza, S., and Wesselman, J.B., 1959, Geology and ground-water resources of Winkler County, Texas: Texas Board of Water Engineers, Bulletin 5916.
- Gates J.S., White, D.E., Stanley, W.D., and Ackermann, H.D., 1980, Availability of fresh and slightly saline groundwater in the basins of westernmost Texas: Texas Department of Water Resources, Report 256. (Also published as United States Geological Survey, Open-File Report 78-663).

- Gutjahr, A.L., Gelhar, L.W., Bakr, A.A., and MacMillan, J.R., 1978, Stochastic analysis of spatial variability in subsurface flows -2, Evaluation and application: Water Resources Research, v. 14, no. 5, p. 953-959.
- George, P.G., Mace, R.E., and Petrossian, R., 2011, Aquifers of Texas: TWDB, Report 380.
- Harbaugh, A.W., 2005, MODFLOW-2005, the U.S. Geological Survey modular ground-water model – the ground-water flow process: United States Geological Survey, Techniques and Methods 6-A16.
- Harbaugh, A.W., and McDonald, M.G., 1996, User's documentation for MODFLOW-96, An update to the U.S. Geological Survey modular finite-difference ground-water flow model: United States Geological Survey, Open-File Report 96-485.
- Harbaugh, A.W., Banta, E.R., Hill, M.C., and McDonald, M.G., 2000, MODFLOW-2000, The U.S. Geological Survey modular ground-water model - User guide to modularization concepts and the ground-water flow process: United States Geological Survey, Open-File Report 00-92.
- Harden, R.W., Beach, J.A., and Thornhill, M.R., 2011, Hydrogeologic, geochemical and groundwater modeling evaluation of the Leon-Belding area in Pecos County: Report prepared for Fort Stockton Holdings, L.P., Midland, Texas.
- Haug, A., Kelley, V.A., LaVenue, A.M., and Pickens, J.F., 1987, Modeling of ground-water flow in the Culebra Dolomite at the Waste Isolation Pilot Plant (WIPP) Site: Sandia National Laboratories, Interim Report, SAND86-7167, Albuquerque, New Mexico.
- Heitmuller, F.T., and Reece, B.D., 2003, Database of historical documented springs and spring flow measurements in Texas: United States Geological Survey, Open-File Report 03-315.
- Hentz, T.F., Price, J.G., and Gutierrez, N.G., 1989, Geologic occurrence and regional assessment of evaporate-hosted native sulfur, Trans-Pecos, Texas: The University of Texas at Austin, Bureau of Economic Geology, Report of Investigations No. 184.

Hill, C.A., 1996, Geology of the Delaware Basin, Guadalupe, Apache, and Glass Mountains, New Mexico and west Texas: Society for Sedimentary Geology, Permian Basin Section, Publication No. 96-39.

Hill, C.A., 1999, Reevaluation of the Hovey Channel in the Delaware Basin, west Texas: The American Association of Petroleum Geologists Bulletin, v. 83, no. 2, p. 277-294.

Hills, J.M., 1984, Sedimentation, tectonism, and hydrocarbon generation in Delaware Basin, west Texas and southeastern New Mexico: Bulletin of American Association of Petroleum Geologists, v. 68, p. 250-267.

Hiss, W.L., 1975, Stratigraphy and ground-water hydrology of the Capitan aquifer, southeastern New Mexico and western Texas: University of Colorado, unpublished Ph.D. dissertation, 396 p.

Hiss, W.L., 1976, Structure of the Permian Ochoan Rustler Formation, southwest New Mexico and west Texas: United States Geological Survey, Open File Report 76-54.

Holt, R.M., 1997, Conceptual model for transport processes in the Culebra Dolomite Member, Rustler Formation: Sandia National Laboratories, SAND97-0194, Albuquerque, New Mexico.

Holt, R.M., and Powers, D.W., 1984, Geotechnical activities in the waste handling shaft, Waste Isolation Pilot Plant (WIPP) project, southeastern New Mexico: United States Department of Energy, WTSD-TME 038, Carlsbad, New Mexico.

Holt, R.M., and Powers, D.W., 1986, Geotechnical activities in the exhaust shaft, Waste Isolation Pilot Plant: United States Department of Energy, DOE-WIPP 86-008, Carlsbad, New Mexico.

Holt, R.M., and Powers, D.W., 1988, Facies variability and post-depositional alteration within the Rustler Formation in the vicinity of the Waste Isolation Pilot Plant, southeastern New Mexico: United States Department of Energy, WIPP-DOE-88-004, Carlsbad, New Mexico,.

- Holt, R.M., and Powers, D.W., 1990a, Geotechnical activities in the air intake shaft (AIS): United States Department of Energy, DOE/WIPP 90-051, Carlsbad, New Mexico.
- Holt, R.M., and Powers, D.W., 1990b, Halite sequences within the late Permian Salado Formation in the vicinity of the Waste Isolation Pilot Plant, in Powers, D.W., Holt, R.M., Beauheim, R.L., and Rempe, N., eds., Geological and hydrological studies of evaporites in the northern Delaware Basin for the Waste Isolation Pilot Plant (WIPP): Geological Society of America, Dallas Geological Society, Guidebook 14, p. 45-78.
- Holt, R.M., and Powers, D.W., 2010, Evaluation of halite dissolution at a radioactive waste disposal site, Andrews County, Texas: Geological Society of America Bulletin, v. 122, p. 1989-2004.
- Holt, R.M., and Powers, D.W., 2011, Synsedimentary dissolution pipes and the isolation of ancient bacteria and cellulose: Geological Society of America Bulletin, published online February 22, 2011.
- Holt, R.M., Beauheim, R.L., and Powers, D.W., 2005, Predicting fractured zones in the Culebra Dolomite, in Faybishenko, B, Witherspoon, P.A., and Gale, J., eds., Dynamics of fluids and transport in fractured rock: American Geophysical Union, Geophysical Monograph Series, v. 162, p. 103-116.
- Hood, J.W., and Kister, L.R., 1962, Saline-water resources of New Mexico: United States Geological Survey, Water-Supply Paper 1601.
- Hood, J.W., and Knowles, D.B., 1952, Summary of ground-water development in the Pecos area, Reeves and Ward counties, Texas: Texas Board of Water Engineers, Bulletin 5202.
- Johnson, K.S., 1993, Dissolution of Permian Salado salt during Salado time in the Wink area, Winkler County, Texas, in Love, D. W., Hawley, J.W., Kues, B.S., Adams, J.W., Austin, G.S., and Barker, J.M., eds., New Mexico Geological Society Forty-fourth Annual Field Conference: New Mexico Geological Society, Carlsbad Region, New Mexico and west Texas, p. 211-218.

- Jones, I.C., 2001, Cenozoic Pecos Alluvium Aquifer, in Mace, R.E., Mullican, III, W.F., and Angle, E.S., eds., Aquifers of west Texas: TWDB, Report 356.
- Jones, I.C., 2004, Cenozoic Pecos Alluvium Aquifer, in Mace, R.E., Angle, E.S., and Mullican, W.F., III, eds., Aquifers of the Edwards Plateau: TWDB, Report 360.
- Jones, I.C., 2008, Investigating recharge in arid alluvial basin aquifers: The Pecos Valley Aquifer, Texas: Gulf Coast Association of Geological Societies Transactions, v. 58, p. 489-500.
- King, P.B., 1937, Geology of the Marathon region, Texas: United States Geological Survey, Professional Paper 187, 148 p.
- Knowles, D.B., and Lang, J.W., 1947, Preliminary report on the geology and ground-water resources of Reeves County, Texas: Texas Board of Water Engineers, Report M226.
- LaFave, J.I., 1987, Groundwater flow delineation in the Toyah Basin of Trans-Pecos Texas: The University of Texas at Austin, unpublished Master's Thesis, 159 p.
- Lang, W.B., 1935, Upper Permian formation of Delaware Basin of Texas and New Mexico: Bulletin of the American Association of Petroleum Geologists, v. 18, p. 262-270.
- Lang, W.B., 1937, The Permian formations of the Pecos Valley of New Mexico and Texas: Bulletin of the American Association of Petroleum Geologists, v. 21, p. 833-898.
- Larkin T.J., and Bomar, G.W., 1983, Climatic atlas of Texas: Texas Department of Water Resources, Report LP-192.
- LaVenue, A.M., Cauffman, T.L., and Pickens, J.F., 1990, Ground-water flow modeling of the Culebra Dolomite. Volume I: Model calibration: Sandia National Laboratories, SAND89-7068/1, Albuquerque, New Mexico.
- Leighty & Associates, Inc., 2001, Automated IFSAR terrain analysis system: United States army aviation & missile command, website
http://www.agc.army.mil/publications/ifsar/lafinal08_01/cover/cover_frame.htm.

Final Groundwater Availability Model for the Rustler Aquifer

- Lucas, S.G., and Anderson, O.J., 1994, Ochoan (late Permian) stratigraphy and chronology, southeastern New Mexico and west Texas, in Ahlen, J., Peterson, J., and Bowsher, A.L., Geologic activities in the 90s: New Mexico Bureau of Mines and Mineral Resources, Bulletin 150, p. 29-36.
- Mace, R.E., 2001, Estimating transmissivity using specific-capacity data: The University of Texas at Austin, Bureau of Economic Geology, Geological Circular 01-2.
- Maley, V.C., and Huffington, R.M., 1953, Cenozoic fill and evaporate solution in the Delaware Basin, Texas and New Mexico: Geological Society of America Bulletin, v. 64, p. 539-546.
- McDonald, M.G., and Harbaugh, A.W., 1988, A modular three-dimensional finite-difference ground-water flow model: United States Geological Survey, Techniques of Water-Resources Investigations, Book 6, Chapter A1.
- McGowen, J.H., Granata, G.E., and Seni, S.J., 1979, Depositional framework of the lower Dockum Group (Triassic) – Texas Panhandle: The University of Texas at Austin, Bureau of Economic Geology, Report of Investigations No. 97.
- Meigs, L.C., Beauheim, R.L., and Jones, T.L., eds., 2000, Interpretations of tracer tests performed in the Culebra Dolomite at the Waste Isolation Pilot Plant Site: Sandia National Laboratories, SAND97-3109, Albuquerque, New Mexico.
- Meyer, J., 2010a, Electronic geophysical logs: personal communication via hand delivery from John Meyer, with the TWDB, to Toya Jones, with INTERA, Incorporated, on October 19, 2010.
- Meyer, J., 2010b, TWDB_BRACS_StratPicks_12222010.xls spreadsheet containing stratigraphic picks: personal communication via email from John Meyer, with the TWDB, to Toya Jones, with INTERA, Incorporated, dated December 22, 2010.
- Middle Pecos Groundwater Conservation District, 2009, Application for historic and existing use for Belding Farms wells #24 and #26 completed into the Rustler Aquifer: personal communication via hand delivery from Paul Weatherby, manager of District, to Van Kelley, with INTERA, Incorporated, during the stakeholder meeting held on December 10, 2009.

- Myers, B.N., 1969, Compilation of results of aquifer tests in Texas: TWDB, Report 98.
- Narasimhan, B., Srinivasan, R., Quiring, S., Nielsen-Gammon, J.W., 2007, Digital climatic atlas of Texas: TWDB, Contract Report and Raster Dataset, GAM Resources website, <http://www.twdb.state.tx.us/gam/resources/resources.asp>, accessed 2010.
- National Climatic Data Center, 2001, Data and products, climate data inventories: website <http://www.ncdc.noaa.gov/oa/climate/climateinventories.html>, accessed 2001.
- Nielson, P.D., and Sharp, Jr., J.M., 1985, Tectonic controls on the hydrogeology of the Salt Basin, Trans-Pecos Texas. Pp. 231-235, in Dickerson, P.W., and Muehlberger, W.R., eds, Structure and tectonics of Trans-Pecos Texas: West Texas Geological Society Field Conference, Publication 85-81.
- Niswonger, R.G., Panday, S., and Ibaraki, M., 2011, MODFLOW-NWT, a Newton formulation for MODFLOW-2005: United States Geological Survey, Techniques and Methods 6-A37, 44 p.
- Nordstrom, P.L., and Quincy, R., 1999, Ground-water data system data dictionary: TWDB, UM-50.
- Ogilbee, W., Wesselman, J.B., and Irelan, B., 1962, Geology and ground-water resources of Reeves County, Texas, Volumes I and II: Texas Water Commission, Bulletin 6214.
- Oliver, W., 2010, Groundwater protection and/or water quality unit at the TWDB: personal communication via email from Wade Oliver, with the TWDB, to Toya Jones, with INTERA, Incorporated, dated March 26, 2010.
- Oregon State University, 2002, 2.5 arc-minute 1971-2000 mean annual precipitation grids for the conterminous United States: Oregon State University, Spatial Climate Analysis Service, Corvallis, Oregon.
- Parker, N.C., Allen, K., Arnold, K., Baker, R., Bradley, R., Cameron, G., Haskell, S., Holt, E., and Zimmerman, E., 2003, The Texas GAP analysis project: Final Report, 1135.

- Pickens, J.F., Dale, T.F., and Grisak, G.E., 2008, Hydrologic testing of borehole CP-975 at the Waste Control Specialists site, Andrews County, Texas: report to Waste Control Specialists LLC.
- Porch, Jr., E.L., 1917, The Rustler Springs sulphur deposits: University of Texas Bulletin 1722.
- Powers, D.W., 2010, Potential source of saline water at the base of Red Bluff Reservoir: personnel communication via telephone conversation between Dennis Powers, private consultant, and Toya Jones, with INTERA, Incorporated, on July 9, 2010.
- Powers, D.W., and Holt, R.M., 1999, The Los Medaños Member of the Permian Rustler Formation: *New Mexico Geology*, v. 21, no. 4, p. 97-103.
- Powers, D.W., and Holt, R.M., 2000, The salt that wasn't there: Mudflat facies equivalents to halite of the Permian Rustler Formation, southeastern New Mexico: *Journal of Sedimentary Research*, v. 70, no. 1, p. 29-36.
- Powers, D.W., Holt, R.M., Beauheim, R.L., and McKenna, S.A., 2003, Geological factors related to the transmissivity of the Culebra Dolomite Member, Permian Rustler Formation, Delaware Basin, southeastern New Mexico, in Johnson, K.S., and Neal, J.T., eds., *Evaporite karst and engineering/environmental problems in the United States: Oklahoma Geological Survey Circular 109*, p. 211-218.
- Powers, D.W., Holt, R.M., Beauheim, R.L., and Richardson, R.G., 2006, Advances in depositional models of the Permian Rustler Formation, southeastern New Mexico, in Land, L., Lueth, V.W., Raatz, W., Boston, P., and Love, D.W., eds., *Caves & karst of southeastern New Mexico: New Mexico Geological Society, Fall Field Conference, Guidebook 57*, p. 267-276.
- Prudic, D.E., 1988, Documentation of a computer program to simulate stream-aquifer relations using a modular, finite-difference, ground-water flow model: *United States Geological Survey, Open-File Report 88-729*.

- Red Bluff Water Power Control District, 2010, Daily lake elevations for Red Bluff Reservoir: personal communication via email from Robin Prewit, interim general manager for the Red Bluff Water Power Control District, to Toya Jones, with INTERA, Incorporated, dated November 29, 2010.
- Rees, R.W., 1987, Records of wells, water levels, pumpage, and chemical analyses from selected wells in parts of the Trans-Pecos Region, Texas 1968-1980: TWDB, Report 301.
- Rees, R., and Buckner, A.W., 1980, Occurrence and quality of ground water in the Edwards-Trinity (Plateau) Aquifer in the Trans-Pecos region of Texas: Texas Department of Water Resources, Report 255.
- Richardson, G.B., 1904, Report of a reconnaissance in Trans-Pecos Texas north of the Texas and Pacific Railway: University of Texas Bulletin 23.
- Richey, S.F., Wells, J.G., and Stephens, K.T., 1985, Geohydrology of the Delaware Basin and vicinity, Texas and New Mexico: United State Geological Survey, Water-Resources Investigations Report 84-4077.
- Ritchey, J.D., and Rumbaugh, J.O., eds., 1996, Subsurface fluid-flow (ground-water and vadose zone) modeling, ASTM STP 1288: American Society for Testing and Materials, West Conshohocken, PA., p. 61 - 80.
- Rumbaugh, J.O., and Rumbaugh, D.B., 2011, Guide to using Groundwater Vistas version 6: Environmental Simulations, Inc.
- Scanlon, B., Keese, K., Bonal, N., Deeds, N., Kelley, V., and Litvak, M., 2005, Evapotranspiration estimates with emphasis on groundwater evapotranspiration in Texas: report prepared for the TWDB.
- Schiel, K.A., 1988, The Dewey Lake Formation: End stage deposit of a peripheral foreland basin: The University of Texas at El Paso, unpublished MS thesis.

- Schiel, K.A., 1994, A new look at the age, depositional environment and paleogeographic setting of the Dewey Lake Formation (Late Permian?): West Texas Geological Society Bulletin, v. 33, no. 9, p. 5-13.
- Schuster, S.K., 1996, Water resource and planning assessment in San Solomon Springs and associated spring systems surrounding Balmorhea, Texas: The University of Texas at Austin, unpublished Master's Thesis, 102 p.
- Sharp, Jr., J.M., 1989, Regional ground-water systems in northern Trans-Pecos Texas, in Dickerson, P.W., and Muehlberger, W.R., eds., Structure and stratigraphy of Trans-Pecos Texas: American Geophysical Union, Field Trip Guidebook T317, p. 123-130.
- Sharp, Jr., J.M., 2001, Regional groundwater flow systems in Trans-Pecos Texas, in Mace, R.E., Mullican, III, W.F., and Angle, E.S., eds., Aquifers of west Texas: Texas Water TWDB, Report 356.
- Sharp, Jr., J.M., Boghici, R., and Uliana, M.M., 2003, Groundwater systems feeding the springs of west Texas, in Garrett, G.P., and Allan, N.L., eds. Aquatic fauna of the northern Chihuahuan Desert: Museum of Texas Tech University, Special Publications, Number 46.
- Slade, Jr., R.M., Bentley, J.T., and Michaud, D., 2002, Results of streamflow gain-loss studies in Texas, with emphasis on gains from and losses to major and minor aquifers, Texas, 2000: United States Geological Survey, Open-File Report 02-068.
- Small, T.A., and Ozuna, G.B., 1993, Ground-water conditions in Pecos County, Texas, 1987: United States Geological Survey, Water-Resources Investigations Report 92-4190.
- Stone, D.B., Moomaw, C.L., and Davis, A., 2001, Estimating recharge distribution by incorporating runoff from mountainous areas in an alluvial basin in the Great Basin region of the southwestern United States: Groundwater, v. 39, no. 6, p. 807-818.
- Tanji, K.K., 1990, Agricultural salinity assessment and management: American Society of Civil Engineers, Manuals and Reports on Engineering Practice No. 71.

Final Groundwater Availability Model for the Rustler Aquifer

Texas Parks and Wildlife, 2006, Plant guidance by ecoregions: website

<http://www.tpwd.state.tx.us/huntwild/wild/wildscapes/guidance/plants/ecoregions>.

Texas Parks and Wildlife, 2010, Red Bluff Reservoir: website

http://www.tpwd.state.tx.us/fishboat/fish/recreational/lakes/red_bluff/.

Texas Water Commission, 1989, Ground-water quality of Texas: Texas Water Commission, Report 89-01.

Thornhill Group, Inc., 2008, Edwards-Trinity Aquifer study: Leon-Belding area: Report prepared for Clayton Williams Farms, Inc.

TWDB, 1991, Surveys of irrigation in Texas – 1958, 1964, 1969, 1974, 1979, 1984, and 1989: TWDB, Report 329.

TWDB, 2006a, Maps & GIS data, GIS data, Major aquifers: website

<http://www.twdb.state.tx.us/mapping/gisdata.asp>.

TWDB, 2006b, Maps & GIS data, GIS data, Minor aquifers: website

<http://www.twdb.state.tx.us/mapping/gisdata.asp>.

TWDB, 2007a, Water for Texas – 2007: TWDB.

TWDB, 2007b, Maps & GIS data, GIS data, Groundwater Management Areas: website

<http://www.twdb.state.tx.us/mapping/gisdata.asp>.

TWDB, 2008, Maps & GIS data, GIS data, Regional Water Planning Areas: website

<http://www.twdb.state.tx.us/mapping/gisdata.asp>.

TWDB, 2009a, Evaporation/precipitation data for Texas: website

<http://midgewater.twdb.state.tx.us/Evaporation/evap.html>, accessed February 2009.

TWDB, 2009b, Census block shapefile: personal communication from Marius Jigmond at the TWDB to Tingting Yan at INTERA.

TWDB, 2010a, Maps & GIS data, GIS data, Groundwater Conservation Districts: website
<http://www.twdb.state.tx.us/mapping/gisdata.asp>.

TWDB, 2010b, Maps & GIS data, GIS data, Major river basins: website
<http://www.twdb.state.tx.us/mapping/gisdata.asp>, accessed February 2010.

TWDB, 2010c, Well information/groundwater data: website
http://www.twdb.state.tx.us/GwRD/waterwell/well_info.asp, accessed March 2010.

TWDB, 2010d, Water, information, integration & dissemination, water well data, wells in
TWDB groundwater database - Texas: website
http://wiid.twdb.state.tx.us/ims/wwm_drl/viewer.htm?, accessed April 2010.

TWDB, 2010e, Explanation of TWDB groundwater database (GWDB): website
<http://www.twdb.state.tx.us/GwRD/waterwell/groundwaterexplanation.htm>, accessed May
2010.

TWDB, 2012, Water for Texas 2012 State Water Plan: TWDB.

Uliana, M.M., 2000, Delineation of regional groundwater flow paths and their relation to
regional structural features in the Salt and Toyah Basins, Trans-Pecos Texas: The University
of Texas at Austin, unpublished Ph.D. dissertation, , 215 p.

Uliana, M.M., and Sharp, Jr., J.M., 2001, Tracing regional flow paths to major springs in Trans-
Pecos Texas using historical geochemical data: *Chemical Geology*, v. 179, issue 1-4,
p. 53-72.

United States Department of Energy, 1996, Title 40 CFR Part 191 compliance certification
application for the Waste Isolation Pilot Plant: United States Department of Energy,
DOE/CAO 1996-2184, Carlsbad Area Office.

United States Department of Energy, 2004, Title 40 CFR Part 191 compliance recertification
application for the Waste Isolation Pilot Plant: United States Department of Energy,
DOE/WIPP 04-3231, Carlsbad Area Office.

Final Groundwater Availability Model for the Rustler Aquifer

United States Department of Energy, 2009, Title 40 CFR Part 191 compliance recertification application for the Waste Isolation Pilot Plant: United States Department of Energy, DOE/WIPP 09-3424, Carlsbad Area Office.

United States Environmental Protection Agency, 2010, Primary distinguishing characteristics of level III ecoregions of the continental United States: website
http://www.epa.gov/wed/pages/ecoregions/na_eco.htm#Level III.

United States Environmental Protection Agency, 2011, Level II and IV ecoregions of the continental United States: website
http://www.epa.gov/wed/pages/ecoregions/level_iii_iv.htm, accessed March 2011.

United States Geological Survey, 2002, Physiographic divisions of the conterminous U.S.: website <http://water.usgs.gov/GIS/metadata/usgswrd/XML/physio.xml#stdorder>.

United States Geological Survey, 2010a, 30-m digital elevation model: United States Geological Survey, Seamless Data Warehouse website, <http://seamless.usgs.gov/>, accessed 2010

United States Geological Survey, 2010b, USGS surface-water data for the Nation: website <http://waterdata.usgs.gov/nwis/sw>, accessed 2010.

United States Geological Survey – Texas Water Science Center and the Texas Natural Resources Information System, 2004, Texas Digital Atlas of Texas: Texas Natural Resources Information System.

United States Salinity Laboratory, 1954, Diagnosis and improvement of saline and alkali soils: United States Department of Agriculture, Agricultural Handbook No. 60.

Veni, G., 1991, Delineation and preliminary hydrogeologic investigation of the Diamond Y Spring, Pecos County, Texas: George Veni & Associates, unpublished report, San Antonio, Texas.

Vine, J.D., 1963, Surface geology of the Nash Draw quadrangle, Eddy County, New Mexico: United States Geological Survey Bulletin 1141-B.

Final Groundwater Availability Model for the Rustler Aquifer

- Wahl, K.L., and Wahl, T.L., 1995, Determining the flow of Comal Springs at New Braunfels, Texas: Texas Water '95, American Society of Civil Engineers, August 16-17, 1995, San Antonio, Texas, p. 77-86.
- Warren, J.E., and Price, H.S., 1961, Flow in heterogeneous porous media: Society of Petroleum Engineers Journal 1, p. 153-169.
- Weiss, R., and Smith, L., 1998, Efficient and responsible use of prior information in inverse methods: Ground Water, v. 36, no. 1, p. 151-163.
- Wermund, 1996, Physiography of Texas: The University of Texas at Austin, Bureau of Economic Geology, website
<http://www.beg.utexas.edu/UTopia/images/pagesizemaps/physiography.pdf>.
- White, D.E., 1971, Water resources of Ward County, Texas: TWDB, Report 125.
- Wilson, J.L., and Guan, H., 2004, Mountain-block hydrology and mountain-front recharge, in Phillips, F.M., Hoga, J., and Scanlon, B., eds., Groundwater recharge in a desert environment: The southwestern United States: American Geophysical Union, October 2004.
- Winslow, A.G., and Kister, L.R., 1956, Saline-water resources of Texas: United States Geological Survey, Water-Supply Paper 1363.

APPENDIX A

Sensitivity Analyses by Hydrostructural Domain

Final Groundwater Availability Model for the Rustler Aquifer

This page intentionally left blank.

Final Groundwater Availability Model for the Rustler Aquifer

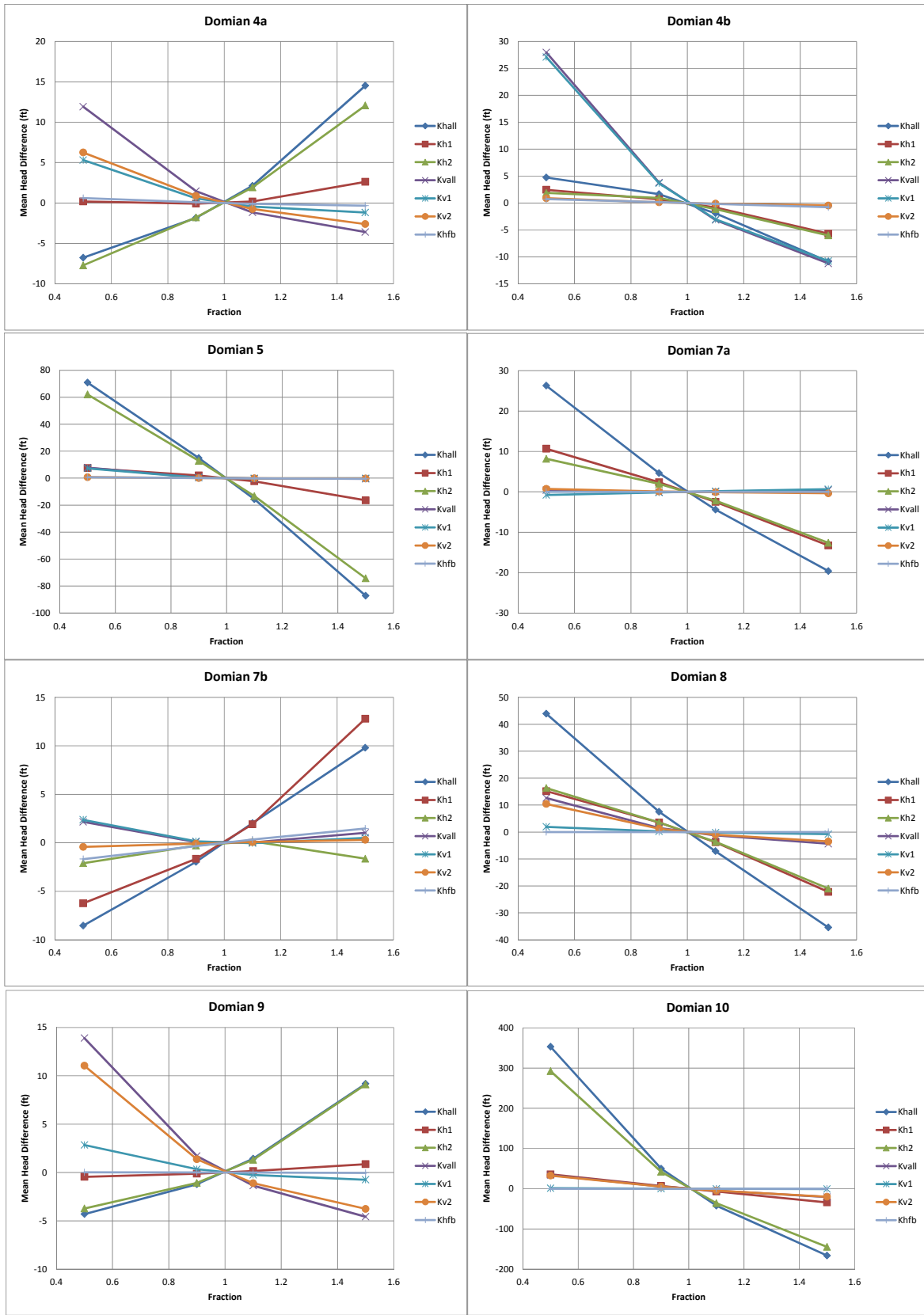

Figure A.1 Steady-state sensitivity of head to changes in hydraulic properties.

Final Groundwater Availability Model for the Rustler Aquifer

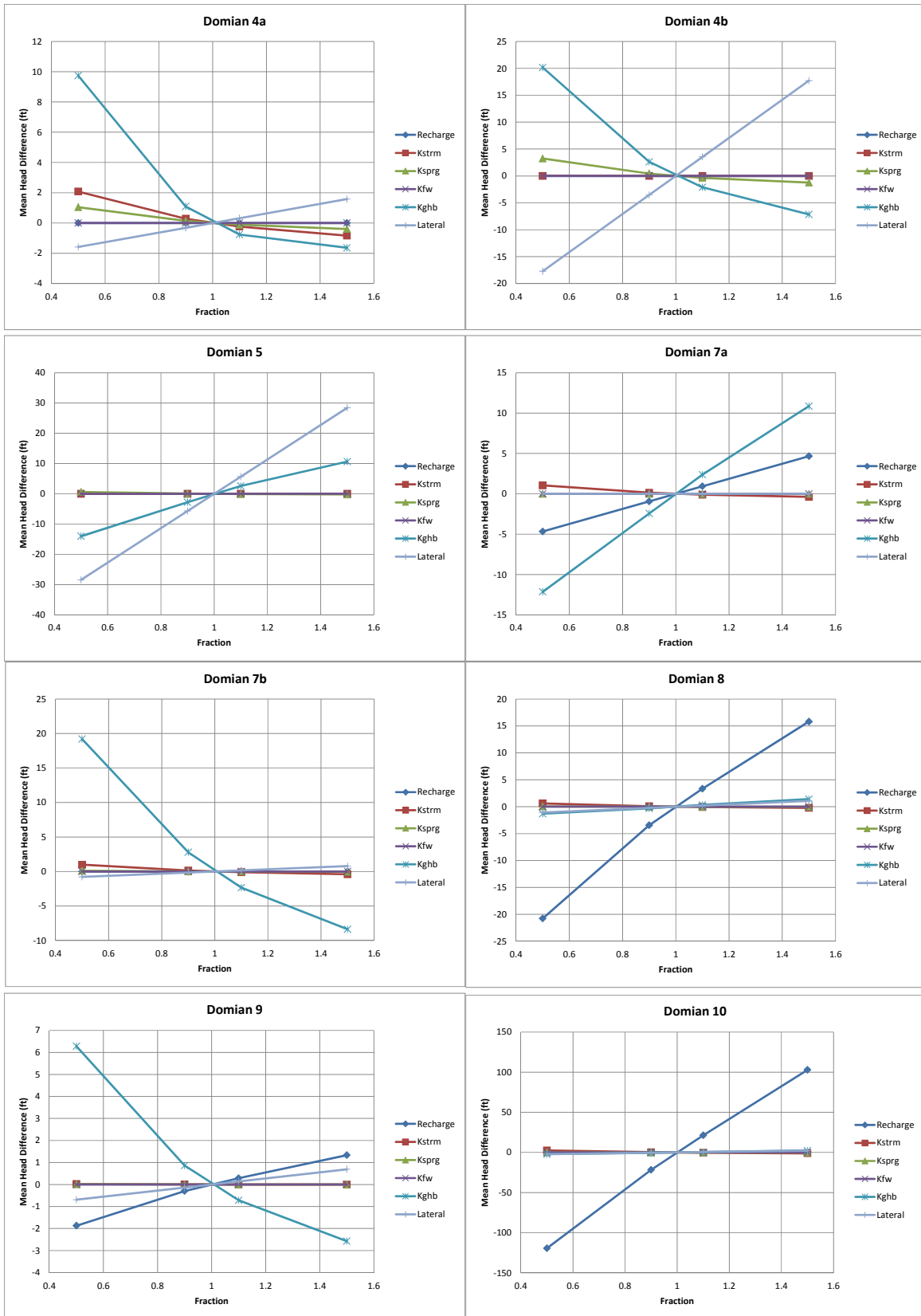

Figure A.2 Steady-state sensitivity of head to changes in boundary flows and conductances.

Final Groundwater Availability Model for the Rustler Aquifer

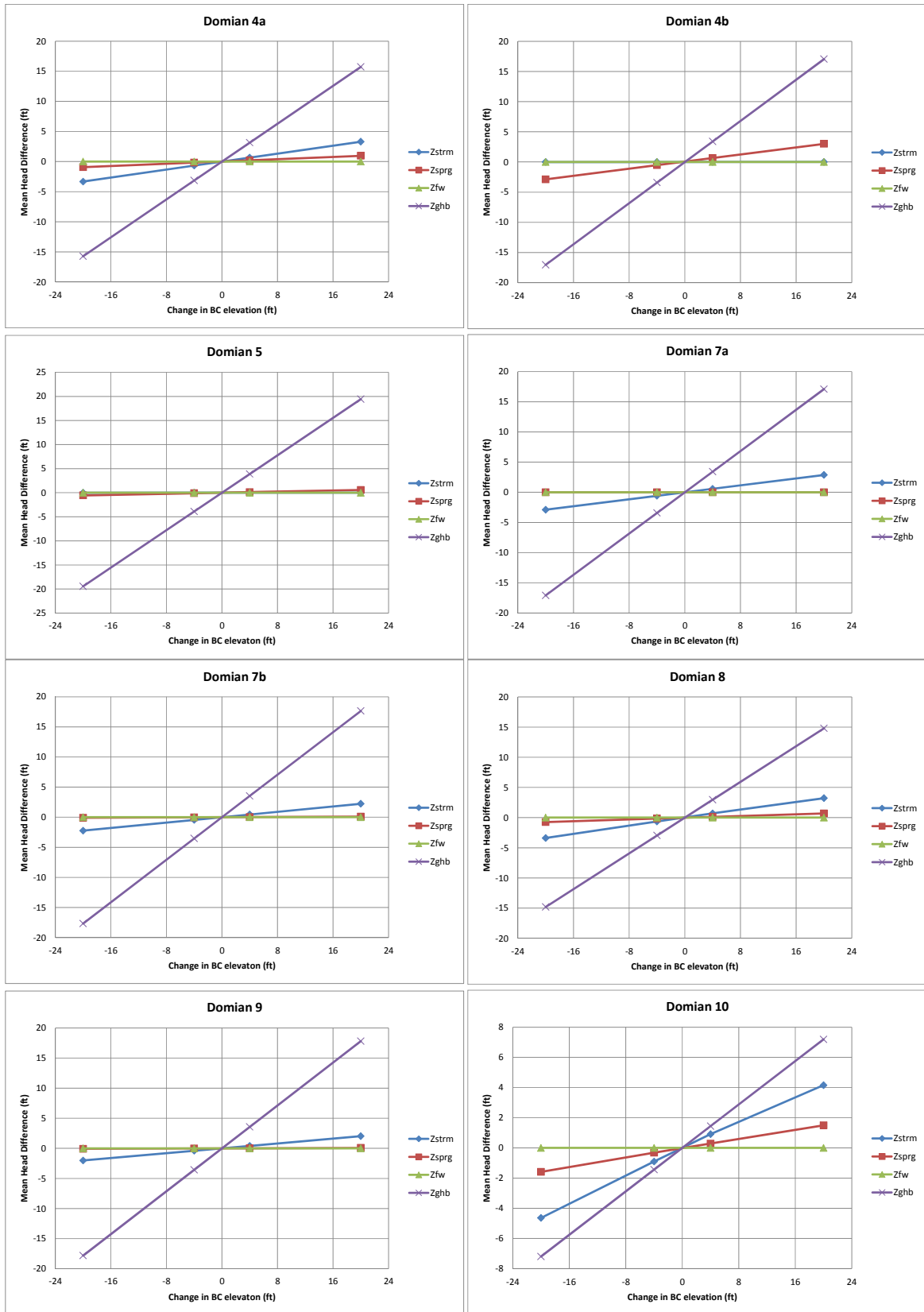

Figure A.3 Steady-state sensitivity of head to changes in boundary condition elevations.

Final Groundwater Availability Model for the Rustler Aquifer

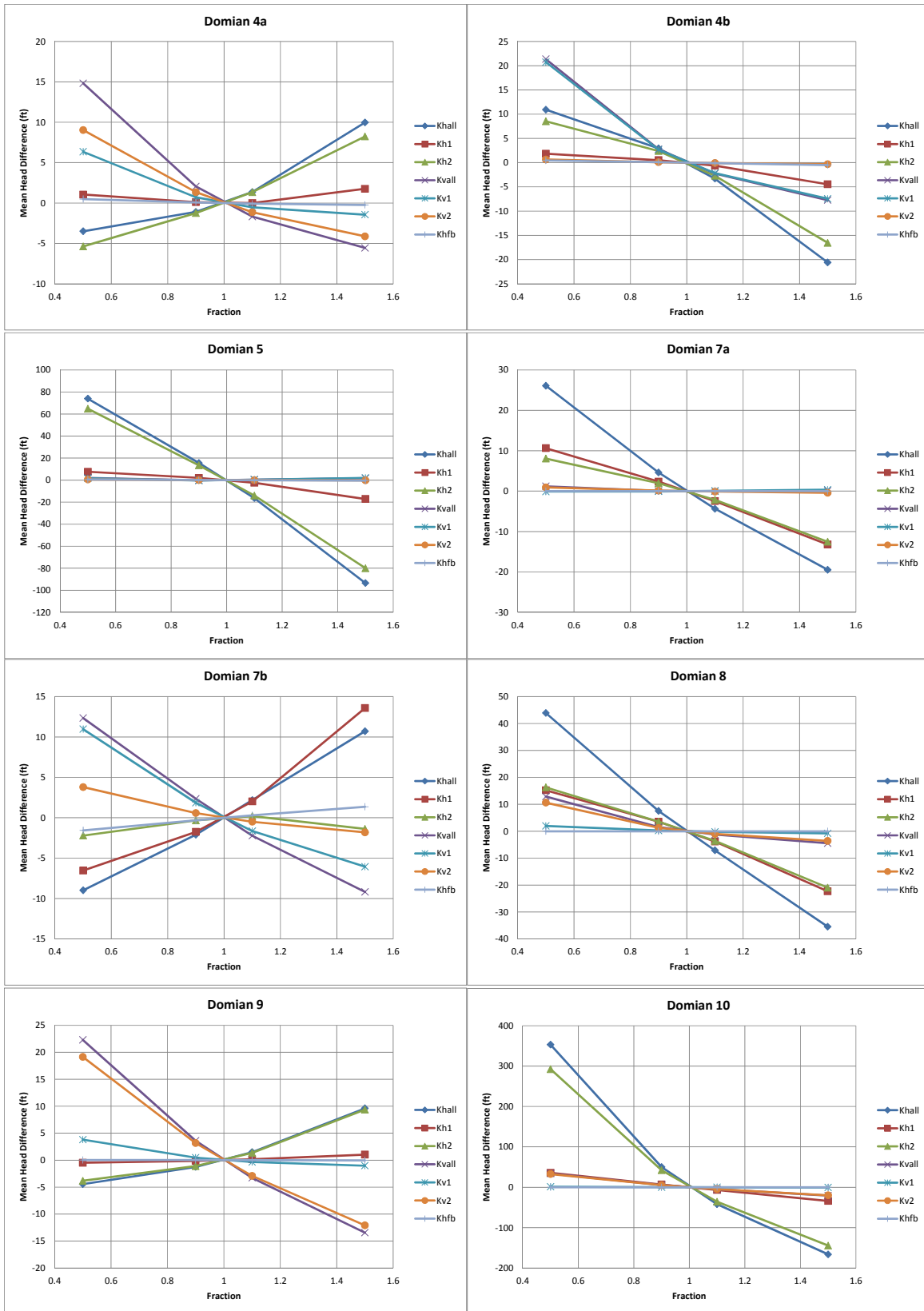

Figure A.4 Transient sensitivity of head to changes in hydraulic properties.

Final Groundwater Availability Model for the Rustler Aquifer

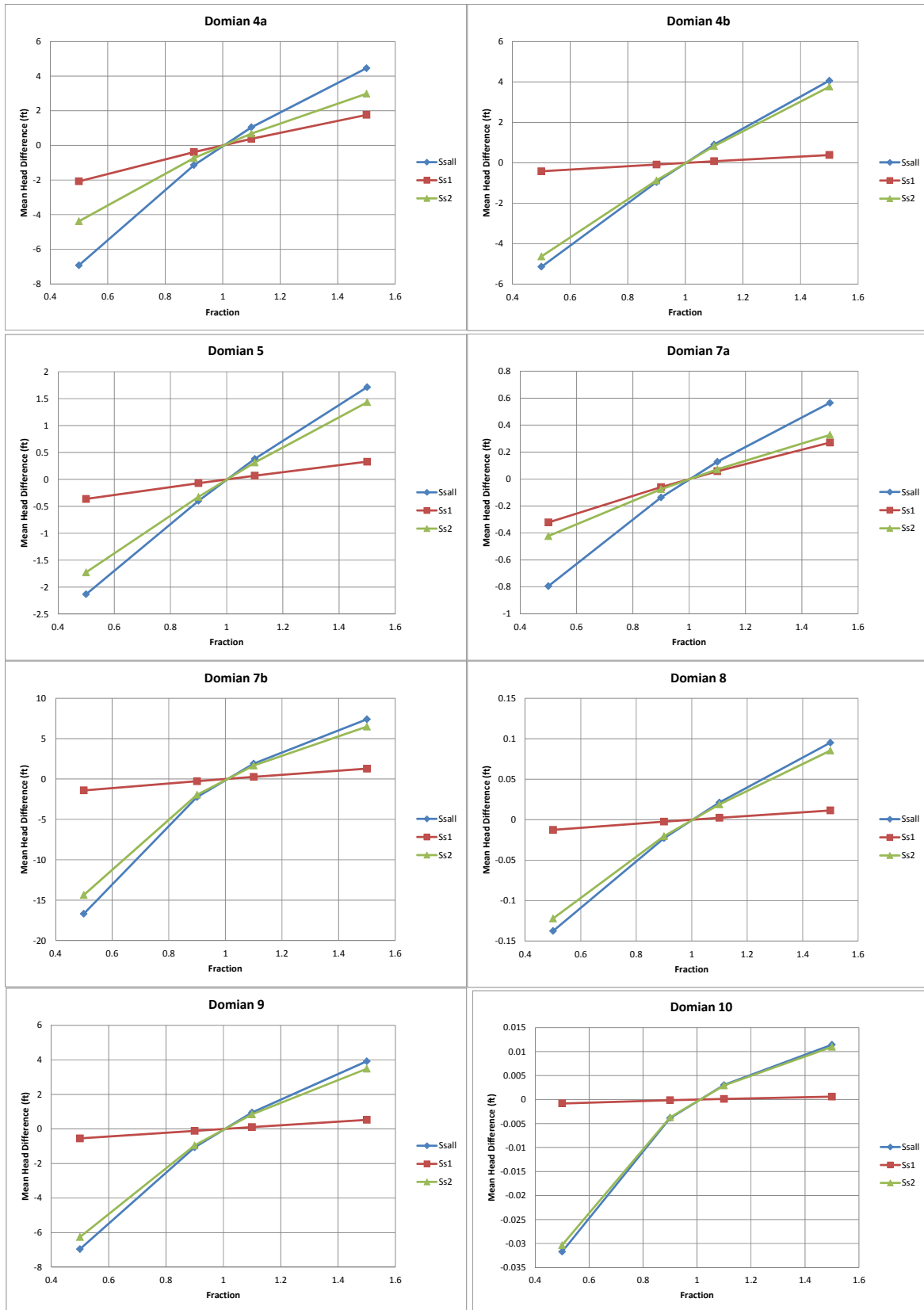

Figure A.5 Transient sensitivity of head to changes in storage parameters.

Final Groundwater Availability Model for the Rustler Aquifer

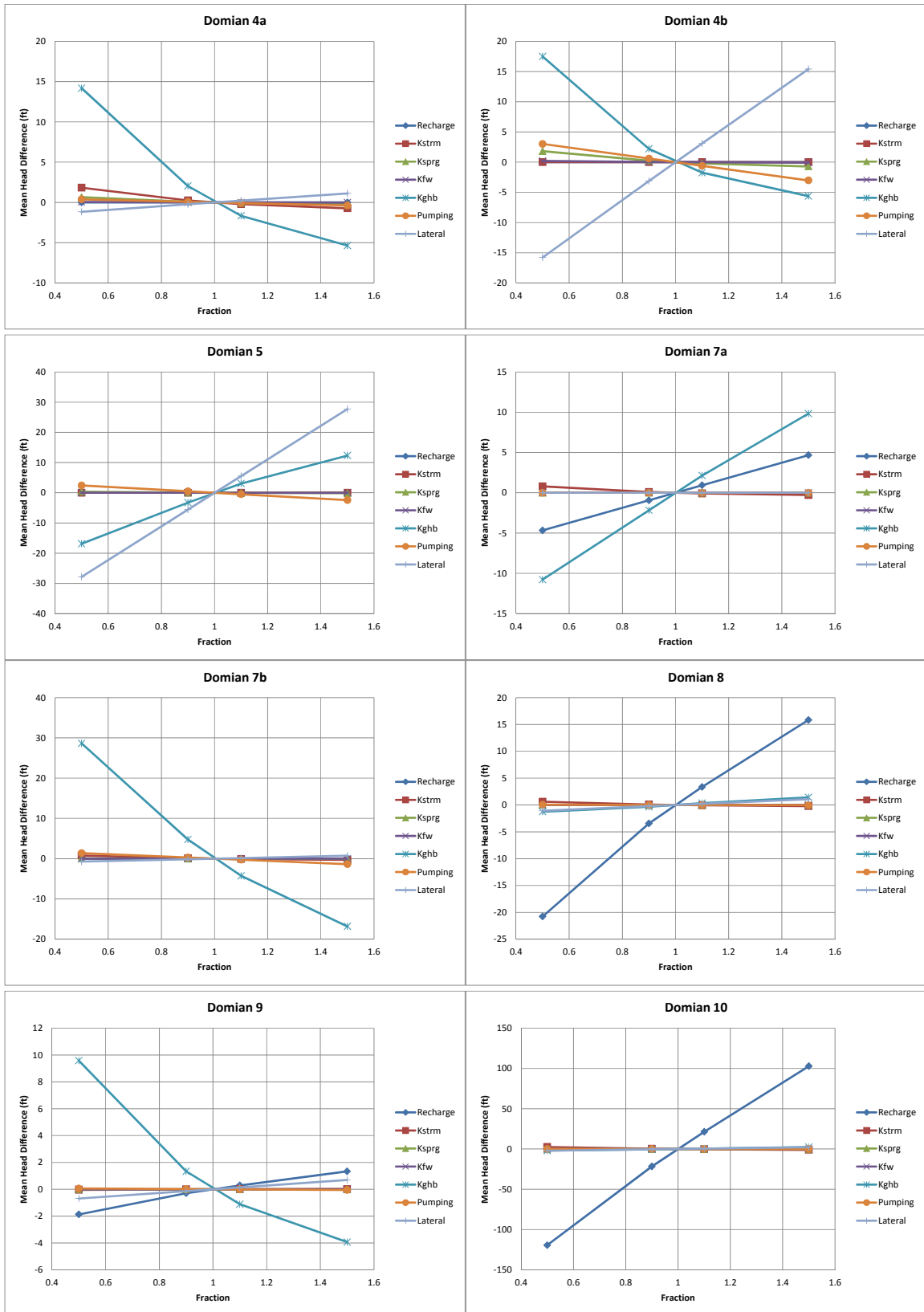

Figure A.6 Transient sensitivity of head to changes in boundary flows and conductances.

Final Groundwater Availability Model for the Rustler Aquifer

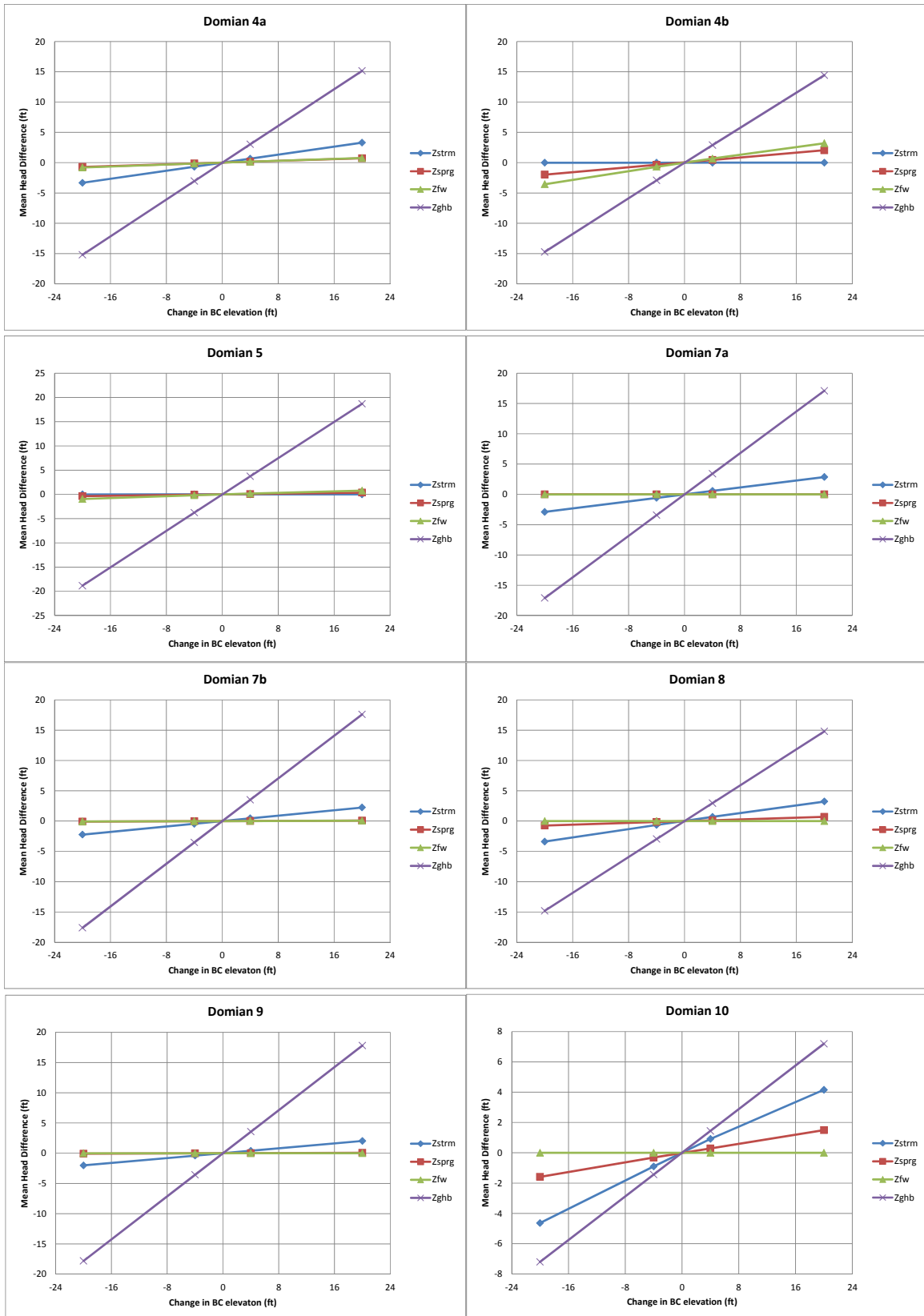

Figure A.7 Transient sensitivity of head to changes in boundary condition elevations.

This page intentionally left blank.

APPENDIX B

Conceptual Model Report Comments and Responses

Final Groundwater Availability Model for the Rustler Aquifer

This page intentionally left blank.

Appendix B

Comments on the March 2011 Draft Conceptual Model Report for the Rustler Aquifer Groundwater Availability Model

General Comments

The overall report is well written and comprehensive in its treatment of the various aspects of the groundwater flow system. It provides detailed explanations of each topic discussed and explores different approaches for addressing various conceptual modeling issues. After review of the report and meeting with INTERA staff about the conceptual model, TWDB staff have compiled several general and specific comments regarding the report, conceptual model, and approaches for developing groundwater availability model. The general comments are described here and the specific comments on the report text, figures, and geodatabase are included below.

Extension of the calibration period: Though water level data is generally sparse, several wells with multiple measurements show a sharp decline in water levels in the mid- to late-1960s followed by a recovery beginning around 1980. Because the period before 1980 shows large changes in the aquifer, TWDB staff recommends that the calibration period be extended back to include this period and forward to as close to the present as possible. As stated in Section 3.3 of the Scope of Work, the calibration period is negotiable and is not required to conform to the standard 1980 through 1997 period common to previous groundwater availability models. This is especially true since the highest estimated historical pumping does not correlate well with the large water level declines. We acknowledge that the pumping estimates developed by TWDB do not include "flowing wells" and contain significant uncertainty for the Rustler Aquifer.

Implementation of multiple conceptual models: Due to the complexity and uncertainty of the Rustler Aquifer flow systems described in the report, TWDB staff suggests implementing multiple conceptual models to evaluate the significance of different assumptions about the flow system. Possibilities for the multiple conceptualizations include no-flow versus general head lateral boundaries, how vertical flows (to/from both overlying and underlying units) are incorporated into the model, and the effect of different layering schemes. For example, the underlying Capitan Reef Complex Aquifer is discussed throughout the text as interacting with the Rustler Aquifer but is not included in the conceptual model. The base of the conceptual model shown in Figure 5.0.2 is a noflow boundary. Developing a model both including and excluding interaction with the underlying Capitan Reef Complex Aquifer may provide valuable insight into whether this component of flow is significant. TWDB encourages and will accept multiple "final" models of flow if they are found to be plausible through calibration.

Specific Comments

1. Throughout Report: There are several references to Jones (2001). Please refer to Jones (2004) - TWDB Report 360 and Jones (2008) - 2008 GCAGS Transactions for additional information that may be useful in developing the conceptual model.
Completed.
2. Throughout Report: Please change "Van Breokhoven" to "Van Broekhoven" wherever it appears in the text.
Completed.
3. Cover Page: Please use the updated TWDB logo. This file can be provided upon request.
Completed. See cover page.
4. Page 1-1, Paragraph 2: Please indicate that the Rustler formation also occurs in southern New Mexico.
Completed. See Section 1.0, paragraph 2.
5. Page 1-2, Paragraph 2, Line 4 and Figure 2.0.5 and throughout the report and figures: Please update references from the Edwards-Trinity Aquifer to the Edwards-Trinity (Plateau) Aquifer to distinguish it from the Edwards-Trinity (High Plains) Aquifer. In references concerning the geologic formation please find and replace references for Edward-Trinity to Edwards-Trinity.
Completed.
6. Page 1-2, Paragraph 3: Please remove last sentence.
Completed. See Section 1.0, paragraph 7.
7. Page 1-3, Paragraph 1, Line 2: Please reference the legislative session for House Bill 1763.
Completed. See Section 1.0, paragraph 9.
8. Page 2-1, Paragraph 1: Please add a statement in the text that the spatial extent of the Rustler Aquifer has been extended beyond the official TWDB boundaries into New Mexico.
Completed. See Section 2.0, paragraph 1.
9. Page 2-1, Paragraph 4, Line 6: Please change to specify that the Rustler Aquifer does not exist within the boundaries of any river authority.
Completed. See Section 2.0, paragraph 4.
10. Page 2-1, Paragraph 5: Please move the first sentence to the previous paragraph.
Completed. See Section 2.0, paragraph 4.
11. Page 2-13, Paragraph 3: Please provide a source for the topographic map shown in Figure 2.1.3.
Completed. See Section 2.1, paragraph 3 and Figure 2.1.3.

12. Page 2-14, Paragraph 1: Please provide a source for the temperature map shown in Figure 2.1.5.
Completed. See Section 2.1, paragraph 4 and Figure 2.1.5.
13. Page 2-14, Paragraph 4, Line 4: Should this refer to Crane, Pecos, and Ward counties and not include Loving? Please verify and correct as needed.
Completed. See Section 2.1, paragraph 7.
14. Page 2-29, Paragraph 3: Please clarify this paragraph. It is not clear how and which sediments show evidence of changes in sea level while remaining above sea level.
Completed. See Section 2.2, paragraph 9.
15. Page 2-29, Paragraph 6: Please discuss the "collapse" and alluvial infilling in more detail.
Completed. See Section 2.2, paragraph 12.
16. Page 2-30, Paragraph 4: Please specify the directional orientation of the faults.
Completed. See Section 2.2, paragraph 16.
17. Page 2-31, Paragraph 1: Please change "Pecos Alluvium Aquifer" to "Pecos Valley Aquifer".
Completed. See Section 2.2, paragraph 15.
18. Page 4-1, Paragraph 4: Please provide a brief description of "Project Gnome".
Completed. See Section 4.1.1, paragraph 2.
19. Page 4-10, Paragraph 1: It would be helpful to provide additional information related to the interpretation of the Belding-San Simon Trough as a graben instead of a dissolution trough since it deviates from the historical interpretation. This could include reviewing the timing of when extension likely occurred and whether it is supported by other features in the region. Alternatively, if the interpretation is uncertain and the distinction between a dissolution trough and a graben is not very significant for the purposes of modeling, the graben can be presented as another possibility. In this case, the evidence for each should be discussed, one interpretation picked for the purpose of the report, and the significance for the model between the two interpretations explained. Also, it would be helpful to acknowledge the correlation between the location of the Capitan Reef and the location of the trough and whether or not it is significant.
Completed. See Section 4.2.1, paragraphs 9 through 13.
20. Page 4-10, Paragraph 3: When modifying the thickness of cells to the minimum of 100 feet and maximum of 1000 feet, please clarify which surface (the Rustler top or base) was assumed to be correct and which will be adjusted for the model.
Completed. See Section 4.2.1, last paragraph and Section 6.2, last paragraph.
21. Page 4-35, Paragraph 1: The absence of wells in structural subdomain 9 may be related to the occurrence of a thick portion of the Pecos Valley Aquifer that overlies the subdomain and may not reflect low transmissivity. Please provide additional justification for low transmissivity in this area or revise the text to reflect the uncertainty.
Completed. Statement removed from text. See Section 4.3.1, paragraph 3.

22. Page 4-37, Paragraph 1: Please remove the last sentence in this paragraph. The two wells may not lie within the official boundaries of the Rustler Aquifer but they are within the proposed model area and could be of importance to the overall flow system.
Completed. See Section 4.3.2, paragraph 1.
23. Page 4-37, Paragraph 4: Based on data presented in this section it may be more prudent to select a time period other than 1980 through 1997 for transient calibration. See general comments above.
Completed. See Section 4.3.3, last paragraph.
24. Page 4-40, Paragraph 4, Line 7: Should this read "indicates the potential for downward flow" instead of "upward flow"? Please review and update as needed. 25. Page 4-75, Paragraph 4: Please revise the second sentence to clarify which stratigraphic units were investigated in the Corbet (2000) study.
Completed. See Section 4.3.4, paragraph 6.
25. Page 4-75, Paragraph 4: Please revise the second sentence to clarify which stratigraphic units were investigated in the Corbet (2000) study.
Completed. See Section 4.4.1, paragraph 2.
26. Page 4-143, Paragraph 1: Please consider using a Piper diagram to illustrate the range of groundwater chemical compositions discussed in this paragraph.
Completed. See Section 4.8, paragraph 1 and Figure 4.8.1.
27. Page 4-146, Paragraph 2: Please correct the reference in this paragraph to Figure 4.8.2 instead of Figure 4.8.3. Also, please add a discussion in this section of how the groundwater chemistry in the Rustler Aquifer informs and supports (or doesn't) the conceptual model of the flow system.
Completed. See Section 4.8.2, paragraphs 3 and 4.
28. Page 5-1, Paragraph 2: Please change " ... and consists of ... " to " ... and the boundaries defined by the TWDB consist of ... ".
Completed. See Section 5.0, paragraph 2.
29. Page 5-1, Paragraph 2: Please change "The formation outcrops ... " to "In Texas, the formation outcrops ... ".
Completed. See Section 5.0, paragraph 2
30. Page 5-3, Paragraph 1: Please add a statement that the post-sedimentary faulting coincides with, but does not apparently extend through, the underlying Capitan Reef Complex.
No change. It is beyond the scope of the Rustler Aquifer GAM to comment on the structure of the Capitan Reef Complex.
31. Page 5-5, Paragraph 2: Please delete this paragraph as it repeats information that appears in the previous two paragraphs.
Completed.

Figures and Tables

1. Figure 2.0.8: Please update caption with "(GCD)" after Groundwater Conservation Districts so abbreviations in figure are explained.
Completed. See Figure 2.0.8.
2. Figure 2.1.1: Please correct spelling of "Sacramento" label in figure.
Completed. See Figure 2.1.1.
3. Figure 2.1.8: Please correct the spelling of "Reeves" in the title of the graphs for stations 417481 and 419106.
Completed. See Figure 2.1.8.
4. Figure 2.2.1: Please replace "shady" with "study."
Completed. See Figure 2.2.1.
5. Figure 4.5.1 and Figure 4.5.3: Please correct the spelling of "reservoir" in legend.
Completed. See Figures 4.5.1 and 4.5.3.
6. Figure 4.5.6: Please update the list of figures at the beginning of the report to include Figure 4.5.6.
Completed. See the List of Figures.
7. Figure 4.8.6: Please correct the spelling of "Fluoride" in legend.
Completed. See Figure 4.8.7.
8. Table 4.1.1: Please correct spelling of "mudstone" in Tamarisk Member. Also suggest adding in columns for Los Medaiios and Virginia Draw since text in Section 4 cites these members repeatedly.
Completed. See Table 4.1.1. A footnote was added to indicate the Los Medaños and Virginia Draw members.
9. Table 4.3.5: Please specify that the site numbers reference figures 4.3.9, 4.3.10, and 4.3.11.
Completed. See Table 4.3.5.
10. Tables 4.4.2 and 4.4.3: Please correct spelling of "Tessie" to "Tessey".
Completed. See Tables 4.4.2 and 4.4.3.
11. Table 4.8.1: Please update footnote 1 to "United States Geological Survey" instead of "United State Geological Survey".
Completed. See Table 4.8.1.

Geodatabase

1. Throughout Geodatabase: Please remove empty geodatabase elements (for example, SUBHYD_ WaterLevels).
Completed.

2. Boundary - GCD_Rustler: Though this area is not shown in Figure 2.0.8, the boundaries of Jeff Davis Underground Water Conservation District and Presidio County Underground Water Conservation District were recently clarified by the Texas Attorney General to be coextensive with Jeff Davis and Presidio counties, respectively. Please update the district boundaries in the geodatabase accordingly.
Completed. See shapefile GCD_Rustler_v2 in Boundary Feature Database.
3. Boundary - figure_extent: Please update the figure_extent coverage as it does not match the figure extent boundary shown for most other coverages (for example, physio_Rustlec GAM).
Completed. See shapefile figure_extent in Boundary Feature Database.
4. Climate - precip_station_rustler: Please project this dataset into the GAM projection.
Completed. See shapefile precip_station_rustler in Climate Feature Database.

Suggestions:

1. Page 1-1, Paragraph 2, line 4: Please change "is" to "in" for the following, " ... Culberson County and occurs is sub crop" .
Completed. See Section 1.0, paragraph 2.
2. Page 2-1, Paragraph 5, Line 1: Please remove River from the sentence, as Rio and River are redundant words.
Completed. See Section 2.0, paragraph 4.
3. Page 2-14, Paragraph 1, Line 4: Please correct the spelling of "orographic".
Completed. See Section 2.1, paragraph 4.
4. Page 2-29, Paragraph 4, Line 1: Please change "evidence" to "evidenced."
Completed. See Section 2.2, paragraph 10.
5. Page 3-2, Paragraph 2, Line 6: Please change "other" to "another."
Completed. See Section 3.0, paragraph 4.
6. Page 4-4, Paragraph 1, Line 3: Suggest either stating "as demonstrated by studies" or "based upon studies" instead of "as demonstrated based upon studies".
Completed. See Section 4.1.2, paragraph 2.
7. Page 4-10, Paragraph 2, Line 12: Please change "due" to "do."
Completed. See Section 4.2.1, paragraph 9.
8. Page 4-35, Paragraph 2, Line 7: Please change " ... is consist with ... " to " ... is consistent with ... ".
Completed. See Section 4.3.1, paragraph 4.
9. Page 4-75, Paragraph 6, Line 4: Please capitalize "rustler" in Rustler Aquifer.
Completed. See Section 4.4.1, paragraph 4.

Final Groundwater Availability Model for the Rustler Aquifer

10. Sections 4.5 and 4.7.1: Suggest reviewing <http://pecosbasin.tamu.edu/assessmentprogram> Pecos River Basin Assessment for possible ungaged stream flow information and studies on vegetation within the Pecos Basin.

Completed. The assessment was reviewed and data relative to the Rustler Aquifer were not found.

This page intentionally left blank.

APPENDIX C

Groundwater Availability Model Comments and Responses

Final Groundwater Availability Model for the Rustler Aquifer

This page intentionally left blank.

Appendix C

Comments on the March 2012 Draft Final Report for the Rustler Aquifer Groundwater Availability Model

Conceptual Model Draft Report Comments:

1. Conceptual model report review comment 5 was not fully addressed: please update figures 2.2.2, 2.2.4, 2.2.5, 4.3.12 to 4.3.15, and page 5-4, paragraph 2, line 5 to refer to the Edwards-Trinity (Plateau) Aquifer, as applicable.

Completed.

2. Conceptual model report review comment 15 was not fully addressed: please include more discussion on the collapse and alluvial infilling of the trough.

Completed. See Section 2.2, paragraph 12.

3. Conceptual model report review comment 27 was not fully addressed: The draft report includes a good discussion of the general water quality as it relates to MCLs, health, and environmental hazards; however, the report did explicitly discuss whether the data support the conceptual model or not. For example, one could compare the Rustler facies with those of the overlaying and underlying aquifers. Please clarify if any insight was provided by isotope data; for example, two Pecos County Rustler wells have shown old water, which is inconsistent with designating the Tessey outcrop in the Glass Mountains as an active recharge area.

Partially completed. The use of geochemistry and chemical facies to study the potential connection of aquifers in the Edwards-Trinity Plateau and the Pecos Valley is currently the topic of a separate study being funded by the TWDB. However, a brief discussion of how Carbon-14 data are consistent with TDS data has been included in Section 4.8.2, paragraph 4 with some additional discussion in Section 5.0, paragraph 13.

Many studies have conceptualized the Glass Mountains as being a recharge zone to the Edwards Trinity (Plateau) and Rustler aquifers including but not limited to Armstrong and McMillion (1961), Small and Ozuna (1993), Boghici (1999), Uliana and Sharp (2001), Uliana et al (2007), Harden and others (2011) and Bumgarner and others (2012). Most Rustler isotopic samples collected and analyzed in these studies have shown the Rustler Aquifer waters to be “older” waters not reflecting recent recharge with the potential exception of samples that reflect mixing of older and newer waters such as may occur at Diamond Y Springs. These results are wholly consistent with the conceptualization of recharge in the Glass Mountains given that integrated flow path travel times over the distance of 10’s of miles would be expected to take thousands of years especially when considering mixing of groundwater along an integrated flow path.

4. Conceptual model report review comment 29 was not fully addressed: Please review and adjust as requested.

Completed. See Section 5.0, paragraph 2.

Draft Final Model Report Comments:

1. Page 1-1, and throughout the report: please replace reference to Ashworth and Hopkins (1995) and to Boghici and van Broekhoven (2001) in the context of Rustler Aquifer delineation with TWDB numbered report 380 (2011).

Partially completed. No change was made when the text discusses that the extent of the Rustler Aquifer is defined by the portion of the Rustler Formation having a total dissolved solids concentration of less than 5,000 milligrams per liter because this point is not made in report 380.

2. Page 1-2, paragraph 1, line 1: please replace the reference to the 2007 State Water Plan with 2012 State Water Plan, if feasible.

Completed. See Section 1.0, paragraph 5.

3. Page 1-4, figure 1.0.1: please add "Balcones Fault Zone" or "BFZ" next to "Edwards" in the legend.

Completed. See Figure 1.0.1.

4. Page 1-5, figure 1.0.2: please replace "West Texas Bolson" with "West Texas Bolsons".

Completed. See Figure 1.0.2.

5. Page 2-17, paragraph 2, line 6 and page 3-4, paragraph 2, line 5, and other places in text: please note that it is our understanding that it was Armstrong and MacMillion (1961) who described the faults near Belding, not Boghici (1997). Boghici (1997) found evidence of faulting at Diamond Y only. Please attribute references to the Belding faults to Armstrong and MacMillion (1961).

Completed. See Section 2.2, paragraph 2 and Section 3.0 paragraphs 5 and 9.

6. Page 2-30, paragraph 3, line 1: please cite the source for the cross-sections shown in figures 2.2.4 through 2.2.6. In addition, please clarify if they were developed expressly as part of this project or were derived from a previous study and provide citations, as applicable.

Completed. See Section 2.2, paragraph 15.

7. Page 3-7, figure 3.0.1: please add Armstrong and MacMillion (1961) as a source of information in the figure caption.

Completed. See Figure 3.0.1.

8. Page 4-1, paragraph 2, line 3: please replace reference to Boghici and van Broekhoven (2001) with TWDB numbered report 380 (2011).

No change. Report 380 does not state that the Rustler Aquifer is defined as the portion of the Rustler Formation with a total dissolved solids concentration of less than 5,000 milligrams per liter.

9. Page 4-7, paragraph 3, line 3 & page 4-12, paragraph 1, line 3: please replace "Meyers" with "Meyer".

Completed. See Section 4.2.1, paragraph 2 and Section 4.2.2, paragraph 1.

10. Page 4-10, paragraph 3, lines 3-4: please provide examples of units overlaying the Rustler whose thickness and stratigraphy suggest tectonic movement.

Completed. See Section 4.2.1, paragraph 11.

11. Page 4-12, last two lines: our review of the GAT sheets indicates Dewey Lake Formation in the Glass Mountains does not outcrop in this area, please clarify and adjust text as needed.

Completed. See Section 4.2.2, paragraph 2. The text states that the Dewey Lake was ASSUMED to be present in the Glass Mountains. The reference to Figure 2.1.3 in this sentence was removed.

12. Page 4-13, line 1: replace "Edwards-Trinity (Plateau) Formation" with "the Cretaceous Bissett Conglomerate or the Trinity Group".

Completed. See Section 4.2.2, paragraph 2.

13. Page 4-15, paragraph 3, line 1: the "central corridor" is very hard to identify in figure 4.2.1, please update figure with identification of this feature so figure and text agree or provide reference another figure that references this feature.

Completed. See Figure 4.2.1.

14. Page 4-18, paragraph 2, lines 7-8: please clarify the meaning of "increase of sulfate minerals" and its effect on transmissivity.

Completed. See Section 4.2.4, paragraph 4.

15. Page 4-19, top two lines, and elsewhere in the report: please clarify in the text the assumption that equates the presence of halite and other evaporite minerals with low aquifer transmissivities. While this may be the case where the percolation of waters unsaturated with respect to halite results in low transmissivities, in other instances (such as the Ochoan in the study area) evaporite minerals can be easily dissolved, thus increasing formation permeabilities.

Completed. See Section 4.1.2, paragraph 2 and Section 4.2.4, paragraph 5.

16. Page 4-44, 3rd bullet and page 4-74, 3rd bullet: please clarify the assumption that recharge entering the Tessey Formation directly infiltrates to the Rustler through a facies change or does so by recharging the Capitan and then enters the Rustler through cross-formational flow. Both options are discussed throughout the report and appear to be in conflict.

No change. The statement in each of these sets of bullets is related to what was found in the literature related to cross-formation flow into and out of the Rustler Aquifer and does not reflect the conclusions draw as a part of this study.

17. Pages 4-54 to 4-72, all figures in chapter 4: please specify the source of data in all the figure captions as required in Exhibit B of the contract.

Completed. When displayed data were from a specific source, that source was added to the figure caption. When displayed data were developed for this study or where not obtained from a defined source, no source was included in the figure caption.

18. Pages 4-66 to 4-68, Figures 4.3.13 to 4.3.15: please adjust symbols on map to agree with symbols used in the hydrographs so the symbols are consistent when referencing a particular aquifer.

Completed. See Figures 4.3.13 through 4.3.15

19. Page 4-73, paragraph 1, line 4: please add cross-formational flow as a recharge mechanism, especially in areas of intense faulting in text.

Completed. See Section 4.4, paragraph 1. No change was made to this sentence as it deals with sources of recharge to the water table. An additional sentence on recharge via cross-formation flow was added to the end of the paragraph.

20. Page 4-156, figure 4.8.1: please add source of data in the caption.

Completed. See Figure 4.8.1.

21. Page 5.9, Figure 5.0.1: please adjust flow directions to be more consistent with figure 6.4.6 on page 6-37 for assumed flow across faults; for example, instead of flow from 5 to 7b, possibly adjust flow direction from 5 to 4b to 7b.

Figure 5.0.1 was adjusted to be consistent with figure 6.4.6.

22. Page 6-10, last paragraph, lines 5-6: please re-word to justify reasoning for using data from Edwards-Trinity (Plateau) model and include which model version was used.

An additional sentence was added explaining how our comparison of the simulated heads from the available models to observed heads in the area of interest lead us to choose the (Anaya and Jones, 2009) version for use in implementing the general-head boundary condition heads.

23. Page 6-14, Section 6.3.5 last sentence: please eliminate user groups not applicable to historical pumping in Rustler Aquifer; for example, remove municipal, manufacturing, power generation, and mining and change “seven” to “three” user groups. Also update text to note that additional pumping was added during calibration.

Additional text was added to clarify the pumping groups which played no part in the active model area and about altering pumping during calibration.

24. Page 6-17, Figure 6.3.1: please update figure with types of boundaries used, such as no-flow and GHB.

The type of boundary condition was added to the labels on the figure.

25. Page 6-31, Section 6.4.3, last sentence: please note in text that while uniform storativity was assumed, in figures 6.4.7 and 6.4.8 the values vary due to layer thicknesses.

Consistent to the discussion in section 4.6.6 and table 4.6.3, a uniform specific storage value of 1×10^{-6} was used rather than a uniform storativity value. The storativity was then calculated based on $\text{storativity} = \text{specific storage} \times \text{layer thickness}$. This results in the varying storativity values displayed 6.4.7 and 6.4.8. A sentence was added prior to the last sentence in Section 6.4.3 to better clarify the intent and consistency with the conceptual model.

26. Page 9-10, lines 1-2: please replace "2.24" with "9.2.4" and "2.2.5" with "9.2.5".

Corrected.

27. Page 9-23, Figure 9.2.8: please update hydrographs by removing duplicate for well 5216608 and include appropriate hydrograph for well 4660902.

Corrected.

28. Page 9-30, paragraph 3 and following paragraphs: please revise and clarify the wording in this section. It is unclear and confusing concerning which parameter is sensitive to what change.

The subsections of the sensitivity analysis were separated by labeling each subsection with a subsection title describing the simulated metric being evaluated and the model parameters being altered. The labels clarify what each plot represents.

Geodatabase Comments:

1. Please update the following with metadata:
 - NEW_major_aquifers_dd
 - NEW_minor_aquifers_dd
 - wel_1980
 - wel_1990
 - wel_2000
 - ETpet
 - pet_1
 - ModelBoundary (feature dataset)
 - ModelGrid (feature dataset)
 - ModelHydraulicProperties (feature dataset)
 - ModelPumping (feature dataset)
 - ModelResultsSS (feature dataset)
 - ModelResultsTR (feature dataset)

The metadata for the Soil (feature dataset) contains a feature class for major soil unit polygons from the USDA Soil Conservation Service, State Soil Geographic (STATSGO) database; however, the folder is empty. Please update or delete feature class if it was not used.

Completed.

Model Comments :

1. Pages 6-9 to 6-11, Section 6.3.2: discusses using GHBs for vertical boundaries. Please include suggestions in text, appendices, or with model files for developing values for GHBs when using the model for predictive simulations.

An additional subsection (Section 11.3) was added to provide suggestions for developing the predictive model. Text was also added to the conclusions in Section 12 referring to these suggestions.

2. Pages 6-11 to 6-12, Section 6.3.3: discusses using GHB for streams. Please provide list of cells that represent streams and possibly also Red Bluff Reservoir. Also please include suggestions in text, appendices, or with model files for developing values for GHBs for

these surface water features when using the model for predictive simulations and how or when the assumptions should be adjusted.

The only perennial stream intersecting the Rustler Aquifer outcrop is the Pecos River. Additional text was added to explain that, within the GHB package, the GHB cells representing the Pecos River are tagged with the word “Pecos” to differentiate them from the GHB cells representing the Edwards-Trinity (Plateau) and Pecos Valley aquifers which are tagged with the word “ETPwl”. Additional text was also added to explain that the implementation of the Pecos River is considered applicable to predictive simulations.

3. Page 6-14, Section 6.3.5: states some drains were used to represent flowing wells. Please provide a list of drains and identify which drain cells represent springs versus flowing wells.

An additional sentence was added to Section 6.3.5 explaining that, within the drain package, drains representing flowing wells are tagged with the text “fw” followed by the well name while the drains representing springs are tagged with the text “spring” followed by the name of the spring.

4. Report discusses injection wells were used to model recharge for Tessey Formation and flow from the Davis Mountains, please clarify in more detail if assumptions for transient values are applicable for predictive simulations, such as average versus drought conditions, and how or when the assumptions should be adjusted.

Text was added to Section 6.3.4 to clarify that the inflow rates from both the Glass and Davis Mountains are considered long-term rates and that any temporal variability is believed to be dampened due to the distance between the boundary conditions and the developed portions of the Rustler Aquifer. The additional text also states that the calibrated inflow rates are believed to be representative of the inflows that should be used for any predictive model runs.

5. Page 8-13, Table 8.2.4 and page 9-5, Table 9.7.4: please clarify if cross-formational flow includes lateral flow across faults or just vertical flow and if lateral flow represents flow into and out of each zone or also includes lateral cross-formational flow. Please include a list of the cells in the model where the lateral flow across the fault barriers is cross-formational.

Text was add to Section 8.2.4 and Section 9.2.3 to clarify that cross-formational flow represents only vertical flow between model layers (formations) and that lateral flow represents only lateral flow within a given model layer (formation) and that any cross-formational flow that may occur between aquifers at faults is not accounted for in the model.

6. Please update text as needed to provide a clear connection or explanation between what was provided in the conceptual model and what was used in the numerical model. For example, the conceptual model provided a varied storativity distribution (Figure 6.4.7) while the text for the numerical model suggested only one uniform value for Model Layer 1 was used (also see comment 25 for draft report).

Consistent to the discussion in section 4.6.6 and table 4.6.3, a uniform specific storage value of 1×10^{-6} was used rather than a uniform storativity value. The storativity was then calculated based on $\text{storativity} = \text{specific storage} \times \text{layer thickness}$. This results in the varying storativity values displayed 6.4.7 and 6.4.8. A sentence was added prior to

the last sentence in Section 6.4.3 to better clarify the intent and consistency with the conceptual model.

7. Figure 4.3.13 in the Report indicates that all monitoring well clusters have a strong downward flow from the Dockum Aquifer to the Rustler Aquifer within the central portion of the model domain surrounded by the faults and Pecos River (structure domain 7b). However, the model showed upward flow for all transient periods in structure domain 7b (the simulated head difference between model Layers 2 and 1 is attached as Head_Diff.avi for your consideration). We recommend re-calibrating the model to reflect the downward flow in this area. Options you might consider include extending the faults to Model Layer 1 and/or modifying the head/conductance of the general head boundary.

This is considered to be an effect of underestimations in pumping. An additional subsection (Section 9.3.10) was added to the sensitivity analysis to discuss the uncertainty in pumping in the model and the sensitivity of the model behavior to added pumping. A figure showing that even small amounts of additional pumping can reverse the gradients between the Rustler and the Edwards Trinity was also included.

8. The influence of the general head boundary on cross formation flow may have been exaggerated by the model. To evaluate this, the well package (as well as other MODFLOW packages) from the calibrated model has been extended to approximately 500 years with zero pumping for Stress Period 1 and an uniform pumping rate for Stress Periods 2 through 500. This uniform pumping rate changes between different simulations. Drawdown relative to Stress Period 1 is presented below:

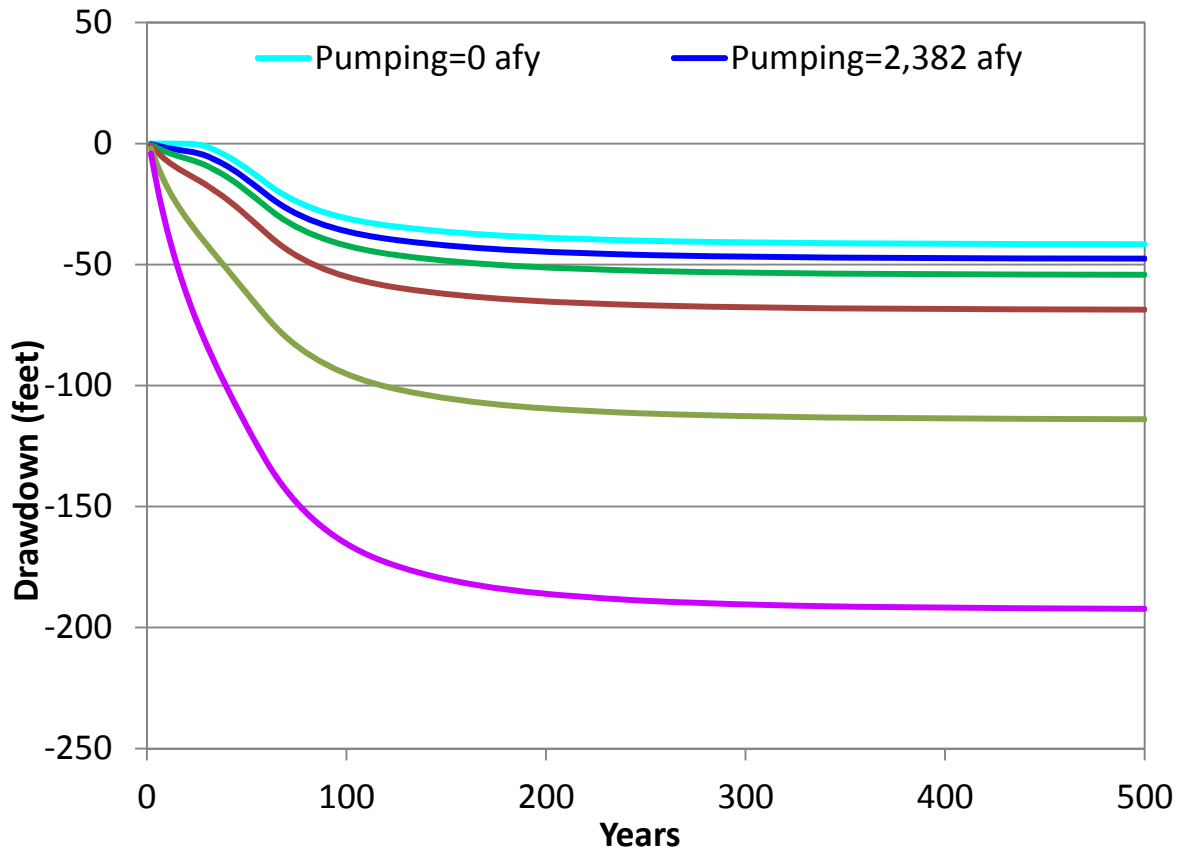

The pumping rate, 4,763 acre-feet per year (acre-feet per year), is the highest total pumping rate for the model domain from the year of 1971 from the calibrated model. Comparing the drawdown curves for 0 and 4,763 acre-feet per year indicates that the general head boundary dominates the simulated water level in the Rustler Aquifer. As a result, this model may not correctly simulate available groundwater from the aquifer, which is one of the main purposes of the model. The Texas Water Development Board recommends one of the following:

- The heads of the general head boundary may need further modification to be more consistent with water level measurements.
- To add another numerical layer above the existing Model Layer 1 to represent the Edwards-Trinity (Plateau) and Pecos Valley aquifers.

A significant effort was made to populate the heads applied to the general head boundaries both spatially and temporally while matching to the best degree the observed heads in the Edwards-Trinity (Plateau) and Pecos Valley aquifers at specific locations and times. This effort included several revisions when the heads were deemed to disagree with observed heads. The vertical hydraulic conductivity of the Dewey Lake and Dockum units (which is also used to calculate the general head boundary conductance) is thought to have considerably more of an impact on the communication between the general head boundary conditions and the Rustler Aquifer than the addition of another model layer without changes to the hydraulic parameterization. The Edwards-Trinity (Plateau) and Pecos Valley aquifers are much more prolific with recharge in excess of 1 million acre-feet per year (Table 9.2 in Anaya and Jones, 2009) while the pumping in the Rustler Aquifer is estimated never to have exceeded 5,000 acre-feet per year. Pumping from the Rustler aquifer is, therefore, not expected to affect the heads in the Edwards-Trinity (Plateau) and Pecos Valley aquifers and it is unnecessary to explicitly simulate the Edwards-Trinity (Plateau) and Pecos Valley aquifers with an additional model layer. An additional subsection (Section 9.3.11) was added to the sensitivity analysis to discuss the uncertainty and sensitivity of the Rustler Aquifer heads to changes in the vertical conductivity of the Dewey Lake and Dockum units.

Suggestions for Report:

1. Exec Summary, page xx, paragraph 2, line 3: spelling error; please replace "affects" with "effects".

Completed. See Executive Summary, paragraph 5.

2. Page 3-3, paragraph 2, line 6: please replace "calcoim" with "calcium".

Completed. See Section 3.0, paragraph 7.

3. Page 4-35 paragraph 1, line 4: please replace "shows" with "show".

Completed. See Section 4.3.1, paragraph 4.

Final Groundwater Availability Model for the Rustler Aquifer

4. Page 4-34, paragraph 3, lines 3-4: suggest replacing "maximum water level" with "highest hydraulic head".

Completed. See Section 4.3.1, paragraph 2.

5. Page 4-69, figure 4.3.16: Capitan Reef well appears in legend but is not shown on the map, please adjust so legend and figure are consistent.

Completed. See Figure 4.3.16.

6. Page 4-123, paragraph 2, line 5: please replace "consistently" with "consistency".

Completed. See Section 4.7.2, paragraph 7.

7. Page 4-161, figure 4.8.6: please add "as N" after "milligrams per liter" in figure caption.

Completed. See Figure 4.8.6.

This page intentionally left blank.

APPENDIX D

Final Groundwater Availability Model Comments and Responses

Final Groundwater Availability Model for the Rustler Aquifer

This page intentionally left blank.

Appendix D

Comments on August 2012 Final Report for the Rustler Aquifer Groundwater Availability Model

MEMORANDUM

DATE: October 5, 2012

TO: Texas Water Development Board (TWDB) Contract Administration

FROM: Cindy Ridgeway, Contract Manager

SUBJECT: Review of “Final Groundwater Availability Model Report for the Rustler Aquifer” deliverables for TWDB Contract No. 0904831000

As per the above referenced contract, TWDB received final deliverables on August 31, 2012, for a study to develop a groundwater availability model for the Rustler Aquifer. As part of the contract we have already reviewed and provided comments in June 2011 on the conceptual model report and data collection phase of the project and on the draft final on received March 30, 2012.

The following lists the results of the final review of the final deliverables:

Final Model Report Comments:

1. Page 1-5 West Texas Bolsons wasn't changed on the map, just the legend

Completed. See Figure 1.0.2.

2. Page 4-112 missing opening parenthesis “(“ in caption before Myers; also missing period at end of sentence.

Completed. See Figure 4.6.1

3. Page 14-15 Sigmond needs to be changed to Jigmond

Completed. See page 14-15

4. Second paragraph of Section 9.1.1 at Page 9-1 states "No grid blocks within the Rustler Aquifer contained coincident wells." However, for example S-39 and S-40 are located at the same model cell (2,337,291), AND r-32 AND r-33 are located in the same model cell (2,339,235).

Completed. See Section 9.1.1, paragraph 2. A change to the implementation of the pumping made this statement obsolete.

Geodatabase Comments

1. As noted in the draft final review the following are missing metadata:

- NEW_major_aquifers_dd
- NEW_minor_aquifers_dd
- wel_1980
- wel_1990
- wel_2000
- pet_1
- ModelResultsTR (feature dataset)

Completed. Metadata has been added to the listed items.

2. The following are missing metadata:

- GMA_Rustler
- WPC_model_boundary
- Kh2_test
- Layer_1_kh
- Layer_1_khCopy (this should probably be removed from geodatabase)
- Recharge
- Subhyd_other_formation_wls
 - Pet_1 was removed

Completed. Metadata has been added to the listed items.

3. No data in the following Datasets or Raster Catalog

- Geomorphology (dataset)
- RechargeGrids (Raster Catalog)
- Geophysics (dataset)
- Soil (dataset)

Completed. The listed datasets and raster catalog have been removed.

Model Comments

The file `modflow_200afy.zip` contains MODFLOW-NWT model input/output files dated August 2012 for a sensitivity analysis. This model was used by INTERA to test the cross-formation flow at three pumping wells in Zone 7B. These files are new since our last review by TWDB. INTERA added pumping at three wells, each with an increasing pumping rate of 200 acre-feet per year. This increasing pumping reversed the hydraulic gradients from upward to downward at the three wells and their vicinity.

1. Content of the readme file in this folder and Figure 9.3.22. Please clarify if the readme file for `mudflow_200afy.zip` should state that the simulation was run for 91-stress period or a transient simulation time of 90 years instead of several hundred years as noted previously by INTERA.

Completed. The readme.txt file indeed contained an error in the description of the `modflow_200afy.zip` file. This alternative model includes additional pumping but is only run for the normal transient model duration of 90 years. The “several hundred years” sentence belongs in reference to the `modflow_lowKv.zip` file. The text in the report is correct but the readme.txt file has been corrected.

2. The label under legend in Figure 9.3.22 needs to be changed from 150 gallons per minute to 372 gallons per minute or 600 acre-feet per year (this is the total increasing pumping for three wells).

Completed. See Figure 9.3.22. The figure caption has been corrected to 600 acre-feet per year total pumping at three wells to correctly reflect the additional pumping applied to the alternative model.

The file `modflow_lowKv.zip` contains MODFLOW-NWT model input/output files dated August 2012 for a sensitivity analysis. In this model, INTERA reduced vertical K of Layer 1 and conductance of general heads in Layer 1 by an order magnitude. The purpose of this sensitivity analysis was to see how the reduction impacted the drawdown during long-term pumping in Layer 2. Similar to the above noted comments:

3. Content of the readme file in this folder and Figure 9.3.23. Please clarify if the readme file for `mudflow_200afy.zip` should state that the simulation was run for 91-stress period or a transient simulation time of 90 years instead of several hundred years as noted previously by INTERA.

Completed. This alternative model was run with 91 stress periods but the last stress period is 182,625 days (500 years) in duration as opposed to the 366 day duration of the transient model. The text in the report is correct but the readme.txt file has been corrected to reflect this.

4. INTERA used measured water levels at W-96 in the report to create a hydrograph but they did not use it as calibration target nor could it be found in the geodatabase. Even though the overall calibration does not change much with or without this well please provide the data associated with this well.

Completed. See Figures 4.3.12, 4.3.13, and 9.3.22 and associated text in Section 4.3.4, paragraph 4 and Section 9.3.10, paragraph 2. Three water-level measurements were reported in 1959 at well W-96 and are shown both in Figure 4.3.13 and Figure 9.3.22. The measurements at this well were removed from the target database because a flag had been attached to the well reading “interval extends only to very top of RUS”. We have removed this well from the figures in Sections 4 and 9.