

RECEIVED

SEP 6 2002

TWDB R&PF
GRANTS MANAGEMENT

**TEMPLE/BELTON REGIONAL SEWERAGE SYSTEM
EXPANSION TO THE TOWN OF SALADO
FEASIBILITY STUDY**

Prepared for:

**Brazos River Authority
P.O. Box 7555
Waco, Texas 76714**

Prepared by:

**James Miertschin and Associates, Inc.
P.O. Box 162305
Austin, Texas 78716-2305**

May 2002

JAMES MIERTSCHIN & ASSOCIATES, INC.
ENVIRONMENTAL ENGINEERING
P.O. BOX 162305 AUSTIN, TX 78716-2305 (512) 327-2708

RECEIVED
SEP 11 2002
WDB R&P
GRANT MANAGEMENT

**TEMPLE/BELTON REGIONAL SEWERAGE SYSTEM
EXPANSION TO THE TOWN OF SALADO
FEASIBILITY STUDY**

Prepared for:

**Brazos River Authority
P.O. Box 7555
Waco, Texas 76714**

May 2002

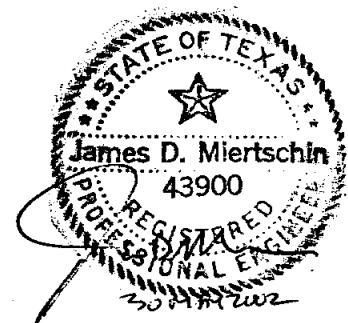

TABLE OF CONTENTS

	Page
1.0 <u>INTRODUCTION</u>	1-1
1.1 BACKGROUND	1-1
1.2 STUDY AREA	1-1
1.3 OBJECTIVES AND SCOPE OF STUDY	1-2
1.4 SEPTIC SYSTEM INVENTORY	1-3
2.0 <u>POPULATION AND WASTEWATER FLOW PROJECTIONS</u>	2-1
2.1 POPULATION FORECASTS	2-1
2.2 PROJECTED WASTEWATER FLOWS	2-2
3.0 <u>COLLECTION SYSTEM ALTERNATIVES</u>	3-1
3.1 GRAVITY SYSTEM	3-1
3.2 PRESSURE SYSTEM	3-1
3.3 VACUUM SYSTEM	3-2
4.0 <u>WASTEWATER TREATMENT AND DISPOSAL ALTERNATIVES</u>	4-1
4.1 TIE-IN TO TBRSS PLANT	4-1
4.2 NEW TREATMENT PLANT OPTIONS	4-2
4.2.1 <u>Treatment Plant and Irrigation Needs</u>	4-2
4.2.2 <u>Effluent Disposal by Irrigation</u>	4-4
5.0 <u>WASTEWATER SYSTEM SCENARIOS AND ASSOCIATED COSTS</u>	5-1
5.1 ALTERNATIVES	5-1
5.1.1 <u>Alternative 1 - Gravity Collection/TBRSS Plant</u>	5-1
5.1.2 <u>Alternative 2 - Gravity Collection/New Plant</u>	5-2
5.1.3 <u>Alternative 3 - Pressure Collection/TBRSS Plant</u>	5-2
5.1.4 <u>Alternative 4 - Pressure Collection/New Plant</u>	5-2
5.2 ESTIMATED COSTS OF ALTERNATIVES	5-3
5.2.1 <u>Estimated Construction Costs</u>	5-3
5.2.2 <u>Estimated Operation and Maintenance Costs</u>	5-3
6.0 <u>ENVIRONMENTAL IMPACTS</u>	6-1
6.1 STUDY AREA	6-1
6.2 "DO NOTHING" ALTERNATIVE	6-2
6.3 CENTRALIZED WASTEWATER SYSTEM	6-2
7.0 <u>INSTITUTIONAL AND FINANCING OPTIONS</u>	7-1
7.1 OPERATIONAL SCENARIOS	7-1
7.2 OPERATOR TYPES	7-1
7.3 EXISTING ENTITIES	7-3
7.4 FUNDING OPTIONS	7-4

**TABLE OF CONTENTS
(CONTINUED)**

7.4.1	<u>Open Market Bonds</u>	7-5
7.4.2	<u>Texas Water Development Board Programs</u>	7-6
7.4.2.1	Clean Water State Revolving Fund (CW-SRP)	7-6
7.4.2.2	State Participation Fund	7-10
7.4.2.3	Texas Water Development Fund (D-Fund)	7-11
7.4.3	<u>United States Department of Agriculture Programs</u>	7-11
7.4.4	<u>Grant Programs</u>	7-12
7.4.4.1	United States Department of Agriculture Grants	7-12
7.4.4.2	Texas Community Development Program Grants	7-13
8.0	<u>NEW SYSTEM IMPLEMENTATION</u>	8-1
8.1	<u>PHASED APPROACH TO IMPLEMENTATION</u>	8-1
8.1.1	<u>Core Business District Phase</u>	8-2
8.1.2	<u>Entire Business District Phase</u>	8-3
8.2	<u>ESTIMATED COSTS FOR PHASED APPROACH</u>	8-3
8.2.1	<u>Estimated Construction Costs</u>	8-3
8.2.2	<u>Estimated Operation and Maintenance Costs</u>	8-3
8.3	<u>COST OF SERVICE</u>	8-4
8.4	<u>SCHEDULE</u>	8-6

APPENDIX A - PRELIMINARY COST ESTIMATES - ALTERNATIVES 1 THROUGH 4

APPENDIX B - PRELIMINARY COST ESTIMATES - PHASED SYSTEM

APPENDIX C - TEXAS WATER DEVELOPMENT BOARD COMMENTS ON DRAFT REPORT

LIST OF FIGURES*

- Figure 1-1 Study Area
- Figure 4-1 Wastewater Treatment and Disposal
- Figure 4-2 Potential Wastewater Treatment Plant and Irrigation Site Locations
- Figure 5-1 Alternative 1 - Gravity Collection/TBRSS Plant
- Figure 5-2 Alternative 2 - Gravity Collection/New Plant
- Figure 5-3 Alternative 3 - Pressure Collection/TBRSS Plant
- Figure 5-4 Alternative 4 - Pressure Collection/New Plant
- Figure 8-1 Proposed Collection System Layouts - Core Business District
- Figure 8-2 Proposed Collection System Layouts - Entire Business District
- Figure 8-3 Preliminary Construction Schedule - Central Business District Option

**Note: Figures are located at the end of each section*

LIST OF TABLES*

Table 1-1	Septic System Inventory
Table 2-1	Population Projections
Table 2-2	Estimated Current Connection Data
Table 2-3	Unit Flow Rates
Table 2-4	Description of Design Flows
Table 2-5	Estimated Wastewater Flows - 30 Year Planning Horizon
Table 5-1	Preliminary Construction Cost Estimates
Table 5-2	Projected Annual Operation and Maintenance Costs
Table 5-3	Estimated Total Annual Costs
Table 7-1	Summary of Funding Options
Table 8-1	Estimated Wastewater Flows - 30 Year Planning Horizon
Table 8-2	Preliminary Construction Cost Estimates - Phased Approach
Table 8-3	Projected Annual Operation and Maintenance Costs - Phased Approach
Table 8-4	Estimated Total Annual Costs - Phased Approach

**Note: Tables are located at the end of each section*

1.0 INTRODUCTION

1.1 BACKGROUND

This study involved evaluating the feasibility of implementing a regional sewerage system for areas of Bell County that included the Village of Salado and surrounding area. The study was initiated due to locally identified infrastructure needs, public health concerns relating to water quality, and the failing on-site septic systems in the commercialized area of Salado.

The framework for the study was developed by the Brazos River Authority (BRA), with input from Bell County officials and local representatives of the Salado Business District Wastewater Advisory Committee. Fifty percent of the study's cost was funded through a grant from the Texas Water Development Board (TWDB). Financial support was also provided by the BRA and a group of interested businesses located within the study area.

After the inception of the study, the Salado community has incorporated into the Village of Salado. Although the study may be a useful tool and the findings and the results of this study, if implemented, would impact the Village of Salado, this study was neither commissioned nor funded by the Village of Salado.

1.2 STUDY AREA

The study area includes the Salado Central Business District and surrounding areas. The Village of Salado is located in Bell County, Texas, approximately 10 miles south of Belton. Salado is a small town with an estimated population of 1,636 within the Census Designated Place (CDP) and an estimated additional 2803 outside the CDP. Figure 1-1 shows the general location of the study area. Numerous retail shops, bed and breakfast establishments, and restaurants make up an area within the town identified as the Central Business District. The town has become a popular tourist destination and is readily accessible from the Austin, Waco, Killeen and Temple/Belton regions. This has resulted in increased demands on the existing septic systems of the Central Business District.

None of the study area has a public sewerage collection systems or centralized treatment facilities. Most of the area outside of the Central Business District consists of single family homesites, large tracts of agricultural land and undeveloped acreage.

There exists one privately owned and operated wastewater treatment facility, located at Salado Inn, and an estimated 1,392 individual septic systems located throughout the study area. The treatment facility at Salado Inn is over 20 years old and has a TNRCC permit that allows discharges directly into Salado Creek, however, the effluent is currently being used for irrigation of agricultural land. Many of the septic systems located in the Central Business District are aging and will fail to meet the demands required by current regulations when replacement or rehabilitation is necessary.

1.3 OBJECTIVES AND SCOPE OF STUDY

The present study was developed to evaluate the feasibility of providing regional wastewater service to the area surrounding Salado. The goal of centralized wastewater service would be to eliminate the dependence upon onsite disposal systems and thereby improve stream water quality in Salado Creek.

The scope of the study included the following major items:

1. Develop population and wastewater flow projections for the study area.
2. Identify collection system alternatives.
3. Identify treatment system alternatives.
4. Develop alternative wastewater service scenarios for the study area.
5. Determine costs of alternatives.
6. Examine environmental impacts.
7. Evaluate operational alternatives.
8. Evaluate funding mechanisms.
9. Develop an implementation plan and schedule.

1.4 SEPTIC SYSTEM INVENTORY

The scope of the present study includes a general inventory of existing septic systems. It is not feasible to map or tabulate the details of every onsite system in the study area, since there are no comprehensive records available. Many of the systems were installed in years before records were kept by the Bell County Health Department. Records of existing systems vary in their detail regarding the nature, sizing, and location of individual septic system installations.

The study area includes both residential and commercial-type systems. For the most part, it is the commercial septic systems that represent the larger flows and the greater potential for problems. For the present study, a representative inventory of many of the larger, commercial septic system installations was conducted. Records were obtained from the Bell County Health Department files and information regarding system sizing and flows was tabulated.

Details of this representative inventory of commercial septic system installations are displayed in Table 1-1. The table includes a description of the business, location, design flowrate, treatment unit, drainfield size, and date of permit issuance.

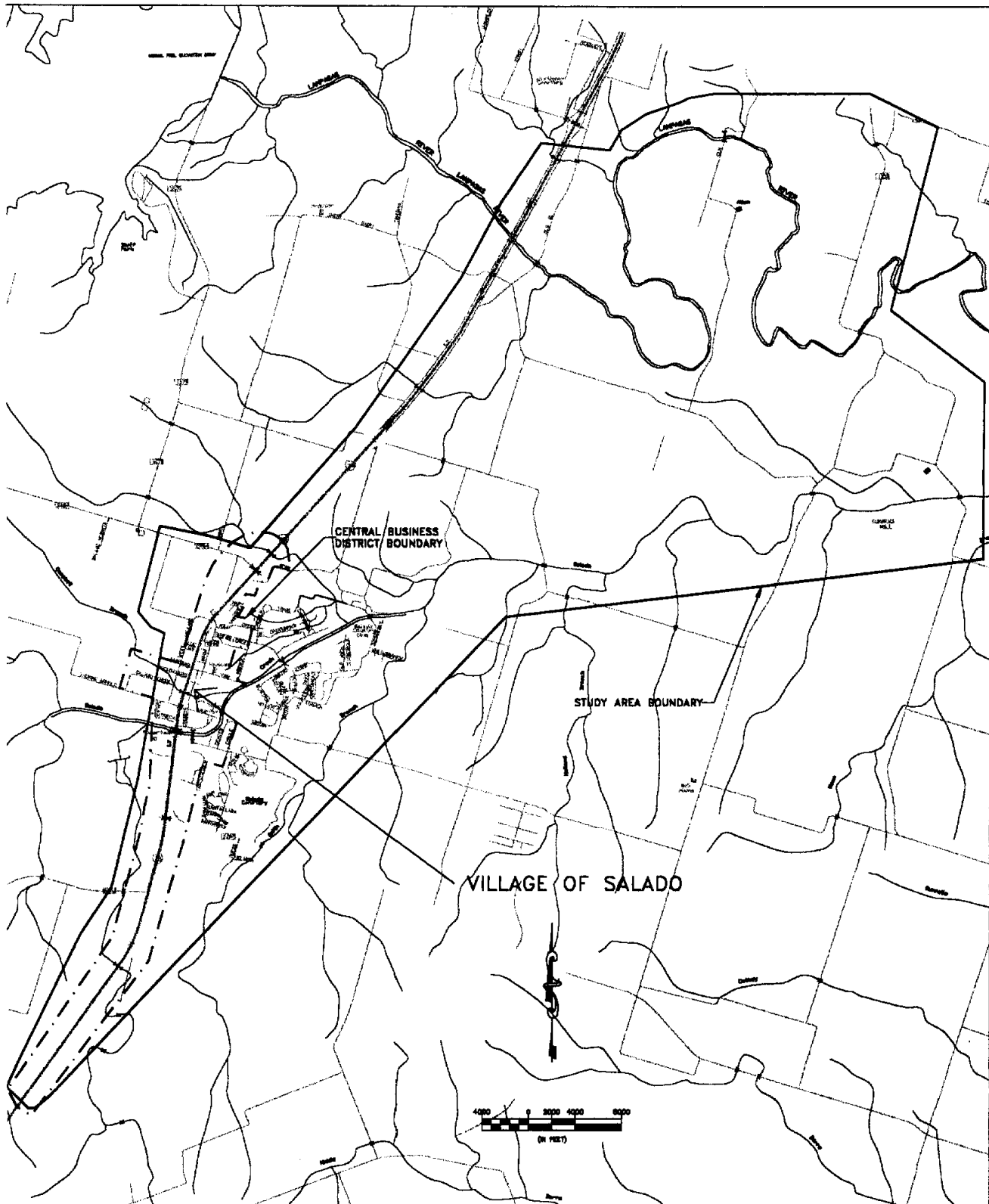

JAMES MIERTSCHIN & ASSOCIATES, INC
ENVIRONMENTAL ENGINEERING

FIGURE 1-1
STUDY AREA

**Table 1-1
Septic System Inventory**

Owner	Type	Description	Location	Wastewater Flowrate (gpd)	12 Month Average	Overall Average	Treatment Unit	Disposal Area Installed (ft ²)	Date of Permit	Soil	Disposal
Carriage House (Stillwell Investments)	Commercial	Office buildings	Main Street	1,000 design	---	---	Hoot 1,000 gpd aerobic, 750 gallon tank	12,576	23-Dec-99	Class IV	drip
Patty Thomas	Commercial	Bed and breakfast, 750 ft ² , 2 bedrooms	642 N. Main	180	2,719	2,134	750 gallon tank	962	10-Feb-00	Type II	conv
Patty Thomas	Commercial	Bed and breakfast, 1,100 ft ² , 2 bedrooms	642 N. Main	180	2,719	2,134	750 gallon tank	744	26-Mar-00	Types II & III	conv
Dan and Millie Donaldson	Commercial	Office buildings, coffee shop, 7,226 ft ²	417 N. Main	224	12,025	8,404	G 500 aerobic, 500 gallon tank, 750 gallon tank	4,074	11-Mar-98	Type IV	drip
Tim Brown	Commercial	Dentist's office	2 N. Main	150	20,087	15,266	750 gallon tank	750	03-Aug-99	Type II	conv
Bill Bartlett	Commercial	Office building	918 N. Main	32	10,521	10,521	750 gallon tank	425	19-Jul-99	Type III	conv
Bob Shull	Commercial	Restaurant	N. Main	1,820	---	---	1 aerator, 4 aerobic units, 4 X 500 gallon tanks	28,438	12-May-97	Types III & IV	irrig
Floyd Lee	Commercial	Confectionary, apartment	Main Street	---	---	---	1,000 gallon tank	750	09-Nov-93	DeB	conv
Steve and Natalie Tolley	Commercial	Office building	405 N. Main	---	8,120	5,214	1,000 gallon tank	558	29-Oct-93	DeB	conv
Perry Dalby	Commercial	Shop	831 N. Main	---	---	---	750 gallon tank	600	25-Jul-86	PrB	conv
Perry Dalby	Commercial	Tearoom restaurant	302 N. Main	---	11,396	9,412	1,000 gallon tank	655	05-Mar-93	PrB	conv
Jim Garrett	Commercial	Antique shop	702 N. Main	---	9,383	7,797	1,000 gallon tank	1,000	02-Nov-92	PrB	conv
Judy Tyler	Commercial	Tearoom and dress shop	Main Street	---	---	---	1,000 gallon tank	891	26-Oct-92	PrB	conv
George Kolb	Commercial	Inn	Main Street	---	22,417	21,178	1,000 gallon tank	1,200	21-Jun-91	DvB	conv
Jim Kelley	Commercial	Post office	820 N. Main	---	13,036	5,375	1,100 gallon tank	468	02-May-88	DeB	conv
Steve Pylant	Commercial	Unknown	N. Main	428	5,770	2,214	600 gpd	7,850	29-Sep-97	Type II & IV	irrig
Victor Means, Jr.	Commercial	Unknown	N. Main	---	10,465	6,762	1,000 gallon tank	1,370	02-Aug-94	DeB	conv

**Table 1-1
Septice System Inventory**

Owner	Type	Description	Location	Wastewater Flowrate (gpd)	12 Month Average	Overall Average	Treatment Unit	Disposal Area Installed (ft ²)	Date of Permit	Soil	Disposal
Gary Bartlett	Commercial	Office	600 N. Main	---	3,937	1,218	500 gallon tank	414	27-Sep-95	PrB	conv
George Kolb	Commercial	B&B and meeting room	Main Street	---	---	---	1,250 gallon tank	1,458	31-Jul-97	PrB	conv
1st Baptist Church	Church	Church	201 Main	---	9,459, 43,768	13,600, 27,224	1,000, 350 grease trap	200	19-Nov-90	Bf	graveless pipe
Becky McAuley	Commercial	Business	Blue Jay	---	---	---	750 gallon tank	470	12-May-95	PRB	conv
Richmond Homes	Commercial	Hotel	200 N. Main	---	28,873	12,093	1,000 gallon tank	798	03-Jun-94	DeB	conv
Bobby Norwood	Residential	3 bedroom house	Main Street	---	---	---	1,000 gallon tank	960	10-May-83	DeB	conv
Steve Wesson	Commercial	Guest houses	Main Street	---	---	---	750 gallon tank	600	19-Jul-84	PrB	conv
Killeen Savings and Loan	Commercial	Savings and Loan	---	---	---	---	1,100 gallon tank	1,071	21-Jul-78	Cl, S	conv
Salado First National Bank	Commercial	Bank	Main Street	---	2,020	5,235	1,650 gallon tank	750	28-Jan-80	---	conv
William Hilger and Judge Reavley	Residential	2 bedroom house	Main Street	---	---	---	1,000 gallon tank	516	06-Apr-77	SC	conv
John Hendrickson	Residential	2 bedroom house	Main Street	---	---	---	1,100 gallon tank	625	12-Apr-84	DeB	conv
Morris Foster	Commercial	Retail center	Main Street	---	---	---	1,000 gallon tank	765	04-Feb-87	PrB	conv
First Tex Equity	Commercial	Retail stores	Main Street	---	---	---	2,000 gallon tank	1,800	28-Feb-79	Purvis	conv
Bill Stevens	---	---	Main Street	---	---	---	750 gallon tank	555	01-Jan-91	DeB	conv
Chester M. Casey	Commercial	Newspaper	Main Street	---	---	---	750 gallon tank	640	01-Dec-86	Bf	conv
Daybreak Construction	Commercial	---	Main Street	---	---	---	1,000 gallon tank	1,115	14-Mar-91	DeB	conv
Wayne Stillwell	Commercial	Bed and breakfast	Main Street	---	---	---	1,300 gallon tank	750	17-Jul-92	PrB	conv
Salado Future, Inc.	Commercial	Business	Main Street	---	3,732	4,138	900 and 750 gallon tanks	1608	24-May-77	TB	conv
Salado Chamber of Commerce	Commercial	Business	Main Street	---	---	---	1,000 gallon tank	1,614	19-Aug-93	DeB	conv
Tim Brown	Commercial	Office building	Main Street	---	---	---	750 gallon tank	500	28-Mar-94	PrB	conv
Perry Dalby	Commercial	Restaurant	Main Street	---	---	---	1,000 gallon tank	995	20-Apr-81	AE	conv

2.0 POPULATION AND WASTEWATER FLOW PROJECTIONS

The size of wastewater collection, conveyance, and treatment facility systems required to provide adequate sanitary service is proportional to the quantity of generated wastewater flow. The wastewater flows generated by a sanitary sewerage system are a function of the number of users contributing to the system. In the Salado study area, contributing users would include offices, retail shops, churches, restaurants, hotels, schools and residential connections. With an existing sewerage system, current wastewater flows for the area serviced may be obtained by metering and used in estimating future flow. When designing a sewerage system for an area that does not have centralized service, flows must be estimated based on potential connections and their contribution to the total wastewater flow.

Population data is commonly used as a basis for predicting wastewater flow rates. The data is used to estimate the number of residential connections and a per connection flow rate is applied. This is a valid method for estimating total wastewater flows in areas that are predominantly residential. However, this method alone would not be expected to yield accurate estimates of the Salado area wastewater flows due to the many businesses located within the study area. Therefore, a more detailed investigation into the combined effects that businesses and residences will have on wastewater flows was required for this study.

2.1 POPULATION FORECASTS

In 1997, the 75th Texas Legislature enacted Senate Bill 1 (SB1), which called for the development of regional-oriented plans to address the water needs of the State for the next 50 years. This legislation also called for population forecasts across the regions and state to be used for consistent planning data. This data was initially provided by the TWDB and amended if better information could be provided by the Regional Planning Groups.

For this study, the projected population growth within the study area was based on adopted SB1 population forecasts for the Brazos G Regional Water Plan data. The information obtained from the

TWDB, which spans a 50 year planning horizon (year 2000-2050), was interpolated for this study's 30 year planning horizon (year 2001-2031). An average annual growth rate of 1.87% was calculated over the 30 year SB1 data set for the Salado CDP and assumed as the average annual growth rate for the Salado area. Table 2-1 shows the SB1 interpolated population projection data.

2.2 PROJECTED WASTEWATER FLOWS

An initial task for designing a collection and treatment system for this study was to estimate potential current wastewater flows. Since no current wastewater connection data exists for the study area, the basis for the number and type of connections was estimated using a consolidation of data obtained by multiple methods.

Water connection data was utilized as a baseline for estimating the number of potential wastewater connections in the area. There are four water suppliers located within the study area: the City of Belton, Dog Ridge WSC, Salado WSC and Jerrell Schwertner WSC. The predominant supplier in the study area is the Salado WSC. A composite of water connection data within the study area was used as an initial basis for the number of potential wastewater connections. However, site visits verified that this information was incomplete and needed supplementation for a valid representation of potential current wastewater connections within the study area.

Data on businesses located within the study area was also required for estimating potential wastewater flows. Information regarding business type, size and location was obtained from the Bell County Appraisal District. This information was utilized in determining estimated potential wastewater flows contributed by the many businesses located within the study area. The type, size and location of existing businesses that were not included in the information obtained from the appraisal district were estimated during site visits.

An extensive field verification of potential wastewater connections in the study area was performed in order to provide a valid representation of potential current wastewater connections. The location

of existing residences, both included and not included in the water connection data, were noted. All existing businesses, churches and schools were also located and the size and type of businesses were noted using the appraisal district data and site visit estimates. This information was used in calculating potential current and future wastewater flows, and, collection system and wastewater treatment facilities sizing for the study area. Table 2-2 shows the estimated current connection data used as the basis for potential current and projected wastewater flows.

Once the contributing entities were identified and located, they were categorized and appropriate unit flow rate factors were applied. The unit flow rates were based on TNRCC recommended design flows, studies of flow contributions from commercial areas in the city of Austin (*Planning Study Report for Robert E. Lee Road Relief Interceptor Study*, EH&A, 1996), and JMA's experience in Central Texas. Applied unit flow rates per contributing entity category used for this study are listed in Table 2-3.

Different types of system flow conditions were examined and are important in the planning and design of the proposed wastewater collection and treatment facilities. These include average annual daily wastewater flow, average daily peak month flow, and peak instantaneous flow. Table 2-4 describes the function of each flow rate type as used in the design process.

Flows were calculated using an assumed 100% participation by current potential wastewater customers. Contribution rates of flow were then calculated and summed for a current potential average annual daily wastewater flow. This data was then projected in 5 year intervals over the 30 year planning horizon to the year 2031 using the SB1 interpolated average annual growth rate of 1.87% for the study area. Table 2-5 shows the estimated wastewater flows over the 30 year planning horizon.

**Table 2-1
Population Projections**

Year	2001	2006	2011	2016	2021	2026	2031
Salado (CDP)	1,636	1,827	2,033	2,230	2,438	2,629	2,824
Salado WSC (Outside CDP)	2,803	3,648	4,665	5,560	6,559	7,429	8,360
Salado Area Total	4,439	5,475	6,698	7,790	8,997	10,058	11,184

Table 2-2
Estimated Current Connection Data

Item	Residential (dwellings)	Businesses (SF)	School (students)
Central Business District	272	478,883	1,121
Total Study Area	1,262	517,383	1,121

Table 2-3
Unit Flow Rates

Category	Contributing Unit Flow Rate
Retail Businesses	210 gpd/1,000 sf
Office Buildings	40 gpd/1,000 sf
Residential	300 gpd/residence
Schools	10 gpd/student

**Table 2-4
Description of Design Flows**

Flow Type	Description and Comments
Average Annual Daily Flow	Used as a basis for estimating other flows listed below. Serves as a basis for estimating annual operation and maintenance costs for wastewater facilities.
Average Daily Flow During the Peak Month	Would be used to determine the required TNRCC permitted monthly flow for wastewater treatment One parameter used in sizing of treatment unit components.
Peak Instantaneous Flow	Used to determine the capacity of all conveyance facilities. One parameter used in sizing of treatment unit components. Normally listed in the TNRCC permit as the peak 2-hour flow.

**Table 2-5
Estimated Wastewater Flows - 30 Year Planning Horizon**

Year	2001	2006	2011	2016	2021	2026	2031
Study Area Total							
Average Daily	0.493	0.541	0.593	0.651	0.714	0.784	0.860
Avg. Daily Peak Month	0.641	0.703	0.771	0.846	0.929	1.019	1.118
Peak Instantaneous	1.972	2.164	2.374	2.604	2.857	3.134	3.438

Note: Wastewater flow values given in million gallons/day.

3.0 COLLECTION SYSTEM ALTERNATIVES

3.1 GRAVITY SYSTEM

Gravity systems typically consist of large diameter pipes in a non-pressurized system which move sewage by means of gravity; the sewer pipes are installed on a gradient such that the sewage is able to flow downgrade.

There are several advantages to using gravity sewer systems. One advantage is that most contractors have more experience with the construction of gravity systems as compared to other types of sewage systems. Another advantage is that individual residences or businesses are not reliant upon a mechanical devices (pumps) to carry sewage away.

There are some disadvantages to gravity systems. Trenches for gravity lines generally must be very deep to meet regulating codes. This results in a significant construction cost for earthwork. In addition, the cost of piping is higher for gravity systems than for other types of wastewater systems because pipes with higher diameters are more costly than smaller diameter pipes. Topographic constraints in areas with rolling or hilly terrain normally require the use of more lift stations (pumping stations) for transferring wastewater to the treatment facility, which increases project cost.

3.2 PRESSURE SYSTEM

Pressure systems consist of small diameter pipes in a pressurized system, which move wastewater through the use of individual grinder pumps installed at each residence or business.

Several advantages are apparent with the use of pressure sewer systems. One benefit is that sewage can be pumped uphill or downhill, unlike gravity systems which can only move sewage downhill. Therefore, pressure collection systems are commonly used in areas with substantial changes in elevation. This also results in the ability to transfer wastewater to the treatment facilities using fewer

lift stations. In addition, the trenches used for pressure pipes are not as deep as those necessary for proper gravity line installation. Because of this, pressure systems are commonly used in areas with rock substrates.

One disadvantage of pressure systems is that there are more appurtenances installed within pressure systems than in gravity systems. Such appurtenances include air release valves, cleanouts, and isolation valves. Usually the cost of installing the grinder pump and piping connections at the residence will ultimately fall upon the resident. In many instances, homeowners will not want to bear the responsibility of that installation cost, and it may be difficult to get all homeowners within a community to agree to pay the cost of installation.

3.3 VACUUM SYSTEM

The use of a vacuum system was briefly considered in the design of the collection system alternatives for the study area. However, a vacuum system is fundamentally similar to a pressure system, in that small diameter piping is used, but it is under vacuum rather than pressure. Therefore, the pressure system alternative was selected for detailed evaluation in the present study, with the expectation that a vacuum system would be similar in materials and layout.

It should be noted that vacuum-type systems are very uncommon in the Central Texas area. The unfamiliarity with the construction and operation of this type of system would be a major hurdle to be overcome. In addition, the unfamiliarity with constructing this type of system would most likely drive cost higher due to the "uncertainty factor" applied to the contractors' bid estimates.

4.0 WASTEWATER TREATMENT AND DISPOSAL ALTERNATIVES

In addition to the collection system issues described in the preceding section, development of a centralized wastewater system for the study area would necessitate consideration of a wastewater treatment facility and the disposal of effluent. As a general introduction, the present feasibility study will address two fundamentally different approaches to wastewater treatment. One approach would be to tie-in the study area collection system to the existing Temple-Belton Regional Sewer System (TBRSS) wastewater treatment plant located near the northern boundary of the study area. An alternate approach would be to construct a new treatment plant to serve the needs of the study area. If a new treatment plant is constructed, consideration would have to be given to the ultimate disposition of the effluent, namely, whether it would be discharged to an area receiving stream or used for land application in a no-discharge scenario.

4.1 TIE-IN TO TBRSS PLANT

A conceptually convenient solution for wastewater treatment for the study area would be to tie-in the proposed regional collection system to the existing TBRSS plant located on the northern boundary of the study area. The TBRSS plant is a 10.0 MGD treatment facility that is owned and operated by the BRA. The TBRSS plant currently serves as a regional treatment facility for the Temple and Belton municipal areas. The treatment plant is currently processing wastewater at approximately one-half of its design capacity, so, there is more than adequate treatment capacity available for wastewater derived from the present study area.

Tie-in to the TBRSS plant would necessitate construction of a force main from the study area either directly to the plant or to the existing City of Belton collection system infrastructure for subsequent conveyance to the treatment plant. For connection to the City of Belton collection system, it is assumed that the tie-in would occur at the Miller Lift Station on the south side of the collection system.

4.2 NEW TREATMENT PLANT OPTIONS

Wastewater treatment and disposal are key aspects in the feasibility study. There is presently only one existing wastewater treatment plant in the study area (Salado Inn), and it has no additional capacity. The existing plant could either be incorporated into a regional system or operated independently. The present study was formulated with the assumption that the Salado Inn wastewater flows would be incorporated into the centralized system.

A key initial step in the feasibility study for an areawide wastewater system is evaluation of effluent disposal options and associated effluent parameters. Effluent quality parameters will dictate to a large extent the type of treatment plant to be constructed. Debate in the study area has persisted central to the merits of discharge versus no discharge treatments alternatives. Systems that would discharge would typically be required to provide very stringent levels of treatment in order to ensure maintenance of water quality in the receiving stream. Conversely, no discharge systems may employ less stringent treatment levels prior to land application of effluent. The type and degree of treatment provided will directly affect overall system costs, and ultimately, feasibility.

Meetings and discussions with the Salado Business District Wastewater Advisory Committee were held to discuss the options of discharge and no discharge. The advisory group was unequivocally opposed to any new effluent discharge scenario. Therefore, this directive dictates effluent disposal by irrigation as a fundamental component of any proposed regionalization scheme. Irrigation schemes have two principal drawbacks: large, relatively flat land areas are required, and a large storage pond is required. However, treatment plant requirements for irrigation use would be less stringent than those for direct discharge of effluent since tertiary treatment would not be necessary.

4.2.1 Treatment Plant and Irrigation Needs

With the directive from the Advisory Group, irrigation disposal is the most feasible disposal option available. For an irrigation disposal system, a secondary level of wastewater treatment is appropriate.

A secondary treatment plant typically entails some type of activated sludge process for biological degradation of organic matter followed by a clarification unit that provides separation of solids by gravity sedimentation. This type of treatment plant represents the most common treatment technology currently in use in this country. Effluent quality required for irrigation is not stringent, a BOD concentration of 20 or 30 mg/L would be suitable. Further, nutrient removal is not necessary and in fact is inappropriate since vegetation on the irrigation site requires nutrients for growth.

Complete-mix activated sludge plants were selected for use in the regionalization study. The aeration basin for a complete mix process is based upon 45 lbs. of BOD per 1,000 cubic feet or less. Alternative configurations are available for an activated sludge plant, including above ground steel tankage in concentric circular units, in-place concrete reactors, and oxidation ditch systems.

A complete-mix activated sludge plant is generally capable of producing a 10/15 (i.e. 10 mg/L BOD and 15 mg/L TSS) effluent with some degree of nitrification (conversion of ammonia nitrogen to nitrate nitrogen). This effluent quality exceeds the minimum quality for an agricultural irrigation application.

Complete-mix activated sludge plants are an attractive alternative for small, intermediate, and larger size facilities.

Treatment plants were sized on the basis of peak month average daily flow derived from the permanent population.

A schematic illustration of a hypothetical plant and disposal site is shown in Figure 4-1. The treatment plant will be situated adjacent to the holding pond for treated effluent at each site. With this arrangement, effluent from the plant will either be pumped or flow by gravity to the storage pond. The plant and pond will be located adjacent to the irrigation site if possible to minimize effluent transmission requirements. However, it may be necessary to purchase a plant site, or plant and pond site, remote from the irrigation field, particularly if irrigation land is leased. For the present study,

it was assumed that an appropriate irrigation site would be procured within a 2 mile radius of the plant and pond site. For planning purposes, a hypothetical plant and pond site was selected, located in the area northeast of the Central Business District. This location is not fixed; it is intended to provide perspective on typical location constraints and enable cost analysis to proceed. The plant and irrigation site can be located anywhere within an approximate 5-mile radius, as shown in Figure 4-2, without significantly affecting the cost estimates developed in the study. The fundamental assumption is that the plant and storage pond can be located within a 3-mile radius of the study area and the irrigation field within a 2-mile radius of the plant site.

4.2.2 Effluent Disposal by Irrigation

An irrigation disposal system is typically designed for effluent consumption by a particular cover crop. The consumption data are then used to calculate land area requirements for irrigation of wastewater. To allow for short term operating conditions, such as an extended period of rainfall, storage of wastewater effluent is usually provided in the form of a holding pond.

For the present analysis, it is assumed that the cover crop for the irrigation field will be coastal Bermuda grass with a winter rye overseed. Based upon experience in the central Texas area, a hydraulic effluent application rate of 3.0 ft/ac/yr was assumed in the present study for irrigation field sizing.

In a final design scenario, a detailed water balance methodology would be applied for site-specific sizing of irrigation fields for wastewater disposal. In some situations, either higher or lower application methods may be appropriate, which would translate to smaller and larger acreage, respectively.

For the present study, it was assumed that 75 days of storage volume would be required, based upon experience in the central Texas area. The number of days of storage directly affects the size of the

effluent holding pond. In a final design scenario, a detailed storage balance methodology would be applied for site-specific sizing of the storage pond.

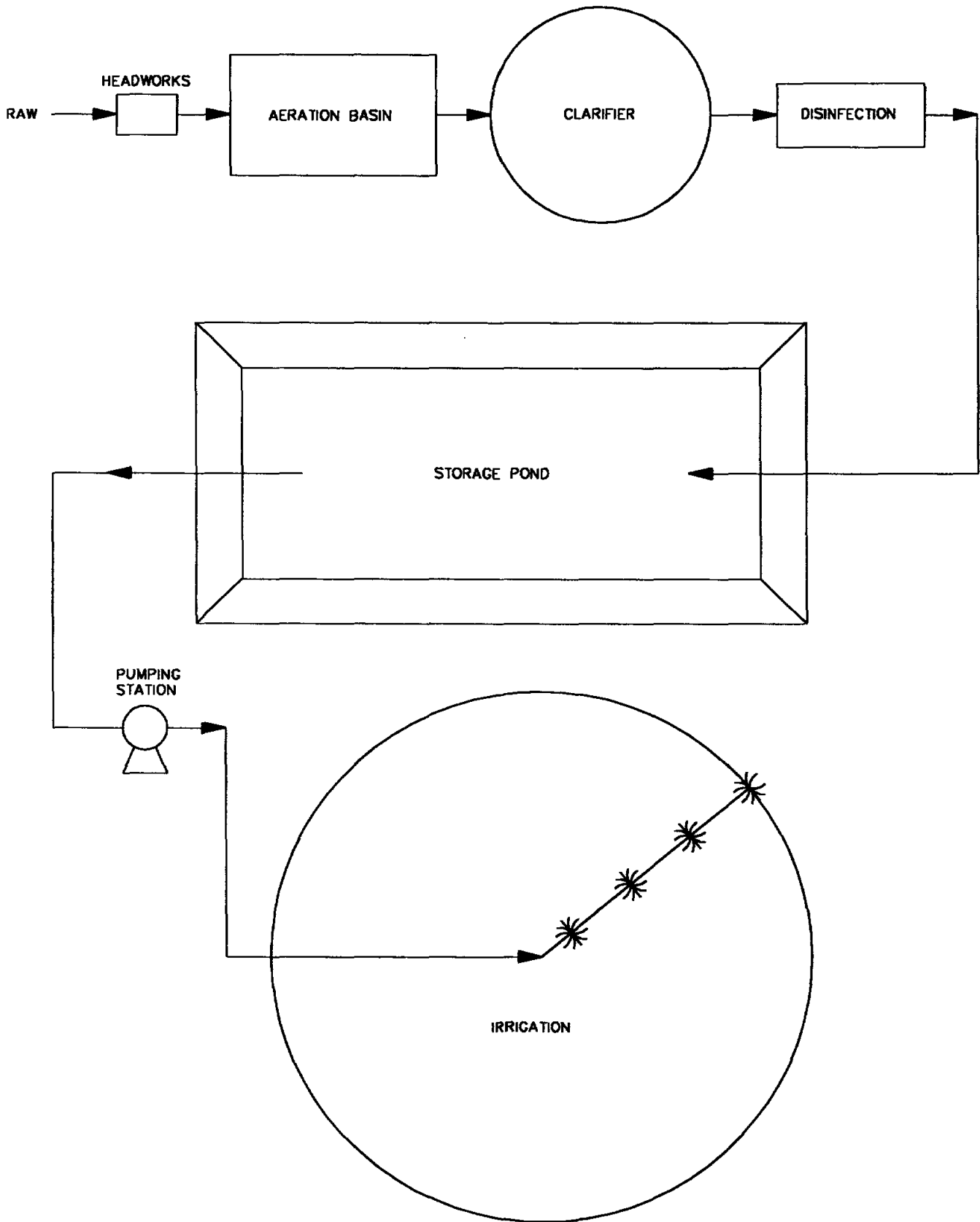
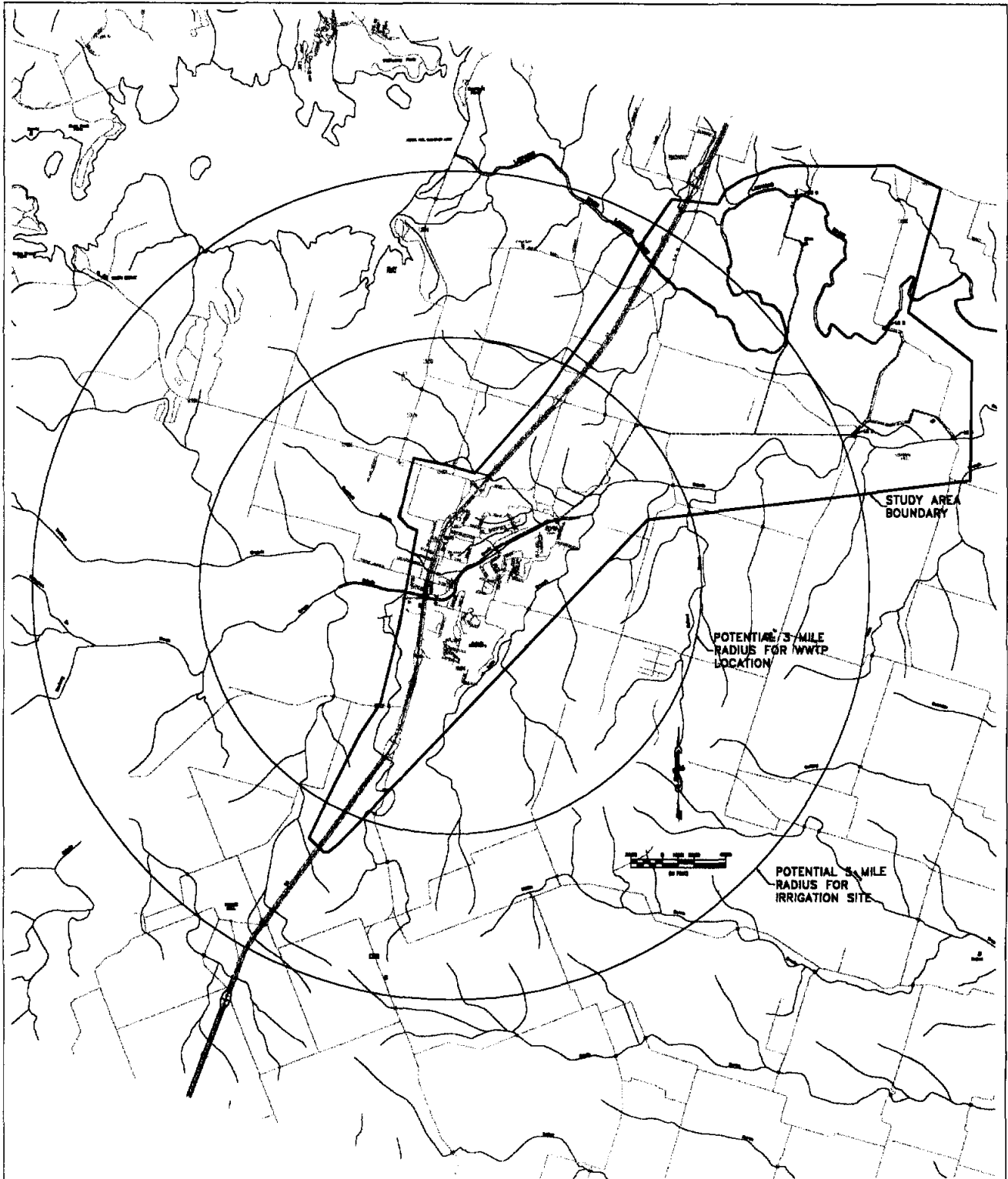

FIGURE 4-1
WASTEWATER TREATMENT AND DISPOSAL



JAMES MIERTSCHIN & ASSOCIATES, INC
ENVIRONMENTAL ENGINEERING

FIGURE 4-2
POTENTIAL WWTP AND
IRRIGATION SITE LOCATIONS

5.0 WASTEWATER SYSTEM SCENARIOS AND ASSOCIATED COSTS

5.1 ALTERNATIVES

Several alternative scenarios were developed for centralized wastewater service for the study area. With respect to the raw wastewater collection system, the alternatives were formulated to consider two options: gravity collection and pressure sewer collection. Two options were also considered for the wastewater treatment aspect: tie-in to the Temple-Belton Regional Sewer System plant and construction of a new wastewater treatment plant for the study area. These options resulted in the formulation of four alternative service scenarios, as summarized below:

Alternative 1 - Gravity collection system, tie-in to TBRSS treatment plant.

Alternative 2 - Gravity collection system, new treatment plant

Alternative 3 - Pressure collection system, tie-in to TBRSS treatment plant

Alternative 4 - Pressure collection system, new treatment plant

A collection system for the study area was conceptually developed for each of the preceding alternatives. The collection system layout included gravity mains and piping, lift stations, and force mains. Preliminary sizing was based upon year 2031 peak daily flows.

The alternative for tie-in to the TBRSS plant included preliminary layout of a force main directly to the facility, located southeast of the City of Belton. The option of a new wastewater treatment plant included the treatment plant, storage pond, effluent pumping facilities, and irrigation equipment.

The analysis of each alternative is described in the following sections.

5.1.1 Alternative 1 - Gravity Collection/TBRSS Plant

Alternative 1 includes a gravity collection system for the entire study area. The layout of this

alternative is depicted in Figure 5-1. The proposed lift stations would be located according to the topographic constraints of the Study Area as a whole and the individual collection areas served. The lift stations would transfer collected wastewater to the existing TBRSS facility via a main lift station and force main.

5.1.2 Alternative 2 - Gravity Collection/New Plant

Alternative 2 includes a gravity collection system for the entire study area. The layout of this alternative is depicted in Figure 5-2. The proposed lift stations would be located according to the topographic constraints of the Study Area as a whole and the individual collection areas served. The collection system lift stations would transfer collected wastewater to a new 1.12 MGD wastewater treatment facility within the study area. For the full study area project, the irrigation system includes an effluent storage pond volume of 198 acre-feet and an irrigation field of 321 acres. For the present study, it is assumed that the land for the irrigation field could be obtained at no cost in return for providing effluent for irrigation to the landowner.

5.1.3 Alternative 3 - Pressure Collection/TBRSS Plant

Alternative 3 includes a pressure collection system for the entire study area. The layout of this alternative is depicted in Figure 5-3. Grinder pumps and small diameter pressure lines would transfer wastewater to the proposed lift stations. The lift stations would transfer collected wastewater to the existing TBRSS facility via a main lift station and force main.

5.1.4 Alternative 4 - Pressure Collection/New Plant

Alternative 4 includes a pressure collection system for the entire study area. The layout of this alternative is depicted in Figure 5-4. Grinder pumps and small diameter pressure lines would transfer wastewater to the proposed lift stations. The lift stations would transfer collected wastewater to a

new wastewater treatment facility within the study area. The wastewater treatment plant, storage pond, and irrigation area sizing would be the same as in Alternative 2.

5.2 ESTIMATED COSTS OF ALTERNATIVES

5.2.1 Estimated Construction Costs

Costs for construction of the various system alternatives scenarios were estimated using cost data from recent similar wastewater projects. For this feasibility study, project construction costs were estimated without detailed survey or testing information and should be viewed as preliminary. Collection systems, treatment facility and storage costs were based on full implementation of the project for the 30 year planning horizon.

Preliminary cost estimates for the construction of each alternative are shown in Table 5-1. Alternative 3 proved to have the least expensive construction costs at \$23.3 million followed by Alternative 4 at \$29.6 million. These costs are reflected in year 2001 dollars and assume the alternative would be constructed as one project. A complete preliminary cost estimate for each alternative is presented in Appendix A.

5.2.2 Estimated Operation and Maintenance Costs

Annual costs for the operation and maintenance of the proposed collection systems and treatment plants were developed for each alternative. The methodology for determination of these costs included the following assumptions:

1. Collection system maintenance assumed to be \$5,000 per year per mile of sewer pipe (6-inch diameter or greater).
2. Lift station annual cost assumed to be \$5,000 labor per lift station per year, plus \$2,000 equipment

and materials per lift station per year, plus pumping costs based on horsepower requirements, 60 percent efficiency, operation rate of 25 percent on/75 percent off for 2031 peak flows, and electrical cost of \$0.08 per kilowatt-hour.

3. Treatment plant operation and maintenance costs estimated from general relationship as function of plant flow rate developed from engineering references (*Wastewater Treatment Plants: Planning, Design, and Operation*, Qasim, 1999).

Annual operation and maintenance costs are displayed in Table 5-2. The highest operation and maintenance cost is projected for Alternative 2, while the lowest is projected for Alternative 4.

The annual operation and maintenance costs were then combined with the annual debt service for the project construction cost to determine a total annual cost. Construction costs were annualized assuming a 20 year simple interest loan using a 6% rate compounded monthly. Table 5-3 summarizes estimated total annual costs. The lowest total annual cost is projected for Alternative 3, the pressure sewer system connecting to the TBRSS scenario.

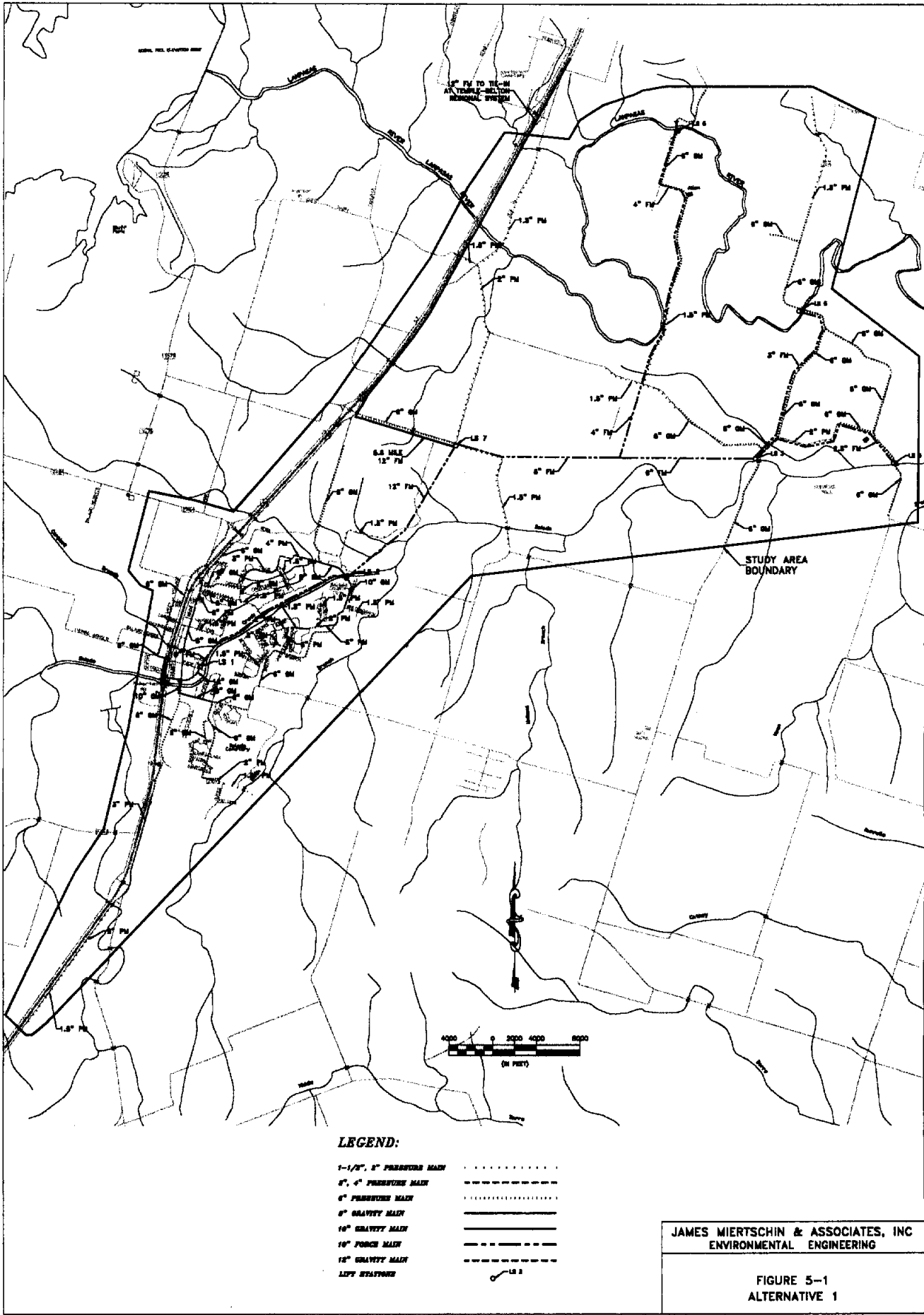

LEGEND:

- 1-1/2", 2" PRESSURE MAIN (dotted line)
- 2", 4" PRESSURE MAIN - - - - - (dashed line)
- 6" PRESSURE MAIN (dash-dot line)
- 6" GRAVITY MAIN _____ (solid line)
- 16" GRAVITY MAIN _____ (thick solid line)
- 18" FORCE MAIN - - - - - (long dashed line)
- 18" GRAVITY MAIN - - - - - (short dashed line)
- 1575 STATION (hook symbol)



JAMES MIERTSCHIN & ASSOCIATES, INC
ENVIRONMENTAL ENGINEERING

FIGURE 5-1
ALTERNATIVE 1

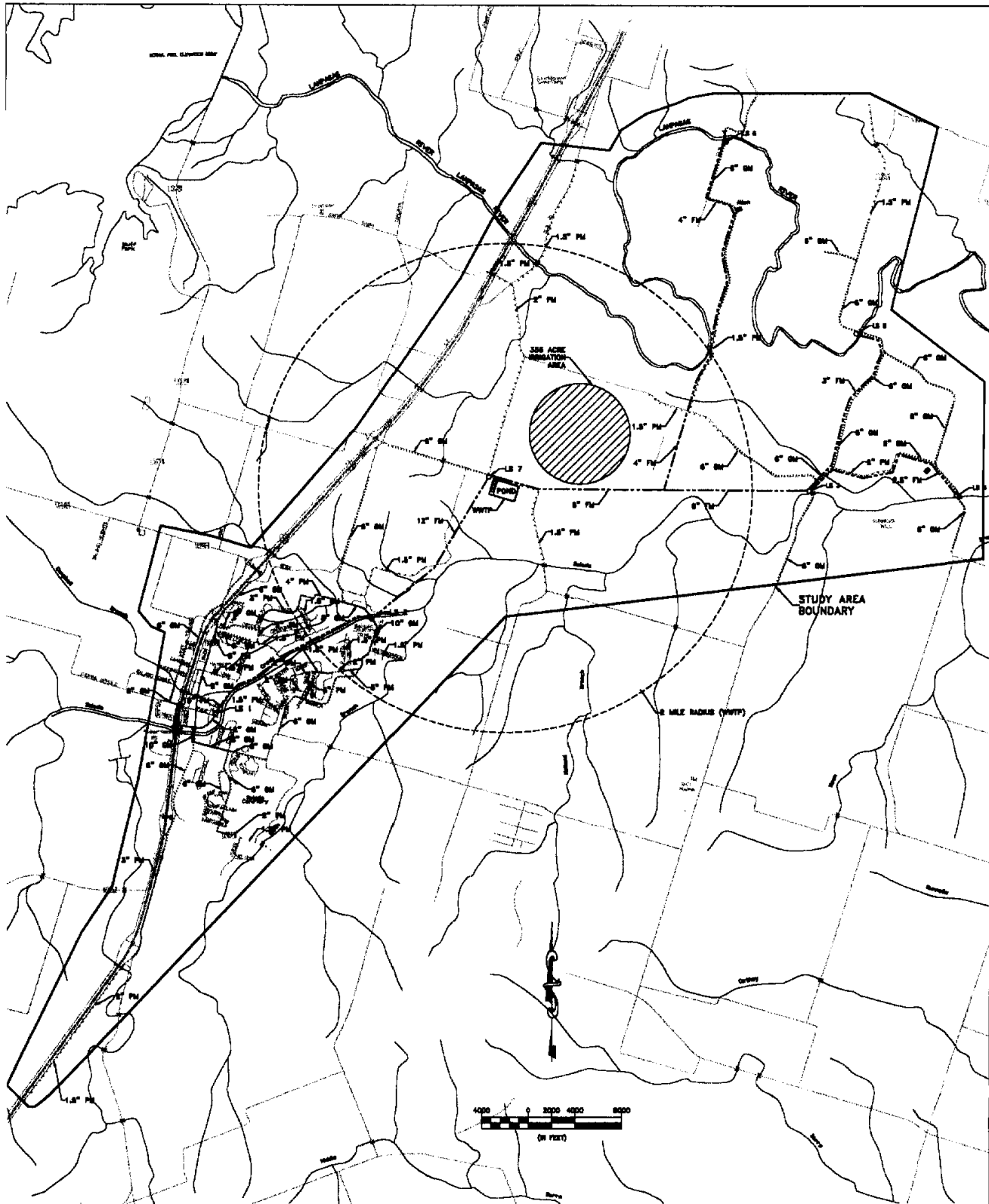

LEGEND:

- 1-1/2", 2" PRESSURE MAIN (dotted line)
- 4", 6" PRESSURE MAIN ----- (dashed line)
- 6" GRAVITY MAIN (dash-dot line)
- 8" GRAVITY MAIN ----- (solid line)
- 10" GRAVITY MAIN ----- (solid line)
- 12" FORCE MAIN ----- (solid line)
- 18" GRAVITY MAIN ----- (dashed line)
- LEFT STATIONS ↖ (arrow symbol)

JAMES MIERTSCHIN & ASSOCIATES, INC
 ENVIRONMENTAL ENGINEERING

FIGURE 5-2
 ALTERNATIVE 2

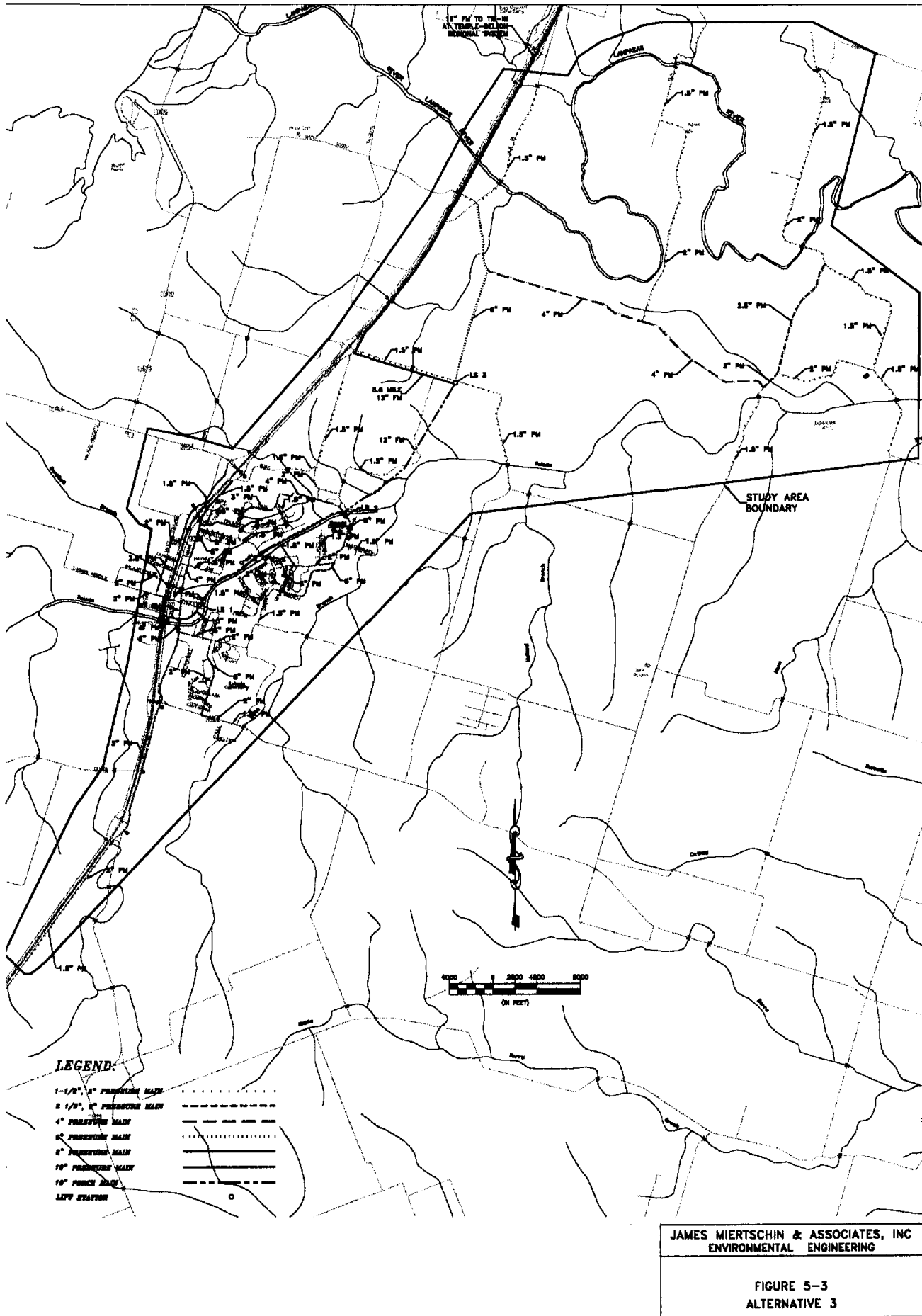

JAMES MIERTSCHIN & ASSOCIATES, INC
 ENVIRONMENTAL ENGINEERING

FIGURE 5-3
 ALTERNATIVE 3

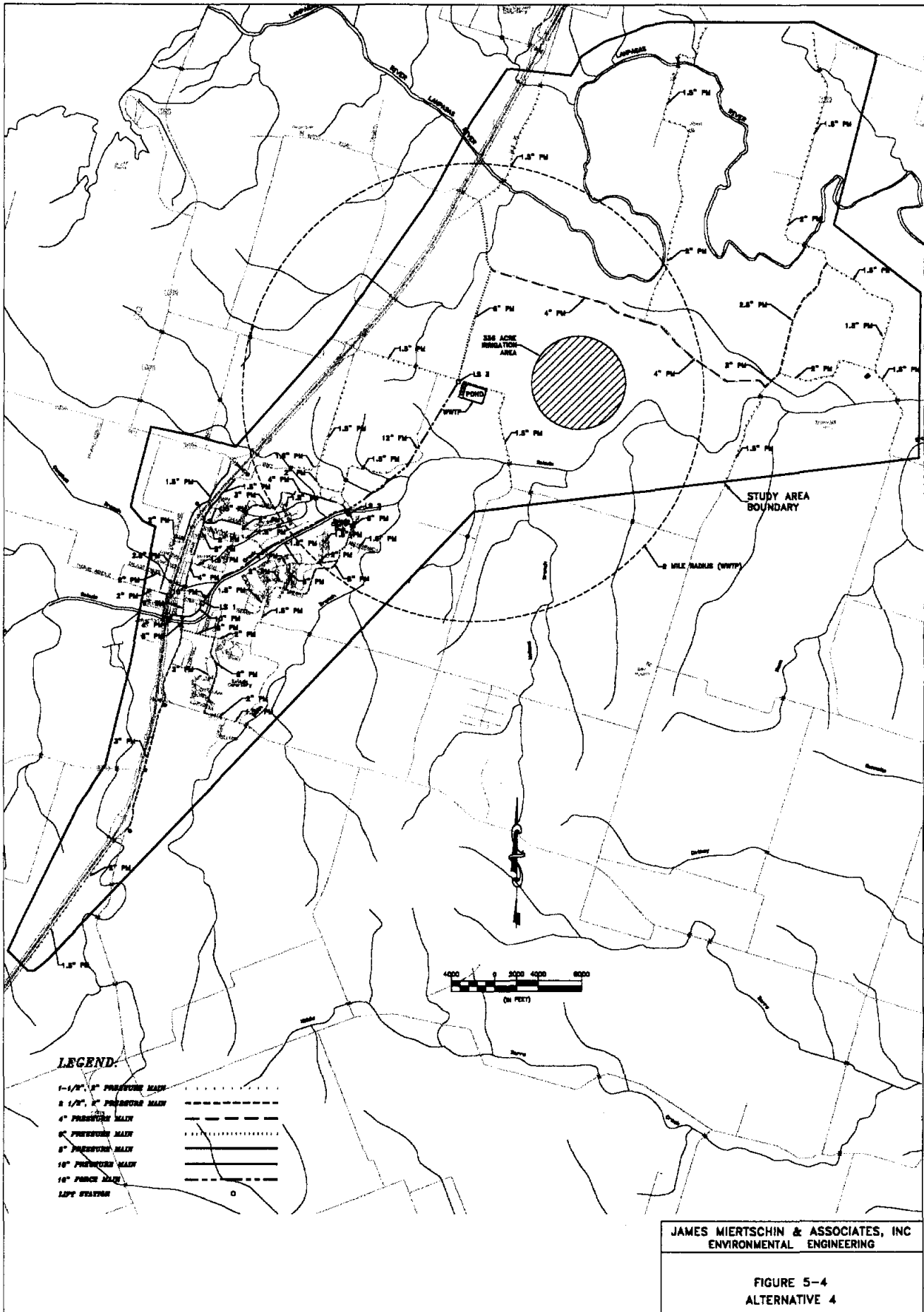

Table 5-1
Preliminary Construction Cost Estimates

Item	Alternative 1	Alternative 2	Alternative 3	Alternative 4
Construction Costs	\$24,292,850	\$28,953,900	\$14,937,450	\$19,598,500
Contingencies and Fees	\$13,603,996	\$16,214,184	\$8,364,972	\$10,975,160
Total Capital Costs	\$37,896,846	\$45,168,084	\$23,302,422	\$30,573,660

Table 5-2
Projected Annual Operation and Maintenance Costs

Item	Alternative 1	Alternative 2	Alternative 3	Alternative 4
Collection System	\$205,114	\$178,182	\$64,583	\$37,652
Lift Stations	\$205,216	\$165,541	\$128,203	\$88,528
Treatment Plant	\$195,150	\$195,150	\$195,150	\$195,150
Total O&M	\$605,480	\$538,873	\$387,936	\$321,330

Table 5-3
Estimated Total Annual Costs

Item	Alternative 1	Alternative 2	Alternative 3	Alternative 4
Debt Service for Capital Cost	3,258,057	3,883,178	2,003,349	2,628,470
O&M Cost	605,480	538,873	387,936	321,330
Total Annual Cost	3,863,537	4,422,051	2,391,286	2,949,800

6.0 ENVIRONMENTAL IMPACTS

6.1 STUDY AREA

Salado Creek has historically served as a key feature and amenity for the populace of the Village of Salado. The Salado Creek watershed encompasses 170 square miles along a southwest-to-northeast axis, with most of the area positioned west of IH-35. Flow in the creek near the Village is sustained by local spring flow.

The area surrounding the Village of Salado is located on the outcrop of the Del Rio formation, which is a confining unit for the northern segment of the Edwards Aquifer. The main water bearing formations include the Georgetown, Edwards, and Comanche Peak formations. Salado Creek receives flow from runoff and from baseflow contributed by the underlying aquifer. The springs in the vicinity of the Village emerge through faults in the limestone, and include Robertson, Big Boiling, Elm, and Anderson springs. The area immediately surrounding the Village is not situated within the recharge zone of the Edwards Aquifer, according to mapping available from the TNRCC. Past water quality studies in the area have noted the presence of sinkholes in a tributary channel upstream of IH-35.

Residential and commercial wastewater service in the study area is provided by onsite septic tank and drainfield disposal systems. Only one local business, the Stagecoach Inn, does not utilize a septic system. The Stagecoach Inn has a wastewater treatment plant permitted by the TNRCC. The facility is authorized by permit to discharge up to 0.1 MGD of treated wastewater effluent directly to Salado Creek, and this method was employed for some time in the past. However, the facility routinely pumps its treated effluent to a site for use in irrigation of Bermuda pasture under a reclaimed water use permit.

The onsite disposal systems in the area surrounding the Village of Salado have been identified in past studies as potential and likely contributors to observed water quality problems in Salado Creek. Soils

in the study area have been mapped by the Soil Conservation Service. Soils were classified as to limitations for absorption of septic tank effluent. Limitations are perceived if percolation is too slow or too rapid, or if an area has steep slopes or routinely floods. Area soils are predominantly rated as severely limited for the use of soil absorption drainfields.

6.2 "DO NOTHING" ALTERNATIVE

The "do nothing" alternative for the study area would involve continuation of reliance upon individual onsite septic systems for wastewater treatment and disposal. The area around the Village of Salado is experiencing increasing developmental pressure, and residential population and business expansion will increase over time.

With the documented limitations of area soils for use with onsite disposal systems, an increase in the number of systems will probably increase the potential for resultant water quality problems. If septic systems have in fact been the primary source of the historical observations of elevated fecal coliform levels in the stream, an increase in systems will likely result in increases in observed fecal coliform levels, or, continuation of elevated levels. This potential may be offset to a certain extent by application of more stringent design and construction standards for onsite systems in the area.

Problems may also occur with the feasibility of future replacements of existing septic systems. As design and construction standards have been updated, it is possible that some onsite systems will encounter limitations on available land space for system replacement if the need arises.

6.3 CENTRALIZED WASTEWATER SYSTEM

The present study examines the feasibility of implementation of a centralized wastewater system to serve residential and business customers in the study area. There are alternatives for the layout of the collection system and alternatives for the approach to the treatment aspect. Collection system alternatives include a gravity-type system and a pressure-type system. Wastewater treatment

approaches include construction of a treatment plant, storage pond, and irrigation disposal system, and the alternative of connection to the BRA Temple-Belton regional treatment plant.

The potential environmental impacts of the proposed centralized wastewater approaches are similar. Provision of centralized collection, whether by gravity or by pressure pipes, will substantially reduce the number of septic tank and drainfield disposal systems in operation in the study area. This, in turn, would substantially reduce the potential contributions from onsite systems to observed water quality problems in Salado Creek.

Installation of a centralized collection system will entail placement of pipes underground to convey raw sewage away from residences and businesses. There is theoretically some amount of infiltration or exfiltration associated with underground piping. For the gravity pipelines, the most common concern is usually infiltration of groundwater into pipe joints, with subsequent conveyance to the treatment facility. Exfiltration is also possible, but seepage amounts are expected to be low. The TNRCC has guidelines for allowable exfiltration from buried sewage pipes. The quantity varies according to the diameter of the pipe, but allowable amounts are nominally on the order of 50 gallons per inch diameter per day per mile of pipe and 10 gallons per inch diameter per day per mile for construction within the 25 year flood plain.

Similarly, guidelines exist for the allowable leakage from pressure pipelines. Pressure pipelines are typically smaller diameter PVC pipes, and the maximum allowable leakage is calculated using the formula below.

$$L = (S * D * (P)^{0.5}) / 133,200$$

where: L = leakage in gal/hr
 S = length of pipe
 D = inside diameter of pipe in inches
 P = pressure in pounds per square inch

While these numbers for allowable exfiltration may appear large, they are small relative to the quantity of wastewater that is released directly into the soil from the totality of onsite septic drainfield systems in the study area.

The preceding numbers reference typical collection system construction. Additional measures could be implemented within the Salado study area in order to reduce the potential for impacts from the collection system upon area seeps and springs. For example, more stringent construction standards are in place for systems located on the Edwards Aquifer contributing zone (note that study area is not located in the contributing zone). The additional requirements to be considered in the design of sewer systems in the Edwards Aquifer area are described in the Texas Natural Resource Conservation Commission's Rules, Section 213, Edwards Aquifer. A summary of these requirements are listed below:

1. Manholes must be watertight, with watertight rings and covers. Testing is required.
2. For gravity collection systems, PVC pipe must have a diameter greater than or equal to 6 inches, and must have an SDR rating of 35 or less.
3. For pressurized collection systems, PVC pipe must have a working pressure of 150 psi or greater.
4. Lift stations must be designed and constructed such that there is no bypassing of sewage.
5. Owners of collection system must ensure that all sewer lines greater than or equal to 6 inches in diameter are tested to determine types and locations of structural damage or defects. Tests must be conducted every 5 years. Determined defects must be corrected within 1 year.
6. New collection system lines must be constructed with stub outs for the connection of anticipated connections (must be clearly marked on ground).
7. New sewer lines cannot be located within a 5-year floodplain.

Construction of a local wastewater treatment plant, storage pond, and irrigation system would not

be expected to have any negative impact on area seeps, springs, or surface water quality. The treatment plant would be constructed of steel or concrete, and would not be expected to leak. The effluent storage pond would be equipped with a clay or synthetic liner material to minimize seepage. Effluent would be applied for irrigation of a cover crop, typically Bermuda grass, at a rate commensurate with the crop water needs, such that the effluent would be disposed of predominantly by plant evapotranspiration. Any effluent that could, however unlikely, potentially migrate to groundwater resources would be highly treated, compared to septic tank effluent. Therefore, implementation of this alternative is not expected to have any negative impacts on water quality. This method of disposal presents much less likelihood of impact than reliance upon individual onsite septic systems in the study area.

The alternative of connection to the regional BRA Temple-Belton treatment system represents similar avoidance of negative impacts in the study area. It also represents significant improvement over the existing septic system approach.

7.0 INSTITUTIONAL AND FINANCING OPTIONS

7.1 OPERATIONAL SCENARIOS

There are alternatives for wastewater system operation. The collection system and treatment system could be constructed and operated as a stand-alone, individual facility as one alternative. Another alternative would be for the collection system and treatment system to be constructed and operated as a component of a larger regional system. A third alternative would be to construct a collection system to serve the study area and tie into the existing regional treatment system operated by the BRA.

Operation as a stand-alone facility has the benefit of a high degree of local control, such that the administration and operation can be tailored to the desires of the local customers. However, the stand-alone concept also requires a significant investment in time for a governing board of directors and an investment in permanent administrative and operational staff for the facility.

Operation of the facility as a component of a larger regional system retains some measure of local control. It has the advantage of participation of a larger regional administrative and operational staff resource.

Operation as an integral component of a larger regional system has the advantage of reliance on an existing administrative and operational staff. There should also be cost savings associated with a larger scale operation.

7.2 OPERATOR TYPES

A water district is a local, governmental entity that provides limited services to its customers. Through "general law," a district may be created by the TNRCC or the county commissioners court. "Special districts" have been either created by or altered by an act of the Texas Legislature.

TNRCC has the right to supervise districts through the Texas Water Code, but TNRCC does not control the daily operations of a district. Districts must also comply with applicable state and federal regulations for certain operations, such as wastewater discharge requirements.

“General law” districts must follow Water Code Chapters 49 through 66. These laws describe the powers and duties of each type of district and give administrative rules that districts must follow.

Districts must also comply with other laws, including the Election Code, Government Code, Health and Safety Code, Penal Code, and Tax Code. A “special law” district must comply with its enabling legislation, in addition to other laws.

The four most common types of districts that provide water and wastewater services in Texas are municipal utility districts (MUDs), water control and improvement districts (WCIDs), special utility districts (SUDs), and river authorities.

MUDs can provide a variety of services, including water supply and treatment, wastewater collection and treatment, conservation, irrigation, drainage, solid waste collection, and fire fighting.

WCIDs have broad authority to supply water for domestic, commercial, and industrial use, to provide wastewater collection and treatment, and provide irrigation, drainage, and water quality services.

SUDs can provide water, wastewater, and fire-fighting services. They cannot levy taxes.

River authorities are “special law” districts that can have responsibility for water supply, water treatment, wastewater treatment, power supply, and flood control. River authorities can serve as a wholesale provider or retail provider of services. Most river authorities cannot levy taxes, but they can issue bonds based on projected revenues.

Many districts can issue bonds and other forms of debt. Tax-supported bonds must be approved by district voters. The TNRCC must approve most district bonds.

Districts, except for river authorities and SUD's, have the power to levy taxes. A maintenance tax is generally levied to cover the costs of operation and maintenance of a water or wastewater utility. A maintenance tax rate authorized by voters requires additional voter approval to be raised.

Districts may also utilize unlimited tax bonds, with voter approval. An unlimited debt service tax is thereby authorized for bond payment. The district must levy an annual property tax sufficient to cover the outstanding debt.

Districts can obtain easements for installation, inspection, repair, and maintenance of utility lines. Most districts have the right of eminent domain, and they can condemn property inside or outside the district boundaries when the need exists.

Utility rates charged by a district are supposed to reflect the true cost of providing the service. TNRCC does not review rates unless customers appeal a rate change. Districts can charge a standby fee, which is a charge other than a tax imposed on undeveloped property, where utility service is available. TNRCC permission is required to assess standby fees.

7.3 EXISTING ENTITIES

There are existing entities that could potentially serve as a regional wastewater collection and treatment system operator. The most likely include the Village of Salado, the BRA, and the Salado Water Supply Corporation.

The Village of Salado could serve as a wastewater system operator. The Village could generate revenue from property taxes or rates. They would have to acquire a nucleus of administrative and maintenance staff, or, this function could be contracted out to a private service provider. Benefits

of the Village as operator include a high degree of local control and the ability to locally determine the time frame and extent of service.

The BRA could readily serve as a regional operator. The river authority already serves in this capacity for the nearby Temple-Belton Regional Wastewater Treatment Plant. They have a full complement of administrative, operations, and maintenance personnel currently engaged in this type of activity. BRA could generate revenue for system operation via rates. The benefits associated with operation by BRA include existence of an established operational team and familiarity with the nuances of a regional-type system. BRA typically serves as a wholesale provider of service, which requires another entity to serve as the retail provider, with responsibility for billing. It is possible, however, that BRA could also provide retail service.

The Salado Water Supply Corporation could serve as a regional provider. They currently have administrative and operational staff for providing potable water service in the area. The WSC has a board of directors elected by the system member or users. The water supply corporation could also assume responsibility for wastewater service. The WSC derives revenue from utility rates. Benefits of the WSC as regional operator include a high degree of local control and the existence of a nucleus of administrative and operational personnel. Billing may also be simplified, since a large portion of the study area already receives potable water service and a monthly bill from the WSC. In one possible scenario, the WSC could be the retail provider of wastewater service, and contract with the BRA for wholesale service.

7.4 FUNDING OPTIONS

There are several major sources of financing for wastewater projects, including the following:

1. Open market bonds
2. Texas Water Development Board programs

3. United States Department of Agriculture (USDA) programs
4. Grant programs

A general summary of funding options is provided in Table 7-1.

7.4.1 Open Market Bonds

Public agencies have the ability to borrow funds in the financial markets through the issuance of bonds, then use the proceeds to construct public water supply and wastewater projects, including water wells, pipelines, water treatment plants, sewage treatment plants, collection systems, pump stations, storage tanks, and associated capital equipment. The bond holders would be repaid with interest from revenues and/or fees collected from those who receive water and sewer services. In cases where public entities issue bonds to supply water and/or wastewater services to the public, the bonds are classified under federal laws as “tax exempt.” On tax exempt bonds, the interest paid to the bondholders is not considered as ordinary income; therefore the bondholder does not have to pay income tax on the earnings from those investments. As a result, individuals and other investors are willing to lend their capital to governmental entities at lower interest rates than would be the case if the interest on those loans (bonds) were taxed by the federal government.

There are three categories of municipal bonds:

- General Obligation Bonds
- Revenue Bonds (No Tax, System Revenues ONLY)
- Certificates of Obligation (Combination Tax and Revenue)

General Obligation Bonds are normally not used for wastewater improvements. These bonds are normally paid strictly from tax revenues and require an election of the general population for approval. General Obligation Bonds are considered the most secure form of debt instrument for an investor. The bonds are backed by an unlimited tax pledge against all taxable property in the City.

Revenue Bonds are often used for wastewater improvements. These bonds can normally be approved by a vote of a City Council. Most cities can issue Revenue Bonds without an election, unless one is required by charter provisions. Revenue Bonds are not considered as secure an investment as General Obligation Bonds. Additional security is often required from a City. A reserve fund or deposit in a special account in the amount of one year's payment is often required. Normally, a "coverage" factor is also required. A "coverage" factor is a revenue and income stream with "excess" revenue above the known requirements and is expressed as a ratio of the debt service (principal and interest). A common requirement is a 1.25 coverage. A 1.25 coverage would have wastewater revenues (rates) sufficient to pay all of the requirements, including debt service, and would have enough "extra" equal to 25% of one year's debt service.

Certificates of Obligation, sometimes called Combination Bonds, can be paid from either taxes or revenue. This type of bond has become popular in Texas during the last twenty years. These bonds can be approved by the City Council and an election is required only if a sufficient protest by petition is received during the comment period. These bonds are normally paid with revenues. If revenues are inadequate, payment by taxation can be required. No reserve fund or coverage is normally required. Because of the dual pledge, these bonds often carry a higher rating and therefore lower interest rates than a comparable revenue backed bond. The tax pledge is a "back-up" or standby pledge that is only invoked should revenues be insufficient to repay the bonds.

7.4.2 Texas Water Development Board Programs

The TWDB has an array of financial assistance programs, but only three are generally applicable to the financing of a regional wastewater system.

7.4.2.1 Clean Water State Revolving Fund (CW-SRF)

The CW-SRF was established in 1987 to provide a financing source for wastewater treatment and non-point source pollution control projects. The SRF provides below market interest loans to eligible

political subdivisions for construction, improvement, or expansion of sewage collection and treatment facilities. The SRF is funded through a combination of federal clean water grants and state water quality enhancement bond funds. In order to be eligible for SRF financing, an applicant must be a political entity with the authority to own and operate a sewage system, for example, a municipality or a municipal utility district.

Nonprofit water supply corporations are not eligible to receive assistance from the SRF program. Funds are available for financing all eligible projects on a first-come, first-served basis; generally, applicants can finance their capital improvement plans with SRF funds.

Loans can be used for the planning, design, and construction of sewage treatment facilities, wastewater recycling and reuse facilities, collection systems, stormwater pollution control projects, and nonpoint source pollution control projects.

The SRF offers two choices of loan terms for borrowers: (1) a traditional long-term, fixed-rate loan at the beginning of construction; or (2) a short-term, variable-rate construction period loan that converts to a long-term, fixed-rate loan within 90 days of the completion of construction. Borrowers also have an option to convert to long-term, fixed-rate financing at any time prior to project completion. With either option, the borrower will receive a long-term interest rate that is 0.7 percent below the rate the borrower would receive on the open market at the time of closing. The short-term, variable interest rate will generally be about 2.5 percent below long-term market rates in effect at the time. The maximum repayment period for a SRF loan is 20 years from the completion of construction.

Rule changes approved in 1995 offer an additional interest rate reduction to offset new loan origination and servicing charges. These charges were authorized by the Texas Legislature as a cost-recover means for replacing federal grants previously available to fund the administrative costs of operating the SRF loan program.

The TWDB is offering SRF loan customers two options for the cost recovery charges. Option 1 assesses a 2.25 percent loan origination charge calculated on the SRF loan amount, not including the amount of the loan origination charge. To offset the charge, the Board is offering an additional 0.30 percent reduction in lending rate to customers choosing Option 1. (Total long-term interest rate subsidy is 1.0 percent.)

Option 2 assesses a lower origination charge plus an annual servicing charge. In addition to a 1.65 percent loan origination charge, the borrower pays an annual servicing charge of 0.15 percent of the SRF loan amount, not including the amount of the loan origination charge. The servicing charge is due and payable on the annual interest-only payment date. Under this option, the Board is offering borrowers an additional 0.48 percent reduction in lending rate to offset the loan origination and annual servicing charges. (Total long-term interest rate subsidy is 1.18 percent.)

Because interest rate subsidies are being offered to offset the cost-recovery charges, total debt repayments will be virtually unchanged for borrowers choosing either option.

Prospective applicants are asked to submit a brief SRF Information Form to the Board prior to July 1 of each year for inclusion in an Intended Use Plan (IUP) developed for that year. The Information Form describes the applicant's existing sewage facilities, additional facility needs and the nature of the projects being considered for meeting those needs, and project cost estimates.

Prospective applicants are encouraged to schedule a pre-planning conference with Board staff for guidance in preparing the engineering, planning, environmental, and water conservation portions of the SRF application.

Initially, the applicant must submit an engineering feasibility report and environmental assessment to Board Engineering staff. Following approval of these documents, general, fiscal, and legal application information must be submitted to the Development Funds Division for staff review on the first business day of the month preceding the month during which the applicant desires Board

consideration. At the request of the applicant, a meeting with the Development Fund Division staff may be held to assist in the preparation of the application and to discuss the terms of the loan.

Completed applications for SRF loans are considered by the Board during monthly meetings, at which time the Board may commit to fund the project.

Using the Board's pre-design funding option, an eligible applicant could receive a Board commitment based on preliminary engineering information. Shortly thereafter, the Board closes the loan. Funds for completing detailed planning, including environmental studies, are provided at closing, while funds for design, preparation of final plans and specifications, and construction are placed in escrow until needed. The interest rate is locked in at closing. Approved applications typically receive a two-year commitment. The applicant's ability to repay the loan is a major determining factor in the approval for using the pre-design funding option.

If the pre-design option is not used, the applicant must develop plans and specifications and have them approved, obtain all necessary permits, and open bids prior to closing the loan.

Once the SRF applicant has awarded the construction contract to the low bidder, the applicant submits copies of the executed construction contract and final bond ordinance or resolution to the Board for review and approval.

The applicant's bond council arranges for the approval of the debt by the Attorney General's office and the financial adviser schedules a closing date for the exchange of debt for loan money.

The applicant and Board staff monitor the project during the construction process.

Loans are monitored by Board staff for the life of the outstanding debt to ensure compliance with the bond indenture requirements and sound financial condition.

Applicants for loans greater than \$500,000 must adopt a water conservation plan (statutory requirement).

7.4.2.2 State Participation Fund

The concept of State Participation, as it applies to water supply and water quality protection projects, is as follows. A local area needs an additional water source, transmission pipelines, storage reservoir, and treatment plant, or has wastewater collection and treatment plant needs. The area's existing customer base can only support monthly rates required to repay loans for a project sized to meet present needs. However, if a project is built to only meet present needs, it may soon be inadequate. Thus, through the State Participation Fund, the local entity could plan a larger project, with phased construction of the separate elements to the extent possible, and apply to the TWDB for state participation in the project. Under this arrangement, the TWDB would become a "silent partner" in the project by entering into an agreement with the local entity to pay up to 100% of the project costs initially. The TWDB would hold their project share until a future date, at which time the local entity would be required to buy the TWDB's share.

The terms and conditions of such an agreement are negotiated for each case. Typically, the local entities are required to pay simple interest on the TWDB's share of the project cost from the beginning and to begin buying the TWDB's share, including accumulated interest, at a specified future date, usually within 8 to 12 years of project completion. By lending the state's credit to local areas, an optimal longer-term development plan for growing areas can usually be implemented at lower costs. However, the recipient of the loan will be required to repay the TWDB, including interest and financing costs incurred.

It should be emphasized, however, that the State Participation Fund is appropriate and reasonable only for additional project capacities (oversizing). Also, the relative attractiveness of the State Participation Fund increases if: (1) the oversizing is typically carried by the State for a longer period

of time (10 or more years), and/or (2) there is a higher degree of uncertainty if major customers will utilize this excess capacity in the near-to-medium term.

7.4.2.3 Texas Water Development Fund (D-Fund)

The TWDB has authority granted by Texas Constitutional Amendments and state statutes to issue State of Texas General Obligation Bonds to provide loans to political subdivisions and special purpose districts for the construction of water supply, sewer, and flood control projects under the auspices of the Texas Water Development Fund.

The TWDB uses the proceeds of its bond sales to purchase the bonds (either general obligation or revenue) of cities and local water districts and authorities, which in turn use the borrowed funds to pay for construction of local projects. The local district or city repays the TWDB, with interest equal to the rate that the TWDB must pay on its bonds plus 0.5 percent, which the TWDB uses to retire the bonds it issued. The 0.5 percent assists the state in repaying the cost of administering the loan program. However, the interest rate on TWDB bonds is specific to each TWDB bond sale and therefore varies as market conditions change.

The State of Texas water resources loan program enables some cities and local districts, especially smaller entities that do not have a credit rating or sufficient credit rating, to utilize the credit of the State in financing project and thereby obtain financing at lower interest rates than if they were to sell their bonds on the open bond market.

7.4.3 United States Department of Agriculture Programs

Through the USDA's Texas Rural Development Agency, direct loans may be made to develop water and wastewater systems, including solid waste disposal and storm drainage, in rural areas and to cities and towns with a population of 10,000 or less. Funds are available to public entities, such as municipalities, counties, special-purpose districts, and Indian tribes. In addition, funds may be made

available to corporations operated on a not-for-profit basis. Priority will be given to public entities, in areas with less than 5,500 people, to restore a deteriorating water supply, or to improve, enlarge, or modify a water facility or an inadequate waste facility. Also, preference will be given to requests which involve the merging of small facilities and those serving low-income communities. Applicants must be unable to obtain funds from other sources at reasonable terms and rates. The maximum term for all loans is 40 years; however, no repayment period will exceed State statutes or the useful life of the facility. Interest rates may be obtained from Rural Development field offices.

7.4.4 Grant Programs

For the most part, federal financing assistance for wastewater is made through the federal grant contribution to the state revolving loan programs, which provides for the below-market interest rates on the program's loans. It is possible that other sources of federal grant funds may be available to address the wastewater infrastructure need if certain eligibility criteria are met and the allocated funds are not designated for other community priorities.

7.4.4.1 USDA Grants

The USDA Rural Development Agency offers grant funding in addition to loans. Grants may be made, in some instances, up to 75 percent of eligible project costs.

Eligible applicants include public entities such as municipalities, counties, special purpose districts, Indian tribes, and corporations not operated for profit. The rural area to be served must have:

- (1) A per capita income of the residents not more than 70 percent of the most recent national average per capita income, as determined by the department of Commerce; and
- (2) An unemployment rate of the residents not less than 125 percent of the most recent national average unemployment rate, as determined by the Bureau of Labor Statistics.

Residents of the rural area to be served must face significant health risks due to the fact that a significant proportion of the community's residents do not have access to, or are not served by, adequate, affordable water and/or waste disposal programs.

In general, grant funds may be used to:

- (1) Construct, enlarge, extend, or otherwise improve community water and/or waste disposal systems. Other improvements include extending service lines to and/or connecting residence's plumbing to the system.
- (2) Make loans and grants to individuals for extending service lines and/or connecting residences to the applicant's system.

Loan forms to cities are in the form of municipal bonds. These bonds are often certificates of obligation (combination revenue and tax bonds).

Grant funds are extremely limited. A large waiting list exists for the grant funds. Any project expecting grant funds can expect to consume several years effort with no guarantee of success.

7.4.4.2 Texas Community Development Program Grants

The goal of the Texas Community Development Program is the development of viable communities by providing decent housing and a suitable living environment and by expanding economic opportunities, principally for persons of low and moderate income.

The objectives of the Texas Community Development Program include:

- (1) To improve public facilities to meet basic human needs, principally for low and moderate income persons.

- (2) To provide assistance and public facilities to eliminate conditions hazardous to the public health and of an emergency nature.

Eligible applicant are non-entitlement "units of general local government", incorporated cities and counties, which are not participating or designated as eligible to participate in the entitlement portion of the federal Community Development Block Grant Program. Non-entitlement cities that are not participating in urban county programs through existing participation agreements are eligible applicants.

While non-entitlement units of general local government are the only eligible applicants for TCDP funding, these applicants can choose to submit applications that will provide benefits through other subrecipient groups serving the jurisdiction.

All proposed activities must meet at least one of the three national programs objectives:

- (1) Principally benefit low and moderate income persons. (At least fifty-one percent (51%) of the identified beneficiaries must have an income of less than 80% of the area median family income.)
- (2) Aid in the prevention or elimination of slum or blighted areas.
- (3) Meet other community development needs of particular urgency which represent an immediate threat to the health and safety of residents of the community.

The complete descriptions of eligible activities under the Texas Community Development Program are located in Section 105(a) of the Federal Housing and Community Development Act of 1974, as amended. These include:

- (1) The acquisition, construction, reconstruction, or installation of public facilities such as

water facilities, sewer facilities, street improvements, drainage/flood control improvements, solid waste disposal facilities, community or senior citizens' centers and other publicly-owned utilities.

(2) The acquisition of real property to be used for the provision of eligible TCDP activities.

The primary beneficiaries of the Texas Community Development Program are low to moderate income persons. Low to moderate income families are those earning less than 80 percent of the area median family income figure (where the area is a metropolitan statistical area or a non-metropolitan county) or less than 80 percent of the statewide non-metropolitan median family income figure, as defined under the HUD Section 8 Housing Assistance Program.

The maximum amount of grant funds available through the Texas Community Development Program is \$250,000 per application. The applications are competitive under a complex scoring system. "First-time sewer" normally receives a very high score.

No loan or bond funds are available through this program. Matching funds are required, the larger the match (normally) the higher the rating. Matching funds must be secured elsewhere.

**Table 7-1
Summary of Funding Options**

Option	Availability for Wastewater Collection and Treatment	Amount Available	Current Interest Rate	Time Frame for Funding
Open Market Bonds	yes	as needed	4.50-5.30%	3-4 months
Texas Water Development State Revolving Fund	yes	as needed	4.00%	5-6 months
U.S. Department of Agriculture Rural Development Agency - Loans	yes	as needed	4.50-5.00%	8-12 months
U.S. Department of Agriculture Rural Development Agency - Grants	yes	as eligible	N/A	2-4 years
Texas Community Development Program	yes	\$250,000	N/A	2-4 years

8.0 NEW SYSTEM IMPLEMENTATION

There were several alternatives evaluated for collection and treatment system scenarios for this study. Alternative 3, consisting of a pressure sewer system and tie-in to the TBRSS treatment plant, was the projected lowest cost alternative and is recommended for implementation. The projected construction and operational costs are large, and their magnitude can represent a formidable barrier to implementation. While a large sponsor could potentially implement the entire study area system, it would be generally prudent to phase the construction of the system in order to provide more economical treatment. Construction in phases would enable a smaller sponsoring entity to pursue the project. Therefore, a phased approach to implementation of the regional system was evaluated for the recommended alternative, as described below.

8.1 PHASED APPROACH TO IMPLEMENTATION

There are multiple phasing combinations for the study area that could be considered. The Central Business District appears to present a logical opportunity for phasing the proposed wastewater system. However, after review of preliminary cost estimates and public meeting comments, it was determined that a more highly developed area smaller in extent than the Central Business District should be considered as an initial phase.

Therefore, an initial phase of the project was delineated that would include a more dense, centralized area called the "Core Business District" for this study's purpose. It would include many of the existing businesses located in the Central Business District, as well as multiple residences and the Salado school system. This phase would serve to provide initial construction of a wastewater collection and treatment facility and begin the effort to discontinue reliance on onsite septic systems. Sizing of collection and transmission facilities were based on flows calculated for serving the entire Central Business District. This will allow for expansion capabilities while minimizing expansion costs, and the associated nuisance, for replacing sewer pipe under roadways. Figure 8-1 shows the proposed Core Business District's boundary.

As interest in connecting to the wastewater system increases, the system could be expanded to include the entire Central Business District. This second phase would expand the wastewater services to include all of the businesses, residences and schools located within the Central Business District and would significantly reduce the number of onsite septic systems. This phase would also include potential expansion of wastewater service to the TXDOT rest areas located on IH-35.

Alternatively, the initial phase could just as easily address the entire Central Business District, if the potential participants in the study area wish to move forward. The concept of the Core Business District was developed to provide a smaller first phase, but it is not mandatory.

Once these first two phases are in operation, future growth could dictate the development of the complete study area system. Therefore, coverage of the large geographical extent of the study area would be designed in response to actual development patterns that occur over a much longer time frame. This would be expected to provide more design efficiency for the more remote portions of the study area than that available in the present feasibility study

Projected wastewater flows for both potential phases are shown in Table 8-1.

8.1.1 Core Business District Initial Phase

The Core Business District pressurized collection system option would consist of the use of grinder pumps for liquefying raw sewage, pressurizing small diameter collection lines, and transferring wastewater to a proposed central lift station located in Page Park. Grinder pump units would be located at each wastewater connection. The lift station would transfer collected wastewater to the existing TBRSS facility (or conceivably, the initial phase could incorporate a small, new centralized treatment facility). Proposed layout of the pressure collection system alternatives for this scenario are shown in Figure 8-1.

8.1.2 Entire Business District Phase

This scenario would include a pressurized collection system to collect and transfer wastewater for the entire Central Business District. Grinder pumps and small diameter pressure lines would transfer wastewater to the proposed lift station located in Page Park. The proposed lift station could transfer collected wastewater to the existing TBRSS facility. Proposed layouts of the pressure collection system alternatives for this scenario are shown in Figure 8-2.

8.2 ESTIMATED COSTS FOR PHASED APPROACH

8.2.1 Estimated Construction Costs

Costs for construction of the phased system alternatives were estimated in a manner similar to the estimates for the complete study area alternatives.

Preliminary cost estimates for the construction of phased alternatives are shown in Table 8-2.

The preceding cost estimates are based on the assumption of full implementation of that phase. In other words, the cost for the Core Business District phase is a complete, stand-alone cost, and the cost for the Central Business District phase is a separate stand-alone cost for the entire Central Business District. With these two costs then, a system sponsor could select one for initial construction. Alternatively, the difference in cost between the two phases would approximately represent the differential cost required to implement the Central Business District phase after first implementing the Core Business District phase. A complete preliminary cost estimate for each alternative is presented in Appendix B.

8.2.2 Estimated Operation and Maintenance Costs

Annual costs for the operation and maintenance of the proposed phased alternatives were developed.

The methodology for determination of these costs included the same assumptions embraced in the cost analysis for the system-wide alternatives.

Annual operation and maintenance costs are displayed in Table 8-3.

The annual operation and maintenance costs were then combined with the annual debt service for the project construction cost to determine a total annual cost. Construction costs were annualized assuming a 20 year simple interest loan using a 6% rate compounded monthly. Table 8-4 summarizes estimated total annual costs for the two potential phases.

8.3 COST OF SERVICE

The potential monthly or quarterly sewer use charge to each connected customer within the study area may include several categories of charges depending on the organization of the sewer district.

These charges could include:

1. Principal and interest payments on municipal sewer revenue bonds.
2. Payment into reserve funds required in the trust indenture of the Sewer Revenue Bond Issue.
3. Operation and maintenance cost of the operating entity including administration, billing and accounting, labor and equipment, engineering and legal.
4. The prorated cost by the operating entity for treatment and transportation including their costs of items 1 through 3 above.
5. Capital recovery costs charged by the operating entity if the study area is connected to an existing treatment or transportation facility. This share of principal and interest cost of facility is from time of construction to time of connection. The theory behind this charge is that if the facility were constructed initially with excess capacity, and therefore extra costs, for future users then the future users should pay back the

original users for carrying the additional cost from time of construction to connection by future users. This is also applicable if the Central Business District were to be constructed in phases.

In order to arrive at an annual charge, the operating entity would add together all annual costs included in items 1 through 5 above and subtract from these costs any income derived from the system, such as interest earned by the bond reserve funds, permit or tap fees and internal capital recovery fees. The net cost is then divided by the number of living unit equivalents (LUE's) connected to their system to arrive at a uniform charge per LUE. The rate charged each connected customer is then dependent on the volume of water used as determined by water meter or by other recorded or mutually accepted negotiated rate.

A minimum bill rate per customer could be established by taking an estimated average wastewater volume per year usage of a single family residence, based on TNRCC recommended design criteria of approximately 300 gallons per day per residence. This volume amount is then used as the LUE. Most single family homes are routinely billed a single LUE. Commercial, institutional, and industrial customers could be billed by multiplying the business' square footage by their contributing category unit flow (see estimates listed in Table 5-3) and then dividing the result by 300 gpd to calculate the number of LUE's billed. If an LUE was based on 109,500 gallons per year (300 gpd) and an institution's yearly contribution was estimated to be 219,000 gallons, they would be charged twice the cost of a single family residence.

Based on an LUE of 109,500 gallons per year and the average daily flows shown in Table 8-1, the estimated monthly cost per LUE would be approximately \$88.05 and \$77.65 per month for the Core Business District and Central Business District respectfully. However, these amounts could decrease based on the actual loan amount, which could be reduced if local funds were collected at the beginning of the project. This initial funding sometimes takes the form of a capital recovery fee or a tap fee that is required for each connection to the system.

8.4 SCHEDULE

A preliminary schedule for implementation of the recommended alternative was developed in the present study, as shown in Figure 8-3. The preliminary schedule depicts construction of the Central Business District Option or the Core Business District System. From a practical standpoint, it would be assumed that the Core Business District System would be constructed as an initial phase. Then, it would be assumed that the complete Central Business District system would be constructed as additional development occurs in the area and system flows increase. The schedule for implementation of the full study area system is highly speculative in this feasibility study, but it is assumed for planning purposes that work is initiated approximately 15 years after construction of the initial phase.

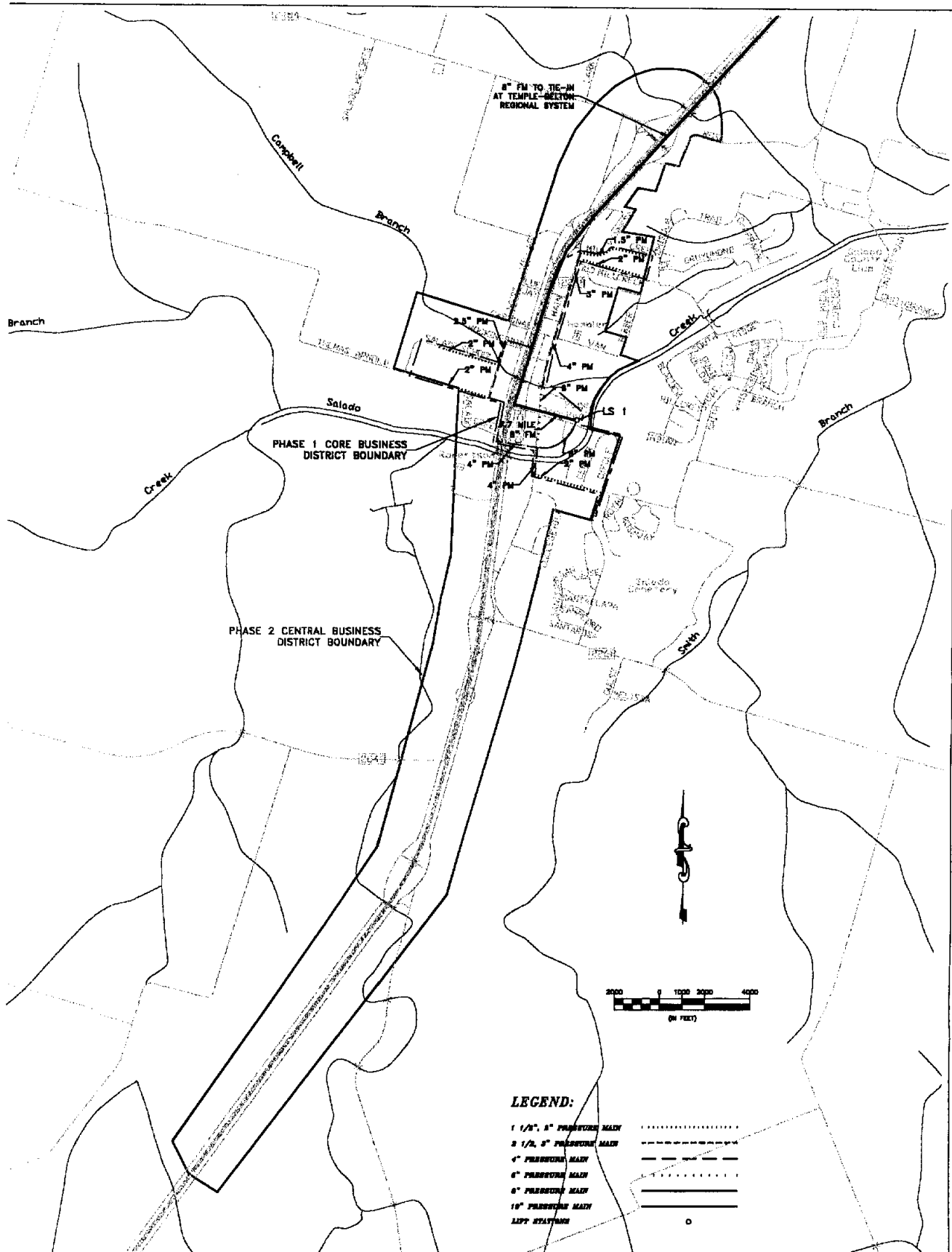

8" PM TO TIE-IN
AT TEMPLE-BELTON
REGIONAL SYSTEM

Campbell

Branch

Branch

1.5" PM
2" PM
3" PM
4" PM
6" PM
8" PM
10" PM
12" PM
15" PM
18" PM

1.5" PM
2" PM
3" PM
4" PM
6" PM
8" PM
10" PM
12" PM
15" PM
18" PM

Salado

PHASE 1 CORE BUSINESS
DISTRICT BOUNDARY

LS 1

Branch

Creek

PHASE 2 CENTRAL BUSINESS
DISTRICT BOUNDARY

Salado

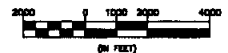

LEGEND:

- 1 1/8" 8" PRESSURE MAIN
- 3 1/2" 8" PRESSURE MAIN
- 4" PRESSURE MAIN
- 6" PRESSURE MAIN
- 8" PRESSURE MAIN
- 10" PRESSURE MAIN
- 15" PRESSURE MAIN
- 18" PRESSURE MAIN
- 150' STATIONING

JAMES MIERTSCHIN & ASSOCIATES, INC
ENVIRONMENTAL ENGINEERING

FIGURE 8-1
PHASE I
CORE BUSINESS DISTRICT

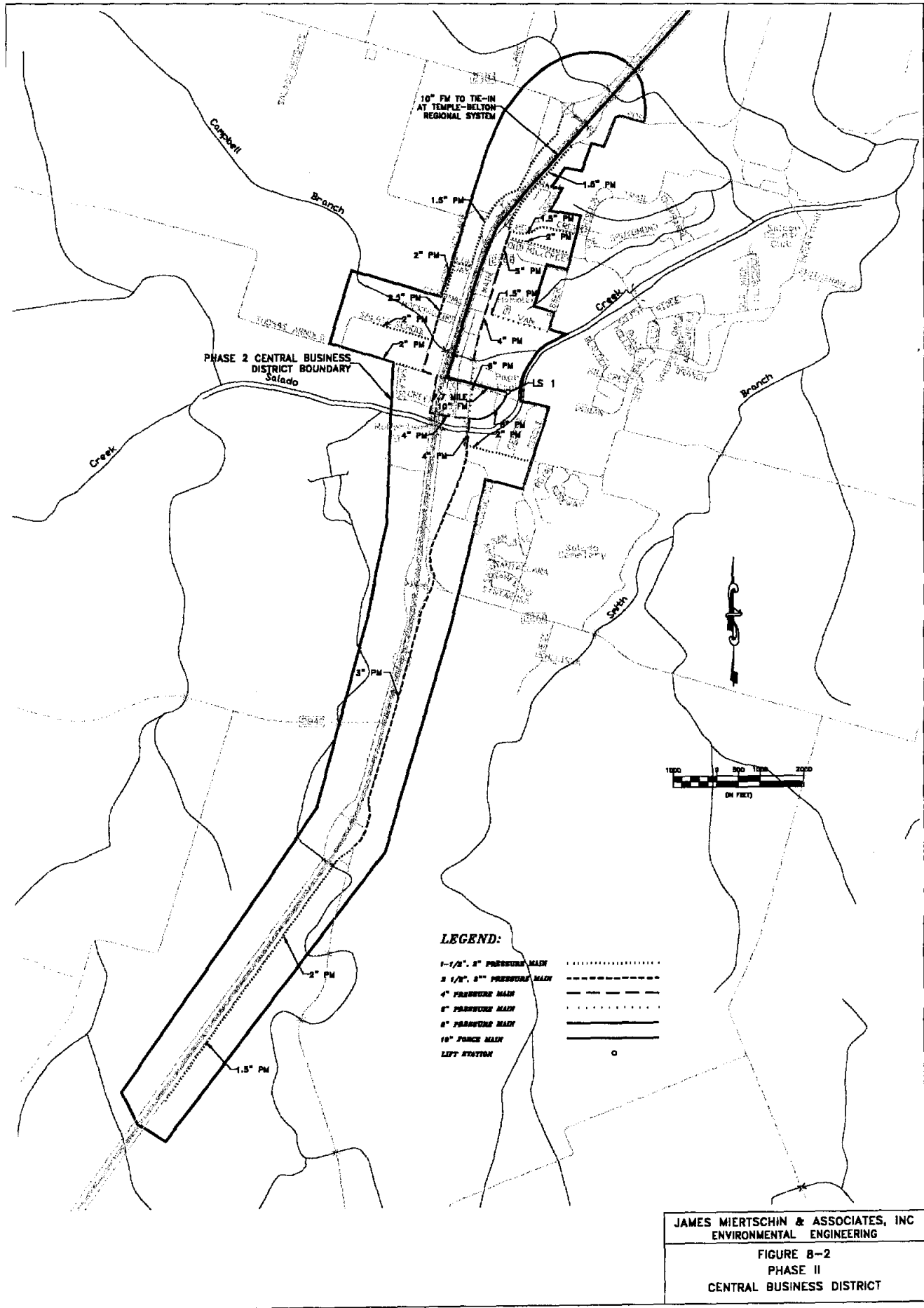

LEGEND:

- 1-1/2" 8" PRESSURE MAIN
- 2 1/2" 8" PRESSURE MAIN
- 4" PRESSURE MAIN
- 6" PRESSURE MAIN
- 8" PRESSURE MAIN
- 16" FORCE MAIN
- LIFT STATION

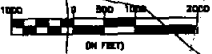

JAMES MIERTSCHIN & ASSOCIATES, INC
 ENVIRONMENTAL ENGINEERING
 FIGURE B-2
 PHASE II
 CENTRAL BUSINESS DISTRICT

	MONTHS																										
ACTIVITY	1	2	3	4	5	6	7	8	9	10	11	12	13	14	15	16	17	18	19	20	21	22	23	24	25	26	27
Planning/Preliminary Engineering	█																										
Design							█																				
Construction																█											

NOTE: Schedule begins with decision by Owner to proceed.

Figure 8.3
Preliminary Construction Schedule (Central Business District Option)

Table 8-1
Estimated Wastewater Flows - 30 Year Planning Horizon

Year	2001	2006	2011	2016	2021	2026	2031
Core Business District							
Average Daily	0.134	0.147	0.161	0.177	0.194	0.213	0.234
Avg. Daily Peak Month	0.174	0.191	0.210	0.230	0.252	0.277	0.304
Peak Instantaneous	0.536	0.588	0.645	0.708	0.776	0.852	0.934
Central Business District							
Average Daily	0.192	0.210	0.231	0.253	0.277	0.304	0.334
Avg. Daily Peak Month	0.249	0.273	0.300	0.329	0.361	0.396	0.434
Peak Instantaneous	0.766	0.841	0.922	1.012	1.110	1.218	1.336

Note: Wastewater flow values given in million gallons/day.

Table 8-2
Preliminary Construction Cost Estimates - Phased Approach

Item	Core Business District Phase	Entire Business District Phase
Material Costs	\$4,264,800	\$5,766,700
Contingencies and Fees	\$2,388,288	\$3,229,352
Total Capital Costs	\$6,653,088	\$8,996,052

Table 8-3
Projected Annual Operation and Maintenance Costs - Phased Approach

Item	Core Business District Phase	Entire Business District Phase
Collection System	\$49,905	\$49,905
Lift Stations	\$40,140	\$46,674
Treatment Plant	\$162,142	\$167,465
Total O&M	\$252,187	\$264,044

Table 8-4
Estimated Total Annual Costs - Phased Approach

Item	Core Business District Phase	Entire Business District Phase
Debt Service for Capital Cost	571,977	773,406
O&M Cost	252,187	264,044
Total Annual Cost	824,165	1,037,450

APPENDIX A

PRELIMINARY COST ESTIMATES - ALTERNATIVES 1 THROUGH 4

ALTERNATIVE 1

Preliminary Cost Estimates Study Area with Gravity System Connecting to Temple/Belton Regional Sewer System

Item	Unit	Unit Cost	Quantity	Component Price	Subtotal Price	Total Price
Transmission						
Gravity Pipe						
4 inch	LF	\$50	95400	\$4,770,000		
6 inch	LF	\$55	134600	\$7,403,000		
8 inch	LF	\$60	9200	\$552,000		
10 inch	LF	\$65	3100	\$201,500		
12 inch	LF	\$70	1200	\$84,000		
Pressure Pipe						
1 inch	LF	\$8	43900	\$351,200		
1.5 inch	LF	\$10	106600	\$1,066,000		
2 inch	LF	\$20	16000	\$320,000		
2.5 inch	LF	\$21	600	\$12,600		
3 inch	LF	\$22	8100	\$178,200		
4 inch	LF	\$25	2600	\$65,000		
Force Mains						
2.5 inch	LF	\$21	7900	\$165,900		
3 inch	LF	\$22	8300	\$182,600		
4 inch	LF	\$25	16400	\$410,000		
6 inch	LF	\$30	13600	\$408,000		
10 inch	LF	\$40	8000	\$320,000		
12 inch	LF	\$60	37600	\$2,256,000		
Grinder Pumps						
Single Unit	Each	\$3,000	435	\$1,305,000		
Duplex Unit	Each	\$8,000	4	\$32,000		
Manholes	Each	\$3,500	300	\$1,050,000	\$21,133,000	
Lift Stations						
LS1	Each	\$125,000	1	\$125,000		
LS2	Each	\$125,000	1	\$125,000		
LS3	Each	\$75,000	1	\$75,000		
LS4	Each	\$50,000	1	\$50,000		
LS5	Each	\$50,000	1	\$50,000		
LS6	Each	\$50,000	1	\$50,000		
LS7	Each	\$150,000	1	\$150,000		
LS8 (Booster to TBRSS)	Each	\$150,000	1	\$150,000	\$775,000	
Septic Tank Abandonment	Each	\$400	1393	\$557,200	\$557,200	
Upgrades to TBRSS						
12 inch FM	LF	\$60	9300	\$558,000		
TBRSS Tie-In Fee	LS	\$500,000	1	\$500,000	\$1,058,000	
Easement and ROW Acquisition	LF	\$1.50	513100	\$769,650	\$769,650	
TOTAL PROBABLE COMPONENT COST						\$24,292,850
Contingency (30%)						\$7,287,855
TOTAL PROBABLE CONSTRUCTION COST						\$31,580,705
Engineering, Surveying, Testing, Inspection (20%)						\$6,316,141
TOTAL PROBABLE PROJECT COST						\$37,896,846

ALTERNATIVE 2

Preliminary Cost Estimates Study Area with Gravity System and Treatment Facility

Item	Unit	Unit Cost	Quantity	Component Price	Subtotal Price	Total Price
Transmission						
Gravity Pipe						
4 inch	LF	\$50	95400	\$4,770,000		
6 inch	LF	\$55	134600	\$7,403,000		
8 inch	LF	\$60	9200	\$552,000		
10 inch	LF	\$65	3100	\$201,500		
12 inch	LF	\$70	1200	\$84,000		
Pressure Pipe						
1 inch	LF	\$8	43900	\$351,200		
1.5 inch	LF	\$10	106600	\$1,066,000		
2 inch	LF	\$20	16000	\$320,000		
2.5 inch	LF	\$21	600	\$12,600		
3 inch	LF	\$22	8100	\$178,200		
4 inch	LF	\$25	2600	\$65,000		
Force Mains						
2.5 inch	LF	\$21	7900	\$165,900		
3 inch	LF	\$22	8300	\$182,600		
4 inch	LF	\$25	16400	\$410,000		
6 inch	LF	\$30	13600	\$408,000		
10 inch	LF	\$40	8000	\$320,000		
12 inch	LF	\$60	7900	\$474,000		
Grinder Pumps						
Single Unit	Each	\$3,000	435	\$1,305,000		
Duplex Unit	Each	\$8,000	4	\$32,000		
Manholes	Each	\$3,500	300	\$1,050,000	\$19,351,000	
Lift Stations						
LS1	Each	\$125,000	1	\$125,000		
LS2	Each	\$125,000	1	\$125,000		
LS3	Each	\$75,000	1	\$75,000		
LS4	Each	\$50,000	1	\$50,000		
LS5	Each	\$50,000	1	\$50,000		
LS6	Each	\$50,000	1	\$50,000		
LS7	Each	\$150,000	1	\$150,000	\$625,000	
Septic Tank Abandonment	Each	\$400	1393	\$557,200	\$557,200	
Treatment Facility						
WWTP	Gallon	\$4.00	1120000	\$4,480,000		
WWTP Site	Acre	\$3,500	16	\$56,000		
Storage Pond	Ac-ft	\$12,000	198	\$2,376,000	\$6,912,000	
Irrigation System						
Pumping Station	Each	\$100,000	1	\$100,000		
12" FM	LF	\$60	10560	\$633,600		
Equipment	LS	\$50,000	1	\$50,000	\$783,600	
Easement and ROW Acquisition	LF	\$1.50	483400	\$725,100	\$725,100	
TOTAL PROBABLE COMPONENT COST					\$28,953,900	
Contingency (30%)					\$8,686,170	
TOTAL PROBABLE CONSTRUCTION COST					\$37,640,070	
Engineering, Surveying, Testing, Inspection (20%)					\$7,528,014	
TOTAL PROBABLE PROJECT COST					\$45,168,084	

ALTERNATIVE 3

Preliminary Cost Estimates

Study Area with Pressure System

Connecting to Temple/Belton Regional Sewer System

Item	Unit	Unit Cost	Quantity	Component Price	Subtotal Price	Total Price
Transmission						
Pressure Pipe						
1 inch	LF	\$8	139300	\$1,114,400		
1.5 inch	LF	\$10	180900	\$1,809,000		
2 inch	LF	\$20	35000	\$700,000		
2.5 inch	LF	\$21	6600	\$138,600		
3 inch	LF	\$22	23200	\$510,400		
4 inch	LF	\$25	23000	\$575,000		
6 inch	LF	\$30	11400	\$342,000		
8 inch	LF	\$35	700	\$24,500		
10 inch	LF	\$40	1200	\$48,000		
Force Mains						
10 inch	LF	\$40	8000	\$320,000		
12 inch	LF	\$60	37600	\$2,256,000		
Grinder Pumps						
Single Unit	Each	\$3,000	1382	\$4,146,000		
Duplex Unit	Each	\$6,000	11	\$88,000	\$12,071,900	
Lift Stations						
LS1	Each	\$125,000	1	\$125,000		
LS2	Each	\$125,000	1	\$125,000		
LS7	Each	\$150,000	1	\$150,000		
LS8 (Booster to TBRSS)	Each	\$150,000	1	\$150,000	\$550,000	
Septic Tank Abandonment	Each	\$400	1393	\$557,200	\$557,200	
Upgrades to TBRSS						
12 inch FM	LF	\$60	9300	\$558,000		
TBRSS Tie-In Fee	LS	\$500,000	1	\$500,000	\$1,058,000	
Easement and ROW Acquisition	LF	\$1.50	466900	\$700,350	\$700,350	
TOTAL PROBABLE COMPONENT COST						\$14,937,450
Contingency (30%)						\$4,481,235
TOTAL PROBABLE CONSTRUCTION COST						\$19,418,685
Engineering, Surveying, Testing, Inspection (20%)						\$3,883,737
TOTAL PROBABLE PROJECT COST						\$23,302,422

ALTERNATIVE 4

**Preliminary Cost Estimates
Study Area with Pressure System
and Treatment Facility**

Item	Unit	Unit Cost	Quantity	Component Price	Subtotal Price	Total Price
Transmission						
Pressure Pipe						
1 inch	LF	\$8	139300	\$1,114,400		
1.5 inch	LF	\$10	180900	\$1,809,000		
2 inch	LF	\$20	35000	\$700,000		
2.5 inch	LF	\$21	6600	\$138,600		
3 inch	LF	\$22	23200	\$510,400		
4 inch	LF	\$25	23000	\$575,000		
6 inch	LF	\$30	11400	\$342,000		
8 inch	LF	\$35	700	\$24,500		
10 inch	LF	\$40	1200	\$48,000		
Force Mains						
10 inch	LF	\$40	8000	\$320,000		
12 inch	LF	\$60	7900	\$474,000		
Grinder Pumps						
Single Unit	Each	\$3,000	1382	\$4,146,000		
Duplex Unit	Each	\$8,000	11	\$88,000	\$10,289,900	
Lift Stations						
LS1	Each	\$125,000	1	\$125,000		
LS2	Each	\$125,000	1	\$125,000		
LS7	Each	\$150,000	1	\$150,000	\$400,000	
Septic Tank Abandonment						
	Each	\$400	1393	\$557,200	\$557,200	
Treatment Facility						
WWTP	Gallon	\$4.00	1120000	\$4,480,000		
WWTP Site	Acre	\$3,500	16	\$56,000		
Storage Pond	Ac-ft	\$12,000	198	\$2,376,000	\$6,912,000	
Irrigation System						
Pumping Station	Each	\$100,000	1	\$100,000		
12" FM	LF	\$60	10560	\$633,600		
Equipment	LS	\$50,000	1	\$50,000	\$783,600	
Easement and ROW Acquisition						
	LF	\$1.50	437200	\$655,800	\$655,800	
TOTAL PROBABLE COMPONENT COST						\$19,598,500
Contengency (30%)						\$5,879,550
TOTAL PROBABLE CONSTRUCTION COST						\$25,478,050
Engineering, Surveying, Testing, Inspection (20%)						\$5,095,610
TOTAL PROBABLE PROJECT COST						\$30,573,660

APPENDIX B
PRELIMINARY COST ESTIMATES - PHASED SYSTEM

PHASE 1

Preliminary Cost Estimates

Core Business District with Pressure System
 Connecting to Temple/Belton Regional Sewer System

Item	Unit	Unit Cost	Quantity	Component Price	Subtotal Price	Total Price
Transmission						
Pressure Pipe						
1 inch	LF	\$8	25200	\$201,600		
1.5 inch	LF	\$10	12100	\$121,000		
2 inch	LF	\$20	8400	\$168,000		
2.5 inch	LF	\$21	600	\$12,600		
3 inch	LF	\$22	1100	\$24,200		
4 inch	LF	\$25	4600	\$115,000		
6 inch	LF	\$30	1400	\$42,000		
8 inch	LF	\$35	1200	\$42,000		
Force Mains						
8 inch	LF	\$35	40800	\$1,428,000		
Grinder Pumps						
Single Unit	Each	\$3,000	245	\$735,000		
Duplex Unit	Each	\$8,000	7	\$56,000	\$2,945,400	
Lift Stations						
LS1	Each	\$125,000	1	\$125,000		
LS8 (Booster to TBRSS)	Each	\$125,000	1	\$125,000	\$250,000	
Septic Tank Abandonment	Each	\$400	252	\$100,800	\$100,800	
Upgrades to TBRSS						
8 inch FM	LF	\$35	9300	\$325,500		
TBRSS Tie-In Fee	LS	\$500,000	1	\$500,000	\$825,500	
Easement and ROW Acquisition	LF	\$1.50	95400	\$143,100	\$143,100	
TOTAL PROBABLE COMPONENT COST						\$4,264,800
Contingency (30%)						\$1,279,440
TOTAL PROBABLE CONSTRUCTION COST						\$5,544,240
Engineering, Surveying, Testing, Inspection (20%)						\$1,108,848
TOTAL PROBABLE PROJECT COST						\$6,653,088

PHASE 2

Preliminary Cost Estimates

**Central Business District with Pressure System
Connecting to Temple/Belton Regional Sewer System**

Item	Unit	Unit Cost	Quantity	Component Price	Subtotal Price	Total Price
Transmission						
Pressure Pipe						
1 inch	LF	\$8	39200	\$313,600		
1.5 inch	LF	\$10	34400	\$344,000		
2 inch	LF	\$20	13400	\$268,000		
2.5 inch	LF	\$21	1000	\$21,000		
3 inch	LF	\$22	10800	\$237,600		
4 inch	LF	\$25	5600	\$140,000		
6 inch	LF	\$30	1400	\$42,000		
8 inch	LF	\$35	1200	\$42,000		
Force Mains						
10 inch	LF	\$40	40800	\$1,632,000		
Grinder Pumps						
Single Unit	Each	\$3,000	382	\$1,146,000		
Duplex Unit	Each	\$8,000	10	\$80,000	\$4,266,200	
Lift Stations						
LS1	Each	\$125,000	1	\$125,000		
LS8 (Booster to TBRSS)	Each	\$125,000	1	\$125,000	\$250,000	
Septic Tank Abandonment	Each	\$400	392	\$156,800	\$156,800	
Upgrades to TBRSS						
10 inch FM	LF	\$40	9300	\$372,000		
TBRSS Tie-In Fee	LS	\$500,000	1	\$500,000	\$872,000	
Easement and ROW Acquisition	LF	\$1.50	147800	\$221,700	\$221,700	
TOTAL PROBABLE COMPONENT COST					\$5,766,700	
Contengency (30%)					\$1,730,010	
TOTAL PROBABLE CONSTRUCTION COST					\$7,496,710	
Engineering, Surveying, Testing, Inspection (20%)					\$1,499,342	
TOTAL PROBABLE PROJECT COST					\$8,996,052	

APPENDIX C

TEXAS WATER DEVELOPMENT BOARD COMMENTS ON DRAFT REPORT



TEXAS WATER DEVELOPMENT BOARD



Wales H. Madden, Jr., *Chairman*
William W. McAdams, *Member*
Dario Vidal Guerra, Jr., *Member*

Craig D. Pedersen
Executive Administrator

Jack Hunt, *Member*
Thomas Weir Labatt III, *Member*
E. G. Rod Pittman, *Member*

April 11, 2002

Mr. Denis Qualls, P.E.
Regional Business Development Director
Brazos River Authority
4600 Cobbs Drive
P.O. Box 7555
Waco, TX 76714-7555

2002 APR 18 AM 10:31
RECEIVED
BRAZOS RIVER AUTHORITY

Re: Regional Wastewater Facility Planning Contract Between the Brazos River Authority (BRA) and the Texas Water Development Board (Board), Draft Report Entitled "Temple/Belton Regional Sewerage System Expansion to the Town of Salado Feasibility Study", Contract No. 2001-483-369

Dear Mr. Qualls:

Staff members of the Texas Water Development Board have completed a review of the draft report under TWDB Contract No. 2001-483-369. As stated in the above referenced contract, the BRA will consider incorporating comments from the EXECUTIVE ADMINISTRATOR shown in Attachment 1 and other commentors on the draft final report into a final report. The BRA must include a copy of the EXECUTIVE ADMINISTRATOR's comments in the final report.

The Board looks forward to receiving one (1) electronic copy, one (1) unbound single-sided camera-ready original, and nine (9) bound double-sided copies of the final report on this planning project.

Please contact David Meesey at (512) 936-0852 if you have any questions about the Board's comments.

Sincerely,

Bill Mullican
Deputy Executive Administrator
Office of Planning

cc: David Meesey, TWDB

Our Mission

Provide leadership, technical services and financial assistance to support planning, conservation, and responsible development of water for Texas.

P.O. Box 13231 • 1700 N. Congress Avenue • Austin, Texas 78711-3231
Telephone (512) 463-7847 • Fax (512) 475-2053
1-800-RELAYTX (for the hearing impaired)
URL Address: <http://www.twdb.state.tx.us>
E-Mail Address: info@twdb.state.tx.us
TNRIS - The Texas Information Gateway • www.tnris.state.tx.us
A Member of the Texas Geographic Information Council (TGIC)



Attachment 1**Review Comments On
Regional Wastewater Facility Grant for
"Temple/Belton Regional Sewerage System Expansion to the Town of Salado Feasibility
Study "
Contract No. 2001-483-369**

The report appears to incorporate the elements required by the scope of work. The following comments are offered for consideration:

1. Pages 7-9, second paragraph, erroneously states that the Board considers SRF loan applications on the third Thursday of each month. The Board normally meets on the third Wednesday, but no reference to a day of the week is even necessary in the sentence.
2. Pages 7-10, second paragraph, states that the TWDB, through its State Participation Program, can enter into an agreement with an entity to pay up to half of a project's cost initially. This limitation was removed during the last session of the legislature and the Board may now finance up to 100% of project costs through this program. The paragraph should be revised to state "up to 100%" of the project.
3. Table 5-1; Term "Material Costs" is unclear. Please use more of an accurate term as appropriate (e.g. 'Engineering & Construction' costs).