

Big Spring Regional Water Reclamation Project

Preliminary Design Report

October 29, 2007

Prepared for:

**Colorado River
Municipal Water District**



**Texas Water
Development Board
Contract No. 2005483550**

CMD04249



Prepared by:

Freese and Nichols, Inc.
4055 International Plaza
Suite 200
Fort Worth, TX 76109
817/735-7300

Prepared by:

David W. Sloan, P.E., BCEE

Lakshmi Priya Dhanapal



TABLE OF CONTENTS

1.0 INTRODUCTION..... 1-1

1.1 Project Background 1-1

1.2 Feasibility Study..... 1-1

2.0 AVAILABLE SOURCE WATER..... 2-1

2.1 Big Spring Wastewater Treatment Plant 2-1

2.2 Historical Flows..... 2-1

2.3 Historical Water Quality 2-3

2.4 Water Rights/ Use Limitations 2-6

3.0 POTENTIAL USES 3-1

3.1 Direct Non-Potable Irrigation..... 3-1

3.2 Direct Non-Potable Industrial 3-1

3.3 Raw Water Augmentation 3-2

3.4 Direct Potable Augmentation..... 3-2

4.0 WATER QUALITY & REGULATORY CONSIDERATIONS 4-1

4.1 Public Health Issues..... 4-1

 A. Pathogenic Microorganisms 4-1

 B. Emerging Contaminants 4-2

4.2 Blending Issues..... 4-4

4.3 Regulatory Criteria..... 4-4

4.4 Quality Requirements..... 4-5

5.0 PROPOSED TREATMENT FACILITIES..... 5-1

5.1 Proposed Treatment Sequence 5-1

5.2 Membrane Filtration 5-1

 A. Configuration – Direction of Flow 5-3

 B. Configuration – Pressure vs. Submerged..... 5-3

C. Membrane Pore Size	5-3
5.3 Reverse Osmosis.....	5-4
5.4 Ultraviolet Disinfection/ Advanced Oxidation	5-5
5.5 Storage Requirements	5-6
A. Source Water Storage	5-6
B. Off-Spec Effluent Storage	5-7
C. Filtrate Storage.....	5-8
D. Product Water Storage	5-8
E. Residual Storage Lagoons	5-8
5.6 Disposition of Residuals.....	5-9
A. Membrane Filtration Backwash.....	5-9
B. Reverse Osmosis Concentrate	5-10
C. Membrane Cleaning Residuals	5-11
5.7 Chemical Feed and Storage.....	5-11
A. Coagulant	5-11
B. Anti-Scalant	5-12
C. Acid.....	5-12
D. Caustic Soda	5-13
E. Sodium Hypochlorite	5-13
F. Detergent.....	5-13
G. Sodium Bisulfite	5-14
H. Hydrogen Peroxide	5-14
5.8 Treatment Building.....	5-14
A. Main Treatment Area.....	5-14
B. Electrical Equipment Area.....	5-15
C. Administration/Control.....	5-15
D. Visitor Center.....	5-15
5.9 Electrical Requirements	5-16
A. Big Spring WWTP.....	5-16
B. Reclamation Treatment Facility.....	5-17
5.10 SCADA/Controls.....	5-17
5.11 Site Requirements	5-18
6.0 PROPOSED TRANSMISSION FACILITIES.....	6-1
6.1 Source Water Pump Station	6-1
6.2 Source Water Pipeline	6-1

6.3	Reclaimed Water Pipeline.....	6-4
6.4	Reclaimed Water Pump Station	6-5
6.5	Concentrate Discharge Pipeline.....	6-5
6.6	Base 5 Modifications.....	6-5
7.0	PROBABLE PROJECT COSTS.....	7-1
7.1	Initial and Ultimate Sizing	7-1
7.2	Projected Capital Costs	7-1
7.3	Projected Operating Costs	7-1
7.4	Resulting Cost Savings	7-1
	A. Raw Water Pumping.....	7-1
	B. Diverted Water Pumping	7-2
7.5	Net Cost of Water Reclaimed.....	7-2
7.6	Comparison to Alternate Sources.....	7-3
	A. Lake Alan Henry.....	7-3
	B. Hovey Trough Ground Water	7-3
	C. Roberts County Ground Water	7-4
	D. Cost Comparison of Sources.....	7-4
8.0	ENERGY ISSUES.....	8-1
8.1	Projected Energy Requirements.....	8-1
8.2	Alternative Energy Concepts	8-1
8.3	Methane Gas Capture.....	8-2
	A. Big Spring Landfill	8-2
	B. Big Spring WWTP Anaerobic Digester.....	8-4
8.4	Solar Energy	8-6
8.5	Wind Energy.....	8-7
9.0	IMPLEMENTATION PLAN	9-1
9.1	Membrane Pilot Testing.....	9-1
9.2	Concentrate Discharge Permit.....	9-1

9.3	Regulatory Approval	9-1
	A. Reclaimed Water Use Authorization	9-2
	B. Reclaimed Water Treatment and Blending.....	9-2
	C. Filter Backwash Return	9-2
	D. Facility Construction.....	9-3
9.4	Public Education	9-3
9.5	Land Acquisition.....	9-3
9.6	Potential Funding Assistance.....	9-4
9.7	Proposed Project Schedule.....	9-4

LIST OF TABLES

Table 2.1	Big Spring WWTP Discharge Permit Parameters	2-4
Table 2.2	Big Spring WWTP Historical Effluent Quality	2-5
Table 2.3	Big Spring WWTP Effluent Chemical Quality.....	2-6
Table 7.1	Summary of Cost Comparison of Sources.....	7-5

LIST OF FIGURES

Figure 2.1 Effluent flows from the City of Big Spring WWTP..... 2-2

Figure 2.2 Flow Utilization Vs. Plant Capacity (2004 – 2006)..... 2-3

Figure 5.1 Proposed Treatment Schematic..... 5-2

Figure 5.2 Preliminary Site Plan..... 5-19

Figure 6.1 Proposed Source Water Pump Station 6-2

Figure 6.2 Big Spring WWTP with Source Water Diversion Pump Station and Pipeline..... 6-3

Figure 6.3 Reclaimed water pre-blending for stabilization..... 6-4

Figure 6.4 Aerial Plan showing reclaimed pipeline routing and RO concentrate..... 6-6

Figure 8.1 Landfill Gas Well (Courtesy: EPA)..... 8-3

Figure 8.2 Landfill Gas Systems (Courtesy: EPA)..... 8-3

Figure 8.3 PV Cell 8-6

Figure 8.4 Solar Resource Potential (Courtesy: Texas Environmental Center) 8-7

Figure 8.5 Wind Turbine 8-8

Figure 8.6 Wind Resources (Courtesy: Texas Environmental Center – TEC) .. 8-9

Figure 9.1 Proposed Project Schedule..... 9-5

LIST OF APPENDICES

Appendix A	Cost Estimates for Reclaimed Water.....	A-1
Appendix B	Cost Estimates for Alternate Sources.....	B-1
Appendix C	Correspondence with State Agencies	
	TCEQ Meeting 10-06-2004.....	C-1
	CRMWD & Big Spring Coordination Meeting 1-30-2007.....	C-2
	TCEQ Meeting 03-09-2007.....	C-3
Appendix D	Public Education and Information Material	
	Kickoff Meeting to Stakeholders 08-17-2004.....	D-1
	Public Information Strategy Development 06-21-2005.....	D-2
	Feasibility Report to Stakeholders 07-19-2005.....	D-3
	Feasibility Report to Public 07-19-2005.....	D-4
	Preliminary Design Report to Public 10-03-2007.....	D-5

REFERENCES

1. CRMWD Regional Water Reclamation Project Feasibility Study, Freese and Nichols, Inc., March 29, 2005.

1.0 INTRODUCTION

1.1 Project Background

The Permian Basin, like much of the Western United States, has been subjected to an unprecedented period of drought during the past nine years. While rains in the second half of 2004 and around year-end 2006-2007 have provided some relief from the current drought, reservoir levels remain low; and some reservoir yields have been shown to have declined. The Colorado River Municipal Water District is seeking new supplies and alternatives to continue providing a reliable and sustainable water supply to its member and customer cities. A promising source of supplemental supply originates from the treated wastewater currently discharged by cities in the CRMWD service area.

The District supplies water to its member cities of Big Spring, Snyder and Odessa, as well as several customer cities, including Midland, San Angelo and Abilene. Most of the water supplied is raw surface water from the three reservoirs CRMWD has constructed on the Colorado River: J. B. Thomas, E.V. Spence, and O. H. Ivie. These sources are supplemented by groundwater reserves in the western portion of the CRMWD service area, but additional supplies are expected to be needed to meet growing needs and to offset apparent losses in reservoir yields.

1.2 Feasibility Study

A study was completed in 2005 (*Regional Water Reclamation Project – Feasibility Study*) to determine the technical and economic feasibility of capturing unused wastewater effluent and providing additional treatment to reclaim it for use as a municipal water supply. Three regional projects were evaluated: one in Big Spring, one in Snyder, and one located between Odessa and Midland. The feasibility study concluded that all three projects were technically feasible, and the cost of the reclaimed water should be comparable with other sources of additional supplies currently under consideration by the District. However, the Big Spring project had the fewest obstacles to implementation, and appeared to be

the most cost effective of the three projects. The District has therefore elected to proceed with the next step toward the Big Spring project. This preliminary design report will describe the facilities to be included in the project, and outline the subsequent steps necessary to complete the project.

2.0 AVAILABLE SOURCE WATER

2.1 Big Spring Wastewater Treatment Plant

The Big Spring Wastewater Treatment Plant is located east of Big Spring, and is permitted by TCEQ to treat up to 3.8 MGD. The plant is a hybrid plant, including both fixed film and suspended growth biological processes. Raw wastewater is first screened and degrittied, then flows to a primary clarifier for removal of suspended solids. Primary effluent then proceeds to a single rock media trickling filter for biological stabilization and then is pumped to the aeration basin for additional biological treatment. The contents of the aeration basin flow to the final clarifier where the active biomass is separated from the treated effluent and recycled to the aeration basin. The effluent is chlorinated to kill potential pathogens, and then passes through a sand filter to remove suspended particles. Filtered effluent is treated with an additional chemical to neutralize the remaining chlorine and is then discharged into Beals Creek. The effluent discharge is subject to permit number 10069-001 issued by the Texas Commission on Environmental Quality.

2.2 Historical Flows

Historical effluent flow data for the Big Spring WWTP has been reviewed for the period from July 1999 to June 2006. Due to equipment problems with the effluent flow meter, no flow records are available for the period from June 2002 through December 2003. Recorded flows since the meter was returned to service are significantly lower, so the more recent flow records will be used in estimating the flow available for reclamation. For the remaining 2-1/2 year period of record, the average flow was 2.11 million gallons per day (MGD). **Figure 2.1** shows the maximum, minimum and average daily flows available from the City of Big Spring WWTP.

Figure 2.1 Effluent flows from the City of Big Spring WWTP

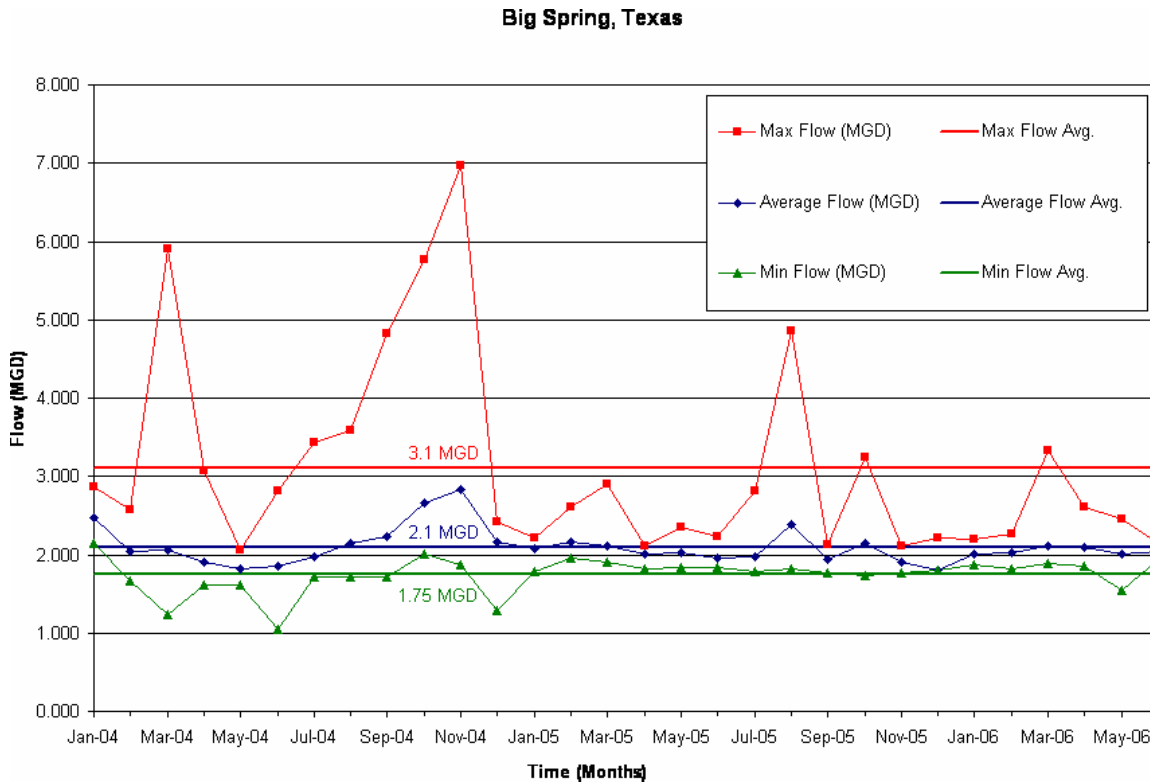

Municipal wastewater flows typically are highly variable, with a predictable pattern related to time of day, and a less predictable pattern day to day which is influenced by human activities and weather events. Long term storage of the effluent is not recommended due to the potential deterioration in water quality. Therefore, proposed reclamation treatment capacity selection requires a compromise between the lost resource of excess effluent on high flow days and the construction of excess capacity which is seldom utilized. For example, consider a 2 MGD plant. If effluent flows for 3 days are 1.9, 1.95 and 2.5 MGD, the plant can treat 1.9, 1.95 and 2.0 MGD on those days. The average flow for the period would be 2.12, but the average flow treated would be 1.95 MGD, and the utilization would be 97.5%. If the capacity was increased to 2.5 MGD, no effluent would go unused, and the average flow treated would be 2.12 MGD, but the utilization would drop to about 85%. Lower Utilization results in greater cost for facilities and hence for the water reclaimed.

The 30-month period of record for daily flow values was evaluated against various potential plant capacities to compare these competing factors. **Figure 2.2** contains a graph showing the theoretical percent utilization at a given capacity value as well as the average flow which could have been reclaimed with that capacity. For example, a 1.8 MGD plant theoretically could operate at capacity 99% of the time, but an average of 0.32 MGD of available effluent would go unused. Conversely, a 2.2 MGD plant theoretically could capture 2.01 MGD on average, but would only operate at 91% of capacity on average. A 2.1 MGD facility could capture almost as much, 1.98 MGD, and would average operation at 94% of capacity. This size appears to be a reasonable compromise based on the historical record. It should be noted that some additional loss of available effluent should be anticipated due to unusual flow fluctuations and potential effluent quality excursions which may require suspension of reclamation activities.

Figure 2.2 Flow Utilization Vs. Plant Capacity (2004 – 2006)

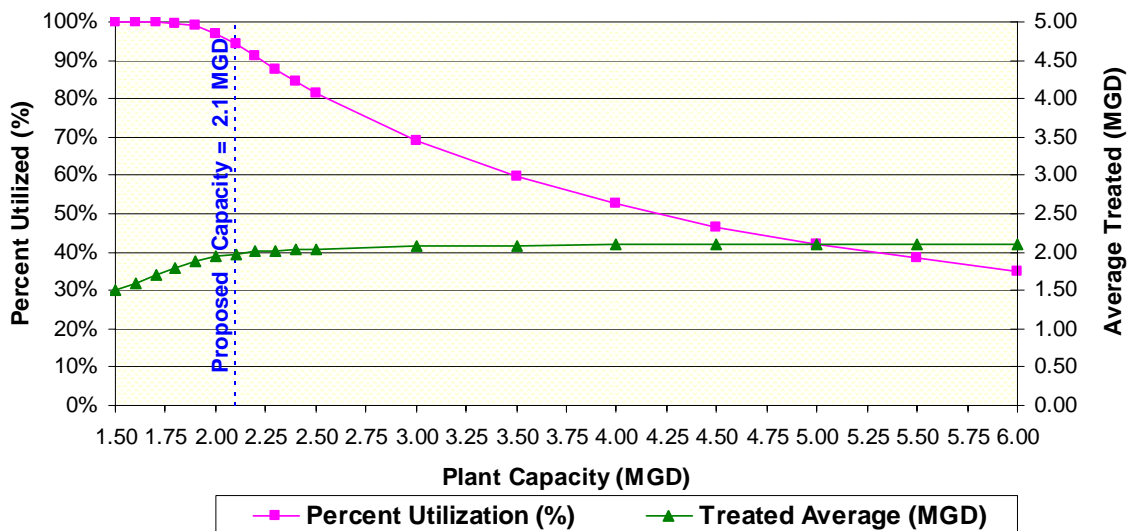

2.3 Historical Water Quality

The City of Big Spring produces a consistently high quality effluent. The allowable quality parameters stipulated in their discharge permit are shown in **Table 2.1**. Historical records of their effluent discharge quality are summarized in **Table 2.2**. They have consistently met requirements for biochemical oxygen

demand, total suspended solids, and dissolved oxygen. However, while the plant does a good job of removing suspended solids and biodegradable organics, the effluent is high in dissolved minerals, reflecting the general quality of water available in the Permian Basin region. Water supplied to Big Spring residents contains relatively high levels of hardness, chloride and sulfate, and these minerals are further elevated in the wastewater system due to normal domestic use and additionally due to the widespread use of home water softeners and reverse osmosis demineralizers, which discharge salt to the wastewater system. **Table 2.3** summarizes available data on the concentration of minerals and certain other chemical constituents in the Big Spring effluent.

Table 2.1 Big Spring WWTP Discharge Permit Parameters

Permitted Flow: 3.8 million gallons per day (Annual Average Daily Flow)

Allowable Effluent Constituent Concentrations (Maximum 30-day average)

Carbonaceous Biochemical Oxygen Demand	10 mg/l
Total Suspended Solids	15 mg/l
Ammonia-Nitrogen	(April-September) 3 mg/l
	(October-March) 4 mg/l

Minimum Required Dissolved Oxygen Concentration: 4 mg/l

Table 2.2 Big Spring WWTP Historical Effluent Quality

Period	Biochemical Oxygen Demand		Total Suspended Solids		Ammonia Nitrogen		pH	
	(Avg) mg/l	(Max) mg/l	(Avg) mg/l	(Max) mg/l	(Avg) mg/l	(Max) mg/l	LOW (Min)	HIGH (Max)
Jan-04	4.36	5.28	8.15	12.00	1.58	9.54	6.17	7.02
Feb-04	4.94	6.68	7.70	16.00	0.82	1.46	6.13	7.22
Mar-04	6.75	22.20	9.35	31.00	4.13	12.10	6.22	7.23
Apr-04	4.47	7.51	6.45	13.60	3.80	5.72	6.13	6.83
May-04	3.79	4.82	3.83	4.67	1.62	2.97	6.19	7.12
Jun-04	4.50	10.40	5.97	16.00	1.35	6.61	6.22	7.21
Jan-06	4.50	10.40	5.97	16.00	1.35	6.61	6.22	7.21
Feb-06	2.09	2.46	3.48	12.00	0.18	0.91	6.13	7.17
Apr-06	2.61	3.57	4.28	9.00	0.89	5.70	6.36	6.86
May-06	2.65	3.61	5.10	12.20	0.89	2.31	6.35	6.95
Jun-06	-	-	-	-	-	-	6.52	6.85
Min	2.09	2.46	3.48	4.67	0.18	0.91	6.13	-
Average	4.07	7.69	6.03	14.25	1.66	5.39	-	-
Max	6.75	22.20	9.35	31.00	4.13	12.10	-	7.23

Table 2.3 Big Spring WWTP Effluent Chemical Quality.

Constituent	Concentration (mg/l)			
	<u>8-Apr-04</u>	<u>2-Jul-04</u>	<u>24-Jun-05</u>	<u>12-Jan-06</u>
General Chemistry				
Bicarbonate Alkalinity	130	106	110	102
Chloride	798	585	1040	722
Fluoride	0.95	0.96	0.697	0.492
Nitrate	7.6	4.9	18	6.37
Sulfate	560	476	631	415
Total Organic Carbon	14.9	16.3	6.02	8.79
Total Metals				
Calcium	126	107	173	114
Magnesium	75.7	56.8	104	65.9
Potassium	28.6	23.5	35.2	28.8
Sodium	453	332	589	403
Silica(SiO ₂)	5.00	4.98	5.26	5.66
Dissolved Metals				
Barium	0.16	0.0981	0.0927	0.128
Iron	0.02	0.0636	0.0107	0.369
Manganese	0.197	0.148	0.0139	0.0882
Silica(SiO ₂)	4.94	3.96	5.53	5.59
Strontium	2.07	1.73	2.43	2.74
	<u>30-Mar-04</u>	<u>22-Jun-04</u>	<u>20-Dec-05</u>	
Conductivity	3671 uS/cm	2847 uS/cm	3566 uS/cm	
TDS	2184* mg/L	1694* mg/L	2122* mg/L	
* <i>Estimated value based on conductivity</i> <i>(TDS = 0.595 X Conductivity)</i>				

2.4 Water Rights/ Use Limitations

Current Texas Law allows treated effluent to be used, transferred or sold for appropriate uses until it is returned to the environment, at which time its ownership reverts to the state. CRMWD recently modified its member city agreement to allow transfer of unused effluent to the District for beneficial use. Currently the City of Big Spring does not have any commitments for reuse of its

wastewater effluent other than in-plant use of a small portion of the total flow. The effluent flow leaving the WWTP is discharged to Beals Creek. Due to the high natural mineral content of water in Beals Creek, the District operates a diversion facility which intercepts the flow in the creek. Under most conditions the entire flow is pumped to Red Draw Reservoir, an off-channel storage/evaporation reservoir constructed for this purpose. This practice minimizes the contribution of dissolved salts from Beals Creek to the Colorado River and Spence Reservoir.

3.0 POTENTIAL USES

The Big Spring effluent could be used in several ways, with a variety of requirements and constraints. The principal categories are discussed below.

3.1 Direct Non-Potable Irrigation

Many communities, including the City of Odessa, have made effluent available to golf courses, corporate campuses, or other large irrigation customers to take these demands off the potable water system. Secondary effluent such as that available in Big Spring, meets regulatory limits for such use and development of this type system is relatively straightforward. However, depending on the proximity of the user to the plant site, such systems can require a large capital investment to provide the piping network and other facilities necessary to deliver reclaimed water to the point of use. In the case of Big Spring, there are very few large landscape irrigation customers, due primarily to public recognition of the limited water supply. Irrigation is also somewhat limited by the salinity of existing supplies, and the wastewater effluent has higher concentrations of dissolved minerals. Irrigation use is further limited by its seasonal nature, with the result that much of the available winter supply goes unused.

3.2 Direct Non-Potable Industrial

Some local industries use significant quantities of water for their processes. Although much of this water is not required to meet drinking water requirements, some of the processes require water low in mineral content, resulting in significant investment in treatment equipment and operations. Some of the industries have expressed an interest in using demineralized effluent, even though its purchase price would be substantially higher than their current sources. Thus, the treatment proposed to produce water suitable for blending with the municipal supply may also produce a marketable product for direct sale.

3.3 Raw Water Augmentation

The Regional Water Reclamation Feasibility Study evaluated the blending of highly treated effluent into the raw water the District provides to its municipal customers. This practice was determined to be technically feasible, protective of public health, consistent with current regulations and economically competitive with other potential water supplies. This use also has the potential to utilize all of the effluent which can be diverted and treated by the proposed facility. Therefore, this use will remain the basis for the proposed facilities, although some of the product water may be sold to industrial users.

3.4 Direct Potable Augmentation

The processes proposed for the water reclamation facility are likely to produce water which consistently meets drinking water quality standards. Theoretically it would be possible to blend such water with other potable supplies such as the City's treated surface water. However, direct reuse significantly reduces the contaminant barriers in place to protect public health. Direct blending with potable supplies is therefore not recommended at this time. Future technological advances which allow provision of redundant barriers to pathogens and other contaminants of concern may overcome these limitations. Feasibility would depend on demonstrable protection of public health satisfactory to regulators and potential consumers.

4.0 WATER QUALITY & REGULATORY CONSIDERATIONS

4.1 Public Health Issues

Public health concerns regarding the use of reclaimed water center on water quality, treatment reliability, and the difficulty of identifying and estimating human exposure to potentially toxic chemicals and microorganisms that may be present. Public health protection is based on identifying potential contaminants and providing a series of barriers to prevent their passage into the finished water supply.

A. Pathogenic Microorganisms

Diseases are caused by a multitude of microorganisms that are broadly classified based on some of their common microbial characteristics. The principal infectious agents that may be present in reclaimed wastewater can be classified in three groups: bacteria, parasites and viruses.

Bacteria compose a large class of microscopic unicellular organisms with a size in the range of 0.2-15 μg and are responsible for numerous water-borne diseases, including cholera, dysentery and salmonellosis. Waterborne viral diseases that are most common are gastroenteritis and hepatitis A. For parasitic diseases the most common are those associated with *Giardia lamblia* and *Cryptosporidium parvum*. Diseases that are spread via water consumption and/or contact can be severe and sometimes crippling.

To some extent, an assessment of possible public health risk can rely on the vast knowledge that has been developed for water supplies using conventional source waters. Many of these source waters include varying amounts of treated domestic wastewater.

B. Emerging Contaminants

Some experts say that disinfected wastewater effluent originating from municipal treatment plants may create different and often unidentified disinfection byproducts than those found in protected natural water supplies. Since only a small percentage of the organic compounds in drinking water have been identified and the effects of only a few have been determined, the health effects of mixtures of two or more of the hundreds of compounds in any reclaimed water used for potable purposes are not easily characterized. Similar concerns may also apply to many other water supplies, which have various sources of contamination aside from municipal and industrial wastewaters. These may include urban and agricultural runoff, atmospheric pollutants, and naturally occurring contaminants such as arsenic and radon.

Continuous improvement in the field of laboratory analysis provides increasing knowledge of the nature and/or identity of the myriad substances which may be found in our water supplies. Some of these substances have legitimate health implications which should be considered in the general context of water treatment practice, but have particular importance in the evaluation and design of systems for treatment of reclaimed water for human consumption. Recent attention has focused on a broad range of chemicals which have been described as endocrine disruptors, personal care products, and/or pharmaceuticals.

The endocrine system is a combination of glands and hormones that affect biological reproduction, growth, and development. Endocrine disruptors are compounds that can block, mimic, stimulate, or inhibit the production of natural hormones, disrupting the endocrine system's ability to function properly. Endocrine disruptors can be natural or synthetic and persist in the environment and can bioaccumulate. Many chemicals, particularly detergents, resins, pesticides and plasticizers, are suspected endocrine

disruptors. Some human and livestock drugs are designed to be persistent in order to be effective.

Endocrine disruption is widespread. Pharmaceuticals, personal care products and their metabolites have been found in wastewater treatment plant effluent, surface water, and groundwater samples. Such endocrine disruptors find their way into the environment via wastewater, landfill leachate and agricultural and urban runoff. Exposure to endocrine disruptors can occur through direct contact with pesticides and other chemicals or through ingestion of contaminated water, food or air.

At present, regulatory action in the United States probably will be delayed until more research is done because most existing data on human-made chemicals focuses on cancer risks. Suspect contaminants appear in EPA's National Toxics Rule and in state regulations governing discharges of toxic substances. However, the rule does not specify which contaminants to monitor. Chemicals that are known human endocrine disruptors are dioxin, PCB's, DDT and some other pesticides. These pesticides were banned in the United States due to their carcinogenic effects, not their estrogenic effects.

In addition to endocrine disruption, some pharmaceutical and other chemicals are causing concern for other traits. Antibiotics from medications and from cleaning products are of interest due to the potential to allow widespread exposure and increased tolerance among the target organisms they are designed to attack. Other medications may have other unintended consequences that are not limited to the endocrine system. Another chemical gaining attention as an emerging contaminant is NDMA. This compound, known also as *N*-Nitrosodimethylamine, has long been recognized as toxic to humans, but has recently been identified as a potential by-product from disinfection with chlorine or chloramines.

Research on endocrine disruptors and effects of various treatment techniques is ongoing and is likely to continue for the foreseeable future. The variety of compounds involved and the wide range of characteristics make it likely that no single treatment step will be effective for all compounds of interest. Early indications are that biological nutrient treatment, reverse osmosis, and advanced oxidation are effective against many constituents.

4.2 Blending Issues

The proportion of reclaimed water to raw surface water after blending will vary significantly, depending on the amount of available effluent, the potential sale of reclaimed water to other users, and the amount of raw water pumped from Lake Spence at a particular time. The highest percentage of reclaimed water will occur when lower rates are pumped from Lake Spence, resulting in a blend of up to 20% reclaimed water in the Spence pipeline. As this water mixes with other sources, the percentage blend will decrease. During periods of higher pumping and direct sale of reclaimed water to industrial users, the blend in the pipeline may drop below five percent.

4.3 Regulatory Criteria

No regulations currently stipulate requirements for blending reclaimed water with municipal surface water supplies. A meeting with TCEQ staff was conducted during the feasibility stage of the project (October 2004) to explore this and other issues associated with the project. Staff representing the Water Supply Section indicated their overriding directive is to provide a raw water supply which allows the receiving systems to meet primary drinking water standards. The supply should also be equal or better than existing supplies with respect to secondary drinking water standards such as total dissolved solids and chlorides.

A second meeting with TCEQ staff took place March 9, 2007 and confirmed the information provided previously as well as addressing additional project details.

Agendas and minutes from both meetings with TCEQ staff are included in Appendix C.

4.4 Quality Requirements

The preceding paragraph notes the absence of specific criteria for reclaimed water which will augment municipal surface water. Due to the unique configuration of this project and the potential for public health concerns, a treatment regimen is proposed which will result in reclaimed water which meets all potable water standards. In addition to addressing public scrutiny, the resulting water will serve to improve water delivered in the Spence pipeline, due to the low mineral content (chlorides and hardness) as compared to Lake Spence water. Although the low blending ratio will limit noticeable improvements in the overall raw water quality, the superior quality in terms of TDS should be a welcome supplement to existing supplies.

5.0 PROPOSED TREATMENT FACILITIES

5.1 Proposed Treatment Sequence

Domestic wastewater contains a number of contaminants which are a concern to human health, including various pathogenic organisms and organic substances, both known and unknown. Standard wastewater treatment removes a large portion of these, but the remainder is left to biodegrade in the environment at varying rates. Additional treatment is required before this water can be considered equal to existing raw water supplies and safe for human consumption. The treatment sequence must be very reliable to inspire public confidence in the finished water. For the Big Spring Reclamation Project, a sequence consisting of membrane filtration, reverse osmosis and ultraviolet oxidation is proposed. A schematic of the proposed treatment is provided as **Figure 5.1**.

5.2 Membrane Filtration

The first treatment step will be membrane filtration, using either microfiltration or ultrafiltration membrane modules, which may be constructed in either a pressurized or submerged configuration. This step will remove particles remaining from previous treatment of the wastewater and associated turbidity. Membrane filtration will also remove protozoan cysts such as *Giardia* and *Cryptosporidia*, as well as most bacteria. Membrane filtration also provides excellent pre-treatment for reverse osmosis, which is proposed as the second treatment step.

Membrane filtration is the use of a manufactured surface, normally in the form of a hollow fiber, to separate or remove suspended particles from a liquid. This process is fundamentally different than conventional water treatment techniques and is rapidly changing the water treatment industry. Available membranes come in several alternative configurations and a range of pore sizes. The final selection will be made following pilot testing and cost proposals from qualified manufacturers, but some of the key properties are discussed below:

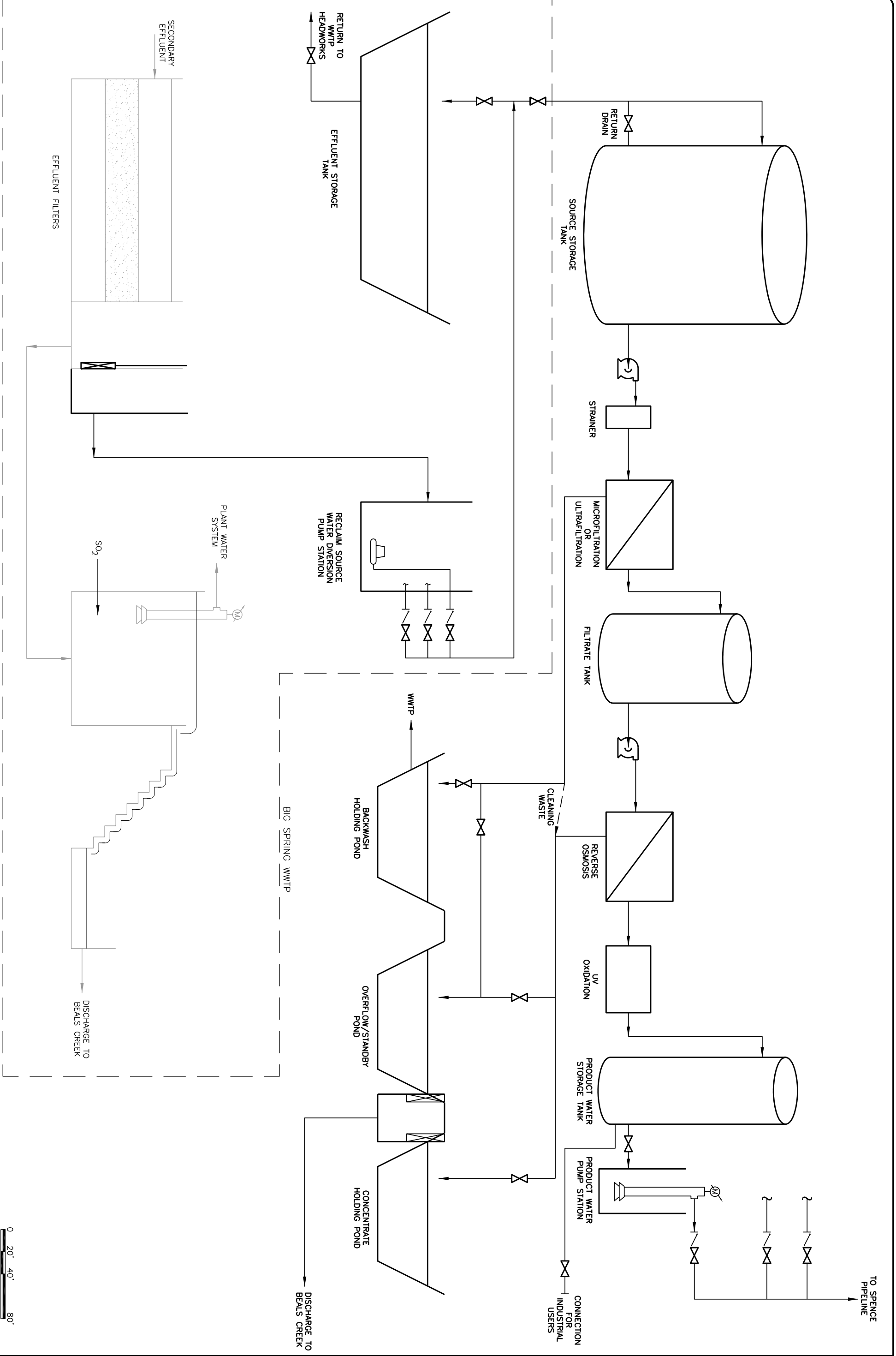

COLORADO RIVER MUNICIPAL WATER DISTRICT
BIG SPRING REGIONAL WATER RECLAMATION PROJECT

**BIG SPRING WWTP
 PROPOSED TREATMENT SCHEMATIC**

F&N JOB NO.	CMD04249
DATE	JAN 2007
SCALE	AS SHOWN
DESIGNED	DWS
DRAFTED	MAJ

FILE: MP-ALL-SM-ONEL.dwg

FIGURE 5.1

A. Configuration – Direction of Flow

Filtration membranes are typically arranged in a hollow-fiber configuration, resembling a long, narrow straw with a porous wall. Influent water is fed into a vessel that holds the membrane fibers. Treated water is typically collected inside the fibers at one end of the vessel as permeate. The reject will be collected outside the fibers and discharged outside the vessel. This is commonly called an “outside-in” configuration. Alternatively, in some systems influent is directed inside the fibers and flows out to be collected from the containment vessel. This arrangement is termed “inside-out”. Each configuration has tradeoffs, and there is no clear consensus on a preferred arrangement.

B. Configuration – Pressure vs. Submerged

Early membrane filters were arranged in horizontal pressure vessels resembling those already established in reverse osmosis equipment. However, some manufacturers developed vertical units which had some advantages in identifying hollow fibers which were broken or otherwise compromised. A few years ago, Zenon entered the market with a submerged unit, placing the hollow fibers in an open tank instead of a pressure vessel, and drawing the water through the membrane by suction rather than pressure. Additional manufacturers have followed suit, and numerous installations can be found for each configuration.

C. Membrane Pore Size

Micro-filters are defined by their pore size range of 0.1 to 1.0 μm . Ultra-filtration operates in a smaller filtration range (0.01 to 0.1 μm) and is commonly used for removal of oils, colloids and large molecular weight organics. Micro-filtration and Ultra-filtration differ not only in the particle size removed but also in operating pressure, due to the greater flow resistance which accompanies decreasing pore size.

5.3 Reverse Osmosis

Osmosis is a phenomenon observed when solutions of different concentrations are separated by a semi-permeable membrane. The term describes the tendency for water to flow from the lower concentration solution to the higher concentration solution until equilibrium is achieved. The pressure which drives this flow is termed osmotic pressure, and is a function of the relative concentrations of each solution. Reverse osmosis uses externally applied pressure to overcome the natural tendency, thereby separating water from a saline solution by forcing the water through a semi-permeable membrane. Reverse osmosis is a useful separation method since it permits the passage of water and rejects the passage of most ions and molecules other than water. It is commonly used to purify water and remove salts and other impurities in order to improve the color, taste or properties of the fluid.

Most reverse osmosis equipment is configured in a crossflow arrangement to allow the membrane to continually clean itself. As some of the fluid passes through the membrane the rest continues downstream, sweeping the rejected species away from the membrane. As the concentration of the fluid being rejected increases, the driving force required to continue concentrating the fluid increases due to the increasing osmotic pressure. Reverse osmosis modules are arranged in various configurations, sometimes using multiple stages to optimize the balance between the finished water quality and the percentage of water lost to the concentrate stream.

Reverse osmosis is capable of rejecting bacteria, salts, sugars, proteins, particles, dyes, and other constituents that have a molecular weight of greater than 150-250 daltons. The separation of ions with reverse osmosis is aided by charged particles. This means that dissolved ions that carry a charge, such as salts, are more likely to be rejected by the membrane than those that are not charged, such as organics. The larger the charge and the larger the molecule, the more likely it

will be removed from the water. The final configuration will be determined in cooperation with the system supplier after completion of pilot testing.

5.4 Ultraviolet Disinfection/ Advanced Oxidation

Reclaimed water disinfection is necessary to reduce transmission of infectious diseases and ultimately safeguard public health. There are a variety of treatment processes which may remove or otherwise reduce the population of pathogens in a water source, but disinfection is a process practiced specifically for this purpose.

Disinfection can be accomplished by the use of oxidizing chemicals such as chlorine, bromine, iodine, ozone, potassium permanganate, hydrogen peroxide, and chlorine dioxide. These chemicals can facilitate disinfection if organisms in water or wastewater are exposed to the proper dosage for the appropriate contact time. Chlorine is widely used for the oxidation of taste and odor chemicals as well as disinfection, but may be of limited benefit at the proposed reclaimed water facility since the Big Spring effluent is already chlorinated. Ozonation can also be used but is expensive and complex to operate.

Sunlight is a natural disinfectant, principally acting as a desiccant. Irradiation by ultraviolet lamps intensifies disinfection and makes it a manageable undertaking. The primary mechanism of UV light in inactivating microorganisms is direct damage of the cellular nucleic acids. Ultraviolet disinfection is well-established in wastewater treatment practice, and has more recently become an accepted disinfection tool for drinking water. An important benefit of UV disinfection is that it targets pathogens directly, with minimal effect on the chemical characteristics of the bulk water. UV disinfection has also been demonstrated to be effective against *Cryptosporidia* and *Giardia*, which are more resistant to chemical disinfection.

The concurrent application of UV light and hydrogen peroxide can be used to oxidize a wide variety of contaminants found in water. This technology requires the photolysis of hydrogen peroxide with UV light to generate hydroxyl radicals,

one of the most powerful oxidants known. These hydroxyl radicals react rapidly with organic constituents in water and break them down in many cases to their elemental form. UV oxidation will treat many dissolved organic compounds present in water, including certain endocrine disruptors, NDMA, pesticides and many algal toxins.

UV disinfection and advanced oxidation are particularly attractive for the Big Spring Reclamation Project and others preparing municipal effluent for augmentation of drinking water supplies. The UV disinfection provides an independent mechanism to kill pathogenic organisms which may be resistant to chlorination, which is already practiced at the wastewater treatment and water treatment plants. In addition, the advanced oxidation provides a tool to break down organic compounds which pass the reverse osmosis barrier. UV disinfection and advanced oxidation have been included in several recent or current potable reuse projects, including the large Groundwater Replenishment Project nearing completion by the Orange County Water District in California.

5.5 Storage Requirements

A. Source Water Storage

Section 2.2 describes the variability of daily effluent flows from the Big Spring WWTP. It is noted that no long-term storage is proposed for the effluent, due to potential deterioration of water quality. However, typical of all wastewater treatment facilities, there are significant hourly fluctuations as well, and these can be readily managed by providing short-term storage to even out variations and optimize capture of the available effluent.

Effluent flow records for the period of June 4-11, 2006 were analyzed to determine an appropriate storage volume to equalize available flow during typical operating conditions. Instantaneous flows recorded at two-hour intervals were used to represent the variation in flows. For the desired operation, the reclamation treatment facility would run at the average flow

rate over this period, 2.06 MGD; during high flow periods, excess effluent would be added to storage, and during low flow periods, stored water would be used to make up the deficit. Excess flows which cannot be stored will be discharged through the existing plant outfall.

For the period evaluated, a storage volume of 0.71 million gallons would have been required to allow continuous treatment at 2.06 MGD. A pre-stressed concrete storage tank is recommended for this purpose due to its corrosion resistance, long life and attractive appearance. A standard size of 750,000 gallons will meet the projected needs with a modest level of spare storage for additional flexibility.

B. Off-Spec Effluent Storage

Occasionally process upsets at the Big Spring WWTP could cause a decline in effluent quality that could be detrimental to the reclamation treatment facilities or could reduce the desired redundancy of the multiple barrier treatment regime. Under such conditions, influent pumping to the reclamation facility will be suspended, leaving effluent to be discharged to Beals Creek. Alternatively, the City of Big Spring could choose to divert the “off-spec” effluent to a temporary holding pond for storage. This stored effluent could be returned over time to the head of the WWTP for retreatment. This would avoid discharge of effluent which may not meet discharge standards and would capture the water for subsequent use. In such events, additional testing may be desirable to confirm there are no unusual contaminants which would represent a threat to the finished water quality.

A large existing holding basin is already constructed at the east end of the Big Spring WWTP which could be used for this purpose. The elevation is such that effluent would require pumping into the basin, but could be returned to the plant by gravity. The liner of the existing basin is deteriorated due to sunlight exposure and will require replacement prior to use. If the basin is

renovated for this purpose, it is recommended the new liner be protected by a soil-cement overlay.

C. Filtrate Storage

A small amount of filtrate storage is proposed to provide a supply of water for backwash and for continuity if a short interruption of either membrane stage is encountered. Approximately 200,000 gallons of storage is proposed, corresponding to just over two hours of membrane filtration production at full capacity. This tank should normally stay about one-half full and will help in balancing the production rate through the facility. If an unexpected outage of the membrane filtration occurs, the RO facility can continue to operate for at least one hour using the stored water as its source. Similarly, if the RO facility is required to make an unplanned shutdown, the membrane filtration stage can continue to operate for at least an hour, adding the water produced to storage. For planned events, the level can be manipulated to increase the available duration of an outage. A pre-stressed concrete tank is recommended for its corrosion resistance and for consistency with the recommended source water tank.

D. Product Water Storage

Storage of the product water is also recommended, to provide flexibility between the RO operation and the product water pumping. If the product water is sold to industries or other potential users, the product water storage tank will likely serve as the point of delivery, and the provision of adequate storage will assist operations by smoothing out any variations in product water demand or destination.

E. Residual Storage Lagoons

Membrane backwash and reverse osmosis concentrate are described below in Section 5.6. Although backwash from the membrane filtration will be returned

to the WWTP, a pond is recommended at the reclamation facility to equalize the flow and to hold it if necessary during periods of high influent flow at the WWTP. Similarly, a pond is recommended to collect the RO concentrate and membrane cleaning residuals to equalize flow and confirm that the water is neutralized prior to discharge into Beals Creek. During heavy rainfall events, the concentrate will be stored to allow fresh water flows in Beals Creek to continue downstream rather than diverted for evaporation. Having adequate storage will give the District flexibility to manage flows for the best overall benefit.

Three lagoon cells are proposed, each with approximately 200,000 gallons of storage. One will be dedicated for membrane backwash, and will hold approximately one day's storage at a backwash rate of 10%. The second cell will be dedicated for RO concentrate, holding approximately twelve hours' storage at a reject rate of 20%. The third pond will hold overflow from either use, during periods of non-discharge, or serve as a backup to facilitate maintenance activities. The ponds will be constructed earthen structures with a plastic liner and soil-cement overlay for protection against abrasion and sunlight.

5.6 Disposition of Residuals

The proposed treatment processes will result in several residual streams which must be handled.

A. Membrane Filtration Backwash

Filtration membranes require frequent backwashing or backpulsing to remove solids which accumulate on the membrane surface. The predominant source of these solids is likely to be bacterial cells which remain from the secondary treatment processes at the WWTP. The stream is generally 5-10 % of the source water, and is relatively dilute. A simple approach to handling this stream is to return it to the influent of the WWTP. Depending on the chemicals used in the filtration process, some solids may settle out in the

primary clarifiers, while the remainder will be re-exposed to the bacterial population in the aeration basin. This return flow will effectively increase the base flow of the WWTP, and the increased effluent will be available for diversion, treatment and reclamation.

The actual backwash will be characterized during pilot testing of the membrane filtration equipment. It is possible that the characteristics identified may dictate alternative handling methods, so this recommendation will be reviewed following completion of the pilot testing.

B. Reverse Osmosis Concentrate

The reverse osmosis process results in a large stream containing the concentrated dissolved solids which are rejected by the semi-permeable membrane. This stream is expected to be 20-25% of the flow entering this stage, and will mirror the chemical composition of the influent, but will be 4-5 times more concentrated. This stream must be excluded from the WWTP since any incorporation back into the bulk wastewater will result in increased operational costs for both the reclamation and wastewater treatment facilities, and could negatively impact the biological treatment processes.

A new outfall on Beals Creek is proposed for discharge of the RO concentrate. Due to the high ambient concentration of dissolved solids in the Beals Creek stream segment, this flow should not be detrimental to the aquatic life, or otherwise jeopardize the downstream environment. This will require obtaining a discharge permit from the TCEQ, to be discussed in the implementation section of this report. Alternatively, the concentrate may be pumped directly to Red Draw Reservoir to reduce the risk of excess minerals flowing beyond the controlled segment of Beals Creek and reaching Spence Reservoir and the Colorado River.

C. Membrane Cleaning Residuals

Both membrane processes will require periodic chemical cleaning of the membranes to maintain their efficiency and optimize their useful life. The cleaning protocols typically utilize acid, base, or oxidant solutions to dissolve or oxidize minerals, organics or biological growth which can foul or obstruct the membrane surface or pores. Most spent cleaning solutions can be neutralized and discharged. These solutions should be directed to the RO concentrate holding pond, which will require monitoring to confirm that discharged water is within an acceptable pH range and within other water quality limits which may be imposed by the permit. If special conditions require the use of any chemicals which are not suitable for discharge, specific arrangements for disposal will be required as appropriate. This issue will require review after pilot testing and proposal of cleaning agents by the membrane equipment supplier.

5.7 Chemical Feed and Storage

Several chemicals will be required for the optimum operation of the reclamation facility. The descriptions which follow are based on general requirements of the proposed treatment processes. Pilot testing will refine the determination of chemical requirements, and therefore some adjustments in chemical feed and storage provisions will be required for the final design. Chemical containment, safety and vulnerability to external threats must also be considered in final chemical selection and facility design.

A. Coagulant

Metal salts are frequently added in advance of membrane filtration to improve capture of organic colloids, reduce fouling, or otherwise improve the process operation. Specific testing and recommendations will be made by each manufacturer, but some level of coagulant addition can be expected. The dose is likely to be of sufficient magnitude to warrant the provision of a bulk storage tank for the coagulant. A 5000 gallon tank is recommended to allow

delivery of a typical 4000 gallon truckload, with reserve capacity available. Bulk storage can be provided by a cross-linked polyethylene tank located in a dedicated chemical storage area outside the main treatment building. A day tank, with metering pumps to provide appropriate coagulant dosing, will be provided within the treatment building.

B. Anti-Scalant

A key limitation of the reverse osmosis process is the concentration of “sparingly soluble” minerals which are subject to precipitation. As water passes through the membrane, the concentration of the remaining solution increases. If too much water is removed, some minerals (such as calcium sulfate or gypsum) will become “supersaturated” with a tendency to form crystals and deposit on solid surfaces. Such scaling can obscure the flow of water through the membrane sheet, and becomes the limitation on the amount of water which can be recovered from a given source.

Certain chemicals have been discovered to interfere with the reaction and subsequent crystallization of some of the problem minerals. These anti-scalant chemicals allow some minerals to be concentrated well beyond their normal saturation, and in many cases can greatly increase the recovery of usable water through desalination. Recommendation of specific anti-scalants will occur during pilot testing of the reverse osmosis equipment, but it is anticipated that such chemicals will be used in quantities compatible with the use of packaged containers such as drums or totes, and will be fed by liquid chemical metering pumps, all within the main treatment building.

C. Acid

The solubility of many minerals is dependent upon the pH of the solution, and lowering the pH is sufficient to keep some minerals in solution without targeted scale inhibitors. Acid addition is a typical component of RO facilities to manage scaling minerals and optimize the desalination process. Acid may

also be required for periodic membrane cleaning for either the filtration membranes or the RO membranes. Acid will probably be supplied in drums or totes, but space will be provided in the exterior chemical storage area to accommodate a bulk storage tank if it is determined to be needed.

D. Caustic Soda

Sodium hydroxide, or caustic soda, is used to raise water pH. It will not typically be required in the main process flow, but may be required for periodic cleaning, and will probably be needed to neutralize the RO concentrate prior to discharge. Caustic will be supplied in drums or totes, and will require indoor storage to maintain an acceptable temperature range to prevent crystallization.

E. Sodium Hypochlorite

Sodium hypochlorite, or common bleach, is normally used to prevent biological growth within the membrane filtration process. Most filtration membranes are now made of chlorine-tolerant materials, and the presence of a chlorine residual reduces the incidence of biological fouling. Although effluent diverted to the facility will have some level of chlorine residual, an additional dose may be recommended to optimize the operation. Sodium hypochlorite is also typically used for periodic maintenance and cleaning of the filtration membranes. Depending on requirements projected by the manufacturers, sodium hypochlorite may be provided in bulk, requiring a permanent storage tank, or may be supplied in drums or totes.

F. Detergent

Detergents are sometimes recommended for periodic cleaning of membranes. These are likely to be used in relatively small quantities, and should be provided in portable drums or totes.

G. Sodium Bisulfite

Contrary to filtration membranes, reverse osmosis membranes typically are not resistant to oxidative attack by chlorine. Therefore, a chemical reducing agent such as sodium bisulfite is typically added to the RO feedwater to neutralize the chlorine residual prior to contact with the membranes. Sodium bisulfite use will be continuous, but at a relatively low dose, so storage will likely be in portable drums or totes. This should be re-evaluated during the detailed design phase to confirm that bulk storage is not desired for the expected feed rate.

H. Hydrogen Peroxide

Hydrogen peroxide will be added upstream of the ultraviolet disinfection reactors for photolytic conversion to hydroxyl radicals, as described in Section 5.4. Hydrogen peroxide will likely be delivered and stored as a bulk liquid. Although the rate of use will be modest, it is stable and may be stored for relatively long periods.

5.8 Treatment Building

A significant amount of enclosed space will be needed for the Reclamation Treatment Facility. Anticipated space needs include the main treatment area, electrical equipment area, administration/control, and visitor center.

A. Main Treatment Area

The main treatment area will house the membrane filtration, reverse osmosis, ultraviolet disinfection and chemical feed facilities. This space will require high ceilings to accommodate the equipment, and will require generous ventilation to prevent accumulation of excess moisture or chemical fumes. Modest climate control is recommended to prevent extreme temperatures within the treatment area, maintaining a range of 50-90°F. Due to the presence of significant moisture and potential hydrogen sulfide emissions

from the adjacent wastewater treatment facility, moderate corrosion protection of the facilities will be necessary. The total space requirement will vary somewhat with the configuration and manufacturer selections, but is expected to be in the range of 5000 sq. ft.

B. Electrical Equipment Area

The proposed facility will have significant electrical loads, requiring a corresponding level of electrical support equipment, including switchgear and motor control equipment. A separate room with a controlled environment is recommended to protect the electrical equipment. The preliminary estimate for this room size is 12' x 24'.

C. Administration/Control

The reclamation facility is expected to operate with a limited staff, and will be relatively convenient to the District's headquarters on the south side of Big Spring. Therefore, administrative space requirements will be modest. A single office is proposed, with space included for a computer workstation to monitor and control the reclamation facility. A "clean" workbench should be included, either in the office or in the training room to allow work on electronic equipment in a controlled environment. An additional workbench or counter, with sink, should be provided in the treatment area for maintenance of process and mechanical equipment.

D. Visitor Center

The Big Spring Water Reclamation Project may be the first to blend repurified municipal effluent into a raw surface water pipeline, and will attract significant attention in the water supply industry. As more water providers look to reuse as a viable source of municipal water supply, it is anticipated there will be an interest in touring the facility and discussing its operation and development. This facility could also provide educational opportunities

beyond the water supply industry, to schoolchildren and the general public. We therefore recommend that a suitable welcome center and training room be provided as part of this facility, although it is not required. The training room will likely be useful for District training functions unrelated to the reclamation project with its proximity to the District's headquarters and might possibly be used for community events as well. Public restroom facilities will also be necessary, to be sized compatible with the number of visitors to be accommodated.

5.9 Electrical Requirements

Electrical modifications will be required at the existing plant in addition to the new service for the reuse treatment. The modifications to the existing plant will provide power to the pumps that will transfer water to the reuse treatment facility. Since the reuse treatment facility is a new structure that will include both membrane and reverse osmosis treatment, a new electrical service will be required.

A. Big Spring WWTP

At the wastewater treatment plant, three small (900 gpm each) constant speed pumps will be provided to transfer the treated water to the reuse treatment facility. It is anticipated that the existing service to the wastewater treatment plant will be able to provide power to these pumps, but a detailed evaluation will be provided in the design phase. As these pumps are not considered a critical load, there is no need for them to be served by an emergency generator. A simple on/off control of the pumps will be used to maintain a level range in the source water storage tank at the reuse treatment facility, so level control status from the tank will be required for the transfer pump control.

B. Reclamation Treatment Facility

Based on the preliminary equipment sizes, the electrical service for the reclamation treatment facility will be an 800 amp service, at 480 Volts. This will provide power to the membrane feed pumps, the strainers, the reverse osmosis feed pumps, finished water pumps, chemical feed system, cleaning systems, HVAC equipment, lighting and miscellaneous loads. A dry-type transformer will be provided to reduce the 480 volt power down to 120/208 volt power for use by the controls and miscellaneous loads. Although the reuse treatment is environmentally critical, it is not considered an electrically critical facility. Therefore, an emergency generator is not required to keep the facility in service.

5.10 SCADA/Controls

Typically the controls for membrane treatment equipment are provided as a package with the instruments from the membrane treatment supplier. Similarly, the reverse osmosis supplier typically provides the controls for their process. In addition, there is a requirement for monitoring the source water storage tank and the product water pump station. Neither of these items fit into the controls for the membrane or reverse osmosis controls. If the programmable logic controllers (PLC) for each of the processes use the same communications protocol, it is much simpler to integrate the systems. To allow the system to be monitored and operated remotely, it will be necessary to provide interface software regardless of the PLC used. The typical PLCs used by the membrane and reverse osmosis manufacturers are either the Allen Bradley PLC or the Modicon PLC. Both of these PLCs are good, flexible and powerful; however, Modicon is currently used by CRMWD and would thus be preferred. Either of these PLCs can be integrated into the current interface software, but both additional programming would likely be reduced with the use of equipment from a common supplier.

5.11 Site Requirements

Numerous factors should be considered in choosing and developing the site for the reclamation treatment facility.

- The facility should be in reasonable proximity to the wastewater treatment plant to facilitate access to the treated effluent and to allow return of membrane backwash water.
- The site should be located near Beals Creek to allow discharge of the desalination concentrate.
- The location should facilitate routing of the reclaimed water to the designated injection point on the Spence Pipeline.
- The site should meet normal engineering and environmental considerations, including suitable soils, drainage, protection from flood hazards, and free from contamination or other restrictions.
- The location should have access to adequate power supply.
- Easy access to major roads is preferred.
- Current site ownership should minimize likelihood of a contested acquisition.

The land west of the Big Spring Wastewater Treatment Plant is owned by the City of Big Spring and appears to have ample usable space to accommodate the proposed facilities. Although the northern portion of this site is within the 100-year flood plain, there appears to be sufficient space to construct the facilities without encroaching on the flood zone. Being located adjacent to the plant provides access to the source water, with easy return for the backwash waste. The site is near Beals Creek as well as F.M 700, which will likely facilitate routing of the reclaimed water line as well as providing road access.

A preliminary site plan for this location is shown in **Figure 5.2**.

Date: Jun 26, 2007 - 9:49am User: mlg File: N:\WW\Report\SITEPLAN1.dwg



COLORADO RIVER MUNICIPAL WATER DISTRICT
BIG SPRING REGIONAL WATER RECLAMATION PROJECT

PRELIMINARY SITE PLAN

F&N JOB NO.	CMD04249
DATE	JAN 2007
SCALE	AS SHOWN
DESIGNED	DWS
DRAFTED	MAJ

FILE SITEPLAN1.dwg



6.0 PROPOSED TRANSMISSION FACILITIES

6.1 Source Water Pump Station

Effluent should be diverted at a point which takes maximum advantage of the treatment capabilities of the City's existing facility. This dictates intercepting the effluent after filtration and chlorination, but prior to discharge. **Figure 6.1** illustrates the current facilities in the area of the filters and outfall structure.

Three pumps with variable frequency drives are proposed to closely match the flow of available effluent. Excess flows beyond the pump station capacity or not meeting desired quality criteria would continue through the existing outfall for discharge to Beals Creek.

As shown in **Figure 6.1**, a submersible pump station is proposed east of the chlorine contact basin, with a piping connection to the filter effluent channel. Filtered, chlorinated water would flow from the effluent channel to the new wet well by gravity, with a normal water level maintained below the elevation of the overflow weir in the outfall structure. An alternate location west of the outfall structure was also considered, but would interfere with the City's plans to renovate the pump station which supplies in-plant water needs.

6.2 Source Water Pipeline

Diverted flow from the new pump station would be piped to the influent storage tank located on the District's proposed Water Reclamation Facility site. If the site west of the WWTP is acquired, piping can be routed along the south side of the plant, where there is adequate clear space to accommodate it. A northern route was considered, but is more subject to conflicts. **Figure 6.2** illustrates the entire WWTP site, with the alternative pipe routing options indicated.

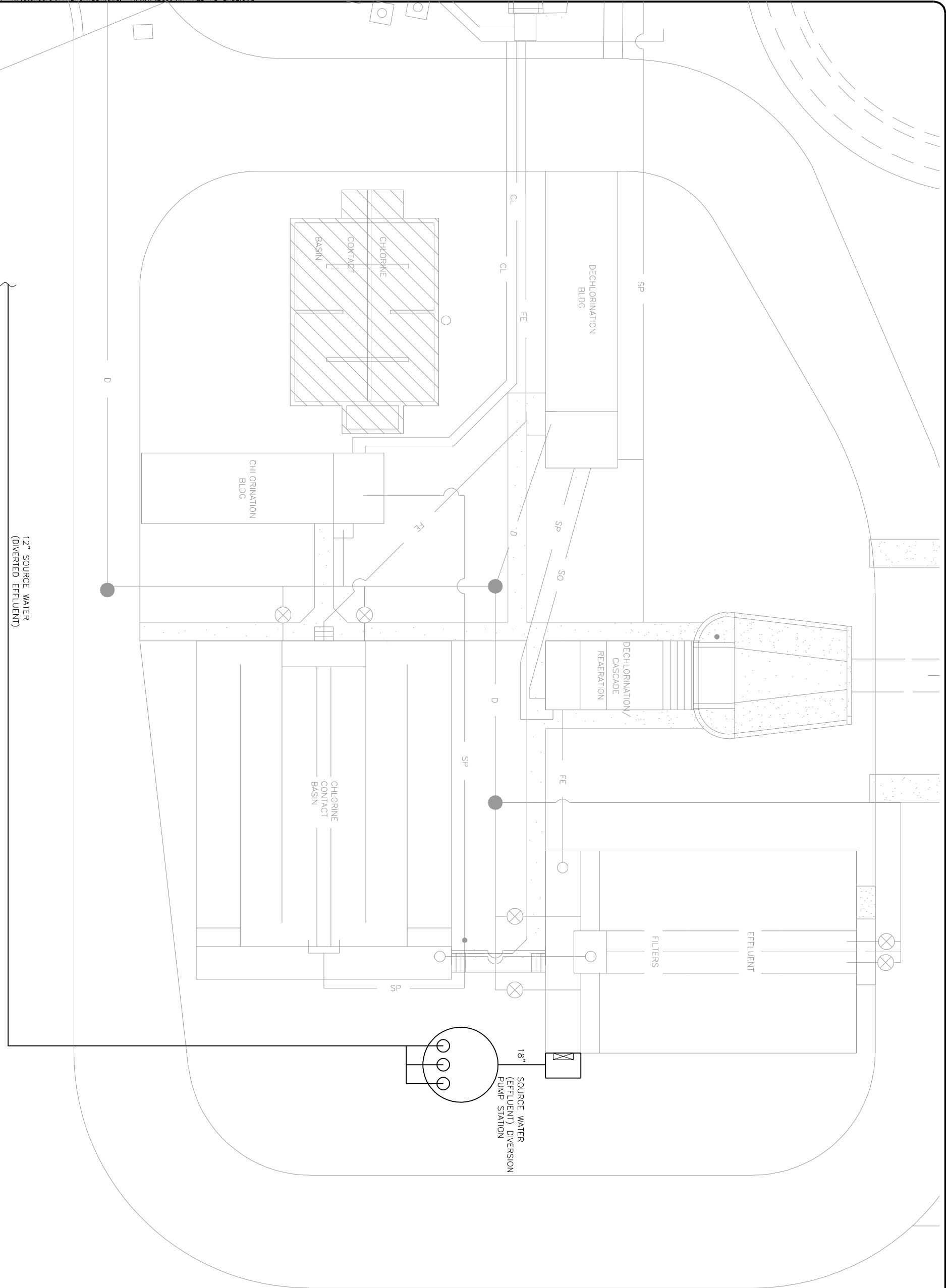

0 10' 20'
SCALE IN FEET



COLORADO RIVER MUNICIPAL WATER DISTRICT
 BIG SPRING REGIONAL WATER RECLAMATION PROJECT

PROPOSED SOURCE WATER PUMP STATION

F&N JOB NO.	CMD04249
DATE	JAN 2007
SCALE	AS SHOWN
DESIGNED	DWS
DRAFTED	MAJ

FILE MP-ALL-PL-SITE02.dwg

Date: May 01, 2007 - 1:46pm User: maj File: N:\WW\MP-ALL-PL-SITE01.dwg

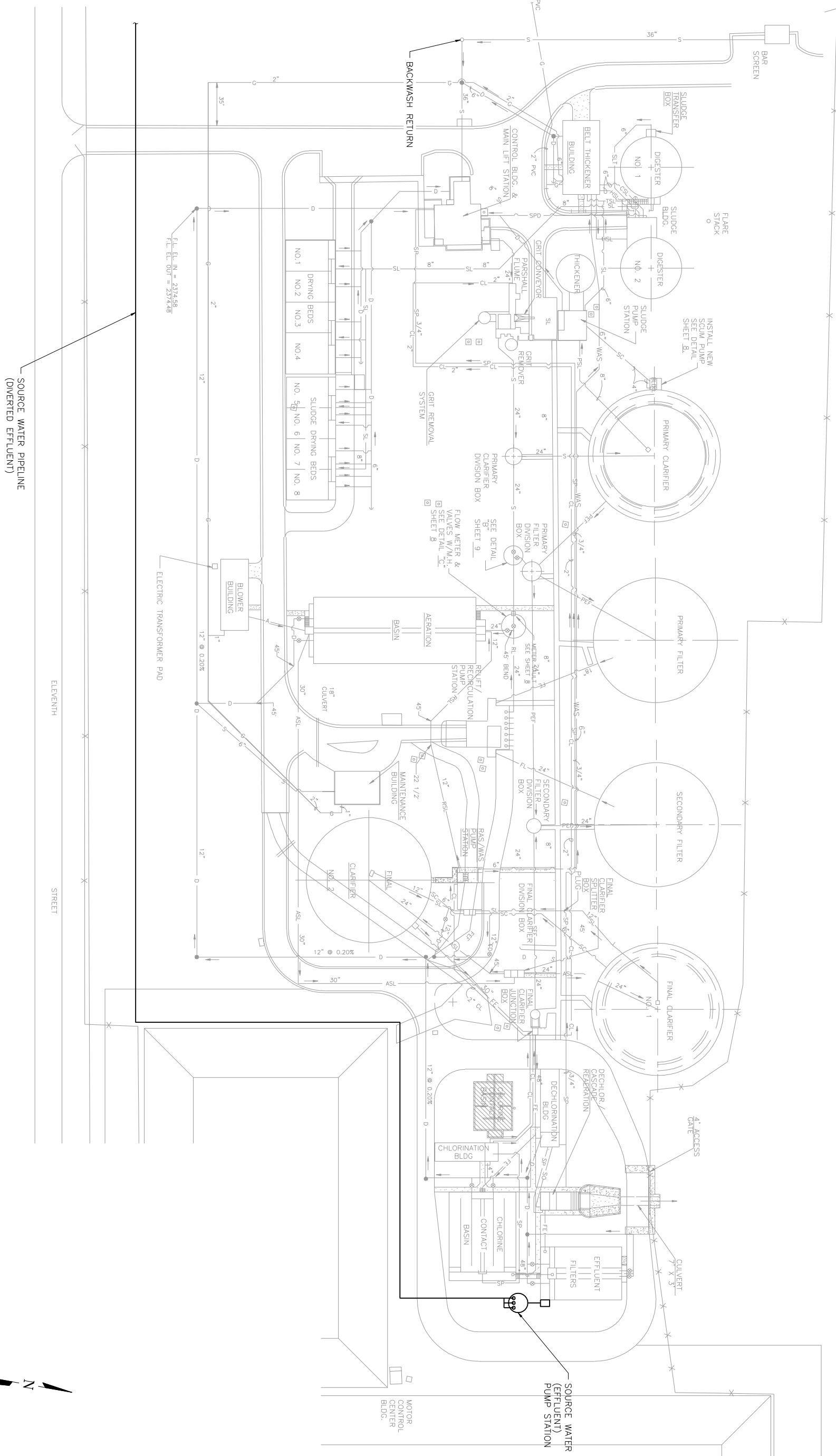

SOURCE WATER PIPELINE
(DIVERSED EFFLUENT)

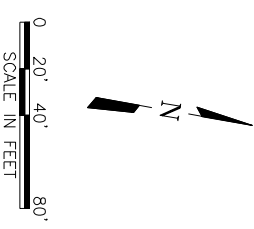

COLORADO RIVER MUNICIPAL WATER DISTRICT
BIG SPRING REGIONAL WATER RECLAMATION PROJECT
BIG SPRING WWTP
SOURCE WATER DIVERSION PUMP STATION AND PIPING

F&N JOB NO.	CMD04249
DATE	JAN 2007
SCALE	AS SHOWN
DESIGNED	DWS
DRAFTED	MAJ



6.2
FIGURE

FILE: MP-ALL-PL-SITE01.dwg

6.3 Reclaimed Water Pipeline

Preliminary routing includes placement of the reclaimed water pipeline along the western side of F.M. 700, north to Interstate Highway 20. From there the line must cross both F.M. 700 and I.H. 20, then bear northeast to intercept the Spence pipeline before its crossing of the Missouri & Pacific railroad. PVC is the recommended pipe material for this line due to the potential for corrosion of metal surfaces. The demineralization resulting from the reverse osmosis treatment yields water which has a high affinity for metal ions, and therefore is quite corrosive to metal or concrete.

The water from Lake Spence is high in dissolved solids, so the blended Spence and reclaimed water will not be corrosive. To protect the existing cement-lined steel pipeline, pre-blending is recommended. This will consist of a short bypass line which is constructed of FRP or other non-corrosive pipe to allow mixing of the reclaimed water with the Spence water prior to return into the existing pipeline. This arrangement is illustrated in **Figure 6.3** below.

Figure 6.3 Reclaimed water pre-blending for stabilization

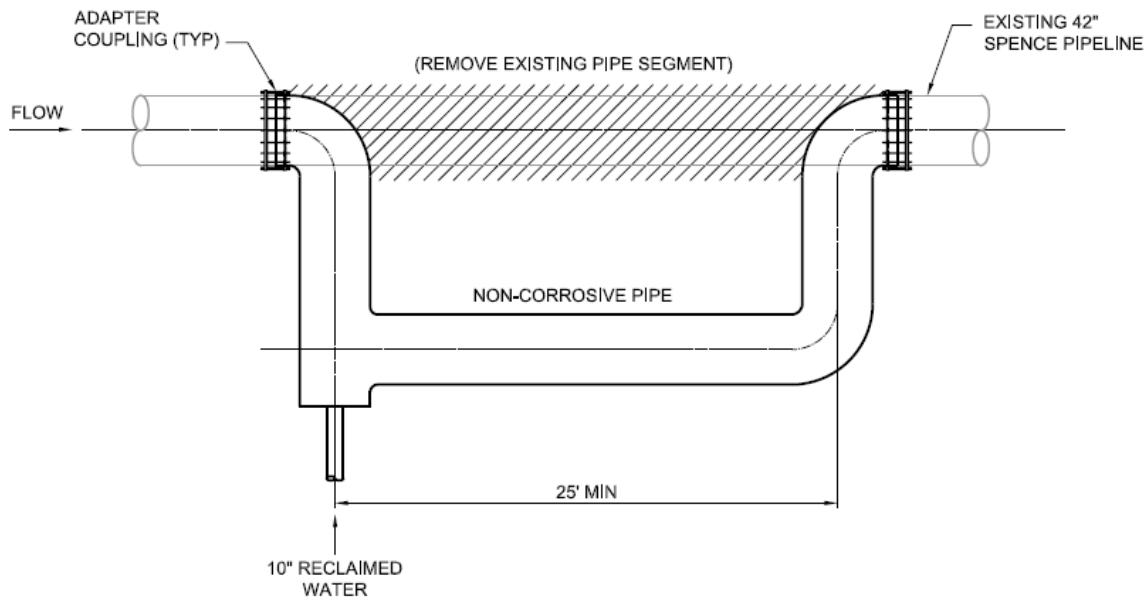

6.4 Reclaimed Water Pump Station

A simple pump station is proposed to pump the purified water from the reclamation plant to the Spence Pipeline. Can-type vertical turbine pumps are proposed, located near the product water storage tank. Three constant-speed pumps with a capacity of 700 gpm each will provide a firm capacity equal to the plant capacity. Wetted parts must be manufactured of non-corrosive materials due to the lack of buffering minerals in the product water. Pumps will cycle on and off based on water level in the product water tank.

6.5 Concentrate Discharge Pipeline

As described in Section 5.3, the second reclaim treatment step will be reverse osmosis, using membranes for molecular separation, removing minerals and dissolved organics. A significant stream, estimated to be about 20% of the incoming flow, will be generated which contains the segregated salts and other constituents. Although technology exists to further concentrate this stream, it is not anticipated to be cost effective for the Big Spring project. This stream will not benefit from any of the treatment processes in place at the WWTP, but rather would contaminate the effluent, making it more difficult to treat and reclaim. Due to the recognized water quality limitations of Beals Creek, it is anticipated that a direct discharge permit can be obtained for the RO concentrate. The pipeline containing the RO discharge is proposed to be routed to Beals Creek as shown in **Figure 6.4**.

6.6 Base 5 Modifications

The existing pipeline from Spence Reservoir terminates at a 15 million gallon earthen reservoir north of Big Spring. The reservoir site is designated as Base 5, and also includes a pump station which lifts water continuing west toward Odessa. Also connected at Base 5 is a pipeline from Lake J.B. Thomas. Several interconnections between the pipelines provide the District flexibility in routing water from different combinations of sources to improve the overall water quality provided to the District's customers.

Date: Jun 26, 2007 - 9:47am User: mlg File: N:\WW\Report\SITEPLAN1.dwg

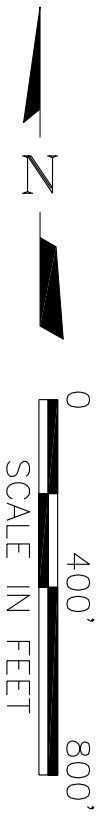

FIGURE 6.4



COLORADO RIVER MUNICIPAL WATER DISTRICT
BIG SPRING REGIONAL WATER RECLAMATION PROJECT

RECLAIMED WATER PIPELINE ROUTE

F&N JOB NO.	CMD04249
DATE	JAN 2007
SCALE	AS SHOWN
DESIGNED	DWS
DRAFTED	MAJ

FILE SITEPLAN1.dwg

Water from the Spence pipeline normally enters the Base 5 reservoir before being pumped west to Odessa or flowing to the City of Big Spring. The Base 5 reservoir provides an opportunity to expose the blended reclaimed water to the natural elements of sunlight and atmosphere, which may improve the quality of the water supply and provides visible separation of the sources. We recommend the District avoid operations which would allow the reclaimed water to short-circuit the Base 5 reservoir.

7.0 PROBABLE PROJECT COSTS

7.1 Initial and Ultimate Sizing

The proposed 2.1 MGD sizing for the facility is explained in Section 2.2. The proposed size is designed to take advantage of the full output of the Big Spring WWTP, and available effluent is not anticipated to change significantly in the next several years. Furthermore, the raw water augmentation program is able to take the entire production capacity from the proposed facility, beginning as soon as it is available. Membrane filtration equipment is typically designed to accommodate the addition of membrane elements to allow modest increases in capacity or adaptation to changed conditions. RO systems can be designed with similar provisions. This level of flexibility is expected to be sufficient for this project, and no other phasing is proposed.

7.2 Projected Capital Costs

The projected capital costs have been updated from the *Feasibility Study* and are included in **Appendix A**. While many construction costs, including general equipment, piping and building costs have increased significantly in the past 2 years, the membrane filtration costs have not changed dramatically. The current opinion of probable construction cost is \$8.23 M, with an estimated total project cost of \$9.47 M.

7.3 Projected Operating Costs

Annual operating cost to produce an average of 1.5 million gallons per day of purified reclaimed water is estimated at about \$667,000 for power, chemicals, labor and equipment replacement. The detailed estimates for these costs are included in **Appendix A**.

7.4 Resulting Cost Savings

A. Raw Water Pumping

Water reclaimed in Big Spring and pumped to the District's Base 5 storage facility north of Big Spring will replace water which would otherwise be

pumped from Lake Spence through the 42" Spence Pipeline. Lake Spence water is lifted through the Spence, Spade and Moss Creek pump stations to the Base 5 facility. From there it can be directed to the City of Big Spring, to Lake J.B. Thomas or west to the Odessa area. Due to the long distance and elevation difference, the pumping cost for this source is significant, averaging about \$0.29 per 1000 gallons, based on an assumed electric rate of \$0.07 per kW-hr. With a projected reclamation of 552 million gallons per year, this equates to an annual savings of \$ 160,080.

B. Diverted Water Pumping

The District has operated the Beals Creek Pump Station since 1985 to divert the saline water of Beals Creek out of the Lake Spence watershed for storage in Red Draw Reservoir, for subsequent evaporation or sale to oil production interests. A significant portion of this flow results from the Big Spring WWTP effluent discharge. By reclaiming the effluent, a corresponding reduction in stream flow will result, and the pumping requirement will be reduced accordingly. Based on flow records from October 2004 through September 2006, and an assumed electric rate of \$0.07 per kW-hr, the District should realize diversion pumping savings of almost \$0.05 for each 1000 gallons reclaimed. With a projected reclamation of 552 million gallons per year, this equates to an annual savings of \$ 27,600.

7.5 Net Cost of Water Reclaimed

Projected operating costs are based on producing about 90% of the reclamation plant's finished product capacity, or about 552 million gallons per year. Considering capital cost debt service for 20 years at an interest rate of 5%, the resulting water cost is estimated at \$2.59 per 1000 gallons. Depending on the basis of comparison, the energy savings for raw water and diverted water pumping may be subtracted from this value.

7.6 Comparison to Alternate Sources

Three potential sources of additional water supply (Lake Alan Henry, Hovey Trough Ground Water, and Roberts County Ground Water) were considered to provide benchmarks for comparison to the projected cost of reclaimed water. Previous conceptual estimates for these sources were provided by the District, and were updated for this report to provide a similar basis for comparison. The water costs were estimated by considering a capital cost debt service for 20 years at an interest rate of 5% and an assumed electric rate of \$0.07 per kW-hr. The assumptions used to estimate these costs are shown in Appendix B.

A. Lake Alan Henry

The Alan Henry Pipeline project is estimated to supply 24 MGD for eight months per year from Lake Alan Henry to Lake Thomas. The total capital cost including 27 miles of pipelines and two pump stations (16700 gpm each) is estimated to be \$ 50 M. The annual operations and maintenance cost is estimated to be \$ 11.7 M for power, labor and an assumed royalty rate of \$1.80 per 1000 gallons. The resulting water cost is estimated at \$2.69 per 1000 gallons.

B. Hovey Trough Ground Water

Project developers of the Hovey Trough groundwater in the Pecos area have estimated there are approximately 720,000 acre-ft of water reserves under 300 square miles. This project is estimated to supply 40 MGD for six months per year for 30 years. A total of 32 wells are assumed, with an estimated average yield of 1000 gpm. Three pump stations (28,000 gpm each) are expected to pump 40 MGD from the well field to the terminal. The total capital cost is estimated at \$ 362 M, inclusive of 94 miles of pipelines, 32 wells and three pump stations. The annual operations and maintenance cost is estimated to be \$ 3M, for power and labor. The resulting water cost is estimated at \$4.46 per 1000 gallons.

C. Roberts County Ground Water

A study conducted by Mesa Water, Inc proposed that Roberts County ground water reserves supply 150,000 acre-ft/year for CRMWD and an additional 50,000 acre-ft/year to the City of Lubbock. However, this much additional is not practical for the District's needs, so a reduced project has been estimated to provide a more realistic estimate of the cost. The revised estimate is for 50,000 acre-ft/year each for CRMWD and Lubbock, or about 47 MGD each. The total capital cost is estimated at \$ 1,079 M, including 307 miles of pipelines, three pump stations and estimated costs for the well field. The annual operations and maintenance cost is estimated to be \$ 13.1 M for power and labor. The District will bear 50% of the cost of those facilities that are common to both Lubbock and CRMWD and 100% of the cost of those facilities that are dedicated to CRMWD. CRMWD's share of the capital cost is estimated to be \$ 666 M and the annual operations and maintenance cost is estimated to be \$ 6.9 M. The resulting water cost to the District is estimated at \$3.71 per 1000 gallons.

D. Cost Comparison of Sources

Table 7.1 provides a summary of estimated costs for water reclaimed from the Big Spring project in comparison to other potential supplies which may be available to the District.

Table 7.1 Summary of Cost Comparison of Sources

	Big Spring Reclamation Plant	Lake Alan Henry	Hovey Trough Ground Water	Roberts County Ground Water*
Planned Usage, million gal/yr	552	5,832	7,200	16,297
Total Capital Cost	\$ 9,469,000	\$ 50,031,000	\$ 362,278,000	\$ 666,868,539
Debt Service	\$ 759,817	\$ 4,014,617	\$ 29,070,124	\$ 53,511,260
O & M Cost	\$ 667,000	\$ 11,671,000	\$ 3,053,430	\$ 6,890,470
Annual Cost	\$ 1,426,817	\$ 15,685,617	\$ 32,123,554	\$ 60,401,730
Water Cost, (\$__ per 1000 gal)	\$ 2.59	\$ 2.69	\$4.46	\$3.71
Annual Diverted Water Savings, (\$__ per 1000 gal)	\$ 0.05			
Annual Raw Water Savings, (\$__ per 1000 gal)	\$ 0.29			
Net Annual Cost, (\$__ per 1000 gal)	\$ 2.25			

* CRMWD Share

8.0 ENERGY ISSUES

8.1 Projected Energy Requirements

One disadvantage of the proposed treatment regimen is the electrical energy required for the selected processes. Although the reuse of water which has already been pumped up to a population center saves in system pumping power, the energy for treatment is significant. Total power consumption at the treatment facility, including membrane filtration, reverse osmosis, advanced oxidation and product water pumping, is estimated to be about 2.24 million kW-hrs. per year. Some fortunate characteristics of this use are its concentration at one location and a relatively stable usage pattern, without large spikes in power demand. Both these factors are beneficial when considering the of alternative energy sources.

8.2 Alternative Energy Concepts

Renewable energy is power that comes from renewable resources such as the sun and wind. These resources are constantly replenished by nature and are a cleaner source of energy, producing no hydrocarbon emissions or greenhouse gases. Another source of renewable energy is methane produced from waste material. Although use of methane does result in emissions, the methane itself is a greenhouse gas which would otherwise enter the atmosphere, so the net effect is still very favorable compared to the use of oil, coal or natural gas. Adding more renewable energy means cleaner air and a more stable energy supply for the future.

A key concept in considering alternative energy sources is the location where alternative power is introduced and the share of power to be provided. True independent power production must be sized to meet the peak demand of the facility or equipment to be powered. When less power is required, the generation facilities must sit idle or surplus power can be sold to the commercial electric grid at a fraction of its retail value. In contrast, supplemental power is sized to meet demands consistently required, and power beyond the local generation capacity is purchased conventionally from an electric utility.

8.3 Methane Gas Capture

Methane is produced when organic matter decomposes anaerobically or ferments. Methane can be captured and used to produce energy by burning the gas in many different ways. Methane is a potent greenhouse gas that is thought to contribute to global climatic change when released into the atmosphere. It has 21 times more deleterious effect than that of carbon dioxide. Reducing emissions by capturing the gas and using it as an energy source can yield substantial energy, economic, and environmental benefits. By using methane gas to produce energy, projects can directly reduce greenhouse gas emissions and air pollutants, leading to improved local air quality. Power generation from methane indirectly reduces air pollution by offsetting the use of fossil fuels, thus reducing the emissions of carbon dioxide, sulfur dioxide, nitrogen oxides, and other pollutants resulting from fossil fuel combustion. This renewable energy source is reliable and helps create energy independence and possible cost savings. Because of their proximity to the proposed reclamation treatment facility, two methane sources have been considered as potential energy sources for the facility. These sources, the Big Spring municipal solid waste landfill and the biosolids digester at the Big Spring WWTP, are each discussed below.

A. Big Spring Landfill

Landfill gas is the natural by-product of the bacterial decomposition of solid waste in landfills and is typically comprised of roughly 60% methane and 40% carbon dioxide and small amounts of nitrogen, oxygen, and hydrogen and trace amounts of inorganic compounds. Landfills are one of the largest anthropogenic sources of methane. However, landfill gas can be an asset due to its medium heating value (350 to 600 Btu/ cu.ft.), which is about half as that of natural gas, as it is can be used as a reliable and renewable energy source to generate electricity or heat.

The gas produced during decomposition of the municipal solid waste is partially trapped by the landfill cover material. A collection system as shown

in **Figure 8.1** comprising a series of wells drilled into the landfill collects the gases through pipes. The gases are then pumped to a processing plant where they are burned in an internal combustion engine or micro-turbine coupled to a generator to create electricity as shown in **Figure 8.2**.

Figure 8.1 Landfill Gas Well (Courtesy: EPA)

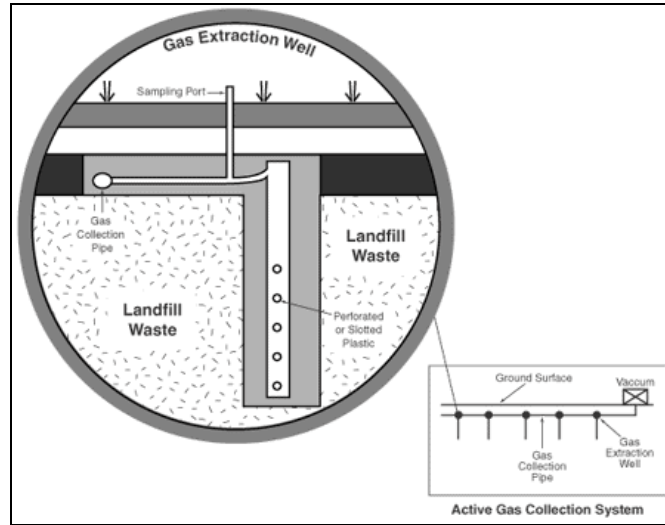
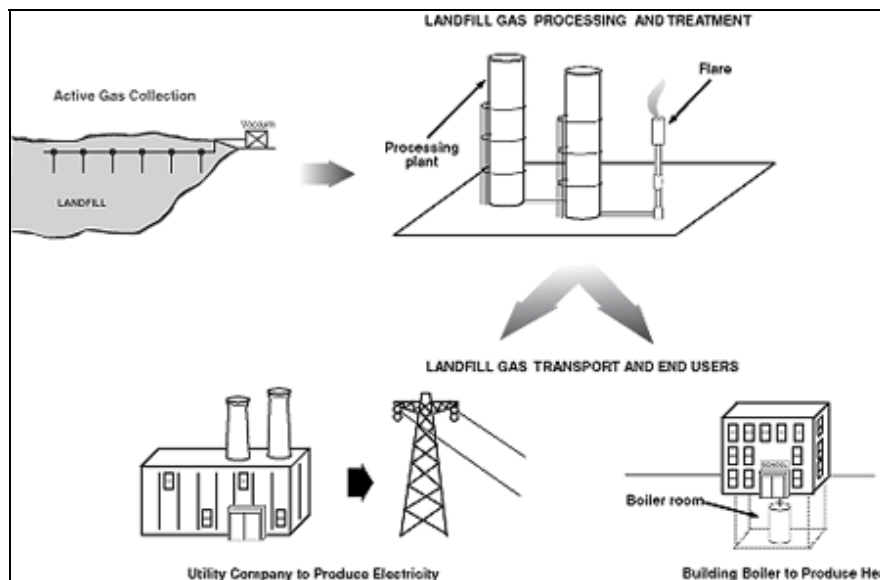

Figure 8.2 Landfill Gas Systems (Courtesy: EPA)



When it is economically viable, energy recovery from methane is of considerable benefit to the environment due to reduction in emissions. In

order to evaluate the quantity of methane gas produced in a landfill, the factors that need to be considered are the type and age of the landfill waste, the quantity and types of organic compounds in the waste, the moisture content and temperature of the waste.

The City of Big Spring has been approached about landfill waste-to-energy facilities before, but a formal study has not been followed through. Waste is baled before placement in the landfill and with arid conditions in Big Spring, the quantity of methane produced will be modest. Although it is doubtful this will be a cost-effective energy source, further feasibility studies could provide some approximate numbers for consideration and future reference.

The Big Spring landfill receives 110 tons per day of material, and has a total of 1.7 million cubic yards stored. The landfill was opened in the 1970s, and has an expected closure date of 2030. The city performs required monitoring, but only one of the sample wells produces significant methane values, and it is not enough to require flaring. The installation of a new collection system would be an additional expense required to avail the potential use of landfill gas as an alternate energy source. The capital and installation cost of the collection system is estimated to be approximately \$1,000,000 to \$2,000,000.

Even though the landfill is located close to the proposed reclamation facility site, due to the reasons mentioned above, a landfill waste-to-energy facility does not appear economically feasible under current conditions.

B. Big Spring WWTP Anaerobic Digester

Anaerobic digestion is a process in which bacteria digest residual solids in the absence of oxygen and create methane gas as a byproduct. Wastewater treatment plants (WWTPs) with anaerobic digesters can produce high quality methane with reasonable heating values that can be used as an energy source to generate heat and/or electricity. The gases that are generated from wastewater treatment plants have BTU content ranging around 550-650

BTU/cf which make them a valuable source of renewable energy for the facility's use or resale to the electric grid. A majority of the WWTPs that employ anaerobic digestion use a portion of the gas to supply heat needed to complete the digestion process. A few utilize the digester gas to produce electricity. Most of these plants could produce power from the gas and still heat their digesters with the waste heat from the generation process.

The gases (CH₄, NO_x, SO_x, H₂S, CO, CO₂, etc.) produced by anaerobic digestion consist usually of more than 60 percent methane. The gases are produced on a continuous basis and contaminants, such as hydrogen sulfide, are removed prior to use. Other processing may include dehydration, filtering or carbon dioxide removal. A Methane Gas Recovery system is used to recover valuable waste or vented gases that can be processed to provide fuel for an onsite power generation plant. One of the waste-to-energy technologies involves an internal combustion engine that runs a generator to produce electricity. Microturbines can be also be used to produce electricity.

The electricity generated by these applications can be used to power internal operations, with the excess being sold back to the grid. Another advantage of using a waste-to-energy system is the significant reduction of the WWTP facility's emissions. Apart from the environmental benefits of reduction in greenhouse gas emissions, this energy source helps in possible cost savings and also provides energy independence and security. When the gas is piped directly to its end use, it provides security from interruptions in gas and electric grids.

The Big Spring WWTP employs anaerobic digestion and the digester gas produced is currently flared and is not used for digester heating or other purposes. As the City is open to CRMWD's use of the digester gas, the methane produced by the anaerobic digestion could be a possible source of energy. Further chromatograph fuel /gas analysis on the composition,

quantity, and heating values of the digester gas produced at Big Spring would help determine if this is an economically viable option.

8.4 Solar Energy

Solar energy can be used to generate electricity using solar cells. Solar cells are also called photovoltaic cells (PV cells). As shown in **Figure 8.3** PV solar systems consist of modular panels made of silicon, which react directly to sunlight by generating electric current. An inverter changes the DC (direct current) generated by the panels into AC (alternating current), supplying power for lights and electrical appliances.

Figure 8.3 PV Cell

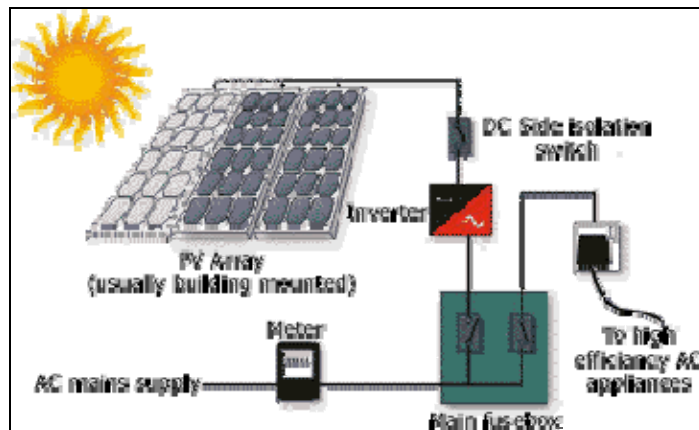

The PV systems can connect to the local utility grid so that the utility provides the power at night and on rainy days. On sunny days, the PV solar system sends surplus energy to the grid for credit. Solar panels operate with little to no maintenance except to spray dust off during dry periods, (although long-term durability may still be somewhat unproven). When combined with a utility grid, they reliably provide energy in an environmentally friendly manner.

The City of Big Spring lies in the 22,000 KW-hr/Sq.m./hour solar resource band as shown in **Figure 8.4** which makes solar power a viable alternate energy source.

Figure 8.4 Solar Resource Potential (Courtesy: Texas Environmental Center)

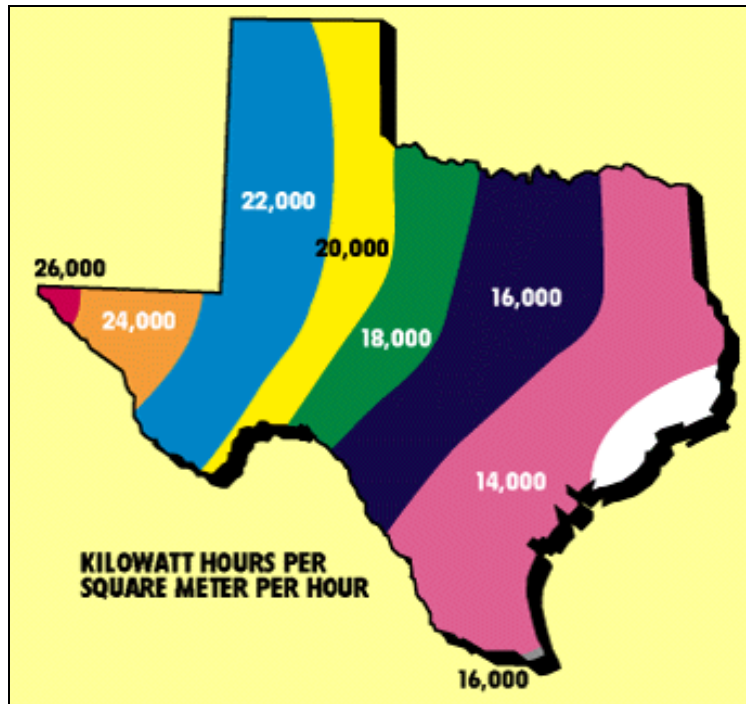

Optimum payback on alternative energy is likely to occur by using the alternative source as a supplemental source as described in Section 8.2. For preliminary consideration, a supplemental system with capacity approximately 20% of the estimated power requirement for the facility is assumed. The approximate cost of installing PV cells that generate 450,000 kW-hr of power is \$ 1,270,000 (Source: North Texas Renewable Energy Inc). This provides an annual saving of \$31,500 at a \$0.07/kW-hr rate. However, debt service on the solar system would be approximately \$102,000/year, based on a 20 year term and 5% interest. Therefore, it does not appear that current solar technology would be economically attractive.

8.5 Wind Energy

Wind energy is the fastest growing source of renewable energy and it serves well as an auxiliary and supplemental power source for water/wastewater treatment plants. The kinetic energy of the wind can be changed into other forms of energy,

either mechanical energy or electrical energy. The most common wind turbine is a horizontal-axis wind turbine that typically has three blades and is operated with the blades facing the wind. As shown in **Figure 8.5**, the blades of the turbine are attached to a hub that is mounted on a turning shaft. Blowing wind rotates the blades which in turn spin the shaft. The shaft goes through a gear transmission box where the turning speed is increased. The gears increase the rotational speeds from 30 to 60 rpm in the low speed shaft to about 1,200 to 1500 rpm in the high speed shaft. The rotational energy produced by the shaft spins the copper coils within a magnet housed in the generator. The magnet excites the electrons in the wire, producing electricity. If the wind gets too high, the turbine has a brake that will keep the blades from turning too fast and being damaged.

Figure 8.5 Wind Turbine

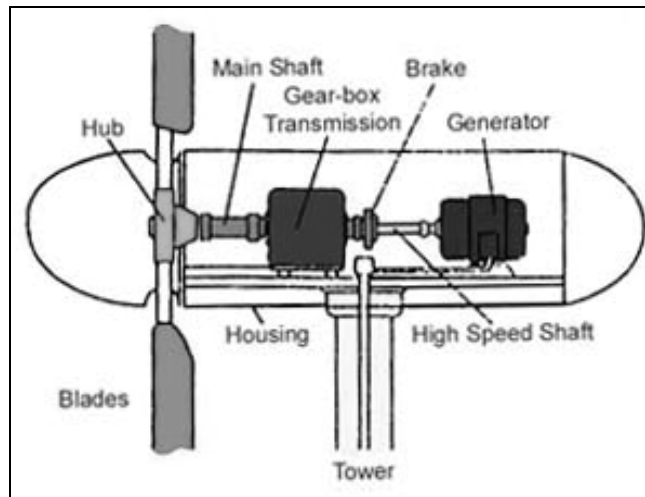

In a suitable environment, a properly sized wind turbine installed “Behind the Meter” can offset a significant portion of the operation’s energy bill. Wind turbines operate automatically with little to no maintenance and reliably provide energy in a cost-competitive, environmentally friendly manner.

Wind turbines’ power output is variable due to the fluctuation in wind speed; so they must be coupled with an energy storage device or alternate power supply. The use of control systems can also help the variability. A computer operated yaw

drive controls the blades such that the turbines always face into the wind as the wind direction changes.

The City of Big Spring lies in the Class 3 Wind Resource area as shown in **Figure 8.6**.

Figure 8.6 Wind Resources (Courtesy: Texas Environmental Center – TEC)

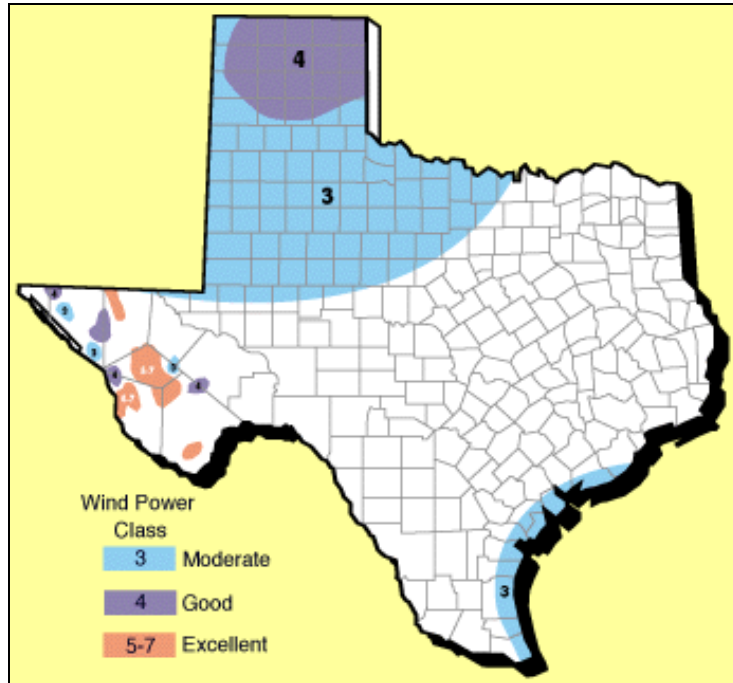

Class 3 areas have moderate winds where distributed wind technology is especially attractive over utility wind technology. Distributed energy refers to small, modular power-generating technologies that can be located at or near the location where the energy is used. They offer price stability and match well with local loads and integrate easily into an operation and within the community.

A set of three wind turbines with a small foot print (50 ft diameter blades) could offset approximately 450,000 KW-hr (20%) of the total annual power consumption thereby providing an annual saving of \$31,500 at a \$0.07/kw-hr rate. The capital and installation cost involved in setting up three wind turbines of this magnitude is approximately \$375,500 (Source: Entegri Wind Systems). Debt

service on the system would be approximately \$30,000/year, based on a 20 year term and 5% interest. Therefore, under the assumed conditions, a supplemental wind power system would provide modest savings in energy cost. If energy costs were to escalate dramatically, the savings would increase accordingly.

9.0 IMPLEMENTATION PLAN

9.1 Membrane Pilot Testing

Membrane treatment is subject to site-specific conditions which hinder design based on laboratory analysis alone. Therefore, standard practice includes a period of pilot testing to determine the reliable flow capacity of the membranes with the actual source water, to determine the fouling tendencies, and test strategies for chemical addition, cleaning regimens, and other factors to be considered in the design of the system.

Pilot testing is the next critical step in implementing the Big Spring Water Reclamation System. The testing should include each vendor who will bid for supply of the membrane treatment equipment and should be accomplished in a controlled setting to ensure each equipment team is starting with the same water quality and conditions. Prequalification of vendors is recommended to limit the cost of testing and keep the logistics manageable. It is recommended that planning for the pilot testing phase begin immediately to allow the project to continue forward.

9.2 Concentrate Discharge Permit

Another critical implementation step is obtaining a discharge permit for the reverse osmosis concentrate (reject). The permitting process requires an extended and somewhat unpredictable time frame up to a year or more. Although more refined estimates of the concentrate quality will be available following pilot testing, TCEQ staff has indicated the permit application may be submitted with estimated quality information, and supplemental data can be provided when it is available, but are unlikely to cause significant changes in the permit conditions.

9.3 Regulatory Approval

The primary regulatory activity will be the concentrate discharge permit noted above. However, there are several additional steps which will be required, and it must also be acknowledged that the proposed project represents a new step in

water reclamation, and will be subject to additional scrutiny as a result. This scrutiny is best managed by proactively supplying information to the TCEQ at key milestones and providing ongoing assurances that public health protection will be foremost in the execution of the project.

Additional regulatory steps include the following:

A. Reclaimed Water Use Authorization

Use of reclaimed water requires authorization from the TCEQ in accordance with Chapter 210 of the Texas Water Code. For the proposed project, they have indicated the authorization request should come from the City of Big Spring as the reclaimed water provider, with CRMWD as the reclaimed water user. Following the proposed treatment by the District, they will no longer consider the water to be reclaimed water, so no additional authorization is required under Chapter 210.

B. Reclaimed Water Treatment and Blending

The proposed blending of purified reclaimed water with other raw water supplies is not directly addressed by the Texas Water Code. However, under the general oversight of drinking water supplies assigned to the TCEQ, the TCEQ Drinking Water Section has requested the opportunity to review the pilot testing protocol and the plans and specifications for the treatment facility.

C. Filter Backwash Return

Section 5.6A described handling of the backwash flow from the membrane filtration equipment. The stream returned to the wastewater treatment plant will represent a significant additional flow, although no adverse consequences are anticipated. Most systems are prepared to evaluate significant new wastewater flows through the industrial pretreatment program. Although the

proposed facility is not a typical industry, this framework would allow the City of Big Spring to evaluate the flow and characteristics to confirm its compatibility.

D. Facility Construction

Typical of pipeline construction projects, there will be permitting required for specific elements such as Corps of Engineers permits for stream crossings and the concentrate discharge outfall to Beals Creek, highway crossing permits from TXDOT, Howard County, etc. These will require identification and processing as the design progresses.

9.4 Public Education

The District has already been active in promoting public awareness of drought issues and the potential to use reclaimed water as a supplemental source. The regional water reclamation project kickoff meeting was conducted in August 2004 and an outline of the proposed projects was presented to the stakeholders. The public education strategy for water reclamation implementation was developed with CRMWD in June 2005. A public meeting was conducted in July 2005 to present the conceptual reclamation projects and provide opportunities for public comment and questions. A considerable amount of media coverage on the project was also arranged. In order to provide additional opportunities for public education and comment, another public meeting was conducted in October 2007 to present the preliminary design information on the Big Spring regional water reclamation project. Agendas and minutes from the public meetings are included in Appendix D.

9.5 Land Acquisition

Land acquisition needs will include a site for the treatment facility and related storage and pumping, and easement for the reclaimed water pipeline. The proposed plant site between the Big Spring WWTP and F.M. 700 appears to be available from the City of Big Spring and should work well for the project.

Pipeline easements do not appear to present a major obstacle, but should be pursued in a timely manner to prevent any related surprises.

9.6 Potential Funding Assistance

The major source of federal funding for water reuse projects historically has been the Title XVI program administered by the U.S. Bureau of Reclamation. More recently the USBR has reduced its participation in reuse projects and is not encouraging the use of federal funds for project assistance. There have been several bills filed in the past few years for federal assistance for desalination, but to date none have been passed by Congress. Most of these are in the form of energy or other operating subsidies rather than construction grants. If a program of this type is passed, it seems likely that the proposed Big Spring Reclamation project should qualify since desalination is an integral part of the project.

State funding assistance may be available through Texas Water Development Board, either as a partial grant or as a low-interest loan. Most grant funds are for planning assistance, such as the current study for which this report is prepared. Low interest loan funds should be available through either the Clean Water State Revolving Fund (SRF) or the Drinking Water SRF since this project involves both wastewater effluent and water supply.

Additionally, local industries have expressed interest in using some of the reclaimed water and may be willing to participate in the capital funding of the project.

9.7 Proposed Project Schedule

A proposed project schedule is attached as **Figure 9.1**.

REGIONAL WATER RECLAMATION PROJECT PROPOSED BIG SPRING IMPLEMENTATION SCHEDULE

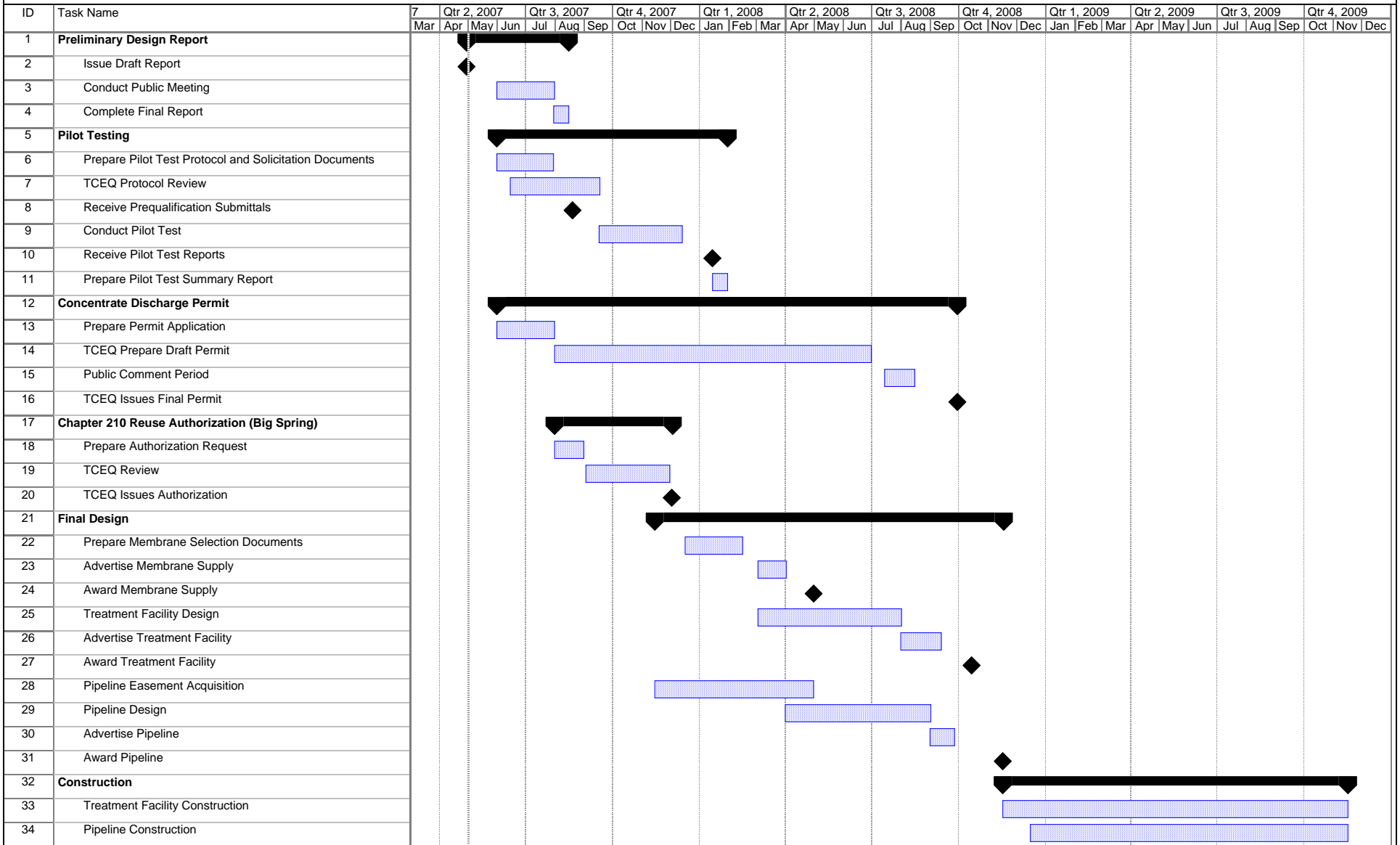

Appendix A: Cost Estimates for Reclaimed Water



Simon W. Freese, P.E. 1900-1990
Marvin C. Nichols, P.E. 1896-1969

Title: Colorado River Municipal Water District
Regional Water Reclamation Project
Big Spring

Date: Jun. 25, 2007
By: PD
Chkd: DWS

	QTY	UNIT	UNIT PRICE	TOTAL
Capital Cost				
Land Acquisition				
<i>Total Land Acquisition</i>	2.0	ac	\$ 2,000.00	\$ 4,000.00
Treatment Equipment				
Microfiltration/Ultrafiltration (MF/UF) (2.1 MGD)	1	L.S.	\$ 1,165,500.00	\$ 1,165,500.00
Reverse Osmosis (RO) (1.68 MGD)	1	L.S.	\$ 1,864,800.00	\$ 1,864,800.00
UV/Oxidation	1	L.S.	\$ 425,000.00	\$ 425,000.00
<i>Total Treatment Equipment</i>				\$ 3,455,300.00
Diversion Structure & Pump Station				
Pump Station (3-900 gpm) @ 50 ft head	1	L.S.	\$ 60,000.00	\$ 60,000.00
<i>Total Pump Station</i>				\$ 60,000.00
Pump Station (to CRMWD Raw Water Line)				
Pump Station (2-1200 gpm) @ 165 ft head	1	L.S.	\$ 50,000.00	\$ 50,000.00
.75 MG Concrete Storage Facility (30' SWD)	1	L.S.	\$ 400,000.00	\$ 400,000.00
.5 MG Glass lined steel Storage Facility (30' SWD)	1	L.S.	\$ 425,000.00	\$ 425,000.00
<i>Total Pump Station</i>				\$ 875,000.00
Reject Facilities				
High Pressure Membrane Reject (Piping to Creek) 0.21 MG RO Reject Lagoon (1/2 day of storage (0.05 ac))	1	L.S.	\$ 85,000.00	\$ 85,000.00
Low Pressure Membrane Reject 0.21 MG MF/UF Reject Lagoon (1 day storage(.05 ac))	1	L.S.	\$ 85,000.00	\$ 85,000.00
<i>Total Reject Facilities</i>				\$ 170,000.00
Pipeline (Transmission)				
12" Dia. Pipeline (4 MGD from WWTP)	1,660	L.F.	\$ 72.00	\$ 119,520.00
10" Dia. Pipeline (1.68 MGD to CRMWD Pipeline)	6,400	L.F.	\$ 60.00	\$ 384,000.00
6" Dia. Pipeline (0.42 MGD to WWTP Outfall)	1,000	L.F.	\$ 36.00	\$ 36,000.00
400' bore at IH-20, 250' bores at FM 700	650	L.F.	\$ 200.00	\$ 130,000.00
Connection at Spence Pipeline	1	L.S.	\$ 25,000.00	\$ 25,000.00
Easement	5.10	acre	\$ 1,000.00	\$ 5,096.40
<i>Total Pipeline (Transmission)</i>				\$ 699,616.40
Building				
Metal Building	5,000	S.F.	\$ 90.00	\$ 450,000.00
<i>Total Building</i>				\$ 450,000.00
Electrical				
<i>Total Electrical: 15% of Equipment Cost</i>				\$ 523,845.00
Instrumentation				
<i>Total Instrumentation: 10% of Equipment Cost</i>				\$ 349,230.00
Subtotal				\$ 6,587,000.00
Contingency (25%)				\$ 1,646,750.00
TOTAL CONSTRUCTION COST				\$ 8,233,750.00
Engineering & Construction Services (15%)				\$ 1,235,070.00
TOTAL CAPITAL COST				\$ 9,469,000.00



Simon W. Freese, P.E. 1900-1990
Marvin C. Nichols, P.E. 1896-1969

Title: Colorado River Municipal Water District
Regional Water Reclamation Project
Big Spring

Date: Jun. 25, 2007
By: PD
Chkd: DWS

	QTY	UNIT	UNIT PRICE	TOTAL
Annual Operation and Maintenance Cost				
Treatment				
MF/UF				
power consumption (kw-hr/ gal)	1,890,000	gal/day	\$0.038 / 1000 gal	\$ 26,214.30
membrane replacement	1,890,000	gal/day	\$0.030 / 1000 gal	\$ 20,695.50
chemicals (\$ / gal)	1,890,000	gal/day	\$0.045 / 1000 gal	\$ 31,043.25
RO				
power consumption (kw-hr/ gal)	1,520,000	gal/day	\$0.140 / 1000 gal	\$ 77,672.00
membrane replacement	1,520,000	gal/day	\$0.080 / 1000 gal	\$ 44,384.00
cartridge filters	1,520,000	gal/day	\$0.030 / 1000 gal	\$ 16,644.00
chemicals (\$ / gal)	1,520,000	gal/day	\$0.200 / 1000 gal	\$ 110,960.00
UV				
power consumption & lamp replacement	1,520,000	gal/day	\$0.05 / 1000 gal	\$ 25,890.67
chemicals (\$ / gal)	1,520,000	gal/day	\$0.005 / 1000 gal	\$ 2,774.00
<i>Total Treatment</i>				\$ 356,277.72
Labor				
1 part time employee (28 hours per week)	1,456	Hrs.	\$ 26.50	\$ 38,584.00
<i>Total Labor</i>				\$ 38,584.00
Pumping (Transmission)				
Pumping to Rec. Treatment Facility (power cost)	141,366.10	kW-hr	\$0.07 / kw-hr	\$ 9,895.63
Pumping to CRMWD raw water pipeline (power cost)	373,206.51	kW-hr	\$0.07 / kw-hr	\$ 26,124.46
<i>Total Pumping (Transmission)</i>				\$ 36,020.08
Annual Maintenance				
<i>Total Annual Maintenance (5% of Equipment Cost)</i>				\$ 174,615.00

Subtotal **\$ 605,500.00**

Contingency (10%) **\$ 60,550.00**

TOTAL ANNUAL OPERATION AND MAINTENANCE COST **\$ 667,000.00**

Raw Effluent Capacity (MGD)	2.10
Finished Product Capacity (MGD)	1.68
Assumed Utilization	90%
Annual Volume (Kgal/yr)	551,880
20 years 0.05 Debt Service	\$759,817.06
Total Annual	\$ 1,426,817.06
Cost per 1000 gal.	\$ 2.59

Appendix B: Cost Estimates for Alternate Sources



Simon W. Freese, P.E. 1900-1990
Marvin C. Nichols, P.E. 1896-1969

Title: Colorado River Municipal Water District
Cost Estimation: Lake Alan Henry to Lake Thomas
24 MGD capacity operated 8 months per year

Date: Jun. 20, 2007
By: PD
Chkd: DWS

	QTY	UNIT	UNIT PRICE	TOTAL
Capital Cost				
Land Acquisition				
Land (for 1-Pump Station)	2		\$ 4,000.00	\$ 8,000.00
Land (Pipeline ROW in Roads @ \$10/Rod)	8,486		\$ 10.00	\$ 84,860.00
<i>Total Land Acquisition</i>				\$ 92,860.00
Pump Station				
Pump Station (16667 gpm) @ 335 ft head	2	L.S.	\$ 2,750,000.00	\$ 5,500,000.00
<i>Total Pump Station</i>				\$ 5,500,000.00
Pipeline (Transmission)				
33" Dia. Pipeline	56,972	L.F.	\$ 182.00	\$ 10,368,904.00
39" Dia. Pipeline	83,054	L.F.	\$ 215.00	\$ 17,856,610.00
33" Valve	2		\$ 18,000.00	\$ 36,000.00
39" Valve	2		\$ 24,000.00	\$ 48,000.00
<i>Total Pipeline (Transmission)</i>				\$ 28,309,514.00
Electrical & Instrumentation				
<i>Commication Cable</i>	140,026		\$ 0.58	\$ 81,215.08
<i>Elect. Sub Station</i>	2		\$ 400,000.00	\$ 800,000.00
<i>SCADA</i>	2		\$ 10,000.00	\$ 20,000.00
				\$ 901,215.08
Subtotal				\$ 34,803,590.00
Contingency (25%)				\$ 8,700,900.00
Engineering & Construction Services (15%)				\$ 6,525,680.00
TOTAL CAPITAL COST				\$ 50,031,000.00

	QTY	UNIT	UNIT PRICE	TOTAL
Annual Operation and Maintenance Cost				
Labor				
<i>Total Labor</i>				\$ 58,080.00
Electricity : Pumping (Transmission)				
<i>Total Pumping (Transmission)</i>				\$ 1,114,708.00
Royalty				
<i>\$1.80 per Kgal (24 MGD capacity operated 8 months/yr)</i>	24,000		\$ 1.80	\$ 10,497,600.00
TOTAL ANNUAL OPERATION AND MAINTENANCE COST (excluding debt service)				\$ 11,671,000.00
20 years 0.05 Debt Service				\$4,014,616.88
TOTAL ANNUAL OPERATION AND MAINTENANCE COST (including debt service)				\$ 15,685,616.88
Annual Volume (Kgal/yr) - 24 MGD for 8 months per year				5,832,000 Kgal/yr
Cost per 1000 gal.				\$ 2.69



Simon W. Freese, P.E. 1900-1990
Marvin C. Nichols, P.E. 1896-1969

Title: Colorado River Municipal Water District
Cost Estimation: Hovey Trough to Terminal
40 MGD design rate for 6 months of each year for 30 years

Date: Jun. 20, 2007
By: PD
Chkd: DWS

	QTY	UNIT	UNIT PRICE	TOTAL
Capital Cost				
Land Acquisition				
Land	30	L.F.	\$ 400.00	\$ 12,000.00
Land (Pipeline ROW in Roads @ \$10/Rod)	30,080		\$ 10.00	\$ 300,800.00
<i>Total Land Acquisition</i>				\$ 312,800.00
Pump Station				
Pump Station (27778 gpm) @ 462, 578, 404 ft head each	3	L.S.	\$ 4,500,000.00	\$ 13,500,000.00
<i>Total Pump Station</i>				\$ 13,500,000.00
Pipeline (Transmission)				
39" Dia. Pipeline	221,232	L.F.	\$ 214.50	\$ 47,454,264.00
45" Dia. Pipeline	275,088	L.F.	\$ 247.50	\$ 68,084,280.00
33" Valve	0		\$ 1,800.00	\$ -
39" Valve	0		\$ 6,000.00	\$ -
<i>Total Pipeline (Transmission)</i>				\$ 115,538,544.00
Electrical & Instrumentation				
<i>Commication Cable</i>	496,320		\$ 0.58	\$ 287,865.60
<i>Elect. Sub Station</i>	3		\$ 400,000.00	\$ 1,200,000.00
<i>SCADA</i>	3		\$ 10,000.00	\$ 30,000.00
				\$ 1,517,865.60

Subtotal **\$ 130,869,209.60**

Contingency (25%) **\$ 32,717,302.40**

Total Hovey Trough - Well Field to Junction - including contingency (excluding engg & construction services) **\$ 163,586,512.00**

(40 MGD - 39/45" Pipeline - 94 miles)

Total Hovey Trough - Well Field - including contingency (excluding engg & construction services) **\$ 151,437,824.00**

(46 MGD Production - 32 Wells @ 1000 gpm avg)

Engineering & Construction Services (15%) **\$ 47,253,660.00**

TOTAL CAPITAL COST **\$ 362,278,000.00**

	QTY	UNIT	UNIT PRICE	TOTAL
Annual Operation and Maintenance Cost				
Labor				
<i>Total Labor</i>				\$ 88,000.00
Electricity : Pumping (Transmission)				
<i>Total Pumping (Transmission)</i>				\$ 2,965,422.00

TOTAL ANNUAL OPERATION AND MAINTENANCE COST (excluding debt service) **\$ 3,053,430.00**

20 years 0.05 **Debt Service** **\$29,070,124.00**

TOTAL ANNUAL OPERATION AND MAINTENANCE COST (including debt service) **\$ 32,123,554.00**

Annual Volume (Kgal/yr) - 40 MGD for 6 months per year **7,200,000**

Cost per 1000 gal. **\$ 4.46**



Simon W. Freese, P.E. 1900-1990
Marvin C. Nichols, P.E. 1896-1969

Title: Colorado River Municipal Water District - Alternate Sources Estimates
Cost Estimation: Roberts County
47 MGD (approx) capacity per year

Date: Jun. 20, 2007
By: PD
Chkd: DWS

				QTY	UNIT	UNIT PRICE	TOTAL
Capital Cost - Shared							
Pump Station							
Pump Station (65278 gpm) @ 625 ft head each		2	L.S.	\$ 10,750,000.00		\$	21,500,000.00
<i>Total Pump Station</i>							\$ 21,500,000.00
Pipeline (Transmission)							
72" Dia. Pipeline		1,045,440	L.F.	\$ 396.00		\$	413,994,240.00
<i>Total Pipeline (Transmission)</i>							\$ 413,994,240.00
Electrical & Instrumentation							
	Commication Cable	1,045,440		\$ 0.58		\$	606,355.20
	Elect. Sub Station	2		\$ 400,000.00		\$	800,000.00
	SCADA	2		\$ 10,000.00		\$	20,000.00
<i>Total</i>							\$ 1,426,355.20
Roberts County - Well Field							\$ 136,780,000.00
Subtotal							\$ 573,700,595.20
Contingency (25%)							\$ 143,425,148.80
Engineering & Construction Services (15%)							\$ 107,568,870.00
TOTAL SHARED CAPITAL COST							\$ 824,694,614.00

Capital Cost - CRMWD							
Pump Station							
Pump Station (32639 gpm) @ 140 ft head		1	L.S.	\$ 5,385,000.00		\$	5,385,000.00
<i>Total Pump Station</i>							\$ 5,385,000.00
Pipeline (Transmission)							
54" Dia. Pipeline		575,520	L.F.	\$ 297.00		\$	170,929,440.00
<i>Total Pipeline (Transmission)</i>							\$ 170,929,440.00
Electrical & Instrumentation							
	Commication Cable	575,520		\$ 0.58		\$	333,801.60
	Elect. Sub Station	1		\$ 400,000.00		\$	400,000.00
	SCADA	1		\$ 10,000.00		\$	10,000.00
<i>Total</i>							\$ 743,801.60
Subtotal							\$ 177,058,241.60
Contingency (25%)							\$ 44,264,560.40
Engineering & Construction Services (15%)							\$ 33,198,430.00
TOTAL CRMWD DEDICATED FACILITIES - CAPITAL COST							\$ 254,521,232.00
TOTAL CRMWD SHARE OF CAPITAL COST (50% OF SHARED COST + CRMWD DEDICATED FACILITIES COST)							\$ 666,868,539.00

				QTY	UNIT	UNIT PRICE	TOTAL
Annual Operation and Maintenance Cost - Shared							
Labor							
<i>Total Labor</i>							\$ 176,000.00
Electricity : Pumping (Transmission)							
<i>Total Pumping (Transmission)</i>							\$ 12,232,595.00
TOTAL SHARED ANNUAL OPERATION AND MAINTENANCE COST							\$ 12,408,600.00

Annual Operation and Maintenance Cost - CRMWD							
Electricity : Pumping (Transmission)							
<i>Total Pumping (Transmission)</i>							\$ 686,170.00
TOTAL CRMWD DEDICATED FACILITIES - ANNUAL OPERATION AND MAINTENANCE COST							\$ 686,170.00
TOTAL CRMWD SHARE OF ANNUAL OPERATIONS AND MAINTENANCE COST (50% OF SHARED COST + CRMWD DEDICATED FACILITIES COST)							\$ 6,890,470.00
20 years 5.00% Debt Service							\$ 53,511,260.00
TOTAL ANNUAL OPERATION AND MAINTENANCE COST (including debt service)							\$ 60,401,730.00
Annual Volume (Kgal/yr) - 47 MGD per year (95%)							16,297,250
Cost per 1000 gal.							\$ 3.71

Appendix C: Correspondence with State Agencies

TCEQ Meeting October 6, 2004

CRMWD Regional Water Reclamation Project
TCEQ Discussion Issues

1. Quality requirements for blending of repurified water
 - 1.1. Surface water blending in pipeline or constructed reservoir
 - 1.1.1. Pathogen limits/barriers (No. of barriers?, log reduction/inactivation?)
 - 1.1.2. Dissolved solids (TDS, chlorides, sulfates)
 - 1.1.3. Blending ratio (average/typical, maximum instantaneous)
 - 1.1.4. Other parameters (special requirements, operator certification, etc.)
 - 1.1.5. Modifications of subsequent treatment (existing WTPs)
 - 1.1.6. Permitting or authorization required
 - 1.2. Groundwater recharge for subsequent surface water blending
 - 1.3. Groundwater recharge for subsequent use with disinfection only (infiltration or injection)
2. Potable aquifer issues
 - 2.1. Allowable recharge options
 - 2.2. Water quality requirements
 - 2.3. Permitting or authorization required
 - 2.4. Protection of rights for withdrawal – rule of capture restrictions
3. Disposal aquifer issues
 - 3.1. Co-disposal permitting process for existing wells
 - 3.2. Permitting process for new wells
 - 3.3. Water quality requirements
 - 3.4. Hydrogeological requirements
4. Surface discharge issues
 - 4.1. Membrane backwash and/or desalination reject to Beals Creek
 - 4.2. Membrane backwash and/or desalination reject to Red Draw Reservoir
 - 4.3. Desalination reject to constructed evaporation pond
 - 4.4. Cooling tower blowdown to Monihans Draw



MEETING MINUTES

Project: CRMWD Water Reclamation Project **Meeting Minutes No.** 1

Subject: TCEQ Interpretations of project issues

Recorded By: David Sloan

Date: October 6, 2004

Location: TCEQ Offices, Austin

Attendees: John Grant, Chris Wingert – CRMWD
Mike Cowan, Doug Holcomb – TCEQ/Water Supply Division
Ruben Alvarado – TCEQ/Public Drinking Water
Lann Bookout – TCEQ/Water Rights
Steve Musick – TCEQ/TAD Groundwater
Robin Smith – TCEQ/Legal
Bryan Smith – TCEQ/UIC/IHW
John Burkstaller – Daniel B. Stephens & Associates
Mike Morrison, David Sloan – Freese and Nichols, Inc.

The following reflects our understanding of the items discussed during the subject meeting. If you do not notify us within five working days, we will assume that you are in agreement with our understanding.

- | Item | Description |
|-------------|---|
| 0.1 | Following introductions, John Grant gave a brief background and overview of the project. He noted the severity and long-term nature of the current drought and its impact on the District's surface water reservoirs. He noted the need to make the District's water supply more resistant to drought and to maximize the use of treated effluent for beneficial use. He also noted the aggressive time frame the District was applying to the project, to allow timely implementation if the project is deemed feasible, as they expect. |
| 0.2 | David Sloan distributed the list of issues requiring input from TCEQ staff. He noted they were grouped in four general subjects: Potable reuse requirements, potable aquifer injection/recharge, groundwater disposal, and surface discharge. It was understood that final answers may not be available on some questions, but we were seeking to understand TCEQ's approach to the issues and identify any fatal flaws for key components of the project. |
| 1. | Quality Requirements for blending of repurified water |
| 1.1 | Surface Water |
| 1.1.1 | David Sloan explained treated effluent would be collected just prior to discharge and |



transferred to the District's planned raw water processing facility for additional treatment. The processed water would then be blended with other raw water for subsequent treatment by the member and customer cities. He asked if there were any requirements for pathogen inactivation/removal, or treatment technique requirements relating to effluent intended for blending with the raw water supply. Ruben Alvarado replied the principal guidance would be that the new source must be of adequate quality so as not to hinder the ability of Surface Water Treatment Plants to comply with drinking water quality standards. This would include future rules such as the Long Term 2 Enhanced Surface Water Treatment Rule.

- 1.1.2 Dissolved constituents such as TDS, chlorides and sulfates were discussed, recognizing that the District's raw water supplies typically do not now meet secondary standards for these parameters. Mr. Alvarado indicated the new source should be of sufficient quality so that it did not deteriorate the overall water quality. For example, if a chloride concentration of 700 mg/L was provided in the raw water pipeline, neither the new source nor the resulting blend were required to meet the secondary standard of 300 mg/L, but the resulting blend should be less than or equal to the 700 mg/L of the raw water.
 - 1.1.3 David asked if there was a limit to the ratio of reclaimed and other raw water and Mr. Alvarado indicated there was not.
 - 1.1.4 David asked if there were any special requirements for operator certification, monitoring or reporting for the reclaimed water treatment facilities. Mr. Alvarado indicated the Drinking Water Section would expect to get monitoring reports of the plant operation, but there were no requirements established.
 - 1.1.5 Mr. Alvarado indicated no modification of the existing water treatment operations should be required as the result of blending the reclaimed water. The exception would be if *Cryptosporidium* sampling under the Long Term 2 rule indicated the reclaimed water to have a higher bin classification, but it was also noted that with planned membrane filtration of the effluent, the reclaimed water should have no contribution of *Cryptosporidium*.
 - 1.1.6 No permits are required for surface water blending, but plans and specifications should be submitted for review and an authorization for reclaimed water use should be obtained.
 - 1.2,3 Water injected into a potential drinking water aquifer must meet drinking water standards in accordance with Chapter 290 of the Texas Administrative Code. There is no distinction between water that undergoes subsequent treatment and water that will be used without additional treatment. David asked if there was any credit given for water quality improvement through percolation if an infiltration basin was used for recharge. No such facilities are currently used in Texas and no rules exist on their use. There are some enhanced recharge facilities, but these are typically along creeks and rivers in established recharge zones, where impoundments are made to increase natural recharge.
- 2. Potable aquifer issues**
- 2.1 Artificial recharge could be by injection or percolation, but no rules are established for percolation.
 - 2.2 For injection into a water supply aquifer, water quality must meet the better of the public drinking water standards and the existing water quality. This was interpreted to include secondary standards, although some discretion may exist on secondary standards if the

existing water quality is well above the secondary limit. Water quality for injection must be tested monthly and reported quarterly.

- 2.3,4 New aquifer storage and recovery regulations are in place within the UIC rules (Chapter 331, Subchapters H & K), though the only active ASR facility (Kerrville) was authorized prior to the regulations. El Paso's Fred Hervey injection system is not technically considered ASR because of the time in which it was implemented. (It was permitted as a wastewater discharge, with drinking water quality standards as its permit limits.) ASR requires a pilot phase to confirm that the injected water can be recovered without excessive losses, that quality is not deteriorated during storage (through mixing or dissolution), and excessive pressures are not required for injection. Control of water movement and withdrawal must also be demonstrated, including ownership of land over the affected portion of the aquifer, or legal control of withdrawals through a groundwater management district or similar measures.

A pilot phase authorization request should normally be addressed within 60 days, and does not require a new water right permit as long as the injected water is already covered by existing rights. Following the pilot study, full-scale implementation requires amendment of the surface water rights to include ASR as an allowable use. The surface water right will apply to whatever portion of the original water supply is derived from surface water; the portion originally derived from groundwater (not including ASR extraction) would be considered a groundwater transfer, not subject to the surface water right.

3. Disposal aquifer issues

Three classes of disposal wells of interest:

Class 1: Hazardous waste disposal for poor-quality aquifers with TDS >10,000 mg/L. Requires expensive casing construction to protect shallower, higher quality aquifers.

Class 2: Disposal wells for water used in the production of petroleum. Permitting is through the Railroad Commission, and does not allow co-disposal of other wastewaters. Only potential for co-disposal would be through sale and beneficial use of waste stream prior to disposal.

Class 5: Wastewater disposal wells. Typically for moderately saline aquifers with TDS <10,000 mg/L. Wastewater must be of higher quality than receiving aquifer for all parameters of interest and must not jeopardize other aquifers in the vicinity. Generally much less expensive than Class 1 well (perhaps \$100,000 vs. \$1 million). In hydrogeologically isolated regions, a Class 5 permit might be obtained for a low quality aquifer if no overlying aquifers were present.

4. Surface discharge issues

Firoj Vahora noted that waste streams from membrane treatment were considered for permitting purposes as industrial wastes, and questions should be directed to Kelly Holligan, Team Leader for Industrial Permitting (not present). Mr. Vahora indicated a permit should be obtainable for direct discharge to Beals Creek if the proposed discharge would result in compliance with the current stream standards for the segment of interest. It was noted that a high salinity discharge with groundwater recharge potential could confuse ongoing investigations of high TDS spills from the Alon Refinery area.

CRMWD Reclamation

10/6/04

<u>Name</u>	<u>Representing</u>	<u>Phone No</u>
Rolin Smith	TCEQ Legal	512 239 0463
Steve Musick	TCEQ/TAD groundwater	239-4514
Firoj Vahora	TCEQ/Municipal Team	239-4540
Doug Holcomb	TCEQ/Water Supply Div	2396947
BRYAN Smith	TCEQ/wic/ THW section	239-6075
Mike Morrison	Fresse and Nichols	817-735-7250
John Brunstaller	David B Stephens & Ass.	(505)-822-7100
JOHN GRANT	CRMWD	432-267-6341
David Sloan	EFNI	817-735-7277
Chris Wingert	CRMWD	432-267-6341
RUBEN ALVARADO	TCEQ/TADW	239 6063
Michael D. Cowan	TCE/WSD	(512) 239-4050
Lann Beckert	TCEQ/Water Rights	(512) 239-4609

**CRMWD & Big Spring Coordination
Meeting
January 30, 2007**



AGENDA
CRMWD/City of Big Spring Coordination Meeting
Big Spring Regional Water Reclamation System
January 30, 2007

1. Project Review and Status
2. Points of connection
 - a. Effluent Diversion
 - b. Filter Backwash Return
 - c. RO Concentrate (Brine) Discharge
3. Reclaim Facility Siting
 - a. Flood hazards
 - b. Corrosion/odor issues
4. Connection facility locations
 - a. Diversion Pump Station
 - b. Diversion pipeline route
 - c. Concentrate discharge pipeline route
 - d. Filter backwash return route (liquid treatment side)
 - e. Filter backwash return route (solid treatment side)
5. Plant Impacts
 - a. Effluent Flow Measurement
 - b. Dechlorination
 - c. Backwash Return
6. SCADA Interface
 - a. Communication
 - b. Big Spring Signals
 - c. CRMWD Signals
7. Pilot Testing
8. Landfill Methane Collection
9. WWTP Site Visit



MEETING MINUTES

Project: CRMWD **Meeting Minutes No. 1**
 Big Spring Regional Water Reclamation Project

Subject: CRMWD/City of Big Spring Coordination Meeting

Recorded By: Priya Dhanapal

Date: 01/30/07

Location: City of Big Spring, City Hall

Attendees: **City of Big Spring**
 Todd Darden (TD), Kenny Scott (KS)
CRMWD
 Chris Wingert (CW)
Freese and Nichols, Inc (FNI)
 David Sloan (DWS), Priya Dhanapal (PD)

Handouts: *Preliminary Site plan, Option A and B plan*

Item	Description	Action By
1.00	Project Review and Status	
	<p>Introduction/Project Description: CW introduced the meeting attendees. Everyone received the agenda.</p> <p>CW gave an overview of the results of the CRMWD regional water reclamation feasibility study. Although all three regional water reclamation projects studied were feasible, the Big Spring project is more economically attractive and has a viable outlet for the disposal of desalination concentrate at Beals Creek which is already subject to very high salinity from natural mineral sources. These key points make it desirable to proceed with the preliminary design phase of the Big Spring project.</p> <p>The proposed location of the reclamation project site was outlined. The site is generally west of the Big Spring WWTP, north of the baseball practice field.</p>	



	<p>TD noted several things about the proposed location:</p> <p><u>Flood plain.</u> The initial site plan indicates some facilities to be located within the 100-year flood plain, but by moving things south, this could probably be avoided. TD noted he was the local flood plain coordinator, so he could approve flood plain issues when it comes to that point. He also noted the baseball field is used only for practice, and could be replaced elsewhere if needed. DWS noted that an L-shaped site with access from FM 700 and 11th might facilitate chemical deliveries.</p> <p><u>Ownership.</u> TD noted all the land on the east side of FM 700 is owned by the City of Big Spring. A small area at the corner currently is leased out.</p> <p><u>Sewer conflicts.</u> TD mentioned that there are four manholes by the bridge that connect to the bar screens across this site. He will provide the plans.</p> <p><u>Corrosion.</u> CW inquired about corrosion issues and TD confirmed that the local atmosphere would attack unprotected metal, noting they had several doors at the WWTP and the animal shelter which were in need of replacement. Materials should be non-corrosive or protected by paint systems.</p> <p>TD also noted that land was likely available on the SW corner of the IH 20 – FM 700 intersection. He pointed out that routing for the reclaimed product water line would likely be easier on the west side of FM 700, as the City already has a water line and a wastewater line along the east side, and the landfill extends quite close to the highway.</p>	
2.00	Points of Connection	
a.	<p><u>Effluent Diversion:</u> DWS gave an overview of the proposed effluent flow interception options. In order to utilize the treatment capabilities of the City’s existing facility at the maximum, effluent should be diverted post chlorination and prior to dechlorination/discharge. Two options (Option A and Option B) were briefed – Option A included a submersible pump station located east of the chlorine contact basin, with a piping connection to the filter effluent channel. Option B had an alternate location of the pump station at the west of the outfall structure, with a connection in to the west wall of the dechlorination structure.</p>	



INNOVATIVE APPROACHES... PRACTICAL RESULTS

	<p>Option B: It was noted that the grates can be lifted and vertical pumps can be inserted in dechlorination chamber. However, routing the pipe lines to the newly proposed alternate reclamation facility (near the ball field) from option B did not seem advantageous compared to option A. Option B also would be affected by the location of the sulfur dioxide feed point, and therefore less desirable.</p> <p>Option A: There was a question whether the filter effluent channel was continuous or if the effluent channel from the two filters were separated by a sluice gate. The plant visit later in the day confirmed that it was a continuous channel. It was confirmed that the cross hatched area through which the RO concentrate pipeline routing is proposed in option A no longer exists. The area between the plant road and 11th is relatively clear, except for one drain line, and Option A seemed more advantageous for routing the pipelines to the newly proposed alternate reclamation facility.</p>	
<p>b.</p>	<p>Filter Backwash Return: DWS: The membrane filter backwash stream may have additional separation processes (secondary membrane stage or chemical coagulation). FNI recommends sending the backwash to the City's WWTP for subsequent handling. Depending on the concentration of the backwash, the following actions can be taken.</p> <ol style="list-style-type: none"> 1. Fairly dilute/(biodegradable): Direct the backwash to the liquid stream either at the headworks or at the relift pump station followed by aeration basin. 2. Concentrated backwash might be directed to the digester through the sludge pump station. <p>KS wanted Big Spring's engineers to check the option of returning the backwash to the WWTP. KS also wanted to know the make up of each of the streams (backwash and reject).</p> <p>DWS/CW: The make up of the stream will be determined during the pilot testing phase.</p> <p>KS also mentioned that the WAS pump station works 3-6 hours/day, with flow routed through the gravity belt thickener prior to the anaerobic digester. Also, the gravity thickener basin is offline/by-passed. Primary sludge is pumped directly from the bottom of the clarifier to the digester. After digestion, it is sent to drying beds (2-6 days) after which they are sent to the landfill.</p>	



INNOVATIVE APPROACHES... PRACTICAL RESULTS

<p>c.</p>	<p>RO concentrate: DWS recommended direct discharge to Beals Creek using a separate permit for CRMWD. The direct discharge permit issues will be discussed with TCEQ in the planned February meeting. Discharging the RO concentrate through the existing WWTP outfall structure will avoid new construction in the floodway. However, there were concerns that it may be difficult to prevent contamination of the City's effluent monitoring by the concentrate, so it may be desirable to create a separate discharge point.</p> <p>CW suggested Red Draw reservoir will remain in consideration as an alternate disposal site, but would require more pipeline expense.</p>	
<p>3.00</p>	<p>Reclaim Facility Sitting</p>	
<p>a</p>	<p>Flood hazards: Reference item 1.</p>	
<p>b</p>	<p>Corrosion and Odor Issues: Reference item 1.</p>	
<p>4.00</p>	<p>Connection Facility Locations</p>	
<p>a</p>	<p>Diversion Pump Stations: Three submersible pumps (approx. 25 hp each) with variable speeds were proposed for peak hour flows of 4-5 MGD.</p>	
<p>b</p>	<p>Diversion Pipeline Route: Reference Item #2 a.</p>	
<p>c.</p>	<p>Concentrate discharge pipeline route: Reference item #3</p>	
<p>d.</p>	<p>Filter backwash return route (liquid treatment side) Reference item #2 b</p>	
<p>e.</p>	<p>Filter backwash return route (solid treatment side) Reference item #2 b</p>	
<p>5.00</p>	<p>Plant Impacts</p>	
<p>a.</p>	<p>Effluent Flow measurement: DWS noted existing discharge flow meter would no longer indicate total plant flow, but KS replied that the outfall meter is not connected to the functions of chlorine feed, dechlorination, etc.</p>	
<p>b.</p>	<p>Dechlorination: Since the reclamation facility is expected to take all effluent most of the time, dechlorination will only be required intermittently. A warning can be set up to start dechlorination at times of discharge. KS noted this will require some additions to their controls, which are primarily manual.</p>	
<p>c.</p>	<p>Backwash Return: Reference item #4b – KS wanted to consult their engineers and also wanted to know the make up of the streams. Pilot testing results would throw light on the makeup of the streams.</p>	



6.00	SCADA Interface	
	<p>DWS: SCADA data should be collected according to their location to simplify wiring and panel layout and information should be shared between the facilities.</p> <p>KS mentioned that the SCADA system was to be set up in October 2006 but has been delayed. It is expected to start soon. (Contact person: Brian/Andrew from UMC)</p>	
7.00	Pilot Testing	
	<p>The plant visit helped determine the possible location of the Pilot testing. The old chlorine contact basin shown hatched in the plan no longer exists and seemed to be a feasible location. During the plant visit, it was noted that the current plant water pumps are to be replaced by pumps mounted directly in the outfall box, and this work should be complete within about 2 months. This might make the existing slab west of the outfall available for pilot testing if it is large enough.</p>	
8.00	Landfill Methane Collection	
	<p>The City of Big Spring has been approached about landfill waste-to-energy facilities before, but no one has followed through with a formal study. DWS explained FNI would prepare a conceptual check on feasibility to determine if a more detailed study is warranted. Waste is baled before placement in the landfill, and with arid conditions in Big Spring, the quantity of methane produced will be modest. Although it is doubtful this will be a cost-effective energy source, the study will provide some approximate numbers for consideration and future reference.</p> <p>TD estimated the landfill receives 110 tons per day of material, and has a total of 1.7 million cubic yards stored. The landfill was opened in the 1970s, and has an expected closure date of 2030. The city performs required monitoring, but only one of the sample wells produces significant methane values, and it is not enough to require flaring.</p> <p>KS noted methane was also produced by the anaerobic digester at the WWTP. The gas there is flared and is not currently used for digester heating or other purposes. The City was open to CRMWD's use of this gas if it is beneficial.</p>	
9.00	Other Concerns	
	<p>CW asked how frequently the plant experienced process upsets, how they could be recognized, and how they were handled. KS</p>	



INNOVATIVE APPROACHES... PRACTICAL RESULTS

	<p>responded that there were only two significant upsets in his extended association with the plant and in case of upsets, the city must let it run its course.</p> <p>In order to ensure that only good quality water from the WWTP is used for the reclamation facility, DWS suggested that SCADA controls can be set up for turbidity, conductivity and TOC at the filter effluent channel (i.e., at the effluent diversion point) and in case of upsets, the pumps would shut off automatically. The bad quality water can be discharged to Beals Creek. This prompted a discussion of whether such selective discharge could trigger permit violations since the better quality effluent which normally averages with such excursions would not be discharged, and therefore not averaged in with the lesser quality values. This issue will be discussed when the district and FNI meet with TCEQ soon.</p> <p>An alternate solution was to store the lower quality water in the 12 MG basin and then pump it to the head of the plant to re-treat it. The 12 MG basin would be sufficient for upsets that last several days. However, the liners on the 12 MG basin would need replacement, a significant additional expense.</p> <p>A copy of the city's current discharge permit will be provided to FNI for reference.</p>	
10.00	Other Concerns (contd.)	
	<p>Power supply. 3 phase power sufficient for pilot testing should be available at the Dechlorination Building.</p> <p>Permanent power for the effluent diversion pump station will likely require additional power capacity from the main switchgear at the relift pump station. However, it was agreed this would still be the logical way to serve the new pump station. This avoids having separate supplies in overlapping areas, with resulting safety concerns. Sub metering the power supply can provide documentation of the power used for reclamation.</p>	
	Close/Adjourn	

ACAD: Rel 17.0s (LMS Tech)
 [C:\D04249\FWCAD1] N:\WW\IMP-ALL-PL-SITE02.dwg LAYOUT: Layout1
 Jan 22, 2007 - 11:17am PSLTS: 1 TWIST: CLUAL\FRESE.COM
 REFERENCES: N:\Standard\17REPORT\BDS.dwg N:\WW\Bgsa\MP-ALL-PL-BASE.dwg

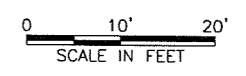
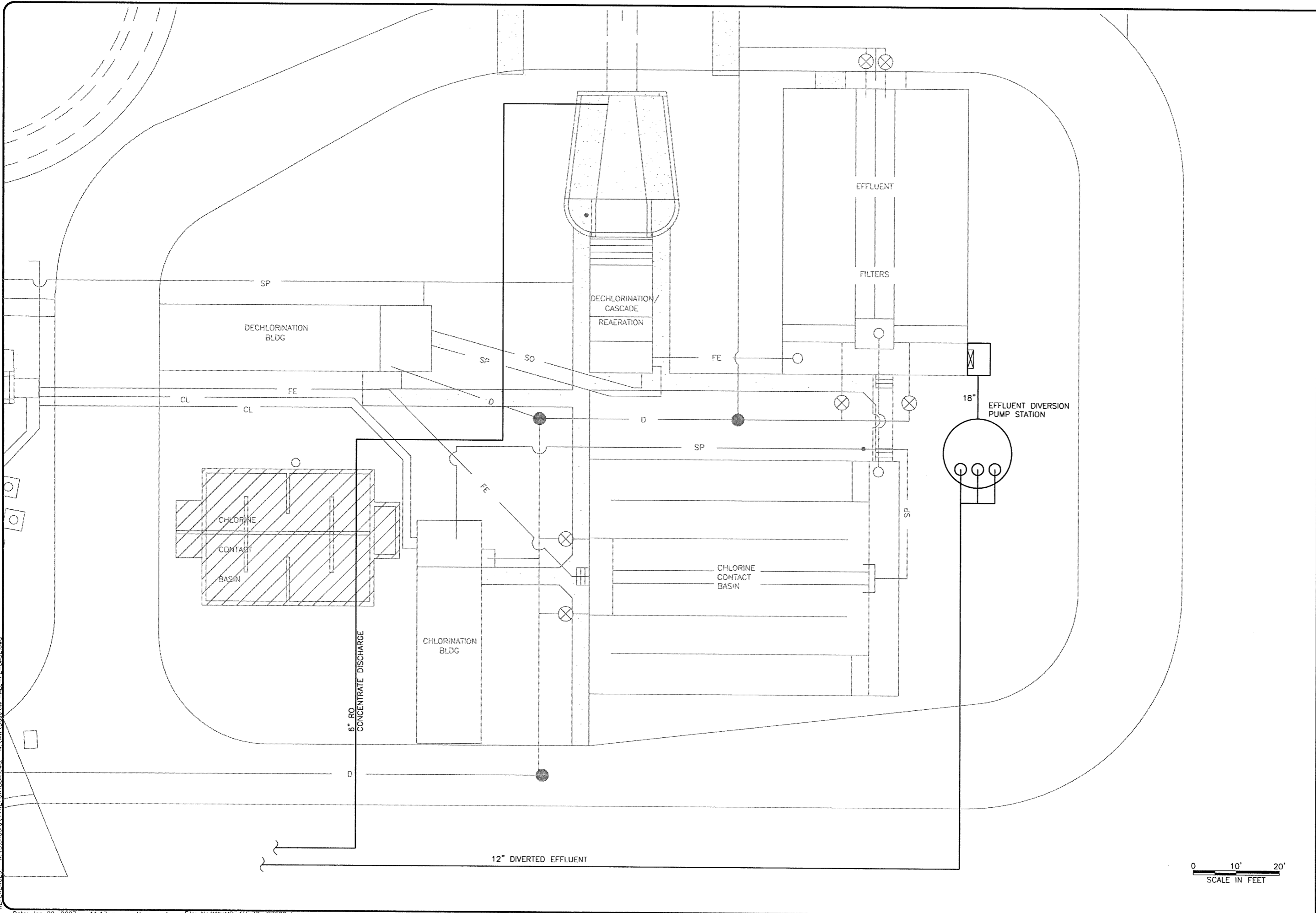

F&N JOB NO.	CMD04249
DATE	JAN 2007
SCALE	AS SHOWN
DESIGNED	DWS
DRAFTED	MAJ

COLORADO RIVER MUNICIPAL WATER DISTRICT
BIG SPRING REGIONAL WATER RECLAMATION PROJECT

EFFLUENT DIVERSION PUMP STATION -- OPTION A

Freese and Nichols
 4055 International Plaza, Suite 200
 Fort Worth, Texas 76109-4895
 Phone: (817) 735-2300
 Fax: (817) 735-2749

ACAD File: 17.Dwg (LMS Tech) User: mcj
 [CMD04249] [C:\CAD] [N:\WW\MP-ALL-PL-SITE03.dwg] LAYOUT: LAYOUT1
 Jan 22, 2007 11:17am PLS: 1 TRUST: C:\ALLFRESE.COM
 REFERENCES: N:\Storage\172REP\BDR.dwg, N:\WW\BDR\MP-ALL-PL-BASE.dwg

Date: Jan 22, 2007 11:17am User: mcj File: N:\WW\MP-ALL-PL-SITE03.dwg

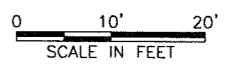
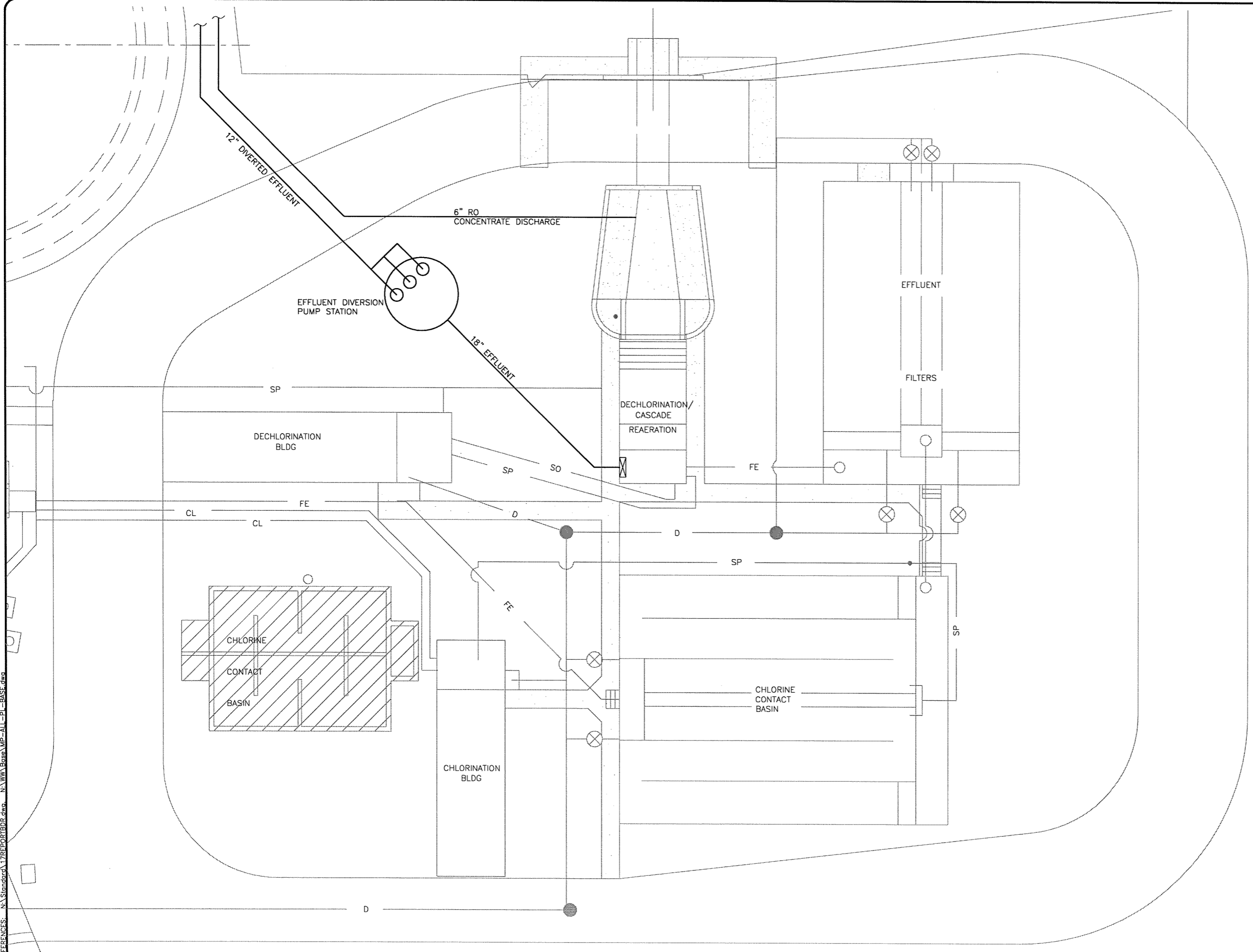

F&N JOB NO.	CMD04249
DATE	JAN 2007
SCALE	AS SHOWN
DESIGNED	DWS
DRAFTED	MAJ

COLORADO RIVER MUNICIPAL WATER DISTRICT
BIG SPRING REGIONAL WATER RECLAMATION PROJECT

EFFLUENT DIVERSION PUMP STATION - OPTION B

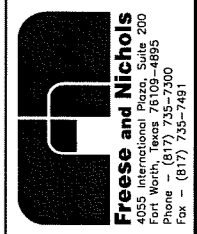

FILE: MP-ALL-PL-SITE03.dwg

ACAD Rev. 17.0s (LMS Tech) User: moj
 [CMD04249] [FWCAD1] N:\IWW\IMP-ALL-PL-SITE01.dwg LAYOUT: Layout1
 Jan 22, 2007 - 11:17am PLS: 1 TWIS: CUALI\FRESE.COM
 REFERENCES: N:\Standard\17REPORT\BDR.dwg, N:\IWW\Bases\MP-ALL-PL-BASE.dwg

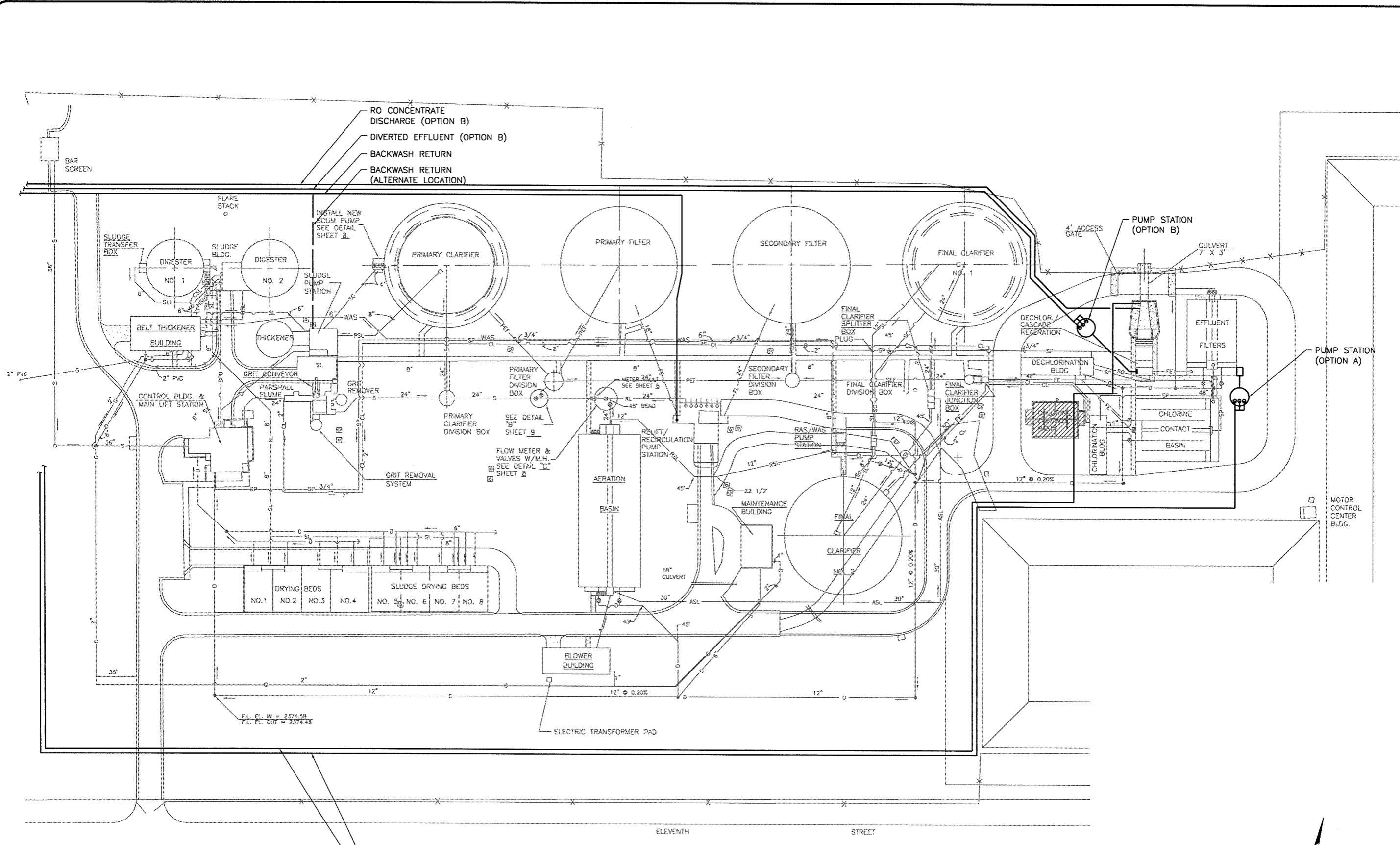

RO CONCENTRATE DISCHARGE (OPTION A)
 DIVERTED EFFLUENT (OPTION A)

RO CONCENTRATE DISCHARGE (OPTION B)
 DIVERTED EFFLUENT (OPTION B)
 BACKWASH RETURN
 BACKWASH RETURN (ALTERNATE LOCATION)

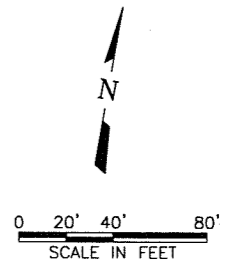

F&N JOB NO.	CMD04249
DATE	JAN 2007
SCALE	AS SHOWN
DESIGNED	DWS
DRAWN	MAJ

COLORADO RIVER MUNICIPAL WATER DISTRICT
BIG SPRING REGIONAL WATER RECLAMATION PROJECT
BIG SPRING WWTP
EFFLUENT DIVERSION AND PIPING OPTIONS

Freese and Nichols
 4055 International Plaza, Suite 200
 Fort Worth, Texas 76109-4895
 Phone - (817) 735-7300
 Fax - (817) 735-7491



MEMORANDUM

TO: Chris Wingert, P.E.

FROM: David W. Sloan, P.E., BCEE

SUBJECT: Big Spring WWTP
Connections to CRMWD Reclaim Facility

DATE: January 21, 2007

This memorandum outlines the facilities proposed to allow the interception and use of treated effluent from the Big Spring Wastewater Treatment Facility. We are attempting to identify all known issues which will require facilities or modifications within the City's plant site or otherwise affect their operations, so that the District can initiate a dialogue with the City on these issues.

Effluent Flow Interception

Effluent should be diverted at a point which takes maximum advantage of the treatment capabilities of the City's existing facility. This dictates intercepting the effluent after filtration and chlorination, but prior to discharge. Figure 1 illustrates the current facilities in the area of the filters and outfall structure. A submersible pump station is proposed east of the chlorine contact basin, with a piping connection to the filter effluent channel. Filtered, chlorinated water would flow from the effluent channel to the new wetwell by gravity, with a normal water level maintained below the elevation of the overflow weir in the outfall structure. Alternatively, the pump station could be located west of the outfall structure, with a connection into the west wall of the structure, as shown in Figure 2.

Three pumps with variable frequency drives are proposed to closely match the flow of available effluent. Excess flows beyond the pump station capacity or not meeting desired quality criteria would continue through the existing outfall for discharge to Beals Creek. Diverted flow from the new pump station would be piped to the influent storage tank located on the District's proposed Water Reclamation Facility site. If the site west of the WWTP is acquired, piping could be routed along either the north or south side of the plant, depending somewhat on which pump station location is selected. Figure 3 illustrates the entire WWTP site, with the alternative pipe routing options indicated.

Coordination issues:

1. **Power Supply.** We recommend providing power to the diversion pump station through

[CMD04249]T:\Big Spring PDR\Big Spring Tie-in Memo.doc

the existing electrical network at the City's facility. This avoids having separate supplies in overlapping areas and potential safety concerns which might result. Submetering this power usage can be provided to assign this cost as agreed between the City and District. Additional investigation is required to determine the extent of improvements necessary to power the new station.

2. **Dechlorination.** The flow requiring dechlorination and discharge will be drastically reduced and intermittent. This will result in a significant chemical savings to the City, but may complicate operations somewhat. The dechlorination facilities will need to be initiated and paced whenever flow is allowed to discharge through the outfall.
3. **Flow Monitoring.** The existing flow meter at the outfall weir will indicate the discharge flow, and will be appropriate for pacing dechlorination dosing, but will no longer be appropriate for any other pacing functions. If chlorine feed, blower output or other functions rely on total plant flow from the outfall meter, a new value will have to be calculated and substituted. A new flow measurement will be required for the effluent diversion pump station. By sharing this signal between the District and City, a new "Total Plant Flow" value can be calculated as the sum of the "diverted flow" and "discharged flow". This value would be suitable for controls and calculations based on the plant flow.

Membrane Filtration Backwash

The first additional treatment step proposed is membrane filtration, using microfiltration or ultrafiltration membranes to remove particles remaining in the treated effluent. The particles removed will accumulate on the membrane surface until they are purged by backwashing. This backwash stream, representing 5-10% of the incoming flow, will require additional handling. Most likely, an additional separation process using either a secondary membrane stage or chemical coagulation and settling will be included to capture additional water from this stream. The remainder, containing the captured solids, will require disposal. We recommend returning this stream to the City's WWTP for subsequent handling. This stream will be examined during the pilot testing phase to determine the magnitude and likely fate of the captured solids within the wastewater treatment processes. If the solids are readily biodegraded, they should be returned to the liquid stream, either through the plant headworks or directly to the intermediate pump station. If the solids are not amenable to further reduction by the activated sludge process, they should be directed to the digester (through the sludge pump station) for removal and processing with other solids from the wastewater treatment processes. Equalization of the backwash water is planned to reduce the impact to the WWTP.

Reverse Osmosis Concentrate

The second reclaim treatment step will be reverse osmosis, using additional membranes for molecular separation, removing minerals and dissolved organics. A significant stream, estimated to be about 20% of the incoming flow, will be generated which contains the segregated salts and other constituents. Although technology exists to further concentrate this stream, it is not

anticipated to be cost effective for the Big Spring project. This stream will not benefit from any of the treatment processes in place at the WWTP, but rather would contaminate the effluent, making it more difficult to treat and reclaim. Due to the recognized water quality limitations of Beals Creek, we anticipate that a direct discharge permit can be obtained for the RO concentrate.

Due to the proximity of the two facilities, it may be desirable to discharge the RO concentrate through the existing WWTP outfall structure, avoiding additional construction in the floodway. However, the discharge would be separately permitted and monitored by CRMWD.

SCADA Interface

The City of Big Spring WWTP and the proposed CRMWD Water Reclamation Facility will operate as separate facilities, each with its own staff, property, utilities and control system. However, by the nature of the reclamation plan, the two facilities are inextricably linked, and must operate with close cooperation. Key information must be shared between the facilities to allow timely response to changing conditions. Information sharing will include human interaction as well as data from the respective SCADA systems.

In general, signals should be collected according to their location to simplify wiring and panel layout. Therefore signals associated with the effluent pump station should be routed through the WWTP SCADA system, while data generated at the reclaim treatment facility would be routed through the CRMWD system. A preliminary list of shared data is shown below, and will no doubt evolve as the project progresses. Some signals are existing, while others will be added with the new facilities.

Shared Data

From Big Spring WWTP

Discharge Flow
Discharge Weir Water Level
Receiving Stream Water Level
Pump Status (On, Off, Speed)
Conductivity

From CRMWD Water Reclamation Facility

Diverted Flow
Effluent Turbidity
Effluent TOC
Effluent Chlorine Residual
Backwash Return Flow
Concentrate Discharge Flow

TCEQ Meeting March 9, 2007

CRMWD Big Spring Water Reclamation Project
TCEQ Discussion Issues

1. Review proposed treatment & blending configuration
2. Permitting or authorization required
 - 2.1. Chapter 210 reuse authorization
 - 2.2. Drinking Water Section
 - 2.2.1. Plans & specs
 - 2.2.2. Other
3. Pilot testing protocol/approval
4. Governing criteria for facilities
5. Operations and reporting requirements
6. Residuals handling
 - 6.1. Membrane backwash return to WWTP
 - 6.1.1. Direct to secondary treatment
 - 6.1.2. Direct to solids handling facilities
 - 6.2. Desalination reject to Beals Creek
 - 6.2.1. Co-disposal with WWTP outfall
 - 6.2.2. Separate outfall
 - 6.2.3. Separate permitted discharge at WWTP outfall
 - 6.2.4. Pump to Red Draw Reservoir



MEETING MINUTES

Project: CRMWD Water Reclamation Project **Meeting Minutes No.** 2

Subject: TCEQ Interpretations of project issues

Recorded By: David Sloan

Date: March 9, 2007

Location: TCEQ Offices, Austin

Attendees: John Grant, Chris Wingert – CRMWD
Mike Cowan, Doug Holcomb – TCEQ/Water Supply Division
Mike Lannen – TCEQ/Public Drinking Water
Todd Chenoweth – TCEQ/Water Rights
Firoj Vahora – TCEQ/Municipal Permits
Kelly Holligan – TCEQ/Industrial Permits
Louis Herrin – TCEQ/WW Permitting Technical Support
Steve Watters, David Sloan – Freese and Nichols, Inc.

The following reflects our understanding of the items discussed during the subject meeting. If you do not notify us within five working days, we will assume that you are in agreement with our understanding.

- | Item | Description |
|-------------|--|
| 1.1 | General. Following introductions, John Grant gave a brief background and overview of the project. He noted the favorable feasibility determination and the District's intention to proceed with implementation of the Big Spring project. He also noted the District had negotiated an agreement with their member cities providing them title to the municipal effluent which is currently unused. |
| 1.2 | David Sloan distributed a project schematic (attached) and the explanation of issues (attached) requiring input from TCEQ staff (which had also been provided by email to most of the participants.) He noted a similar meeting had been held in the fall of 2004 to provide information during the feasibility study, and this meeting was to revisit some of the issues to confirm that regulatory conditions had not changed and to discuss additional questions arising from more detailed consideration of the project. |
| 2.1 | Permitting/Approvals. David Sloan reviewed previous TCEQ indications that approval for blending repurified effluent with raw surface water would consist of a reuse authorization and review of plans and specifications. Mike Cowan confirmed this was still the case, and that plan submittal should go through him. John Grant asked who |



- should be the overall point of contact for TCEQ on this project, and Mike said this should go through him. Louis Herrin clarified that the reuse authorization (Chapter 210) would only apply to the transfer of effluent from the City of Big Spring to the CRMWD treatment facility. He noted this should be in the name of Big Spring as the reclaimed water provider.
- 3.1 **Pilot Testing.** David Sloan noted that the planned pilot testing would probably largely follow a protocol similar to that used for membrane filtration of surface water, but would include the reverse osmosis step as well, with testing conducted by “teams” of paired filtration and RO test rigs. Mike Cowan said the protocol submittal should be directed to him and he would review it or distribute it as appropriate.
- 4.1 **Governing Criteria.** David asked for guidance on application of criteria to the water produced by the project. There was general consensus that the water was “reclaimed water” from the Big Spring plant to the CRMWD treatment facility, and the product water was “surface water”, not requiring special handling. Mike Lannen asked whether there would be 500 ft. separation between the product water storage and the wastewater treatment plant. It was unclear whether this criterion would apply since it is normally applied to drinking water tanks. Mike was to investigate this further and let FNI/CRMWD know.
- 4.2 Todd Chenoweth will check the water rights permit for Spence Reservoir to confirm that there is no need to modify anything in the permit to allow direct reuse from Spence-derived effluent.
- 5.1 **Operations and reporting requirements.** David asked if there were any special requirements for operator certification, monitoring or reporting for the reclaimed water treatment facilities. Mr. Lannen indicated the Drinking Water Section would expect to get monitoring reports of the plant operation, but there were no requirements established. John Grant noted the District’s desire to keep operator credentials as flexible as possible since the plant would not be producing potable water.
- 6. Residuals handling.**
- 6.1 **Membrane backwash.** David explained the membrane backwash would likely be returned to the head of the Big Spring WWTP. Although other points could make technical sense as a return point, the consensus was that anything other than the headworks would draw objection from U.S. EPA as a treatment bypass. Firoj Vahora noted this flow should be evaluated against the plant capacity to confirm it will not be detrimental to the plant’s operation.
- 6.2 **Reverse Osmosis Concentrate.** David outlined plans to obtain a new permit to discharge the RO concentrate directly to Beals Creek. Kelly Holligan confirmed this would be an industrial discharge permit, governed primarily by compliance with the allowable stream standards, particularly for TDS, chloride and sulfate. Since Beals Creek is not a designated stream segment, it will be evaluated for the reach where it enters the Colorado River, which is the segment including Lake Spence, with a TDS standard of 20,000 mg/l. The RO concentrate, at a projected concentration of 10,000-11,000 mg/l TDS, will likely be acceptable given the minimal ambient conditions. TCEQ will have to verify that this will not be detrimental to downstream aquatic life, but they also recognize the short distance prior to the Beals Creek Pump Station, where the



- water is diverted for secondary uses and evaporation.
- 6.2.1 Kelly also noted due to the municipal wastewater source, there would need to be a determination whether to regulate BOD or other oxygen demand parameter for this discharge.
 - 6.2.2 David noted some consideration had been given to discharging the concentrate at the existing WWTP discharge point, but this had been avoided due to the location of the plant's monitoring point. Kelly noted there was actually a requirement for a 300 ft. separation between separately permitted outfalls.
 - 6.2.3 David asked if a permit would be required for direct discharge to Red Draw Reservoir, where the Beals Creek Pump Station discharges. Kelly explained that while the diversion at Beals Creek does not require a discharge permit, pumping surface water into an off-channel reservoir, the RO concentrate, as a waste discharge would require a permit, similar to that issued to the Alon Refinery.
 - 6.2.4 David asked how long a typical new permit should take. Kelly answered a new permit should normally take <330 days, but was affected by workload. Louis noted a large number of industrial permit renewals would soon be in the system due to the basinwide permitting schedule for the Houston Ship Channel. Kelly noted the application could be prepared with estimated numbers currently available, and could be amended with pilot test results when available.
- 7. Big Spring WWTP Permit Impacts**
- 7.1 Louis explained that the reuse authorization would require monitoring for the flow diverted for reclamation ("Outfall 800 or 900" depending on whether the reuse is type 1 or type 2), while the discharge permit would continue to monitor flow and quality of the water discharged. Periodic quality monitoring on the reclaimed water will also be required to verify compliance with the appropriate limits for reuse. A combined total will also be monitored to verify that the total flow through the plant remains within the permitted capacity of the plant.
 - 7.2 Biomonitoring will continue to apply to the discharged effluent. If the City can demonstrate changed conditions, there may be grounds for modification of the biomonitoring dilution factor.
 - 7.3 David explained the potential for occasional quality excursions to render the City's effluent undesirable for reclamation, and the potential for this to reflect badly on the WWTP discharge, although the plant was normally producing high quality effluent. Kelly clarified that at least 4 samples were required for an average type value, even if it required inclusion of data from previous months. However, there is still a potential issue of poor compliance data if a discharge only occurs when quality is sub-par. Firoj suggested that it may be beneficial to maintain a small discharge to allow normal monitoring and inclusion of the good data along with any potentially "bad" data.

CRMWD Big Spring Water Reclamation Project
TCEQ Discussion Issues

1. **Project Description.** CRMWD conducted a feasibility study to evaluate three potential projects to reclaim treated municipal effluent for blending into surface water supplies for municipal use. Although all three projects appear feasible, the project in Big Spring is the most attractive, and most easily implemented. The proposed project will divert filtered secondary effluent from the Big Spring WWTP to a tertiary reclamation plant to be owned and operated by the District. Proposed treatment will consist of membrane filtration, reverse osmosis and UV disinfection and/or advanced oxidation. Some of the reclaimed water may be sold to industrial customers, but the remainder will be pumped into an existing raw water transmission where it will blend with water from Lake Spence. This raw water is one of several sources which are distributed to the District's member and customer cities for subsequent surface water treatment and municipal distribution. The attached figure illustrates the proposed configuration.
2. **Permitting/Approvals.** From our previous meeting in October 2004, state approval would be limited to a reuse authorization and review of plans and specifications. Has anything changed in this regard? Will the reuse authorization be through the current Chapter 210 process? Will plan review be by the Drinking Water group or by the Wastewater Treatment group?
3. **Pilot testing protocol/approval.** The District plans to conduct pilot testing for the membrane filtration and reverse osmosis. Will any prior approval (protocol) or submission of results be required by TCEQ? Will TCEQ need results from each of the pilot plants, or will results from the selected pilot process be sufficient?
4. **Governing criteria.** Design criteria for various treatment, storage and conveyance facilities are contained in Chapter 210 (Reclaimed Water), Chapter 290 (Drinking Water), and Chapter 317 (Wastewater). Is there any guidance available for which rules should govern a particular process or flow stream? (i.e. When does effluent become simply "water", for purposes of separation distances or other requirements?) Although the facility's final product is expected to meet drinking water quality criteria, no one is proposing to consider it as drinking water before it is blended and re-treated. At the same time, it should be free of the taint of wastewater when it leaves the facility.
5. **Operations and reporting requirements.** What reporting requirements are anticipated for the proposed facility? What water quality testing is expected? What operator certification, if any, should be expected? Would the reporting and certification requirements be different if the plant only discharges to an industrial customer?
6. **Residuals handling.** Two residual streams will be generated by the proposed facility. Each will require planning for their disposition.
 - 6.1. **Membrane backwash.** The flow and character of the backwash stream will be better defined following pilot testing. Some flow may be internally recycled back to the membrane filtration influent. Some or all of the flow may be returned to the wastewater

Proposed Big Spring Reclamation Project

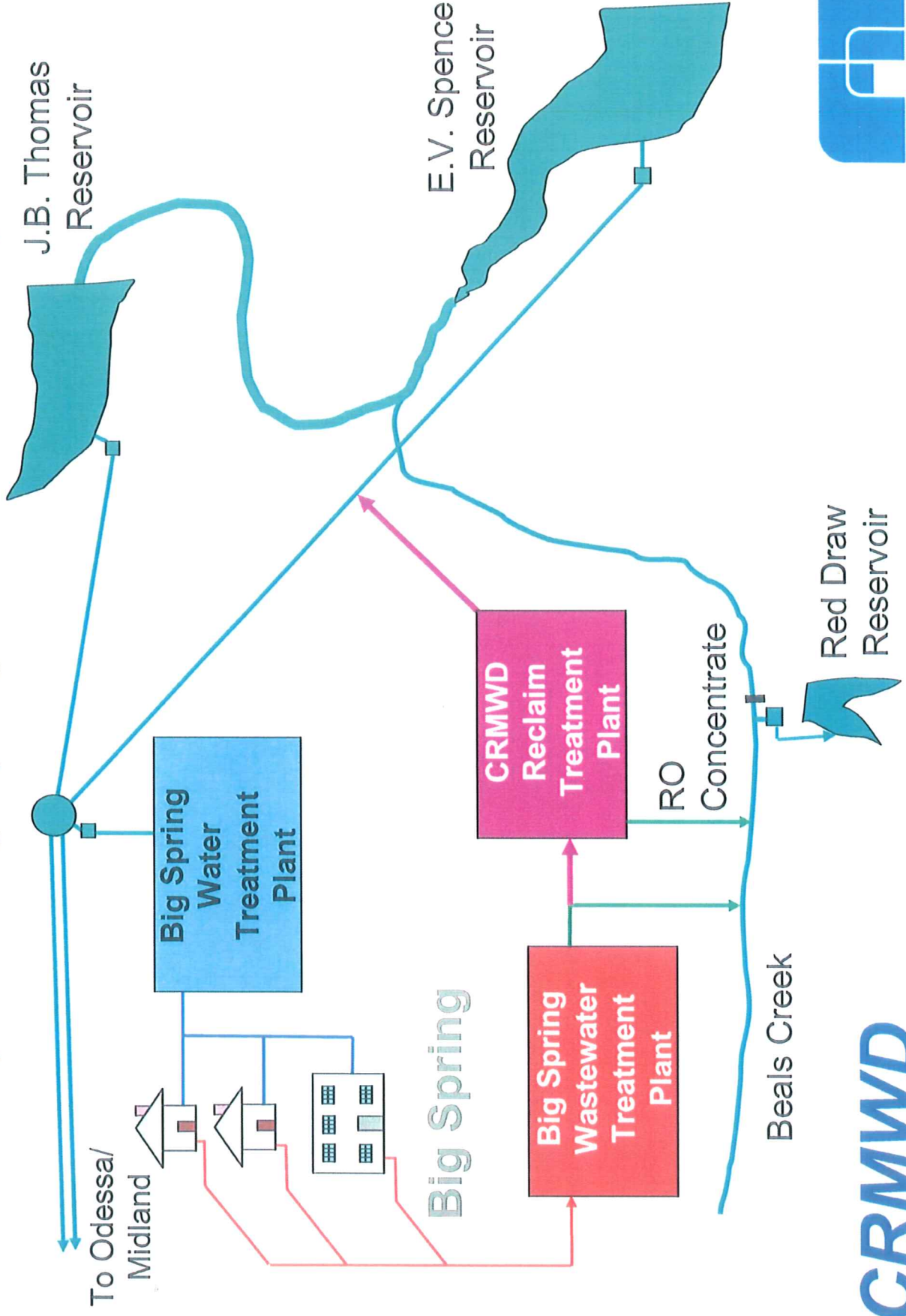

Appendix D: Public Education and Information Material

Kick-off Meeting to Stakeholders August 17, 2004

**Project Kickoff Meeting
Regional Water Reclamation Project
Colorado River Municipal Water District**

**Date: Tuesday, August 17, 2004
Time: 10:00 a.m. – 12:00 noon
Location: Dora Roberts Community Center
Big Spring, Texas**

AGENDA

- | | | |
|---|------------------------------------|--------------------|
| 1. Welcome and Introductions | John Grant, CRMWD | 10:00 – 10:10 a.m. |
| 2. Background and Purpose of Study | John Grant, CRMWD | 10:10 – 10:20 a.m. |
| 3. Proposed Projects | John Grant, CRMWD | 10:20 – 10:30 a.m. |
| a. Big Spring | | |
| b. Snyder | | |
| c. Odessa-Midland | | |
| 4. Potential funding assistance | Mike Morrison, Freese and Nichols | 10:30 – 10:40 a.m. |
| 5. Technology Overview | | |
| a. Reclaimed water use | David Sloan, Freese and Nichols | 10:40 – 10:50 a.m. |
| b. Membrane water treatment | Mike Morrison, Freese and Nichols | 10:50 – 11:10 a.m. |
| c. Aquifer storage & recovery | Neil Blandford, Daniel B. Stephens | 11:10 – 11:20 a.m. |
| 6. Issues to be addressed in feasibility study and preliminary design | David Sloan, Freese and Nichols | 11:20– 11:40 a.m. |
| a. Required treatment and quality for supplemental water supply | | |
| b. Public information and acceptance | | |
| c. Membrane reject management | | |
| d. Probable costs of reclaimed water vs. other options | | |
| 7. Data collection request | David Sloan, Freese and Nichols | 11:40 – 11:45 a.m. |
| 8. Questions, concerns & suggestions | John Grant, CRMWD | 11:45 – 12:00 noon |
| 9. Adjourn & Lunch | | 12:00 noon |
-



Project Kickoff Meeting



CRMWD Regional Water Reclamation Project

August 17, 2004





CRMWD Mission Statement

"The mission of the Colorado River Municipal Water District is to maintain an adequate supply of the best quality water possible, at a reasonable cost, for its service area in West Texas."



Sources of Supply

- Surface Water
- Groundwater
- Conservation
- Reuse
- Demineralization of brackish water



Water Supply Management

- Conservation
- Salt Cedar Control
- Concho Water Snake
- Watershed Management





Why Water Reclamation?

- Readily available source
- Technology is improving and more affordable
- Already pumped to the cities
- Drought-proof supply
- As cities grow, supply increases
- Better quality than raw lake water
- CRMWD system for blending with ASR
- Use 100% of the water 100% of the time

CRMWD
Central River Municipal Water District



Feasibility Study

- 6 months (January 2005)
- TWDB Funding
- TCEQ Requirements
- Concept Facilities
- Concept Costs
- Public Education

CRMWD
Central River Municipal Water District



Go or No Go

- December '04 through February '05
- CRMWD Board will evaluate the feasibility study
- Contract amendments with member cities
- Agreement with Midland
- Agreements with Gulf Coast WDA and/or Alon USA

CRMWD
Central River Municipal Water District



Preliminary Design Report

- 9 months (October 2005)
- 3 separate projects – required facilities
- Aquifer storage and recovery (ASR)
- Brine disposal
- Regulatory issues
- Estimated construction cost
- Estimated O&M cost
- Concept cost for other sources
- Funding options
- Public education

CRMWD
Central River Municipal Water District



Starting in November 2005

- Begin securing funding
- Land and right-of way acquisition
- Permit acquisition
- Geotechnical field work (detailed design and ASR)
- Pilot testing for membranes
- Begin detailed design

CRMWD
Central River Municipal Water District

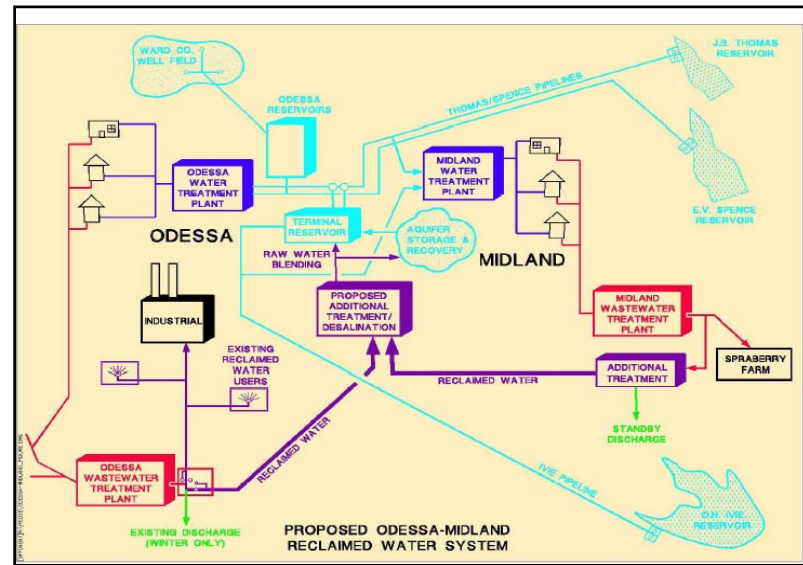
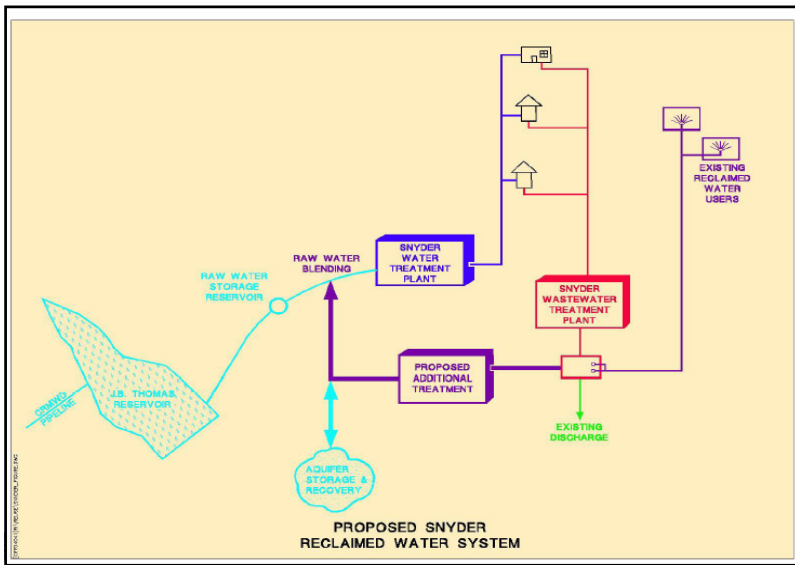
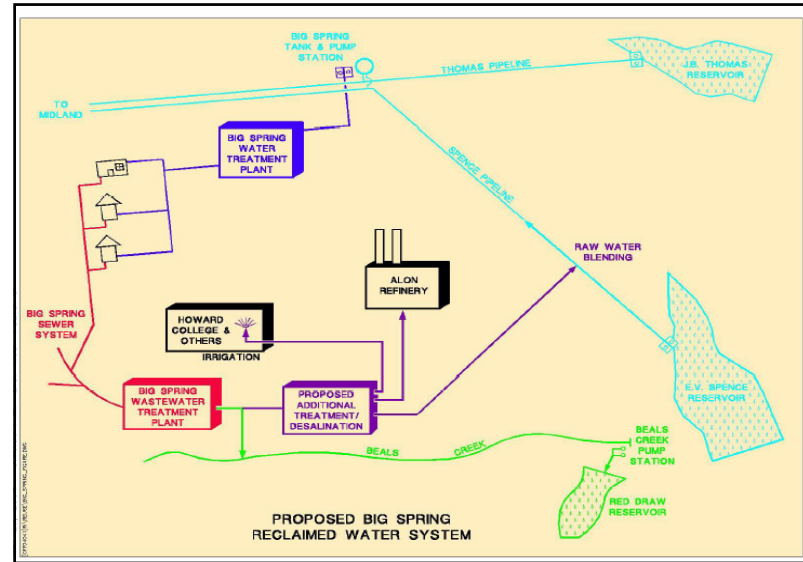



Potential Funding Assistance

Mike Morrison, P.E., DEE
Freese and Nichols, Inc.

CRMWD
Central River Municipal Water District

Potential Funding Assistance

- Politicians and Agencies are eager to support reuse and desalination
- Governor Perry has made desalination a key initiative of his term
- Pending federal legislation proposes to subsidize desalination operating costs
- Project is a good candidate for regional planning grant

CRMWD
Central River Municipal Water District



Potential Funding Assistance - Feasibility Phase

- Texas Water Development Board
 - Regional Facility Planning Grant
 - Water Research Grant
- U.S. Bureau of Reclamation
- Environmental Protection Agency
- Water Environment Research Foundation
- American Water Works Association Research Foundation

CRMWD
Central River Municipal Water District



Potential Funding Assistance - Design/Construction Phase

- Texas Water Development Board
 - Clean Water State Revolving Fund
 - Drinking Water State Revolving Fund
 - Other low interest loan programs
- U.S. Bureau of Reclamation
- U.S. Department of Commerce
 - Economic Development Administration, Public Works Program

CRMWD
Central River Municipal Water District



Potential Funding Assistance – Operational

- Desalination Energy Assistance Act of 2004 (H.R. 3834)
 - Proposes to subsidize energy cost for desalination of brackish water supplies for up to five years
 - Appears to be gaining momentum in Congress

CRMWD
Central Region Metropolitan Water District



Reclaimed Water Use

David Sloan, P.E., DEE
Freese and Nichols, Inc.

CRMWD
Central Region Metropolitan Water District



“Conventional” Re-use

- Landscape Irrigation – Golf Courses, etc.
- Power Plant Cooling Water
- Construction Dust Control
- Industrial Process Water
- Disposal Farms
- Wastewater Treatment Plant Service Water
- Established Rules in Place – Chapter 210
- Usually requires little additional treatment

CRMWD
Central Region Metropolitan Water District



Definition of Terms

- Indirect Potable Reuse – Introduction of wastewater-derived source into potable supply
- Indirect Reuse – Introduction of treated wastewater effluent into water body used as a water source
- Direct Reuse – Use of treated wastewater effluent without discharge

CRMWD
Central Region Metropolitan Water District

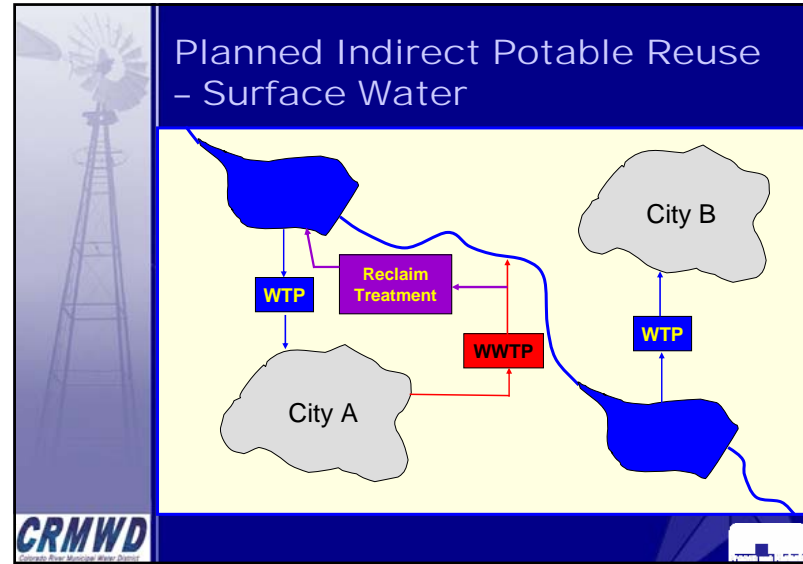
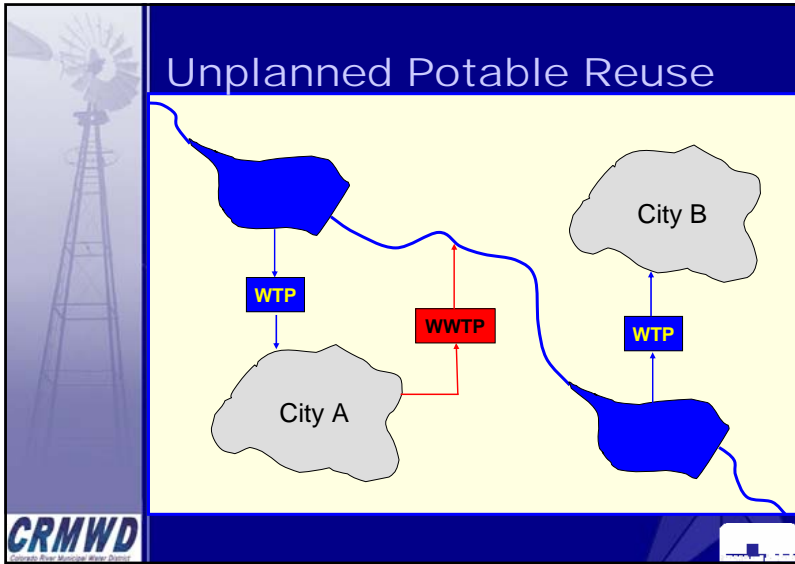

Indirect Potable Reuse - Surface Water

Operating Projects include:

- > Upper Occoquan Sewage Authority, Manassas, Virginia

Developing Projects include:

- > City of Wichita Falls
- > Tarrant Regional Water District

Past Studies include:

- > City of Abilene
- > Cities of McAllen & Edinburg

CRMWD

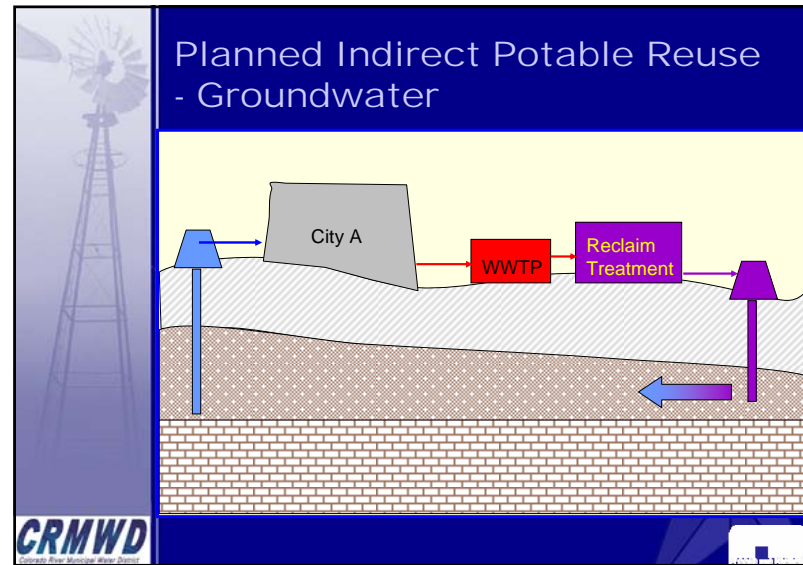

Indirect Potable Reuse - Groundwater

Operating Examples:

- El Paso Fred Hervey Reclamation Plant/Hueco Bolson Recharge Project
- Orange County California Seawater Intrusion Barrier

CRMWD Regional Water Reclamation Concept

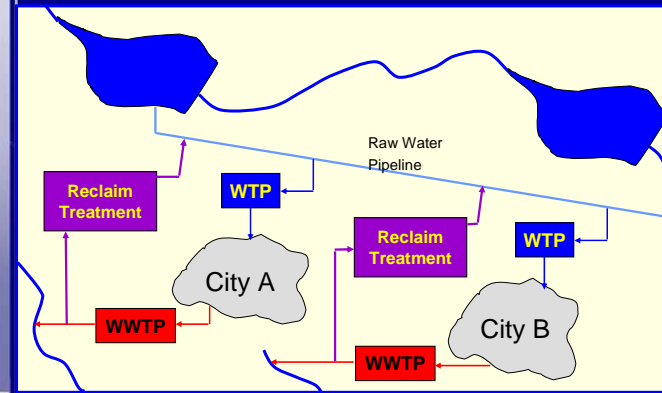

Integrated Water Resources Management Strategy

"Current engineering practice can provide treatment systems that are capable of reliably eliminating pathogens and reducing organic and inorganic contaminant concentrations to very low levels in reclaimed water. Therefore, local authorities should consider indirect potable reuse of reclaimed water as part of an integrated water resources management strategy."

WEF web article approved October 2, 1998

Reclaimed Water for Public Water Supply Purposes – Policy Statement

"AWWA encourages responsible use of reclaimed water instead of potable water for irrigation, industrial, and other nonpotable uses within a public drinking water supplier's service areas when such use can reduce the demands placed on limited supplies of potable water."

"In cases where raw water sources are limited, AWWA recognizes the value of indirect use of water to supplement existing raw water sources. These waters must receive appropriate subsequent treatment and be acceptable to health authorities and water users."

AWWA eMainStream article posted March 2, 2004

Municipal Reuse in Texas

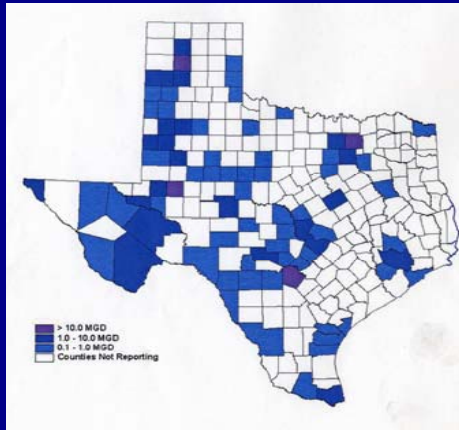

Membrane Water Treatment

Mike Morrison, P.E., DEE
Freese and Nichols, Inc.

Membrane Technologies...

Particle Removal

- Microfiltration - (MF)
- Ultrafiltration - (UF)

Molecular Removal / Desalination

- Nanofiltration - (NF)
- Reverse Osmosis - (RO)
- Electrodialysis Reversal - (EDR)

Cumulative Number of Membrane Filtration U. S. Installations

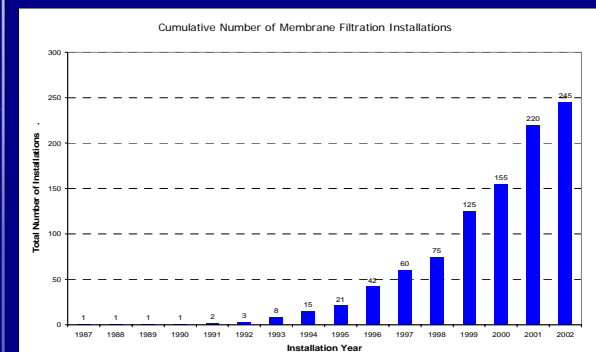

Cumulative Membrane Filtration Capacity U.S. Installations

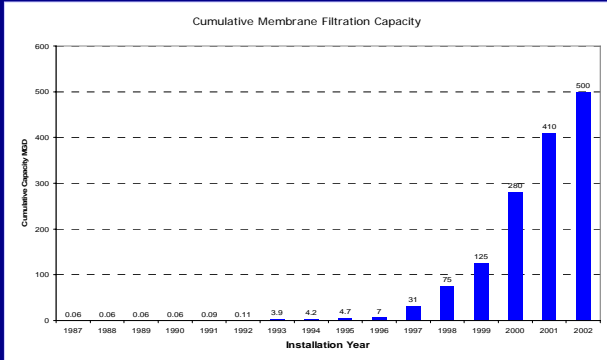

Membrane Projects in Texas

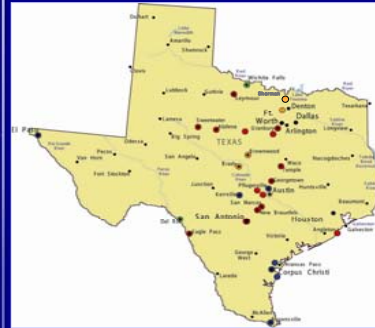

- Boxer Metropolitan (San Antonio)
- Brazos River Authority SWATS
- Brown County Water Improvements District No. 1
- Canyon Regional (New Braunfels)
- Canyon Regional (San Marcos)
- City of Abilene
- City of Brady
- City of Dal Rio
- City of Eagle Pass
- City of El Paso
- City of Granbury
- City of Kerrville
- City of Pflugerville
- City of Seymour
- City of Sherman
- City of Temple
- City of Wichita Falls
- Corpus Christi - Barney District *
- Corpus Christi - Padre Island
- Freeport Poseidon - Brazos River Authority*
- Port of Brownsville*
- San Patricio Water District (Ingleside)
- Lake Georgetown (Brushy Creek MUD)
- Travis Water District #7
- Travis Water District #8
- Upper Trinity River Authority (Harpool WTP)

Color Legend
 Operational - Red
 Construction - Green
 Design - Gold
 Piloting - Blue

* Texas Water Development Board Large Scale Demonstration Seawater Desalination Projects



Source Water Quality Parameters Impacting Cost

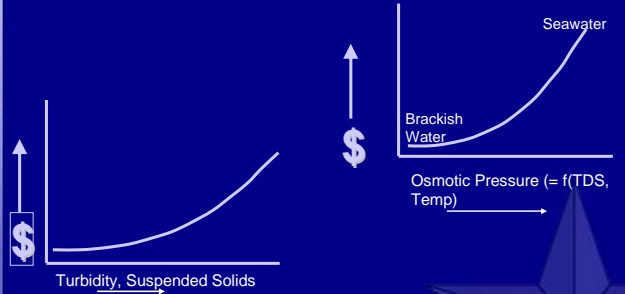

Seawater Desalting is Dramatically More Complex than Desalting Brackish Water or Wastewater



Cost Trends Conventional vs. Membranes

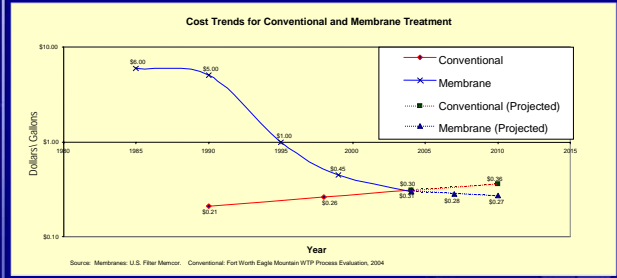

Source: Membranes: U.S. Filter Membr. Conventional: Fort Worth Eagle Mountain WTP Process Evaluation, 2004



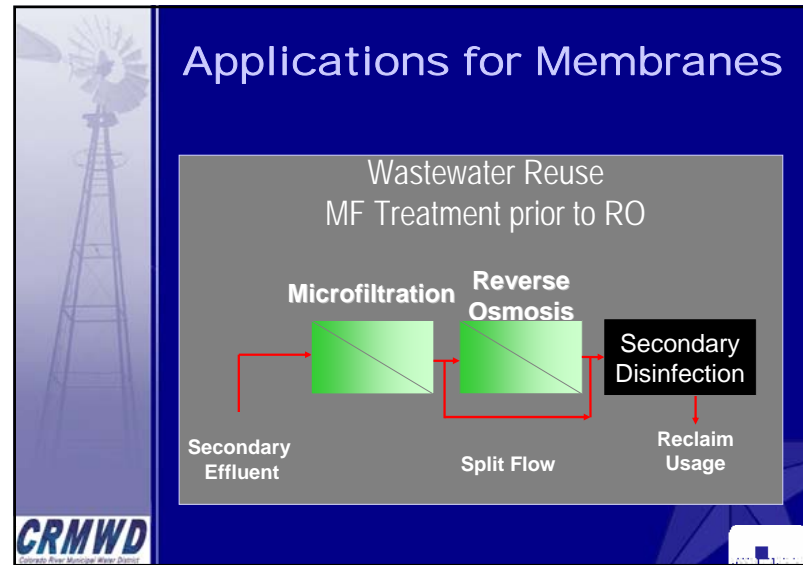
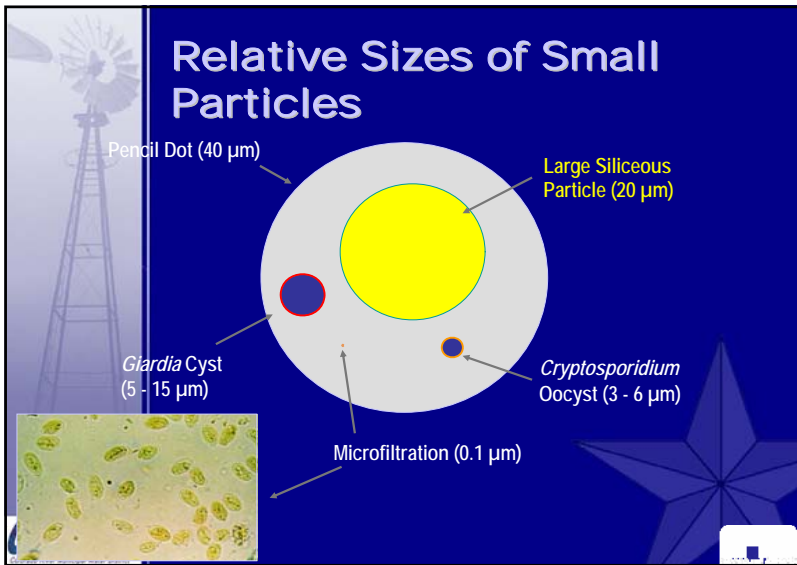
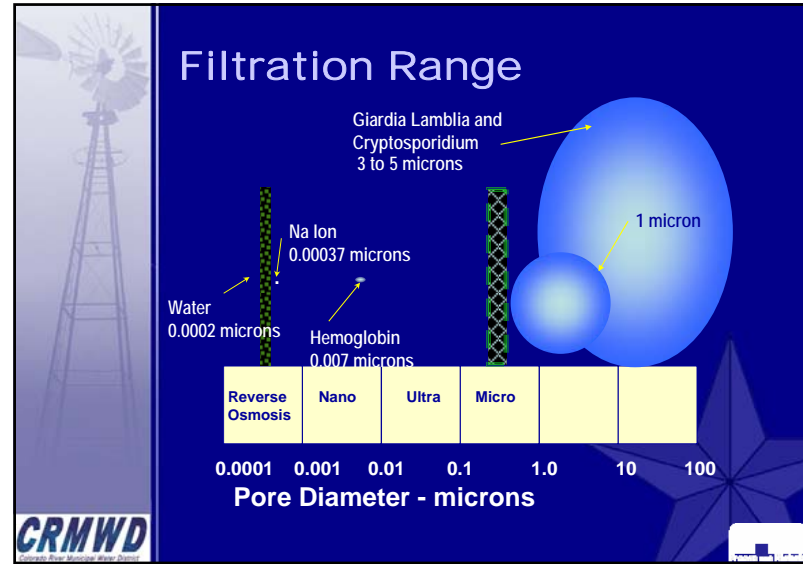
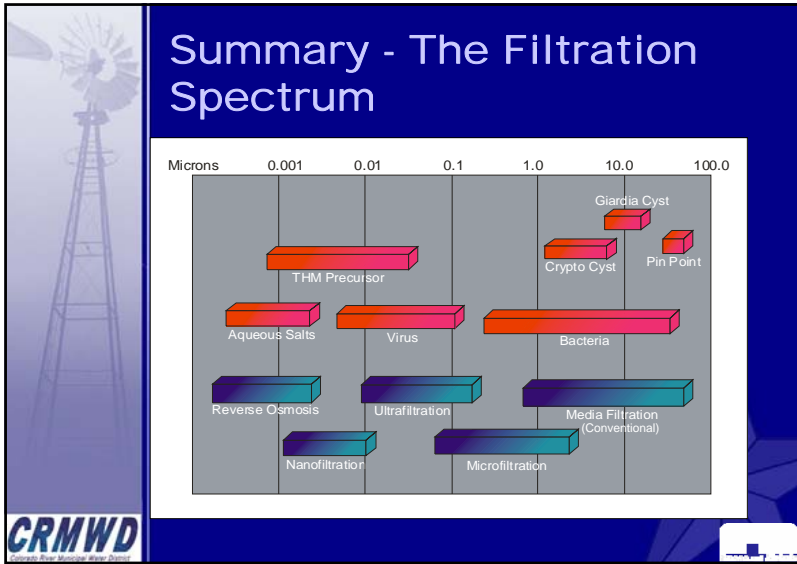

Emerging Water Quality Concerns

- Emerging Pathogens
 - *Cryptosporidium*
 - *Giardia*
 - *Legionella*
 - *Mycobacterium Aves complex*
 - *Microsporidia*
 - *Enterovirus*
- Endocrine Disruptors
- Pharmaceutically Active Chemicals
- Terrorism Agents
 - Chemical [*cyanide*]
 - Biochemical [*plague*]

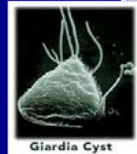
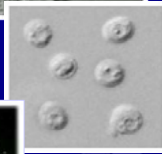

Giardia Cyst

MF and UF Modules

- Vary in module type and size
 - Immersed
 - Pressurized
- Vary in membrane materials
- Pore size and capillary diameter may differ
- Position (horizontal versus vertical arrangements)
- Operating Principles
 - Inside-out
 - Outside-in
- Different backwash flush cycles
 - Air/water
 - Enhanced Backwash Cleaning
 - Chemical In-place Cleaning



Electrodialysis

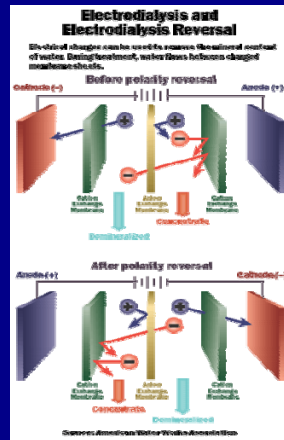

Reverse Osmosis

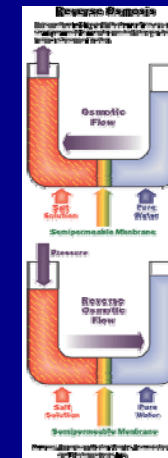

Reject from Demineralization

- All processes produce reject
- Quantity and quality depend upon
 - Feed water quality
 - Treated water quality
 - Process

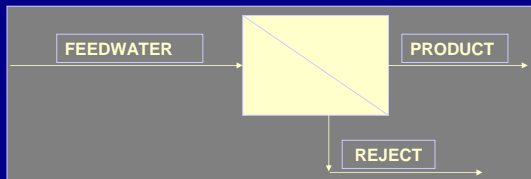

Plants Sourced by Brackish GW

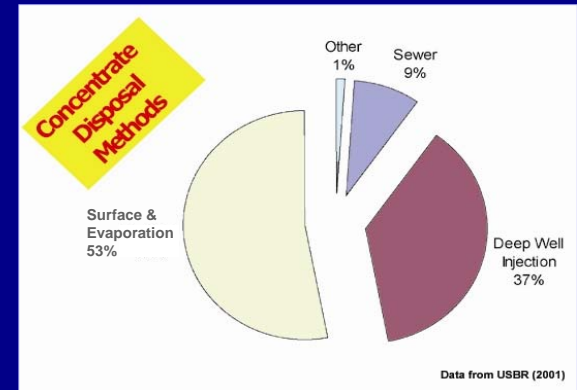

HB 2567

Proposed Rule for the Disposal of Brine Desalination Operations

"HB 2567 allows the TCEQ to issue a permit to dispose of brine produced by a desalination operation in a Class I injection well without proving the opportunity for a contested case hearing, although there will be public notice and comment requirements. The proposed rule addresses the conditions under which such permits may be granted by the Commission. Comments are due by May 10, 2004."

Environmental & Municipal Update 12

San Patricio Municipal Water District, Texas (7.8 MGD)



City of Seymour, Texas (3 MGD)



Supervisory Control System



Membrane Assemblies



CRMWD
Central River Municipal Water District

Bexar Metropolitan Water District, San Antonio, Texas Ultrafiltration Water Treatment Plant

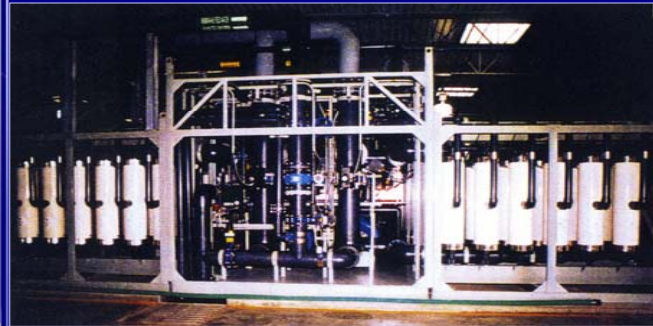

CRMWD
Central River Municipal Water District

Bexar Metropolitan Water District, San Antonio, Texas Ultrafiltration WTP Process Flow Diagram

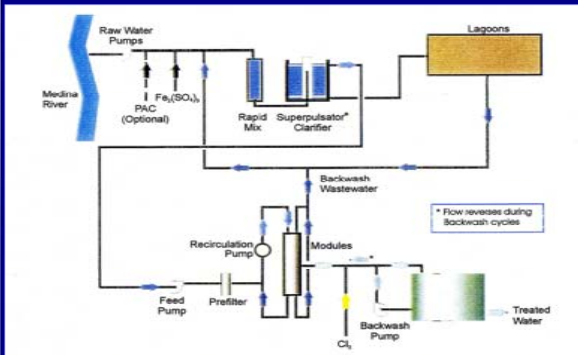

CRMWD
Central River Municipal Water District

City of Abilene, Texas (8 MGD)



CRMWD
Central River Municipal Water District

City of Sweetwater, Texas (6 MGD)



CRMWD
Central River Management District



Brown County WCID #1, Texas (Pilot Test)



CRMWD
Central River Management District



Aquifer Storage & Recovery and Groundwater Recharge

Neil Blandford
Daniel B. Stephens, Inc.

CRMWD
Central River Management District



Aquifer Storage & Recovery (ASR)



- Definition: To store and later recover water supplies in an aquifer
- Engineers use ASR to mean injection and recovery from the same well
- Term "artificial recharge" often used, i. e. ASR equals artificial recharge and recovery

CRMWD
Central River Management District





Why Use Aquifer Storage?

- Prevents loss to evaporation and protects water quality
- Municipalities and others with surface water or reclaimed water supplies can store for peak demands (e.g. summer) and drought periods
- Cones of depression from historical pumping are ideal storage locations



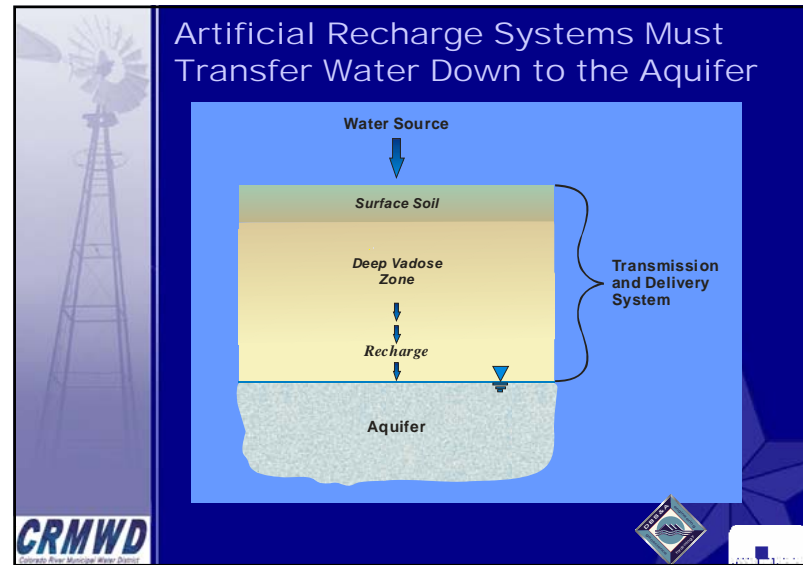
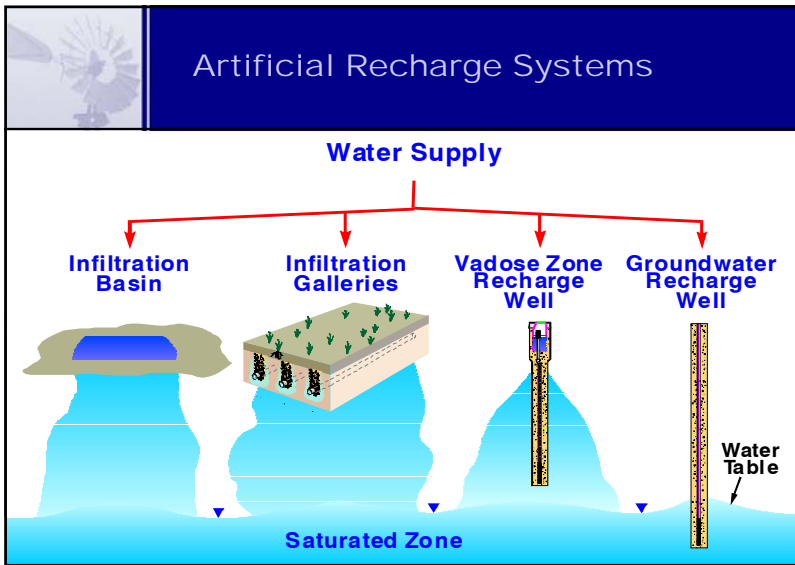

Artificial Recharge Systems Require Three Basic Elements

- A suitable water source
- A recharge delivery system across the vadose zone
- Sufficient storage capacity in the receiving aquifer

Choice for a Recharge Delivery System Depends on Site Soil Hydraulic Properties

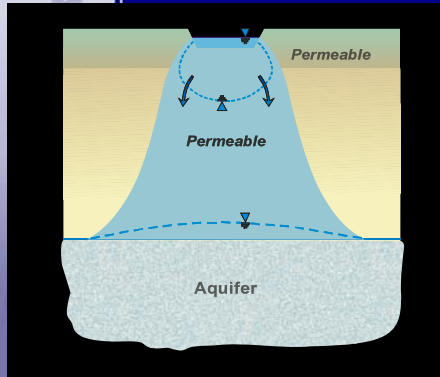

- If permeable vadose zone
- use surface ponds, basins, channels, arroyos



Choice for a Recharge Delivery System Depends on Site Soil Hydraulic Properties

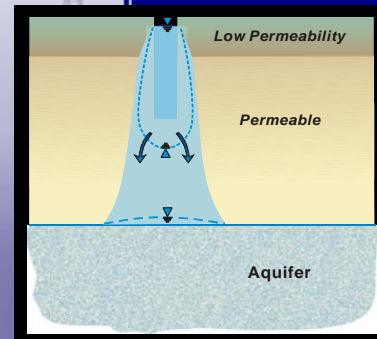

- If low-permeable surface soil and permeable vadose zone –
- use trenches, dry wells



Choice for a Recharge Delivery System Depends on Site Soil Hydraulic Properties

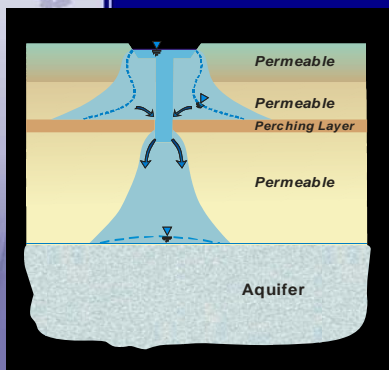

- If permeable soil but perching layer
- -use combination of surface ponds, etc., with deep trenches or dry wells



Choice for a Recharge Delivery System Depends on Site Soil Hydraulic Properties

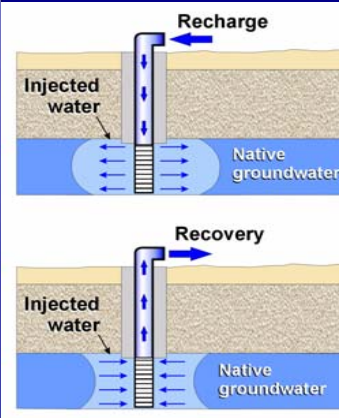





- If low-permeable surface soil and low permeable vadose zone –
- use aquifer injection wells (no vadose zone filtration)









Project Considerations for ASR

- Capacity of the aquifer to accept recharge
- Knowledge of vadose zone properties
- Recapture of recharged water
 - Aquifer properties
 - Time between recharge and extraction events
 - Optimum use of existing infrastructure
- Geochemical compatibility of recharge and native waters
- Relative costs of alternative methods





Feasibility Study Issues

David Sloan, P.E., DEE
Freese and Nichols, Inc.





Required Treatment & Quality

- Public Health Protection – Multiple Barriers to pathogens and other pollutants
- TCEQ Approval
- Desired Improvement in Raw Water Quality
- Satisfy public opinion



Public Information & Acceptance





- Public objections & political games have undone several potable reuse projects
- Provide sufficient information to allow rational consideration
- Frame issues to minimize emotional responses
- Provide opportunities for appropriate public input









Membrane Reject Management

- Deep Well Injection
- Surface Discharge
- Evaporation
- Brine Concentration & Disposal
- Balance Water Yield, Cost and disposal method limitations





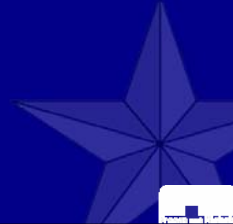

Project Probable Costs

- Capital & Operating Costs Important
 - Phase 1 – Concept Level
 - Phase 2 – Preliminary Estimates
- Compare to Reconnaissance-level costs for other identified water supplies:
 - Alan Henry Reservoir
 - Midland T-Bar Well Field
 - Hovey Trough Groundwater
 - Roberts County Groundwater



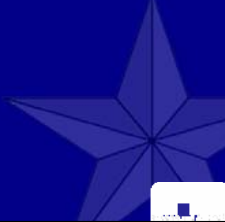

Data Collection Request

- Requests mailed out last week
- Data needed by end of August
 - Will take today or at site visit if available
 - Will accept in parts
- Questions on request?

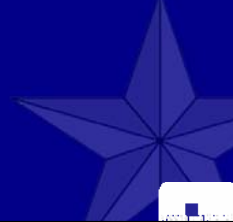

- Questions?
- Comments?
- Concerns?
- Suggestions?



Colorado River Municipal Water District
 Regional Water Information Project
 Kick-Off Meeting
 August 17, 2004

Name	Representing	Phone	E-Mail
JOHN GRANT	CRMWD	267-6341	JGRANT@CRMWD.ORG
Ron Lemons	FNI	817-735-7254	RML@freese.com
Chris Winger	CRMWD	267-6341	CWinger@cmwd.org
Mike Morrison	FNI	817-735-7250	mgon@freese.com
IGNACIO CADENA	FNI	817-735-7283	ico@freese.com
Scott Wagoner	Huntsman	432-640-8577	scott-a-wagoner@huntsman.com
William Beer	Tex Ind Eng	620-5750	blouse@tielp.com
Joe Cumbest	CRMWD	580-2806	JCumbest@CRMWD.com
Polly Lancaster	CRMWD	267-6341	plancaster@CRMWD.org
Carla Harrold	CRMWD	"	charrold@CRMWD.org
Ralph Truskowski PE	CRMWD	"	ret@CRMWD.org
Wendell Barber	CRMWD	267-6341	wcb@CRMWD.org
David Sloan	FNI	817-735-7277	dws@freese.com
Matt Ruid	City of Odessa	(432) 335-4636	mruid@ci.odessa.tx.us
Debbie McReynolds	City of Odessa	(432) 335-4634	dmcreyn@ci.odessa.tx.us
David Willard	City of Odessa	(432) 335-4117	dwillard@ci.odessa.tx.us
MARCUS JOHNSTON	City of MIDLAND	432-685-7203	mjohnston@ci.midland.tx.us
KAY SNYDER	"	" 7261	Ksnyder@mail.ci.midland.tx.us
STUART PURVIS	"	" 7262	SPURVIS@
TIM LEAVER	CRMWD		

Colorado River Municipal Water District
 Regional Water Management Project
 Kick-Off Meeting
 August 17, 2004

Name	Representing	Phone	E-Mail
Royce Bodifera	City of Odessa	(432) 335-7090	odessaedit3@zol.com
Garson Letman	Alon USA BGS ARM	(432) 263-9504	gordon.lean@lonar.com
Kenny Scott	City of Big Spring	432-264-2393	kscott@ci.big-spring.tx.us
JAMES TAYLOR	City of Big Spring	432-264-2318	WATPE.ci.big-spring.tx.us
Ed Burdick	Odessa		
Charles Perry	CRMWD		
Al Zelt	CRMWD		
W.R. "Bro" Jell	CRMWD		
Eric J. Smith	CRMWD		
John Currie	CRMWD		
Tom Oberon	CoBS	264-2500	toadler@ci.big-spring.tx.us
Nancy Fungua	CoBS	264-2400	
Ray E. Kennedy	CRMWD		
Russ Mcburn	City of Big Spring	267-1413	rsmcnewen@ccom.net
Neil Blandford	DBS & A	(805) 822-9900	
John Burkstaller	"	(805) 822-9400	
Dick Gullman	CRMWD	432 262-4545	
Karenne Nash	Snyder, Jr Mayor	325-573-6777	
Danell Carleton	Snyder Co	325-573-3782	
Steve Hofer			

**Public Information Strategy
Development
June 21, 2005**

CRMWD Water Reclamation Project
Public Information Strategy Development
June 1, 2005

1. Project Description/Background
 - a. Potable Reuse
 - b. History of failed projects due to public opposition
2. Current Status
 - a. Feasibility Study Complete
 - b. Stakeholder/Public meetings scheduled July 19
3. Information media types
 - a. Public Presentation
 - b. Fact Sheets
 - c. Other
4. Themes & messages
 - a. Unplanned reuse widespread
 - b. Multiple barrier concept
5. Other strategies



MEETING MINUTES

Project: Regional Water Reclamation Project **Meeting Minutes No.**

Subject: Public Information Strategy

Recorded By: David Sloan

Date: June 21, 2005

Location: Telephone

Attendees: John Grant, Chris Wingert, Mike Morrison, Viqui Litman, Ignacio Cadena, David Sloan

The following reflects our understanding of the items discussed during the subject meeting. If you do not notify us within five working days, we will assume that you are in agreement with our understanding.

Item	Description	Action By
1.01	John Grant stressed the importance of being well-prepared for the meetings planned on July 19. He said all materials should be prepared by July 12 to allow time for final adjustments, etc. He would like an overall project fact sheet and a specific fact sheet for the Big Spring project. A list of Frequently Asked Questions will be prepared either for inclusion in the fact sheets or as a complementary handout.	VL, DWS
1.02	On July 19, a stakeholders meeting will be conducted in the late morning, consisting of the same group of city staff, elected officials and board members as the project kickoff meeting in August 2004. The presentation will be a shorter version of the presentation made to the CRMWD Operations Committee March 30. Lunch will be served to the stakeholders following the meeting. In the early afternoon, a public meeting will be conducted to present the project and explain it in laymen's terms. David asked if refreshments would be provided and John noted it would probably be good to provide some. Viqui suggested including bottled water, as an opportunity to compare the processes proposed for reclamation treatment with typical bottled water production.	
1.03	David asked if any contacts were established with any media. John said none had been to date. He noted the Midland article published last week was through contact with the City of Midland, and did not include any	



- input from CRMWD. John also noted that it may be some time before Midland was able to commit to additional effort on the reclamation project. He is inclined to keep the Odessa-Midland and Snyder projects on hold until there is more direction available from Midland.
- 1.04 David asked if there should be someone designated to receive calls on the project, for inclusion in the fact sheets, etc. John suggested Chris Wingert would be the appropriate person to receive all inquiries.
- 1.05 David asked if the District typically has project information on their website. John said they would put some information up, but indicated it would be preferable for FNI to develop a website for the project, so we can keep current information posted. Links should be provided from the reuse project site to CRMWD's site and vice versa. The website should also have a mechanism for receiving public comment and questions. John suggested creating a logo for the project to help generate a positive image. FNI will begin drafting possibilities for a logo. GSC, DWS
- 1.06 Viqui asked how notice of the meeting was being given. Chris noted the TWDB had specific requirements for notifying political subdivisions and placing a newspaper notice. CRMWD will also prepare a press release to provide additional notice for the meeting. Michelle Rhodes (CRMWD) will copy FNI on press releases. VL
- Viqui asked if there might be an opportunity to submit an op-ed piece for publication either prior to or concurrent with the public meeting. John suggested that most area papers would be happy to include such a piece as they were generally short-handed and needed material. FNI will prepare two pieces, one to run in advance of the meeting as an announcement and introduction, and a second to run immediately after the meeting to explain the project. VL
- David asked if Sherry Cordry at the TWDB had been notified of the meeting and Chris indicated she had.
- 1.07 FNI will submit draft fact sheets and draft Powerpoint presentations to Chris at the end of this week (6/24). This will allow CRMWD to review materials and provide comments to Mike Morrison in David's absence. David will be back in office July 12, but will also be checking messages at least 3 times per week and will be periodically available by cell phone. David requested a high resolution image of the CRMWD logo. Chris will e-mail the best image available. DWS
- CW

Feasibility Report to Stakeholders July 19, 2005

CRMWD Regional Water Reclamation Project



**Feasibility Study
Report to Stakeholders
July 19, 2005**

CRMWD

Colorado River Municipal Water District



Lake Alan Henry to Lake Thomas

PIPELINE

Capacity = 24 MGD.
27 Miles – 39/33 Inch
Max. Lift = 500 feet.
2 Pump Stations.

ESTIMATED COSTS

Debt Svc = \$1.9 mil/yr.
Electricity = \$1.1 mil/yr.
Royalty = \$10.5 mil/yr.
Cost = \$2.32 per kgal.
(to Lake Thomas only)

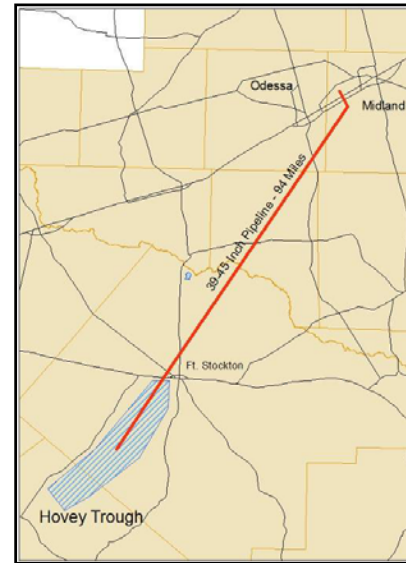

Hovey Trough to Terminal

PIPELINE

Capacity = 40 MGD.
94 Miles – 39/45 Inch
Max. Lift = 430 feet.
3 Pump Stations.

ESTIMATED COSTS

Capital Cost = \$272 Mil.
Debt Svc = \$17.7 mil/yr.
Electricity = \$3.0 mil/yr.
Cost = \$2.89 per kgal.

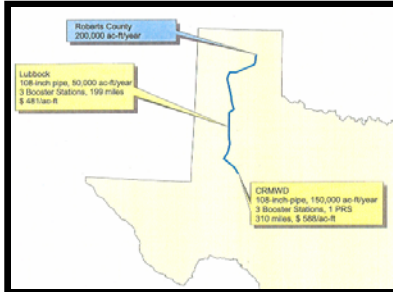

Roberts County to District

PIPELINE

Capacity = 187/140 MGD.
 198 Miles – 108 Inch
 109 Miles – 96 Inch
 Max. Lift = 800 feet.
 3 Pump Stations.

ESTIMATED COSTS

Capital Cost = \$1,031 Mil.
 Debt Svc = \$67.6 mil/yr.
 Electricity = \$22.4 mil/yr.
 Cost = \$2.09 per kgal.

Study by Mesa Water, Inc.

Assumes:

District takes 150,000 ac-ft per year.
 Lubbock takes 50,000 ac-ft per year

Cost of Reclaimed Water vs. Other Potential Sources

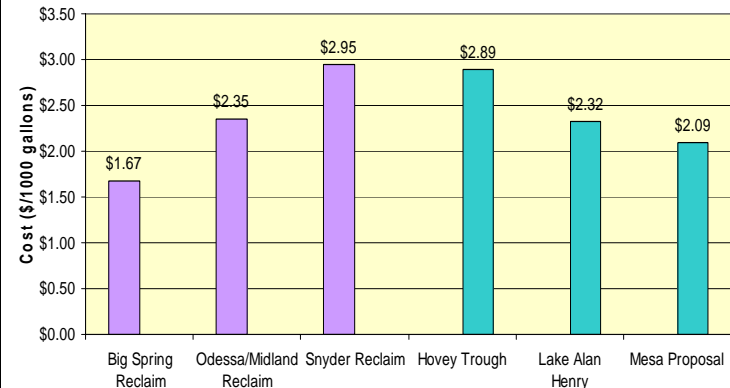

Indirect Potable Reuse



Feasibility Study Scope

- Inventory available wastewater effluent
- Prepare technology update on membrane filtration, demineralization & ASR
- Determine level of treatment required to meet regulations and public acceptance
- Investigate potential funding assistance
- Assess reuse feasibility for 3 projects: Big Spring, Snyder & Odessa-Midland



~~Un~~Planned Indirect Potable Reuse

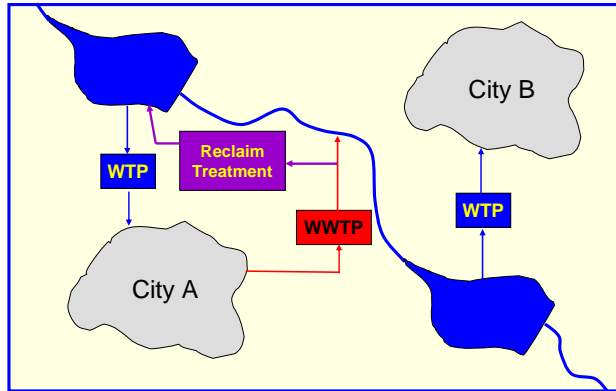

Water Quality Issues (Contaminants)

- Pathogens
 - Bacteria
 - Protozoans (*Giardia*, *Cryptosporidia*)
 - Viruses
- Emerging Contaminants
 - Pharmaceuticals, Endocrine Disruptors
 - Pesticides, Herbicides
 - NDMA, perchlorate
- Dissolved Solids (Salts, Hardness)

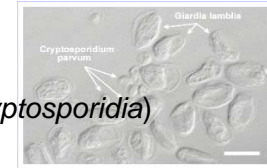

Multiple Barrier Approach

- Fundamental Concept in Public Water Supply:
 - Source Water Protection (Exclusion)
 - Chemical/Physical Treatment (Removal)
 - Chemical Disinfection (Kill Pathogens)
 - Distribution Residual (Prevent Regrowth)
- Use same concept in Potable Reuse
 - Use different types of Wastewater and Water treatment processes for protection



Other Potable Reuse Projects

- El Paso
- Tarrant Regional Water District
- North Texas Municipal Water District
- Wichita Falls
- Orange County (CA) Water District



El Paso Fred Hervey Project Indirect Potable Reuse - Groundwater

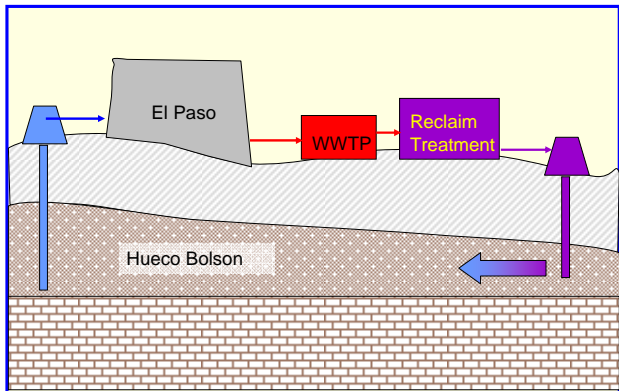

Tarrant Regional Water District

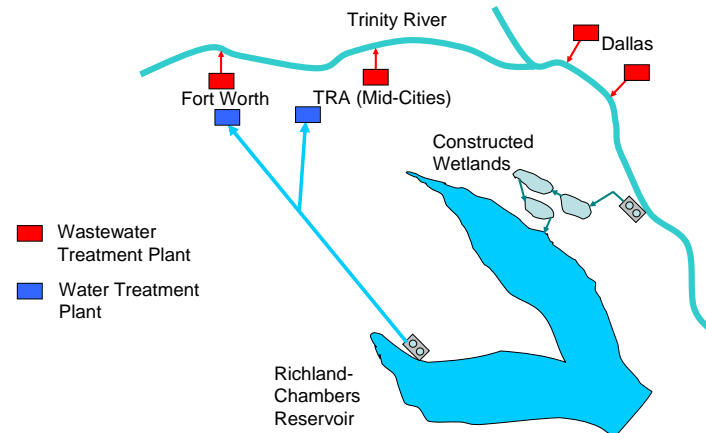

Orange County Water District

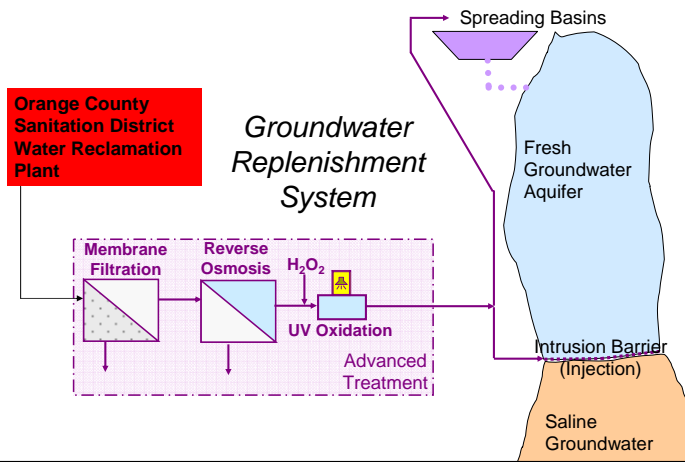

CRMWD Regional Water Reclamation Concept

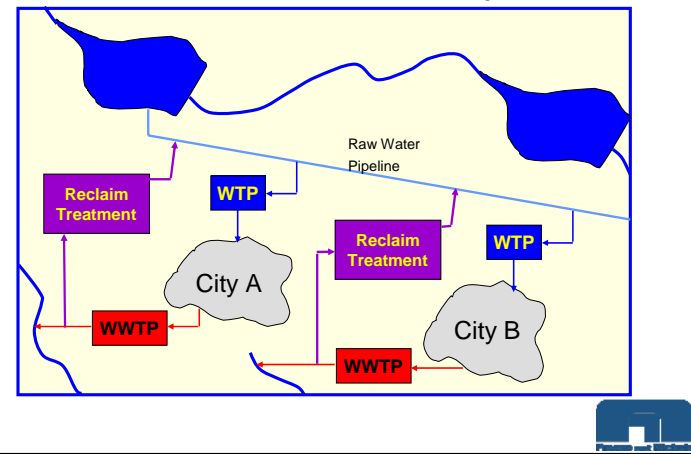

Regulatory Approval

- Initial Meeting with TCEQ last October
- Drinking Water Issues
 - Must not jeopardize provider's ability to meet Public Drinking Water Standards
 - Underground Injection must meet Drinking Water Standards prior to injection
- RO Concentrate Disposal
 - Surface Discharge
 - Underground Injection



Treatment Technology Update

- Membrane Treatment/Filtration
- Desalination
- Ultraviolet Disinfection/Oxidation



Membrane Technologies...

- Microfiltration - (MF)
- Ultrafiltration - (UF)
- Nanofiltration - (NF)
- Reverse Osmosis - (RO)



Filtration Range

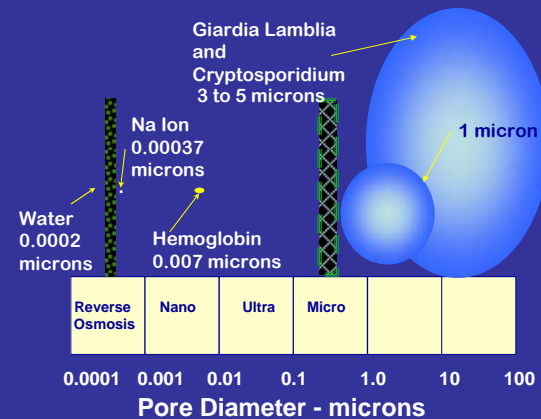

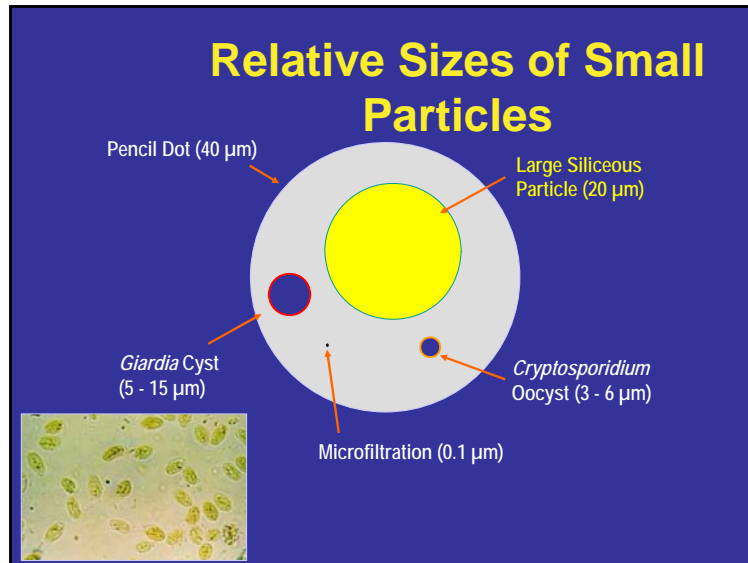

Membrane Filtration

- Microfiltration or Ultrafiltration
 - Similar Configurations
 - Difference in pore size & materials
- Remove virtually all particles
- Effectively remove protozoan pathogens (*Giardia* and *Cryptosporidia*)
- Provides effective pretreatment for desalination



Membrane Filtration (Microfiltration)

The photograph shows a large industrial facility, likely a water treatment plant, with numerous vertical membrane filtration modules arranged in rows. A metal staircase is visible in the foreground, and the floor is wet, suggesting a recent backwash cycle.



Backwash Recycle

- Membranes require frequent, short duration backwash to remove trapped particles
- Backwash can be stored and returned to influent for re-treatment
- Settled solids can be returned to sewer system or land applied



Desalination

- Removal of dissolved salts from water
 - Chloride
 - Sulfate
 - Hardness
- AKA: Desalting, Desalinization, Demineralization, Desal, Demin
- Preferred process is reverse osmosis (RO)



Reverse Osmosis (RO)

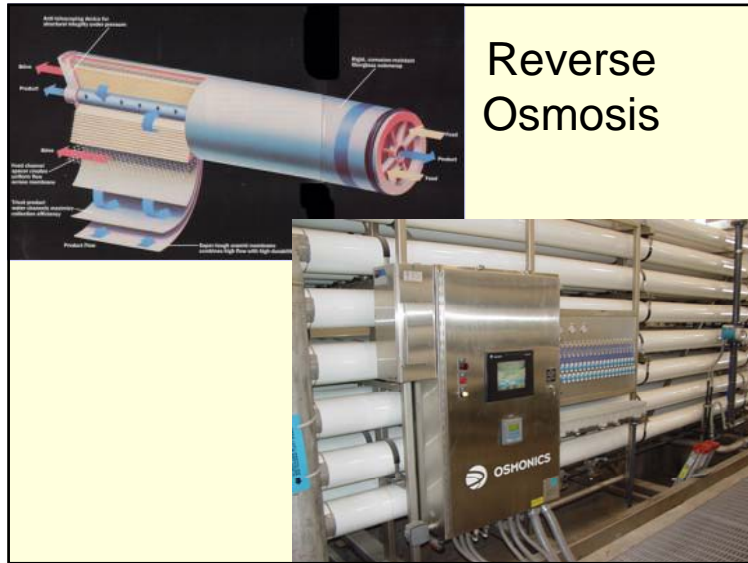
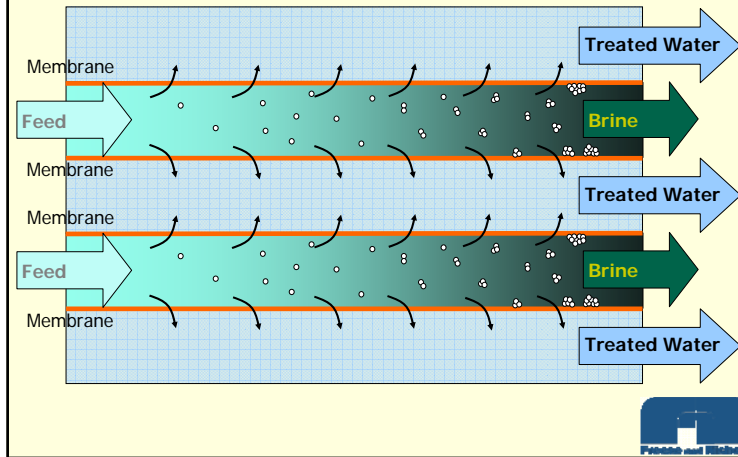

Reverse Osmosis

- Efficient removal of chlorides and other minerals
- Effective barrier to pathogens, including viruses
- Removes many organic contaminants, including certain pharmaceuticals, endocrine disruptors, pesticides, etc.
- Produces problematic waste stream



Ultraviolet Disinfection/ Advanced Oxidation

- Effective against all known pathogens (at various doses)
- Minimal byproduct creation and no residual stream
- Modest capital and operating cost
- Provides different mechanism from other processes
- Relatively new for drinking water treatment in U.S.

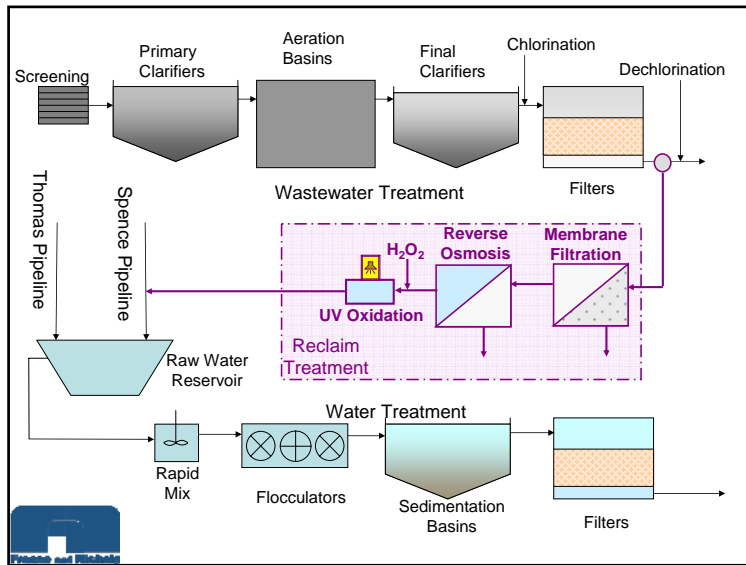

Contaminants vs. Barriers

Contaminant	Membrane Filtration	Reverse Osmosis	Ultraviolet Oxidation
Bacteria	Partial	Excellent	Excellent
Viruses	Partial	Excellent	Excellent
Protozoans	Excellent	Excellent	Excellent
Pharmaceut., Endocr. Disr.	No effect	Good	Probably Good
Pesticides	No effect	Good	Good
Salts	No effect	Good	No effect



Salinity vs. Other Sources

Source	Chloride (mg/l)	TDS (mg/l)
Big Spring Effluent	798	2257
Big Spring Reclaim	51	165
J.B. Thomas	73	392
E.V. Spence	575	1548
O.H. Ivie	440	1352
Secondary DW Stds.	300	1000



RO Concentrate Disposal

Concentrate Disposal Options

- Evaporation
- Discharge
- Underground Injection
- Conjunctive Use (w/Oil Operations)
- Secondary Recovery / Zero Liquid Discharge



Evaporation

- Evaporation rates high in service area, simple and natural approach
- Consistent high flow rates result in very large area requirements
- Some experimentation in progress with enhanced evaporation methods
- Evaporation ponds may require synthetic liners to prevent groundwater contamination



Surface Discharge



- Highly dependent on water quality of receiving stream
- TCEQ becoming more protective of stream salinity
- Beals Creek conducive to brine discharge



Underground Injection



- Used extensively for oil extraction wastes
- Environmentally accepted, but permitting lengthy and expensive
- Flows for municipal desalination much higher than for oil extraction
- Permitting and construction more costly for non-oil-related injection wells
- Initiatives to ease permitting in early stages



Beneficial Use/Co-disposal



- District has history and ongoing contracts for supplying saline water for flooding
- Several active well fields in Snyder and Odessa-Midland areas
- Time horizon of oil field flooding needs unknown
- Dependent on outside party for disposal
- May require significant transmission facilities and energy cost



Secondary Recovery/Zero Liquid Discharge

- Potential to increase project yield
- Reduced volume of waste
- Could consist of lime softening, brine concentrator and/or crystallizer
- Typically expensive to construct and operate
- Still requires disposal of something: sludge, concentrated brine or dry solids



Proposed Projects

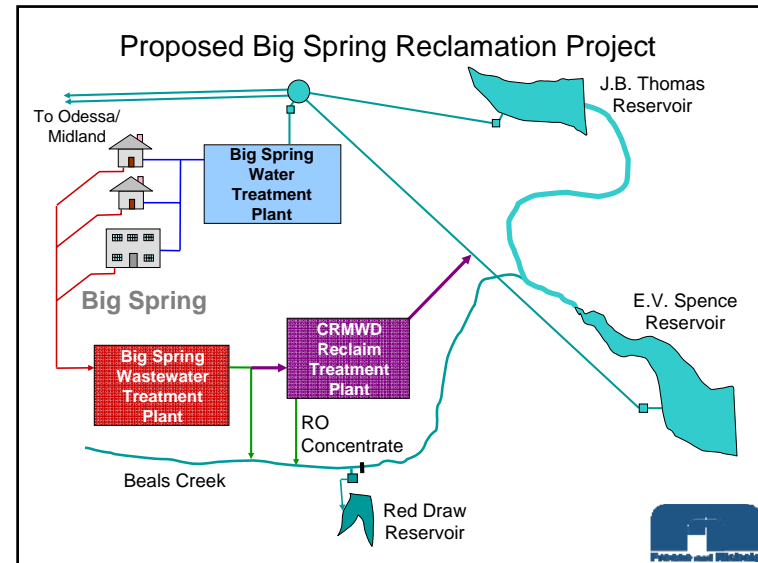

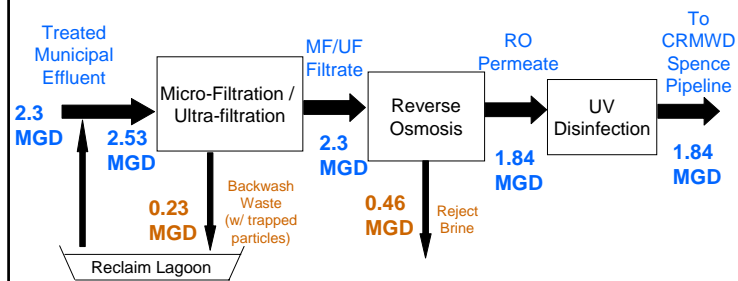

Big Spring Reclaim Quantities

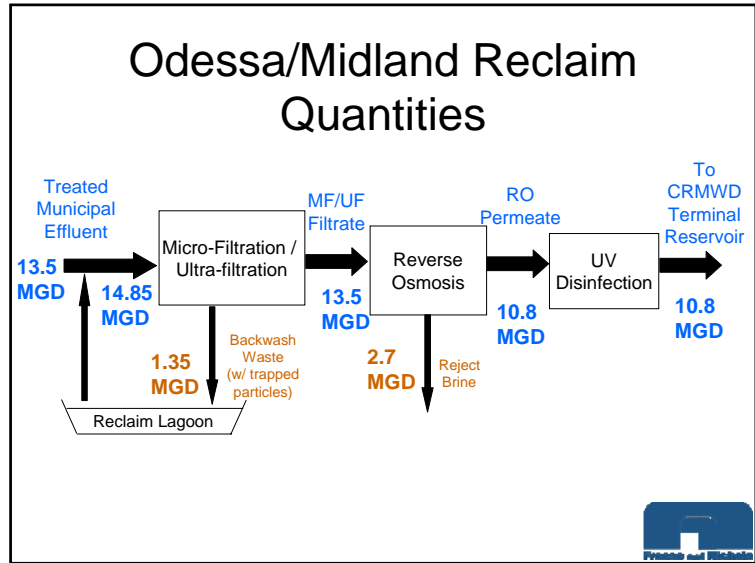
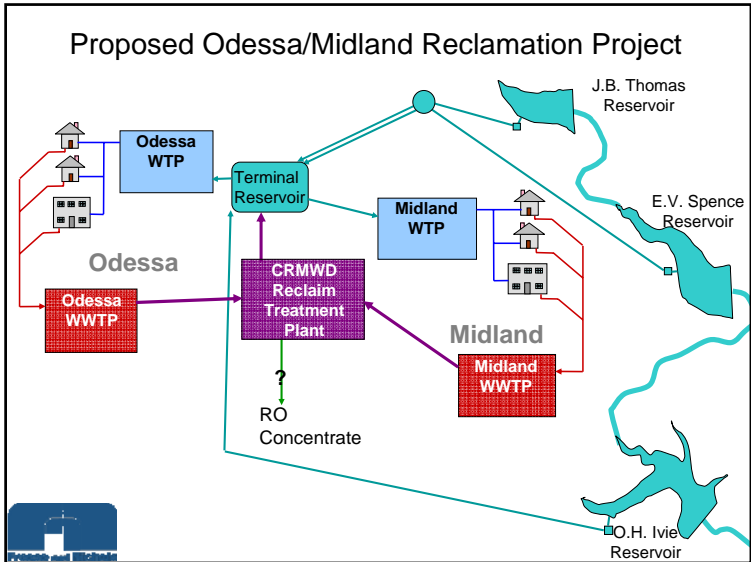
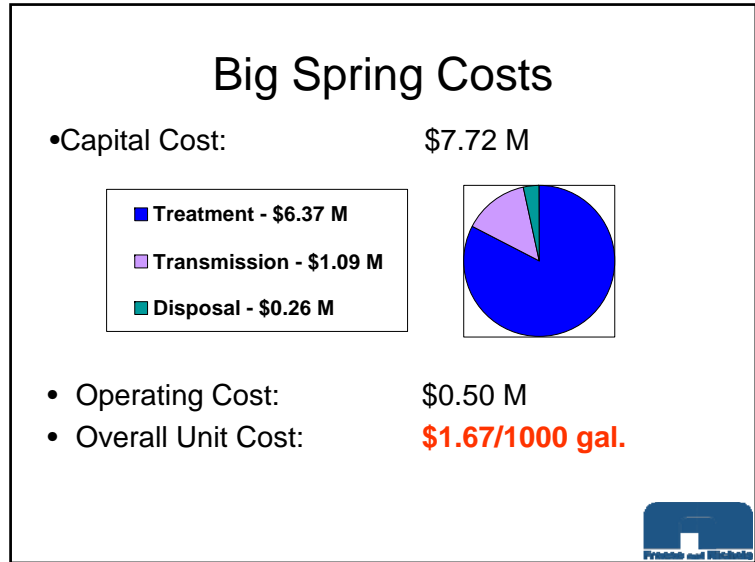

Disposal Issues

- Membrane filtration backwash
 - Recycle through lagoon
 - Send settled solids to WWTP
- Desalination Concentrate
 - Discharge to Beals Creek
 - Pump at Beals Creek PS to Red Draw Reservoir



- ## Regional vs. Individual
- Regional provides required capacity with less redundancy
 - Individual may reduce transmission and disposal costs
 - Terminal Reservoir provides good regional tie-in point with existing infrastructure
- 

Disposal Issues

- Membrane filtration backwash
 - Recycle through lagoon
 - Send settled solids to sewer or land apply
- Desalination Concentrate - Undetermined
 - Storage/Evaporation
 - Dedicated injection wells
 - Pump to Mabee Oil Field for Sale/Disposal
 - Secondary Recovery?



Odessa/Midland Costs

•Capital Cost: \$73.4 M

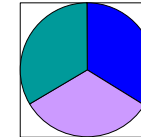
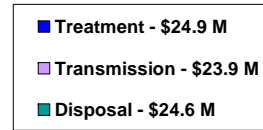

- Operating Cost: \$2.66 M
- Overall Unit Cost: **\$2.35/1000 gal.**
- Does not include additional secondary treatment capacity at Midland (\$10.6 M)



Proposed Snyder Reclamation Project

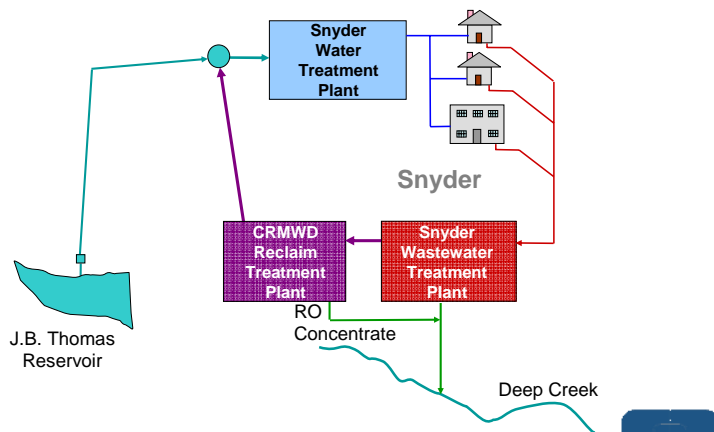

Snyder Reclaim Quantities

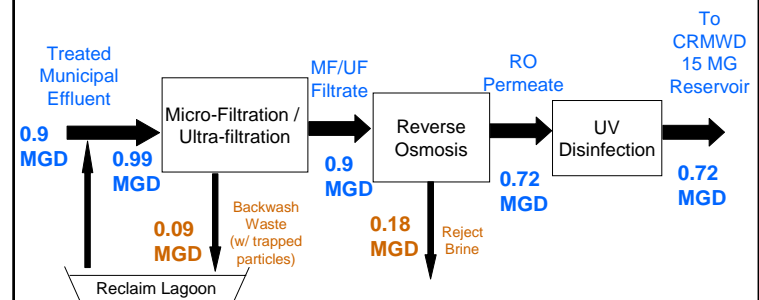

Disposal Issues

- Membrane filtration backwash
 - Recycle through lagoon
 - Send settled solids to WWTP
- Desalination Concentrate – Undetermined
 - Surface discharge assumed – limits available recovery
 - Alternative strategies:
 - Dedicated injection wells
 - Pump to Oil Field for Sale/Disposal



Snyder Costs

•Capital Cost: \$7.62 M

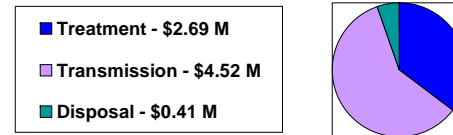

- Operating Cost: \$0.20 M
- Overall Unit Cost: **\$2.95/1000 gal.**
- Includes construction of replacement raw water storage reservoir near water treatment plant



Potential Funding Assistance



TWDB Regional Planning Grant

- \$ 150,000 State Participation in Planning Effort
- Establishes Texas Water Development Board as project partner



Potential Design/Construction Assistance

- TWDB Clean Water State Revolving Fund Loan Program
- TWDB Research Grant (Pilot Testing?)
- U.S. Bureau of Reclamation



Desalination Water Shortage Prevention Act

- Pending federal legislation (H.R. 1071)
- Would provide 10-year energy subsidy for desalination projects
- Could reduce unit cost of reclaimed water up to \$0.62/1000 gallons
 - (21-37% of projected costs)

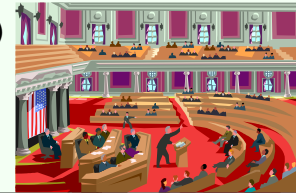

Conclusions *(Where do we go from here?)*



Feasibility

- Treatment Processes available to safely reclaim water for public supply
- No apparent legal or regulatory obstacles to reclamation
- Big Spring project appears cost-competitive with **existing** sources
- Other projects appear cost-competitive with other **new** sources

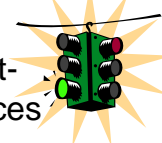

Big Spring Demonstration

- Favorable logistics:
 - Short transmission distance
 - Surface discharge of concentrate
 - Year-round blending viable
- Size appropriate for concept demonstration
- Close to home



Public Information & Acceptance

- Public support is critical
- Initial public meeting this afternoon
- Op-ed articles and website available for ongoing education
- City officials and staff will be important ambassadors for public opinion
- Direct questions & feedback to Chris Wingert, CRMWD



Next Steps

- Additional Conceptual Evaluations
 - Odessa/Midland project configuration
 - Concentrate disposal alternatives
 - ASR feasibility
- Big Spring Project Implementation
 - Preliminary Design
 - Permitting
 - Pilot Testing
 - Final Design



REGIONAL WATER RECLAMATION PROJECT MEETING

Dora Roberts Community Center - 100 Whipkey Drive, Big Spring, TX 79720

Tuesday, July 19, 2005 at 10 a.m.

Name	Representing	Phone	E-Mail
JOHN GRANT	CRMWD	432-267-6341	JGRANT@CRMWD.ORG
JIM BROWN	MIDLAND WAT. RES. COM	432 683 4800	JBROWN@SBCGLOBAL.NET
Mike Morrison	Freese and Nichols, Inc.	817-735-7200	mym@freese.com
David Sloan	Freese & Nichols	817-735-7277	dws@freese.com
Clif Talker	CRMWD	432-264-7105	
Dubois McReynolds	City of Odessa	432-355-4625	dmcrayno@ci.odessa.tx.us
Tim Weaver	CRMWD		jweaver@ci.bigspring.tx.us
RAY KENNEDY	CRMWD		RAY.K@PARKINSURANCE.COM
JAMES TAYLOR	COBS WOTC	432-264-2394	
Kenny Scott	COBS	432-264-2393	kscott@ci.bigspring.tx.us
Talker Clifton	COBS	432-264-2500	talker@ci.bigspring.tx.us
Butch Davis	COBS	806.473.2200	bdavis@team-ps.com
John Kellen	Big Spring	806 473 2200	JKelley@team-ps.com
Steve Hefner	CRMWD/Midland		
Jeff Stubbarts	COBS	432-264-2389	WTP@ci.bigspring.tx.us
Frances Allen - Nash	Snyder Mayor	325-573-6717	
BRO HILL	CRMWD ODessa		
Charles Perry	CRMWD Odessa	432-563-3225	cperry@perrymanagement.com
SIM PURCELL	CRMWD - Big Spring	432 264-2150	
Chris Wingard	CRMWD	267-6341	
Russ McEwen	City of Big Spring	267-1413	rncewen@percom.net
GARY FUQUA	City of Big Spring	264-2400	gfucua@ci.bigspring.tx.us
JEAN GAYLE	City of Snyder	325-573-3520	jsgayle@ci.snyder.tx.us
Okie Thornton	CRMWD	432-267-6341	ok Thornton@CRMWD.org
WENDELL BARBER	CRMWD	432-267-6341	wbarber@CRMWD.org

Feasibility Report to Public July 19, 2005

CRMWD Regional Water Reclamation Project

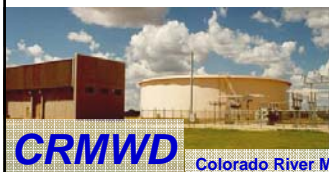

Public Information Meeting
July 19, 2005

CRMWD

Colorado River Municipal Water District



CRMWD

Colorado River Municipal Water District

COLORADO RIVER MUNICIPAL WATER DISTRICT

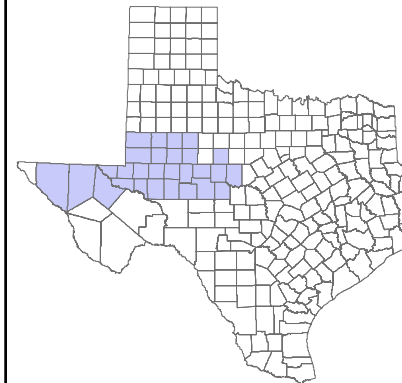

MEMBER CITIES:

Odessa
 Big Spring
 Snyder

CONTRACT CITIES:

Midland
 San Angelo
 Abilene
 Stanton
 Robert Lee
 Pyote
 Grandfalls

28 County CRMWD Operational Area

CRMWD

Colorado River Municipal Water District

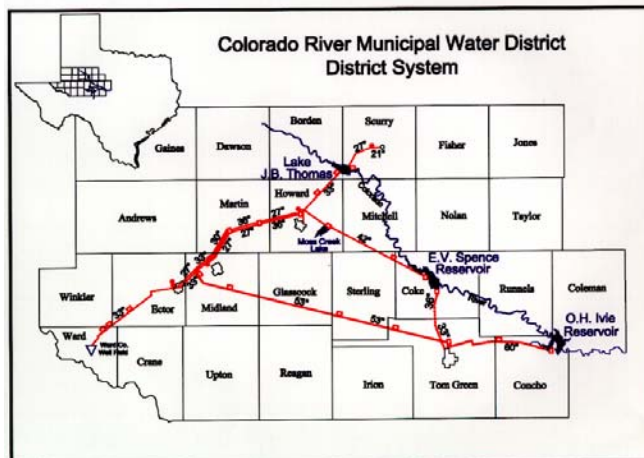

CRMWD

Colorado River Municipal Water District

CRMWD Municipal Deliveries

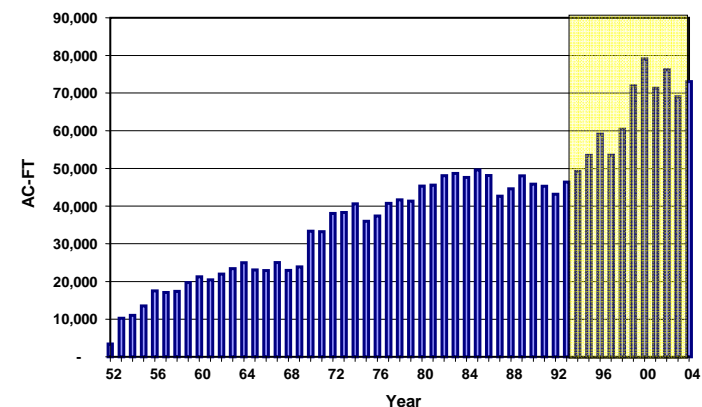

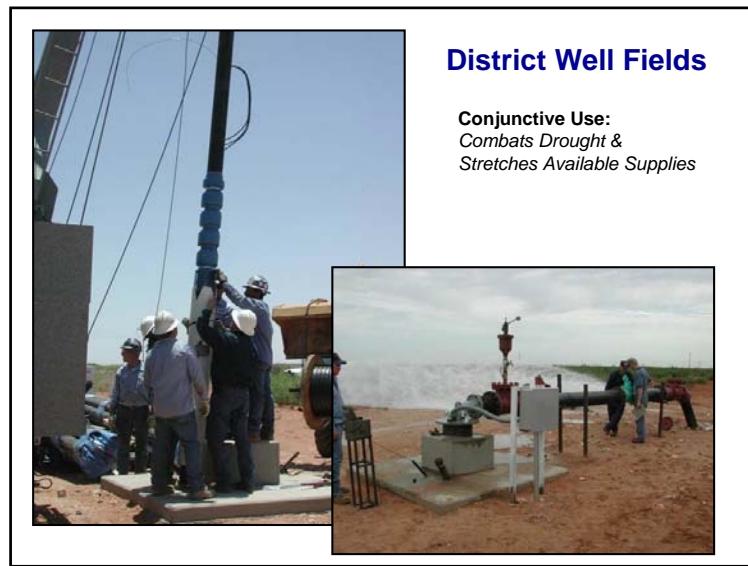
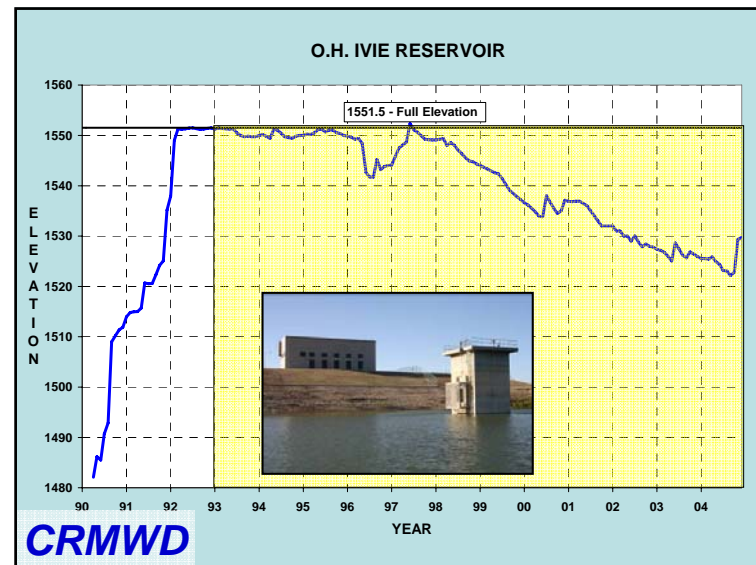
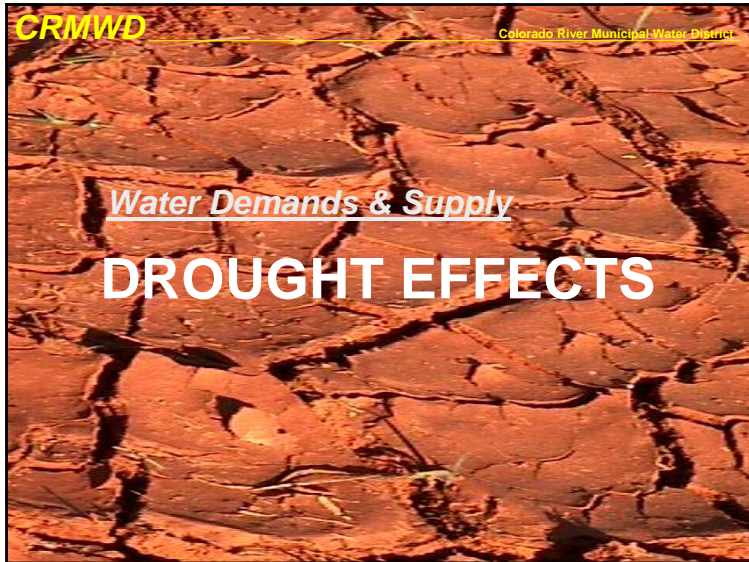



Reclamation (or Reuse)

What is it?

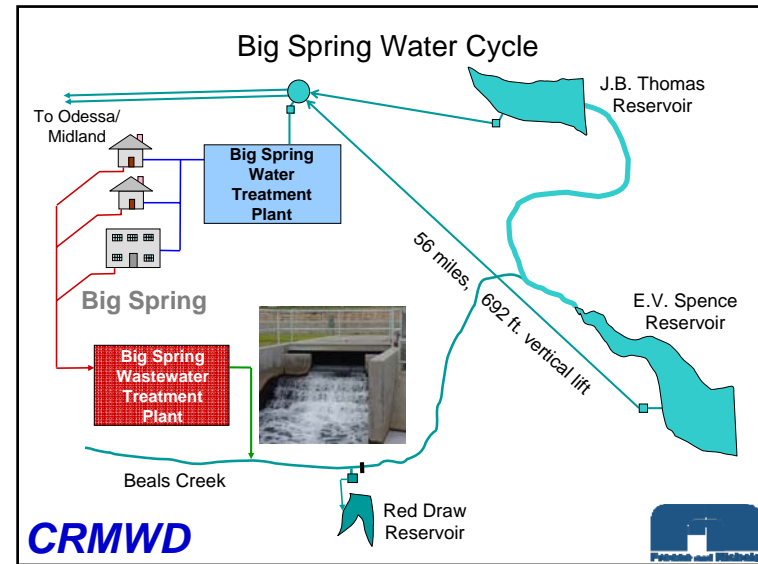
CRMWD



Water Reclamation

- AKA: Water recycling, water reuse 
- Treating wastewater (sewage) to a usable quality and making appropriate use of it
- Quality required depends upon type of use

CRMWD



Types of Water Reclamation

- Landscape Irrigation – Golf Courses, Parks, Campuses, etc.
- Power Plant Cooling Water 
- Construction Dust Control
- Industrial Process Water
- Agricultural Irrigation
- Water Supply Augmentation 

Direct Non-potable Reuse

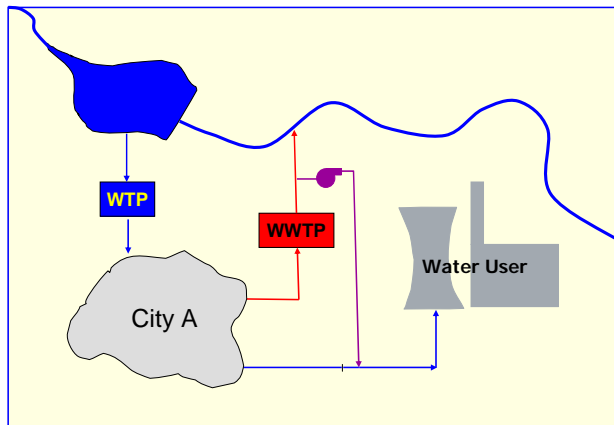

~~Un~~Planned Indirect Potable Reuse

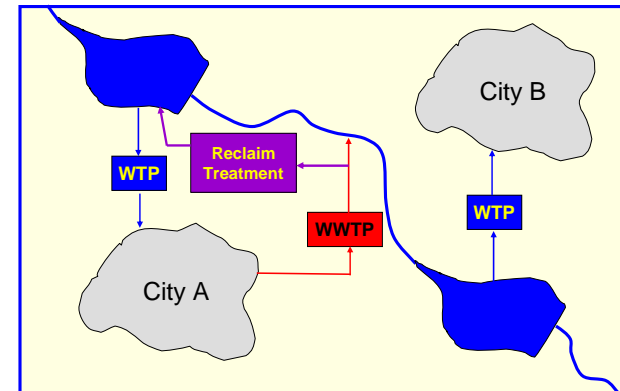

CRMWD



Why Water Reclamation?

- Readily available source
- Already pumped to the cities – other sources are far away
- Drought-proof supply
- As cities grow, supply increases
- Better quality after treatment than raw lake water
- Use 100% of the water 100% of the time

CRMWD



Potential Water Sources

- Lakes
- Groundwater
- Conservation
- Reuse
- Desalination of brackish water

CRMWD



Is Reclamation Safe?

CRMWD



What's different about wastewater?

- Pathogens (organisms)
 - Bacteria
 - Protozoans (*Giardia*, *Cryptosporidia*)
 - Viruses
- Emerging Contaminants
 - Pharmaceuticals, Endocrine Disruptors
 - Pesticides, Herbicides
 - Industrial chemicals
- Dissolved Solids (Salts, Hardness)

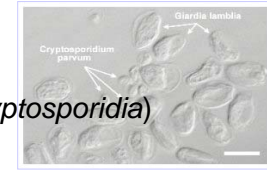

Multiple Barrier Approach



- Fundamental concept in public water supply
- Provide repeated opportunities to remove contaminants
- Don't put all eggs in one basket



CRMWD

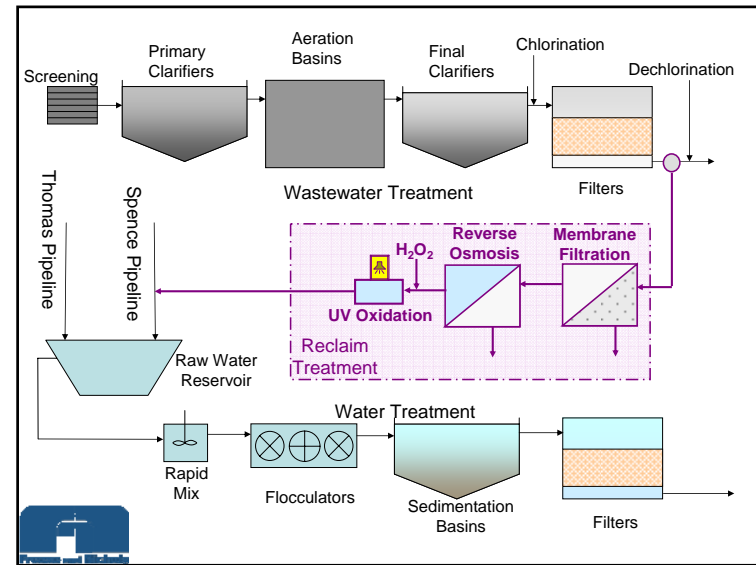

Who else is doing reclamation for Water Supply Augmentation?

- **El Paso***
- Tarrant Regional Water District
- North Texas Municipal Water District
- Wichita Falls
- **Orange County (CA) Water District***
- *Many other un-planned cases*

**Already operating long-term*

CRMWD



El Paso Fred Hervey Project Indirect Potable Reuse - Groundwater

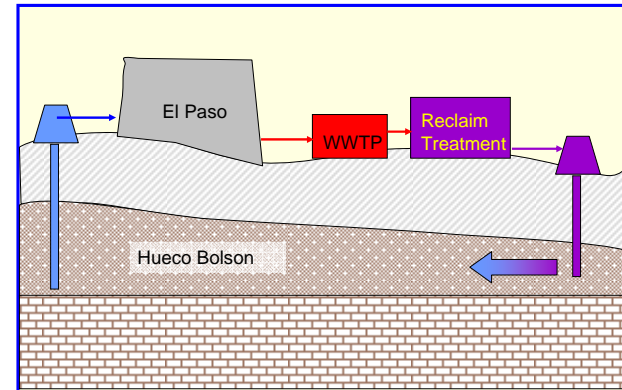

Tarrant Regional Water District

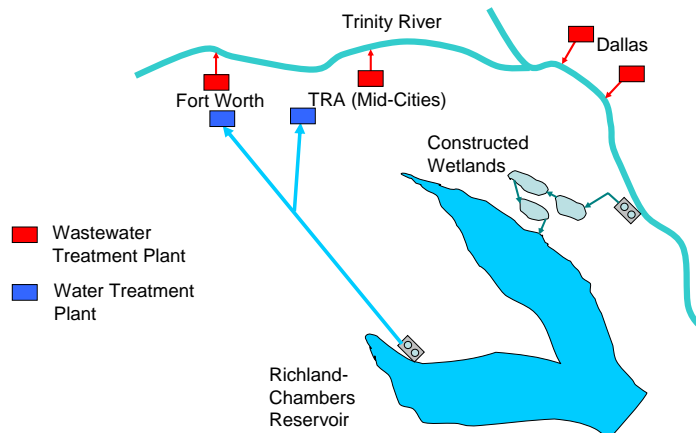

Orange County Water District

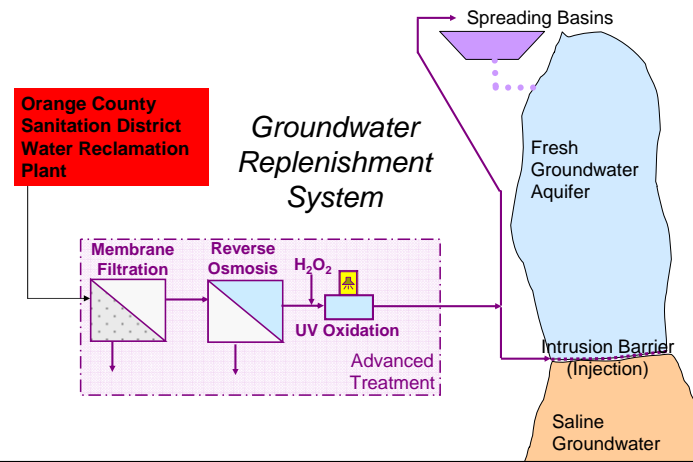

Proposed Treatment Processes

- Membrane Treatment/Filtration
- Reverse Osmosis (RO)
- Ultraviolet Disinfection & Oxidation

CRMWD



Membrane Filtration Range

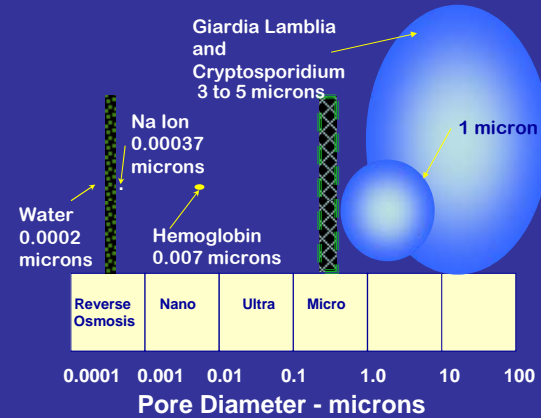

Relative Sizes of Small Particles

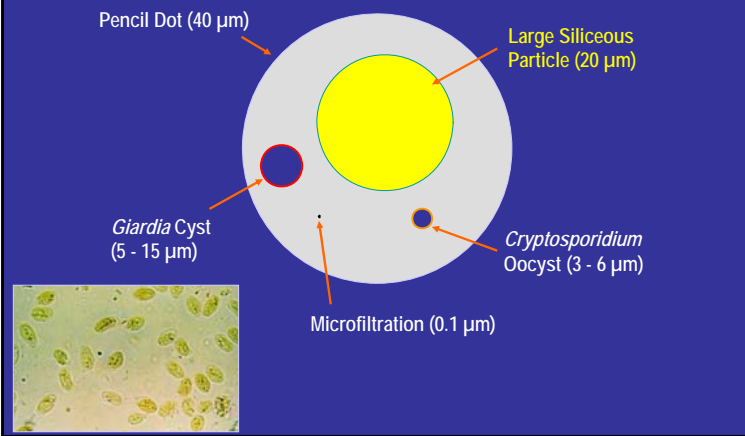

Membrane Filtration (Microfiltration)



Desalination

- Removal of dissolved salts from water
 - Chloride
 - Sulfate
 - Hardness
- AKA: Desalting, Desalinization, Demineralization, Desal, Demin
- Preferred method: Reverse Osmosis (RO)

CRMWD



Reverse Osmosis (RO)

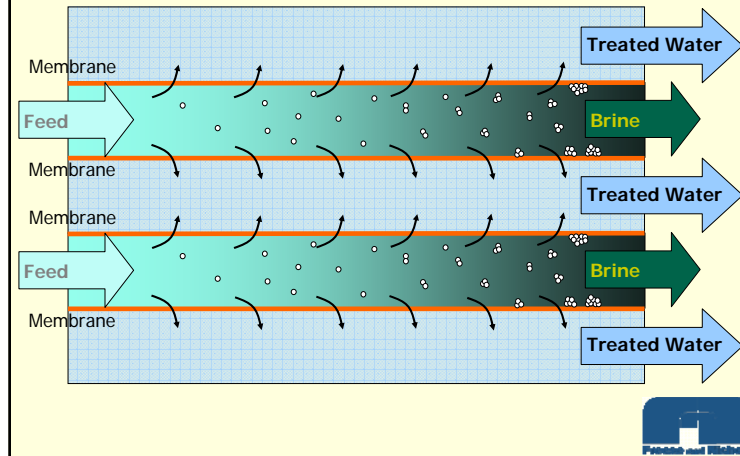

Reverse Osmosis

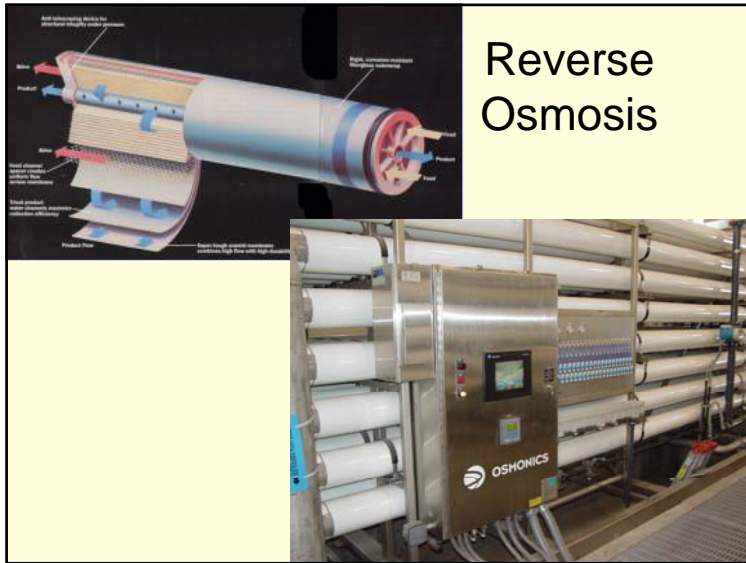

Reverse Osmosis

- Efficient removal of chlorides and other minerals
- Effective barrier to pathogens, including viruses
- Removes many organic contaminants, including certain pharmaceuticals, endocrine disruptors, pesticides, etc.
- Typical process used for producing bottled water

CRMWD



Ultraviolet Disinfection/ Advanced Oxidation

- Sterilizes water
- Provides different type barrier from other processes
- Breaks down chemicals which pass through membranes



CRMWD



Proposed Big Spring Project

CRMWD

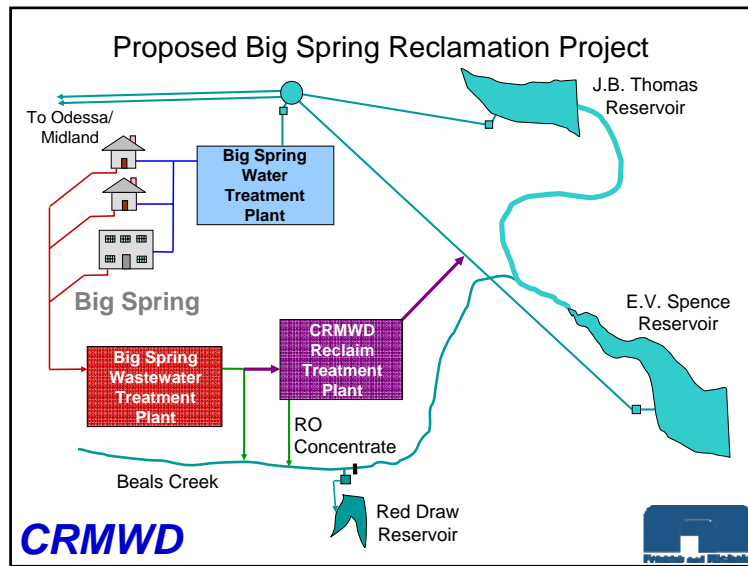

CRMWD



How Much Does it Cost?

•Capital Cost: \$7.72 M

■ Treatment - \$6.37 M
 ■ Transmission - \$1.09 M
 ■ Disposal - \$0.26 M

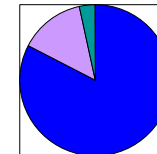

- Operating Cost: \$0.50 M per year
- Overall Unit Cost: **\$1.67/1000 gal.**

CRMWD



Cost of Reclaimed Water vs. Other Potential Sources

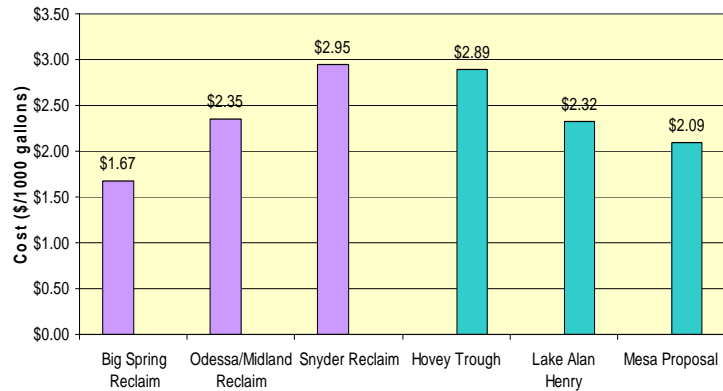

TWDB Funding Assistance

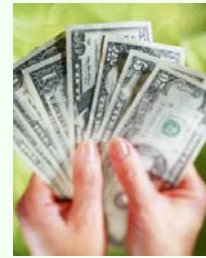

Regional Planning Grant

\$ 150,000 State Participation
in Planning Effort

CRMWD



Next Steps

- Preliminary Design
- Permitting
- Pilot Testing
- Final Design



What if I have Questions?

- Reclamation website:
WWW.CRMWD.org
Go to Reclamation
– Website provides updated information and channel for questions and comments
- Contact Chris Wingert, CRMWD
Assistant General Manager, 432-267-6341
- E-mail Chris: cwingert@CRMWD.org

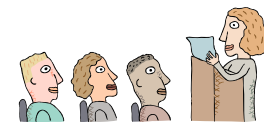

CRMWD



Water for Our Future: Reclaimed Water

New Options vs. Limited Supply

Even in the best of times, water is scarce in West Texas. Our reservoirs have not been full in years; and, in the current drought, many municipalities have been forced to regulate and even restrict water use.

A Feasible Plan

The Colorado River Municipal Water District (CRMWD) and the Regional Water Planning Group have studied many options for increasing and improving area water supplies. A feasibility study conducted by the engineering firm of Freese and Nichols has found that reclaiming water is a practical way to improve water quality and augment our supply. It makes sense for all of us in the Permian Basin to consider water reclamation as part of the CRMWD's water supply strategy.

Scarce and Salty

We know that in West Texas, our water is scarce, and it contains high levels of minerals, referred to as salts. That is why so many residents and businesses have installed filter systems to improve the taste of our water, and make it "softer."

Water reclamation can help assure that our future includes a good water supply *and* a supply of good water.

Water Treatment: A Partnership with Nature

All water must be treated before it can be sent to homes and businesses for drinking, bathing and other common uses. Traditionally, in our area, water for consumption—potable water—comes from wells (groundwater) or lakes (surface water). The Colorado River Municipal Water District supplies raw (untreated) water from three lakes to municipalities for service to more than 450,000 people. Those municipalities—like our member cities of Big Spring, Odessa and Snyder—and customers like Midland and San Angelo, operate treatment plants that purify the water to meet federal and state regulations for drinking water.

These municipalities also operate wastewater treatment plants, which collect and treat wastewater from homes and businesses. Using traditional treatment methods, these cities process the wastewater and discharge it into streams or use it for irrigation. Natural processes then take over.

The treated wastewater is diluted as it blends with water in streams and aquifers. Living organisms break down chemicals. The water is exposed to air and sunlight. It flows over rocks and through soil that filter impurities. These natural processes are all part of the water cycle. Dilution, filtration, and exposure to air and light help clean the water until it flows to another reservoir, or trickles into a well-field where it again will be collected and purified to use in homes and businesses.

Water Reclamation: Accelerating the Process

Essentially, water reclamation accelerates the natural processes of filtration, exposure to air and light, and dilution. With a water reclamation system, treated water that we now discharge to flow away to other places becomes a resource that, through acceleration, can be purified for our use, meeting the standards for drinking water established by the Texas Commission for Environmental Quality and the U.S. Environmental Protection Agency.



Water for Our Future: 5 Steps to Reclaimed Water

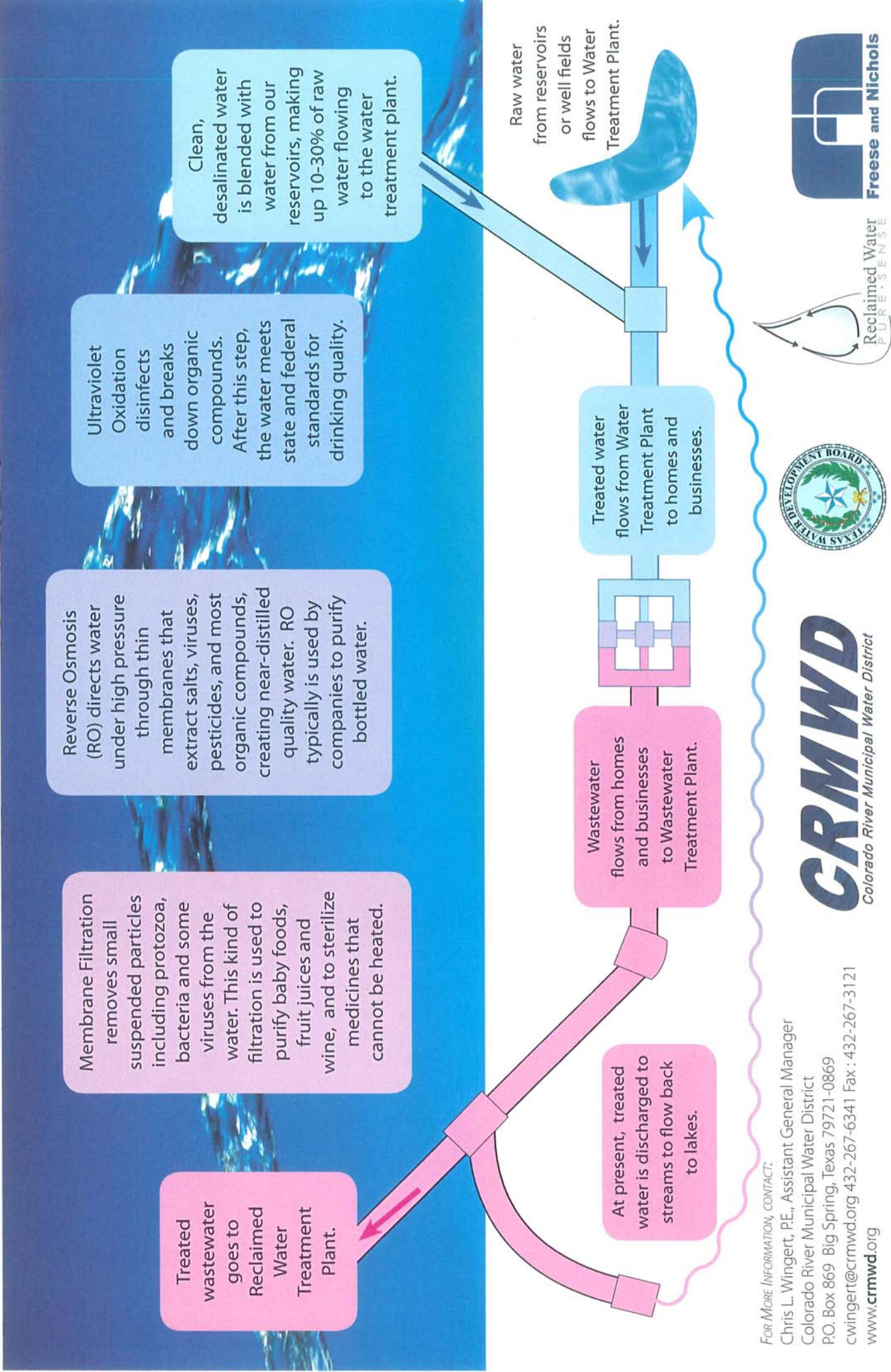

Treated wastewater goes to Reclaimed Water Treatment Plant.

Membrane Filtration removes small suspended particles including protozoa, bacteria and some viruses from the water. This kind of filtration is used to purify baby foods, fruit juices and wine, and to sterilize medicines that cannot be heated.

Reverse Osmosis (RO) directs water under high pressure through thin membranes that extract salts, viruses, pesticides, and most organic compounds, creating near-distilled quality water. RO typically is used by companies to purify bottled water.

Ultraviolet Oxidation disinfects and breaks down organic compounds. After this step, the water meets state and federal standards for drinking quality.

Clean, desalinated water is blended with water from our reservoirs, making up 10-30% of raw water flowing to the water treatment plant.

Wastewater flows from homes and businesses to Wastewater Treatment Plant.

At present, treated water is discharged to streams to flow back to lakes.

Treated water flows from Water Treatment Plant to homes and businesses.

Raw water from reservoirs or well fields flows to Water Treatment Plant.

FOR MORE INFORMATION, CONTACT:
 Chris L. Wingert, P.E., Assistant General Manager
 Colorado River Municipal Water District
 P.O. Box 869 Big Spring, Texas 79721-0869
 cwingert@crmwd.org 432-267-6341 Fax: 432-267-3121
 www.crmwd.org



CRMWD
 Colorado River Municipal Water District



5 Steps to Reclaimed Water



Treated wastewater goes to Reclaimed Water Treatment Plant



Membrane Filtration removes small particles



Reverse Osmosis (RO) removes salt and micropollutants



Ultraviolet Oxidation provides backup disinfection



Clean, desalinated water is blended with water from reservoirs before final treatment by cities

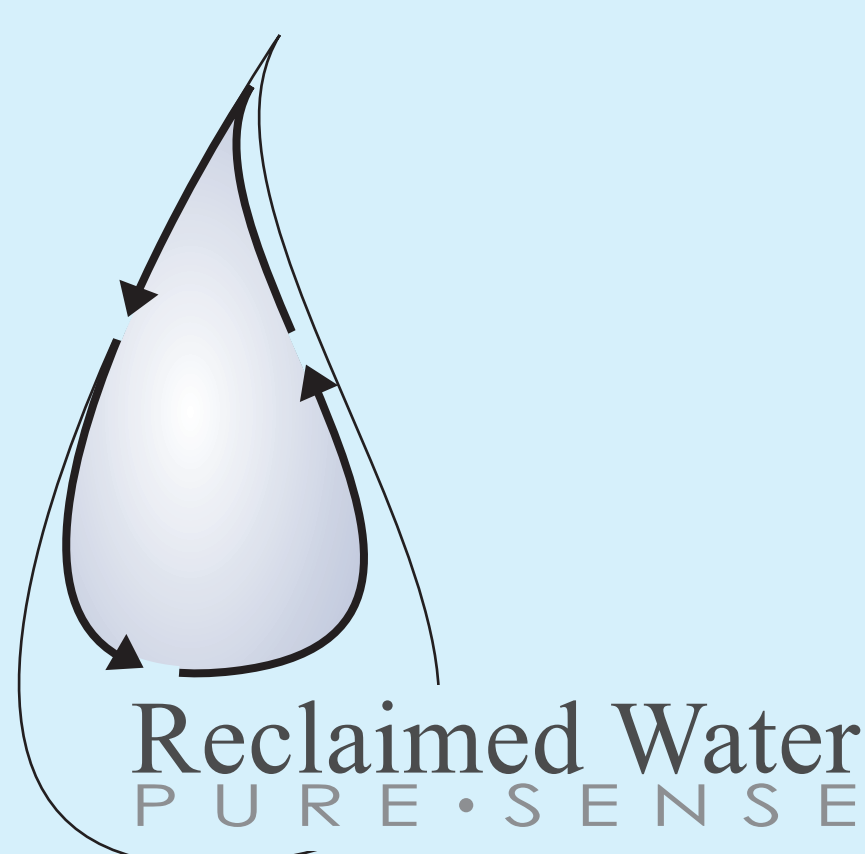

Learn More at www.CRMWD.org

Funded in part through a Texas Water Development Board Regional Planning Grant.

Why Water Reclamation?

We need the water!

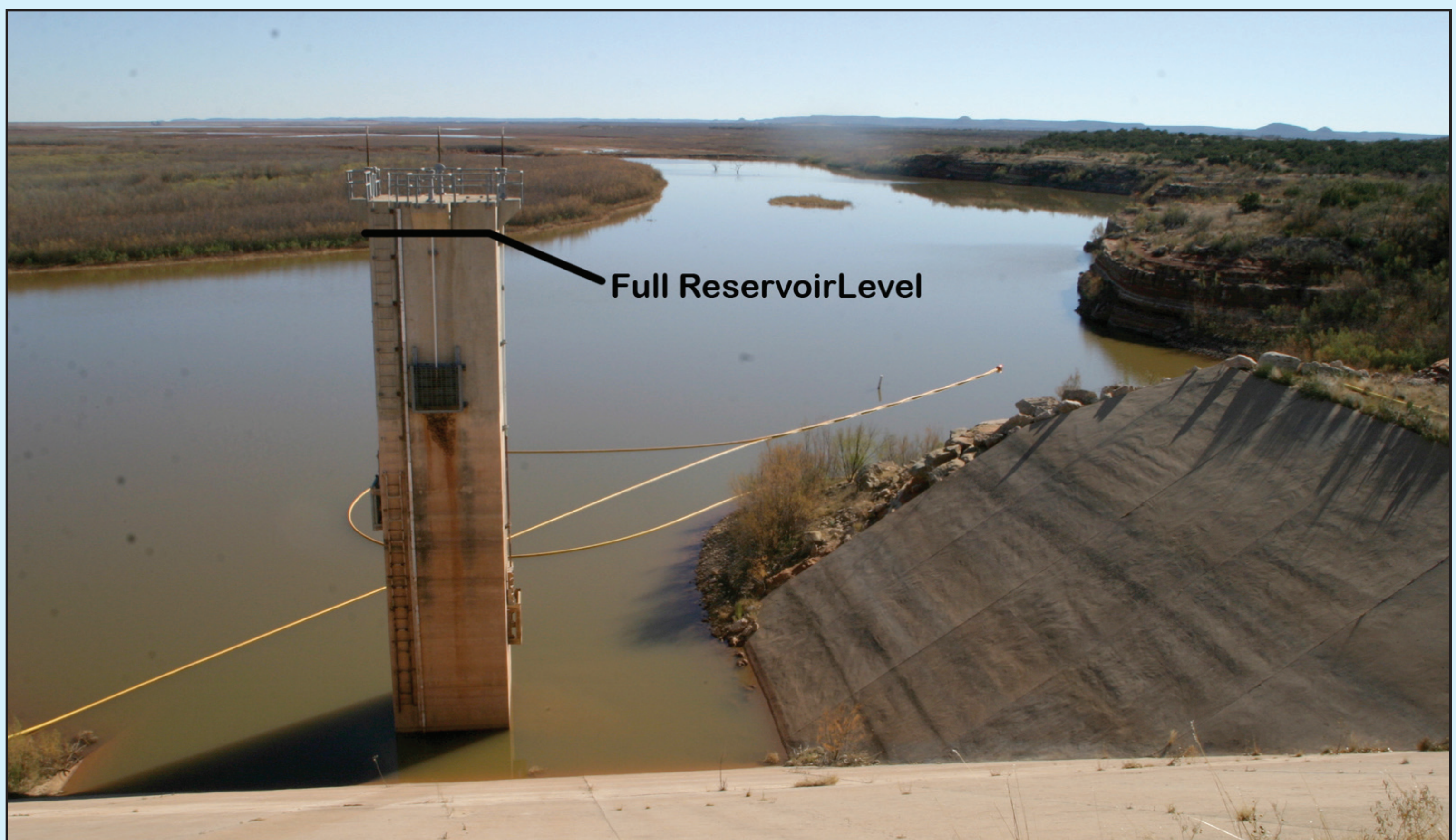

E.V. Spence Reservoir



Source is already at hand - other potential sources are far away



Drought-proof supply - always available



Proposed treatment provides safer, better quality water than existing supply

**Water for
Our Future**

Reclaimed Water

3 Projects could provide up to 13,000,000 gallons/day of bottled-quality water to the Permian Basin:



Big Spring



Odessa-Midland



Snyder

Typical Water Reclamation System

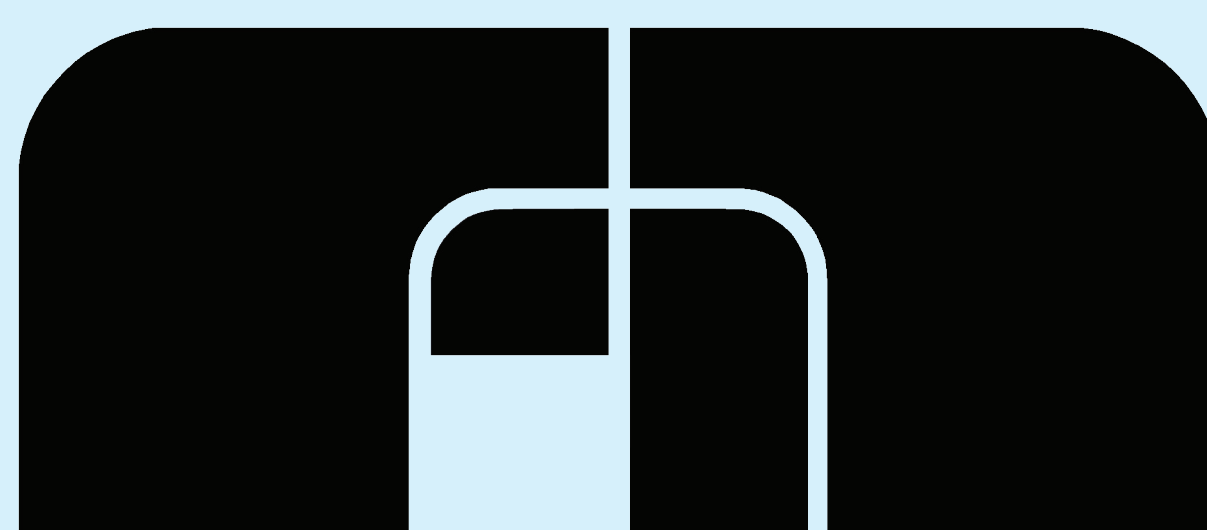
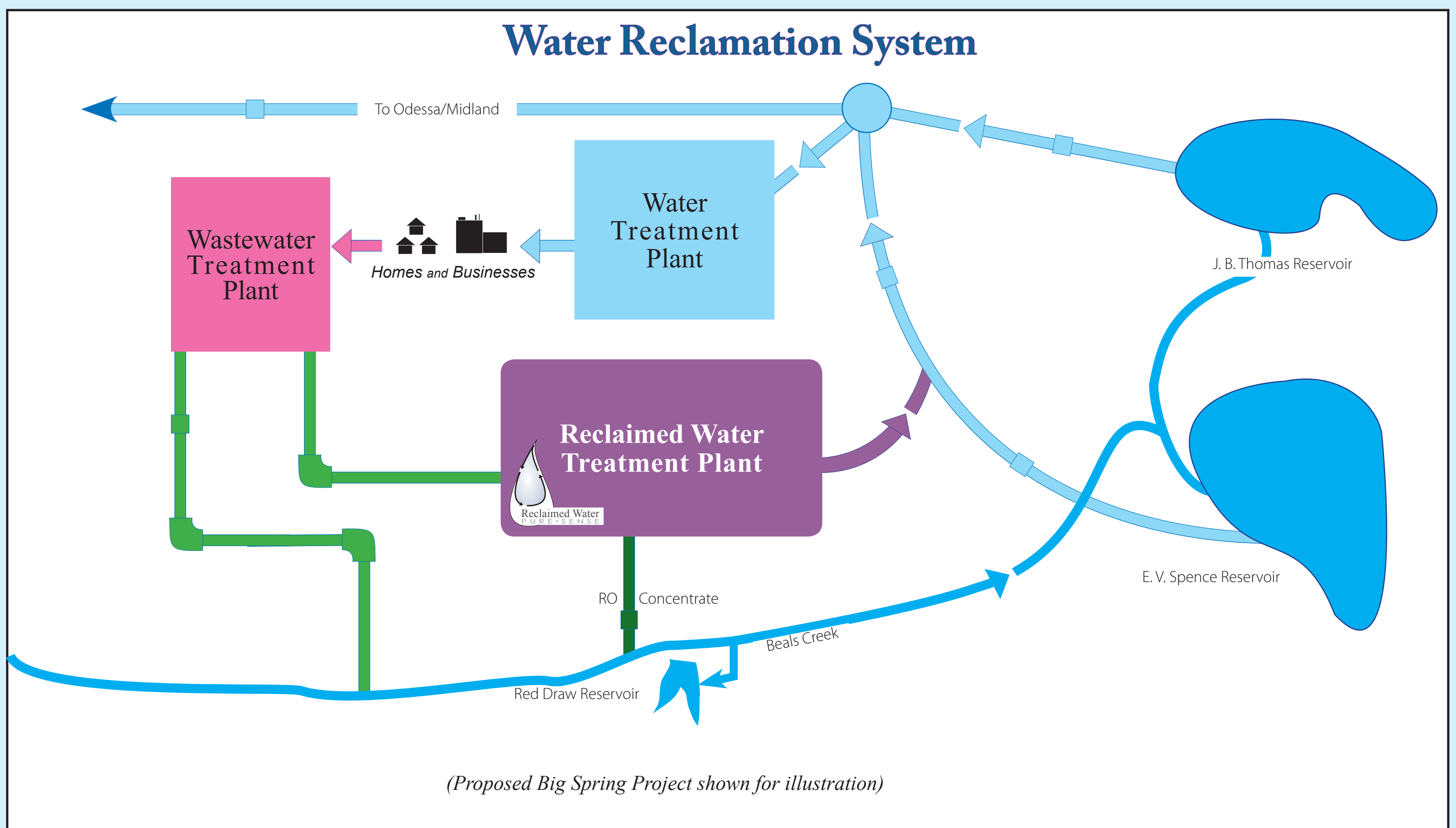

Freese and Nichols

Preliminary Design Report to Public October 3, 2007

COLORADO RIVER MUNICIPAL WATER DISTRICT
TEXAS WATER DEVELOPMENT BOARD
PUBLIC MEETING ON THE
PRELIMINARY DESIGN REPORT
BIG SPRING WATER RECLAMATION PROJECT
1:30 p.m., Wednesday, October 3, 2007
Dora Roberts Community Center
100 Whipkey Drive, Big Spring, Texas

A G E N D A

1. Welcome & Project Overview
2. Water Demands & Supplies
3. Report Discussion
 - A. Municipal Water Cycle
 - B. Non-Municipal Water Reclamation
 - C. Municipal Water Reclamation
 - D. Treatment Technologies Update
 - E. Energy Issues
 - F. Probable Project Costs
 - G. Implementation
 - H. Summary
4. Closing Comments & Questions

Big Spring Regional Water Reclamation Project



Public Meeting – Preliminary Design Report
October 3, 2007

CRMWD Colorado River Municipal Water District



Public Meeting – Preliminary Design Report

- 1. Welcome & Project Overview**
John Grant – General Manager CRMWD
- 2. Water Demands & Projections**
Chris Wingert – CRMWD
- 3. Project Discussion**
David Sloan – F&N
- 4. Closing Comments & Questions**
John Grant – General Manager CRMWD

Public Meeting – Preliminary Design Report

- 1. Welcome & Project Overview**
John Grant – General Manager CRMWD
- 2. Water Demands & Projections**
Chris Wingert – CRMWD
- 3. Project Discussion**
David Sloan – F&N
- 4. Closing Comments & Questions**
John Grant – General Manager CRMWD

CRMWD

Colorado River Municipal Water District

COLORADO RIVER MUNICIPAL WATER DISTRICT

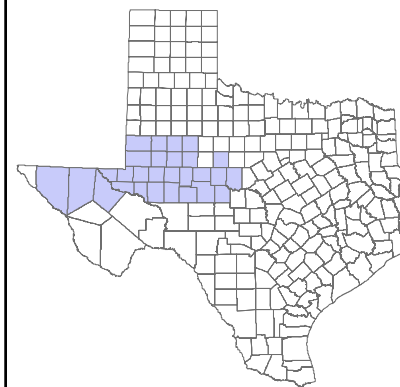

MEMBER CITIES:

Odessa
Big Spring
Snyder

MUNICIPAL CUSTOMERS:

Midland
San Angelo
Abilene
Stanton
Robert Lee
Pyote
Grandfalls
Millersview-Doole WSC

28 County CRMWD Operational Area

Meeting Municipal Water Needs



3 Major Reservoirs



4 Well Fields



23 Pump Stations
600 Miles of Pipeline



3 Member Cities
7 Customer Cities
1 W. S. C.

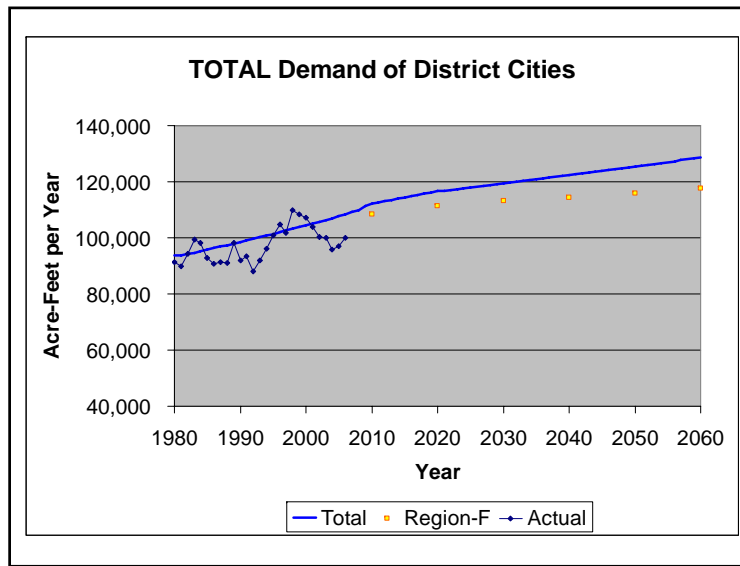
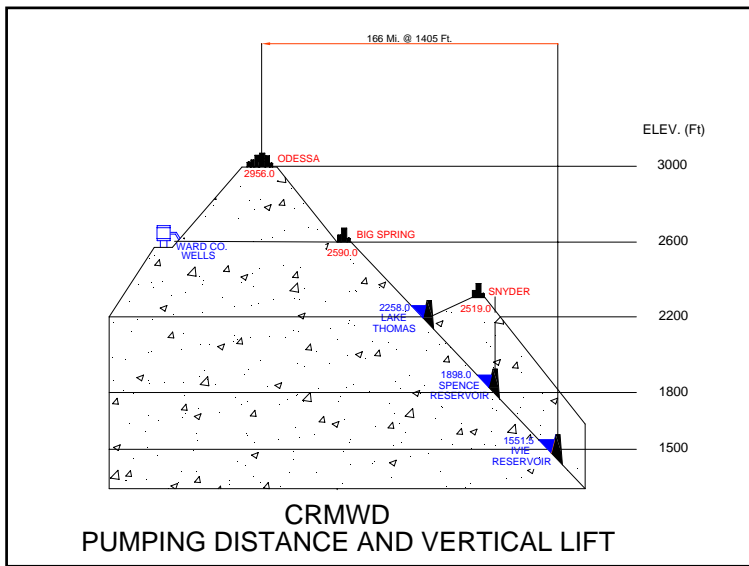
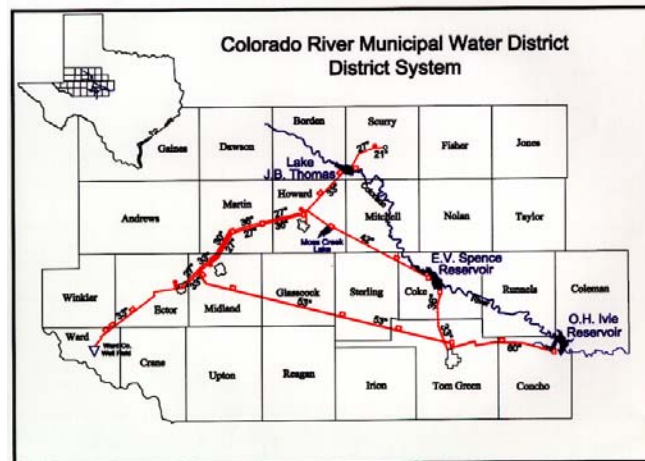

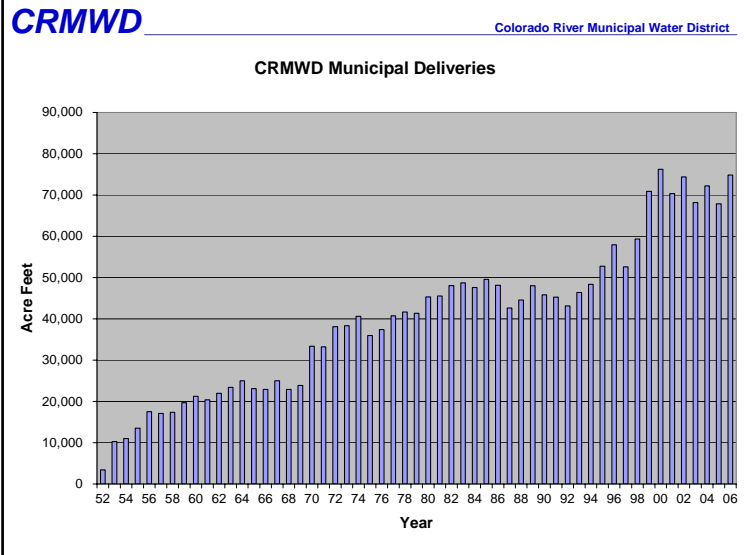

Potential Water Sources

- Lakes – *Subject to Drought,*
- *No Available Future Sites.*
- Groundwater – *Little Recharge*
- *Long Distance from need.*
- Conservation
- **Reuse**
- Desalination of brackish water

CRMWD 

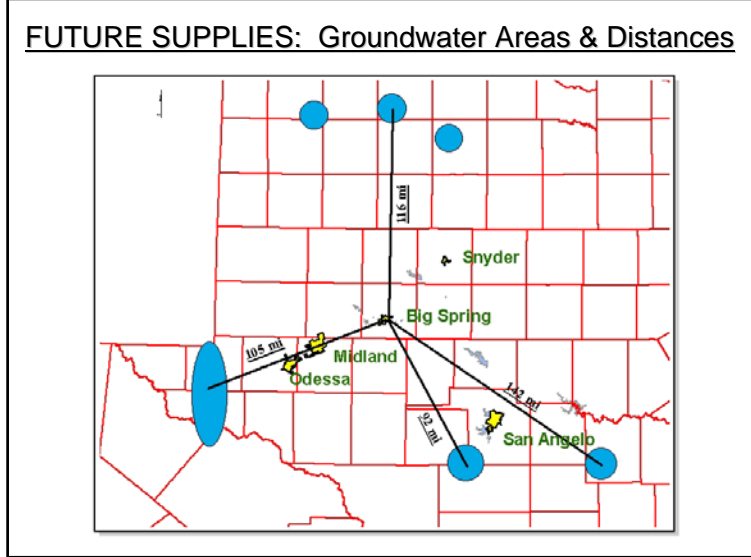
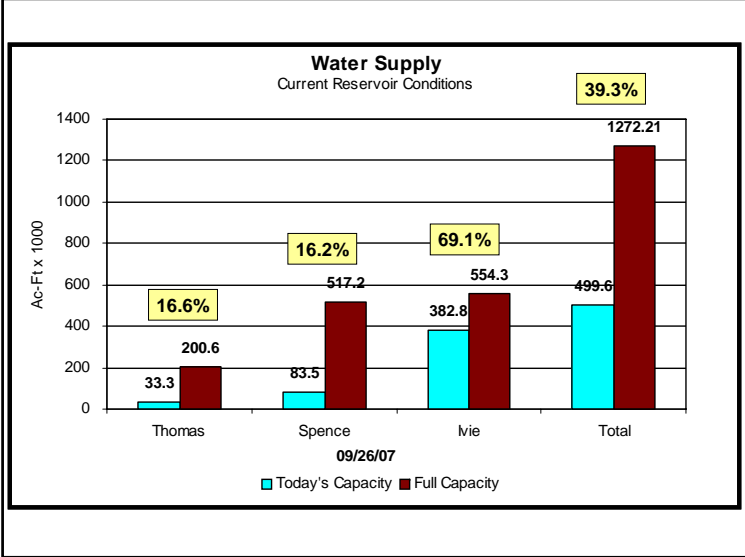

Public Meeting – Preliminary Design Report

1. Welcome & Project Overview
John Grant – General Manager CRMWD
2. Water Demands & Projections
Chris Wingert – CRMWD
3. **Project Discussion**
David Sloan – F&N
4. Closing Comments & Questions
John Grant – General Manager CRMWD

The Water Cycle



CRMWD



The Natural Water Cycle

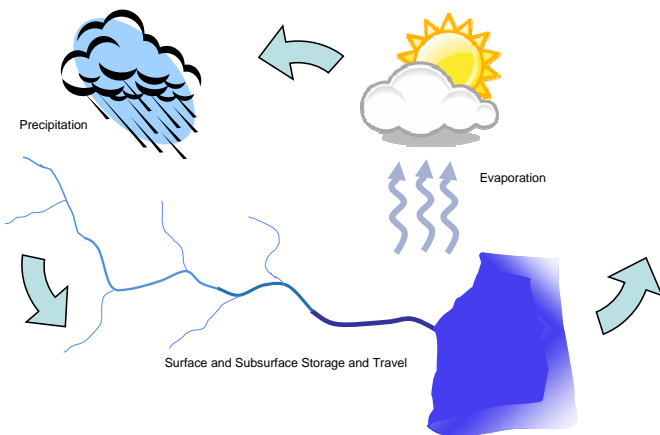

CRMWD

Colorado River Municipal Water District

The "Other" Water Cycle



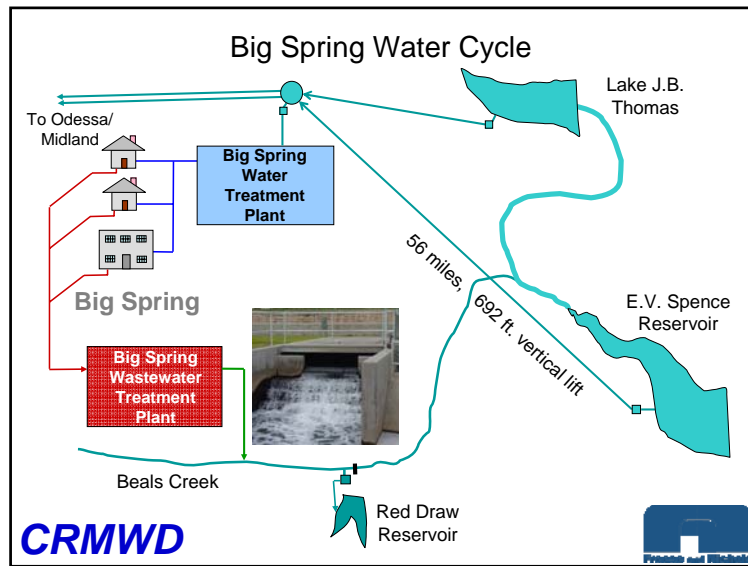
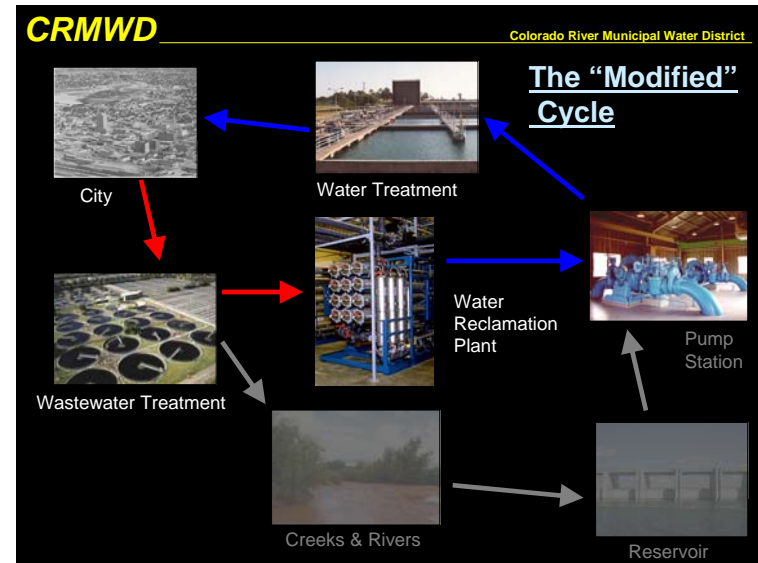
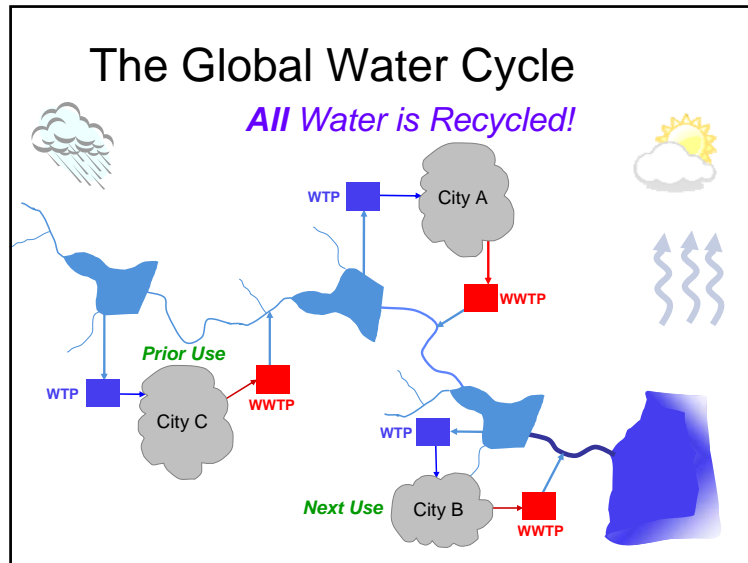

Reclamation (or Reuse)

What is it?

CRMWD

Water Reclamation



- AKA: Water recycling, water reuse
- Treating wastewater (sewage) to a usable quality and making appropriate use of it
- Quality required depends upon type of use

CRMWD



Types of Water Reclamation

- Landscape Irrigation – Golf Courses, Parks, Campuses, etc.
- Power Plant Cooling Water
- Construction Dust Control
- Industrial Process Water
- Agricultural Irrigation
- Water Supply Augmentation



Direct Non-potable Reuse

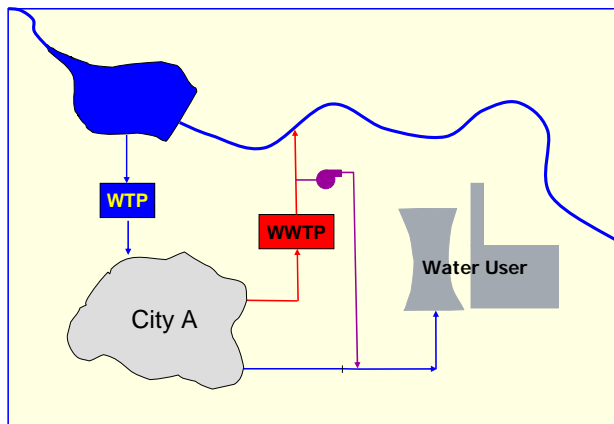

Why Water Reclamation?

- Readily available source
- Already pumped to the cities – other sources are far away
- Drought-proof supply
- As cities grow, supply increases
- Better quality after treatment than raw lake water
- Use 100% of the water 100% of the time

CRMWD



Is Reclamation Safe?



CRMWD



What's different about wastewater?

- Pathogens (organisms)
 - Bacteria
 - Protozoans (*Giardia*, *Cryptosporidia*)
 - Viruses
- Microconstituents
 - Pharmaceuticals, Endocrine Disruptors
 - Pesticides, Herbicides
 - Industrial chemicals
- Dissolved Solids (Salts, Hardness)

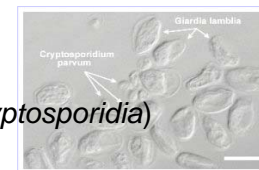

Multiple Barrier Approach



- Fundamental concept in public water supply
- Provide repeated opportunities to remove contaminants
- Don't put all eggs in one basket



CRMWD



Who else is doing reclamation for Water Supply Augmentation?

- **EI Paso***
- Tarrant Regional Water District
- North Texas Municipal Water District
- Cloudcroft, NM
- **Orange County (CA) Water District***
- **Many other unacknowledged cases**

**Already operating long-term*

CRMWD



El Paso Fred Hervey Project Indirect Potable Reuse - Groundwater

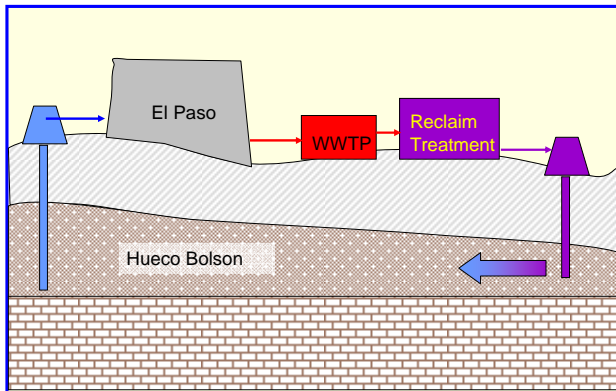

Tarrant Regional Water District

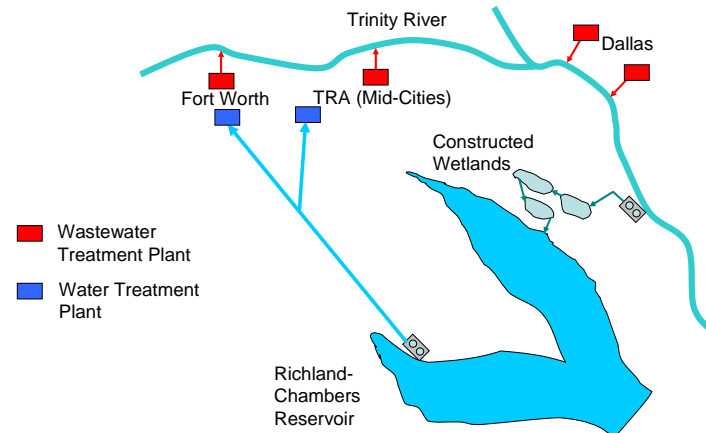

Orange County Water District

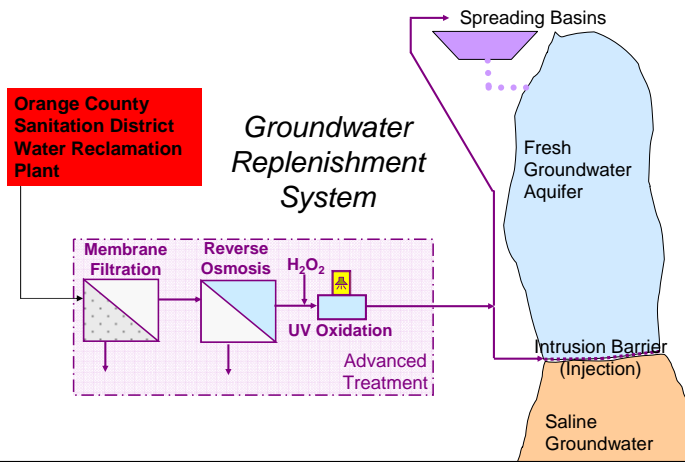

Cloudcroft, New Mexico

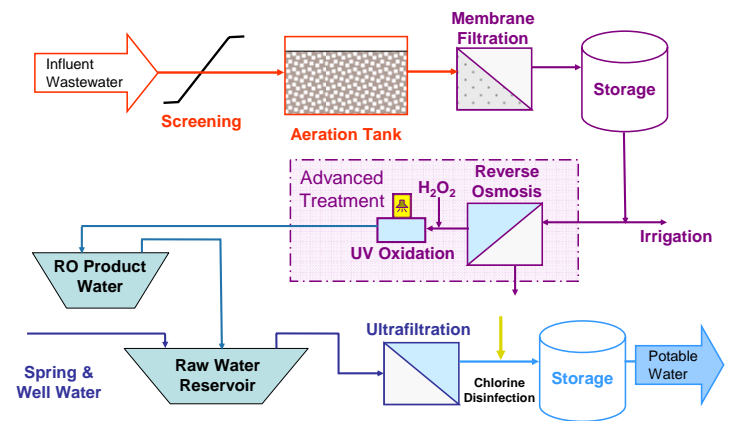

Proposed Treatment Processes

- Membrane Treatment/Filtration
- Reverse Osmosis (RO)
- Ultraviolet Disinfection & Oxidation

CRMWD



Membrane Filtration Range

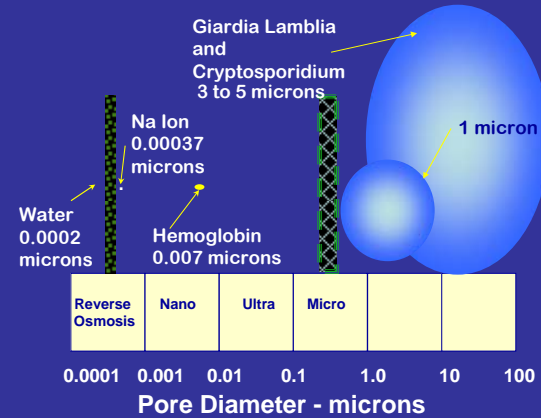

Relative Sizes of Small Particles

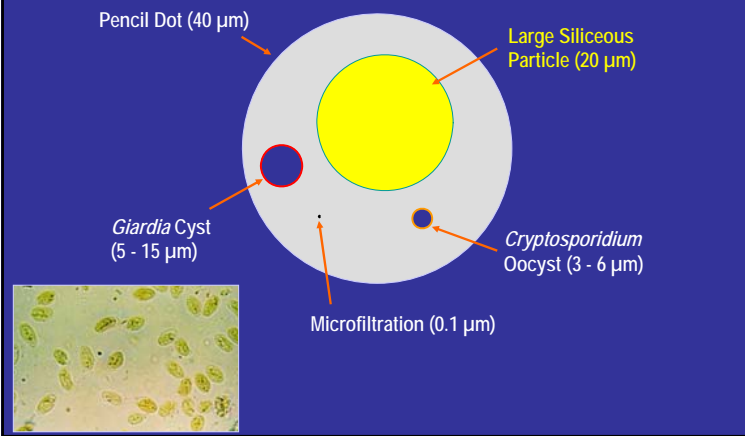

Membrane Filtration (Microfiltration)



Desalination

- Removal of dissolved salts from water
 - Chloride
 - Sulfate
 - Hardness
- AKA: Desalting, Desalinization, Demineralization, Desal, Demin
- Preferred method: Reverse Osmosis (RO)

CRMWD



Reverse Osmosis (RO)

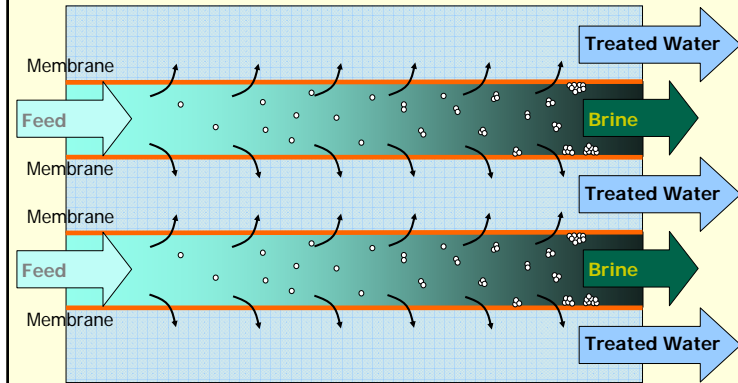

CRMWD



Reverse Osmosis



Reverse Osmosis

- Efficient removal of chlorides and other minerals
- Effective barrier to pathogens, including viruses
- Removes many organic contaminants, including certain pharmaceuticals, endocrine disruptors, pesticides, etc.
- Typical process used for producing bottled water

CRMWD



Ultraviolet Disinfection/ Advanced Oxidation

- Sterilizes water
- Provides different type barrier from other processes
- Breaks down chemicals which pass through membranes



CRMWD

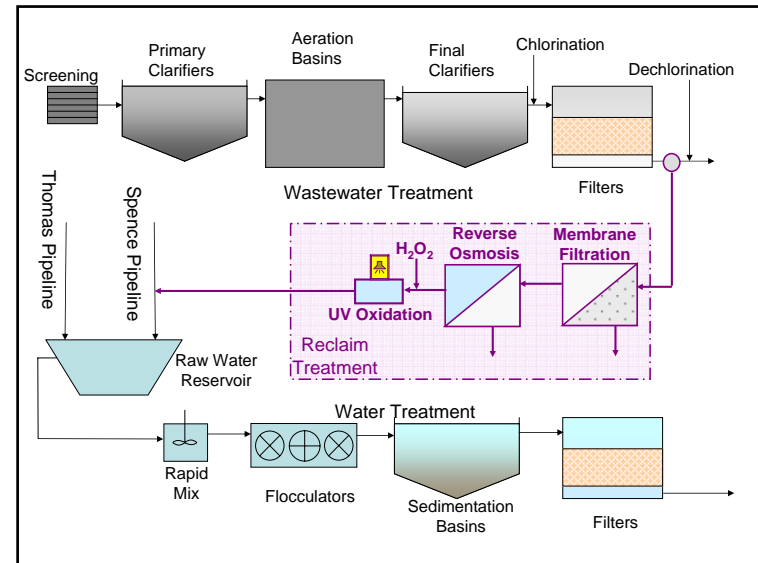

Contaminants vs. Barriers

Contaminant	Membrane Filtration	Reverse Osmosis	Ultraviolet Oxidation
Bacteria	Partial	Excellent	Excellent
Viruses	Partial	Excellent	Excellent
Protozoans	Excellent	Excellent	Excellent
Pharmaceut., Endocr. Disr.	No effect	Good	Good
Pesticides	No effect	Good	Good
Salts	No effect	Good	No effect

CRMWD



Proposed Big Spring Project



CRMWD



Proposed Big Spring Reclamation Facilities



How Much Water?

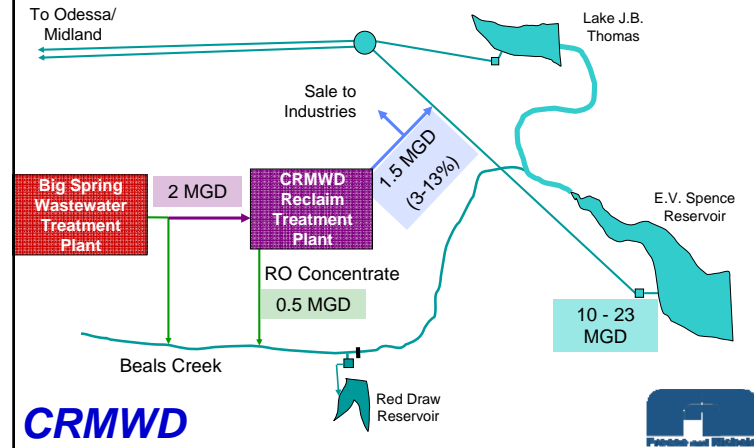

Proposed Big Spring Reclamation Treatment Facilities

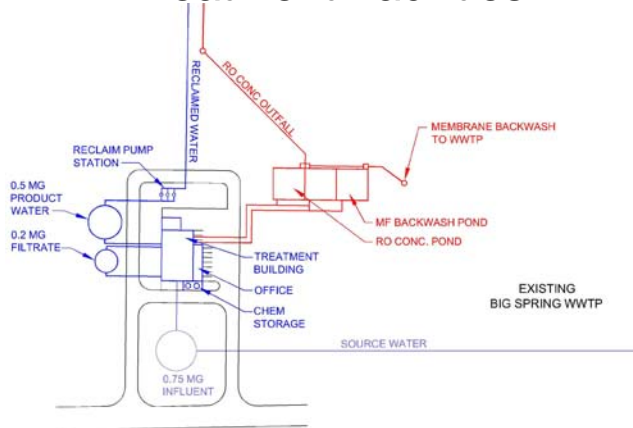

Projected Power Demands and Evaluation of Alternate Energy Sources



CRMWD



Projected Energy Requirements



- Disadvantage: High Power Requirements

Total Power Consumption:	2.24 million KWH/year
Total Power Costs: (Assuming \$0.07/KWH)	\$ 157,000 /year

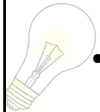

- Alternative: Other Energy Sources

CRMWD



What is Alternate Energy ?

- Energy derived from natural resources



- That does not harm the environment
- That does not deplete Earth's natural resources

CRMWD



Why use Alternate Energy ?

- Constantly replenished by nature



- Cleaner source of energy

- More stable energy supply for the future
- Offset electricity costs



CRMWD



Alternate Energy Sources

Potential Sources at City of Big Spring:

1. Methane from Waste
2. Solar Energy
3. Wind Power



CRMWD



Alternate Energy #1: Methane from Waste



CRMWD



How is Power Created from Landfill Waste?

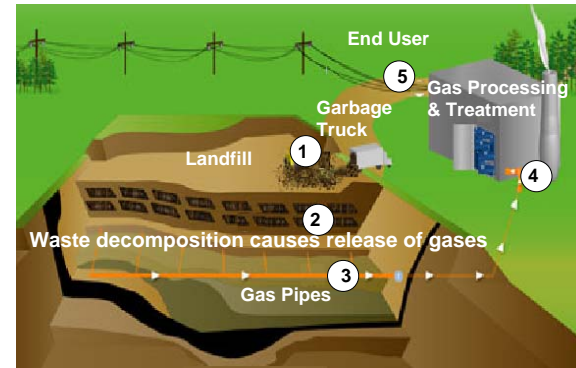

CRMWD



Potential Sources at Big Spring

- Municipal Solid waste Landfill
 - Requires installation of collection system (\$1M. - \$2M.)
 - Arid conditions leads to modest production of methane
 - Questionable economic feasibility
- Wastewater Treatment Plant
 - Digester gas contains 60% methane
 - A methane gas recovery system processes waste to energy
 - Significant reduction in WWTP's emissions
 - Further analysis required to evaluate economic feasibility

CRMWD



Alternate Energy #2: Solar Energy



CRMWD



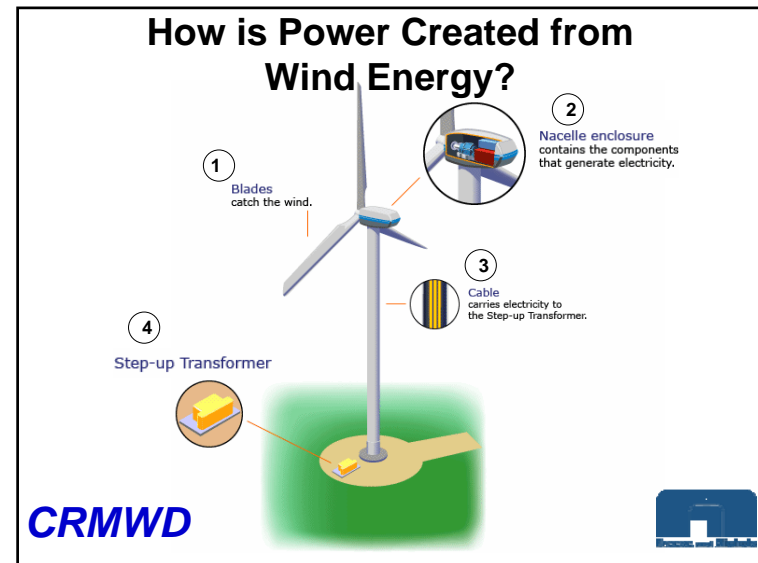
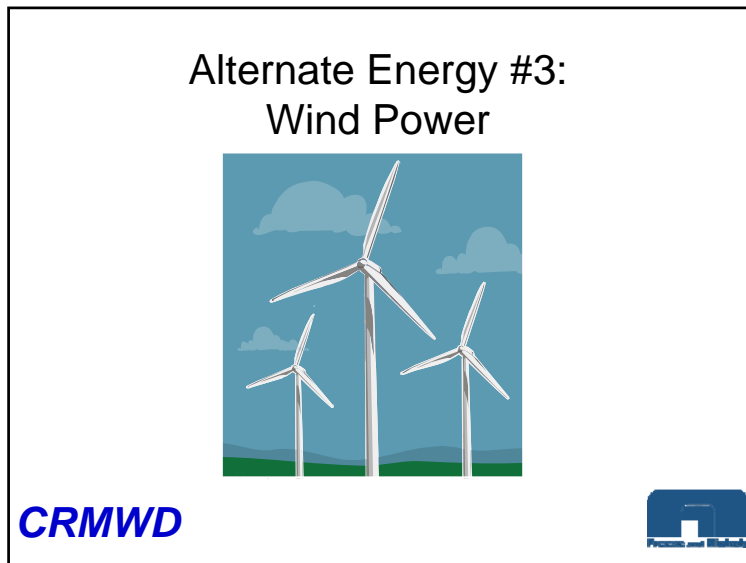
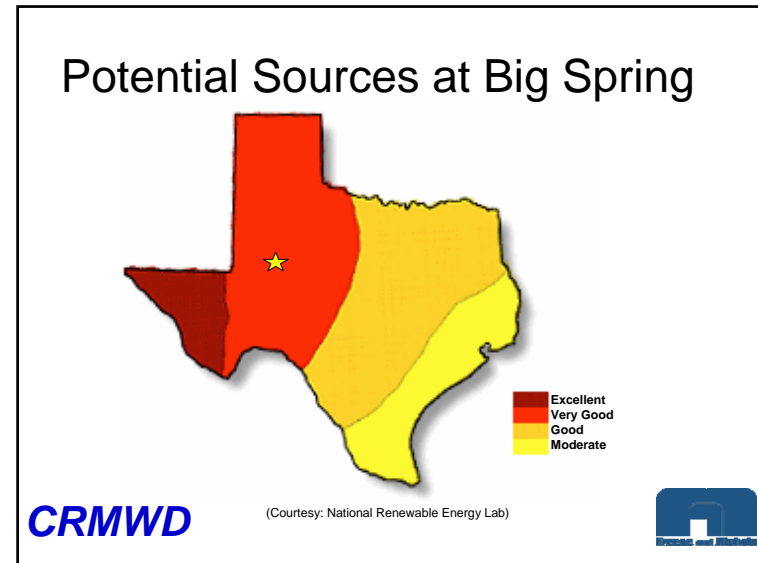
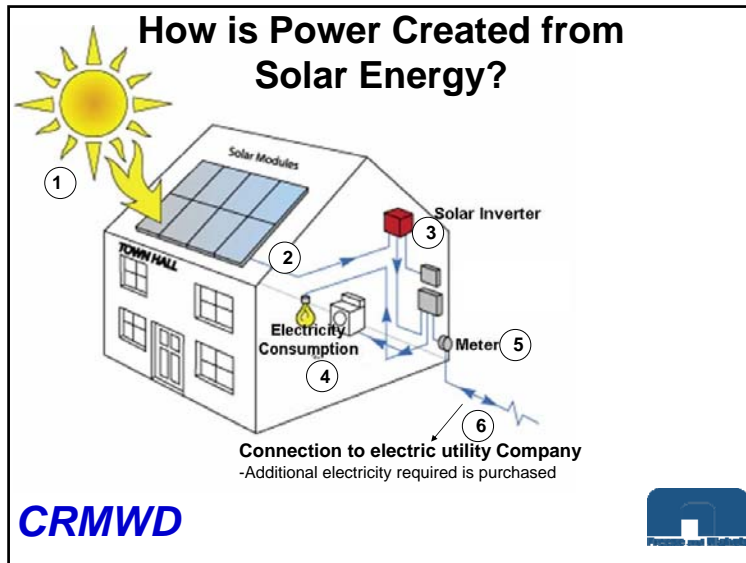

Potential Sources at Big Spring

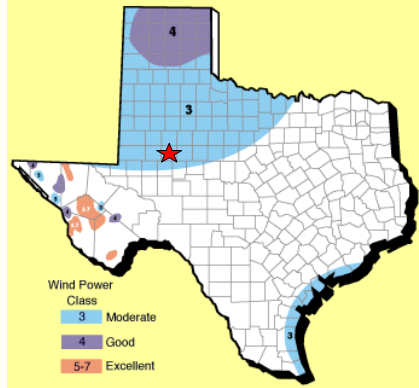

(Courtesy: Texas Environmental Center)

CRMWD



Summary

450,000 KW-hr/year power production using :		
Total Investment	\$ 1,270,000	\$ 375,000
Annual Savings (Assuming \$0.07/KWH)	\$ 31,500	\$ 31,500
20 yr-Debt Service @ 5%	\$ 101,908	\$ 30,091

CRMWD



How Much Does it Cost?

•Capital Cost: \$9.47 M

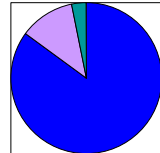
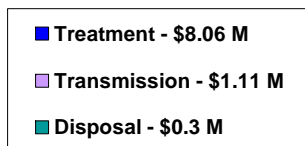

- Operating Cost: \$0.67 M per year
- Overall Unit Cost: **\$2.59/1000 gal.**

CRMWD



TWDB Funding Assistance

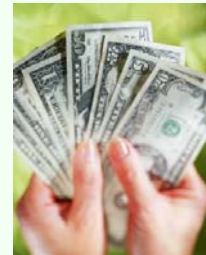

Regional Planning Grant

\$ 150,000 State Participation in Planning Effort

CRMWD



Next Steps

- Pilot Testing
- Permitting
- Final Design



CRMWD



Public Meeting – Preliminary Design Report

1. Welcome & Project Overview
John Grant – General Manager CRMWD
2. Water Demands & Projections
Chris Wingert – CRMWD
3. Project Discussion
David Sloan – F&N
- 4. Closing Comments & Questions**
John Grant – General Manager CRMWD

What if I have Questions?

- Reclamation website:
WWW.CRMWD.org
Go to Reclamation
– Website provides updated information and channel for questions and comments
- Contact Chris Wingert, P.E., CRMWD Manager of Planning & Development,
432-267-6341
- E-mail Chris: cwingert@CRMWD.org

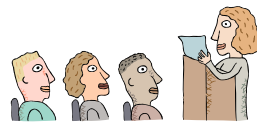

CRMWD



WATER FOR OUR FUTURE

A Feasible Plan...

The Colorado River Municipal Water District (CRMWD) and the Region F Regional Water Planning Group have studied many options for increasing and improving area water supplies. A feasibility study conducted in 2005 for CRMWD by the engineering firm of Freese and Nichols has found that reclaiming water is a practical way to improve water quality and augment our supply. It makes sense for all of us in the Permian Basin to consider water reclamation as part of the CRMWD's water supply strategy.

We are not alone in seeking to augment our water supplies. El Paso boasts one of the most advanced systems in Texas, with four reclamation plants. Wichita Falls, North Texas Municipal Water District and Orange County, California are also exploring water reclamation as a means to pad their water supplies.

Essentially, water reclamation accelerates the natural processes of filtration, exposure to air and light, and dilution. With a water reclamation system, treated water that we now discharge to flow away to other places becomes a resource that, through acceleration, can be purified for our use, meeting the standards for drinking water established by the Texas Commission for Environmental Quality (TCEQ) and the U.S. Environmental Protection Agency (EPA).

THE BIG SPRING PROJECT

Moving Forward...

The 2005 Regional Water Reclamation Project Feasibility Study to determine technical and economic feasibility of capturing unused wastewater determined that Big Spring, Texas was the most suitable location for the new treatment facilities.

The proposed treatment facility will be the home of the additional treatment sequence required to filter and clean the water before it can be considered equal to existing raw water supplies and safe for human consumption. For the Big Spring Reclamation Project, a sequence consisting of membrane filtration, reverse osmosis and ultraviolet oxidation is proposed (as seen inside this brochure).

The reverse osmosis, ultraviolet oxidation, and membrane filtration steps will remove pesticides and salts from the water. This triple treatment builds redundancy into the system, giving it an extra measure of safety. After the process is completed, the end result will be up to the standards of bottled water and will contain fewer minerals, making the water quality much improved.

The mission of the Colorado River Municipal Water District is to maintain an adequate supply of the best quality water possible, at a reasonable cost, for its service area in West Texas

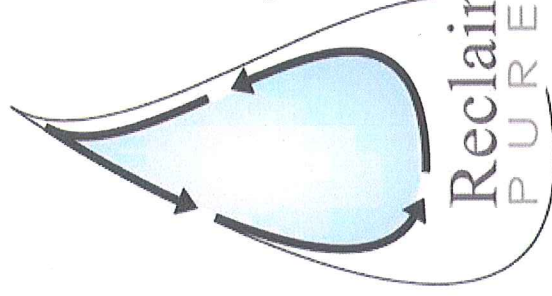

The Science of
Reclaimed Water

LEARN MORE AT:
www.CRMWD.org

CRMWD
Colorado River Municipal Water District

Water for
Our Future: **5 Steps to Reclaimed Water**

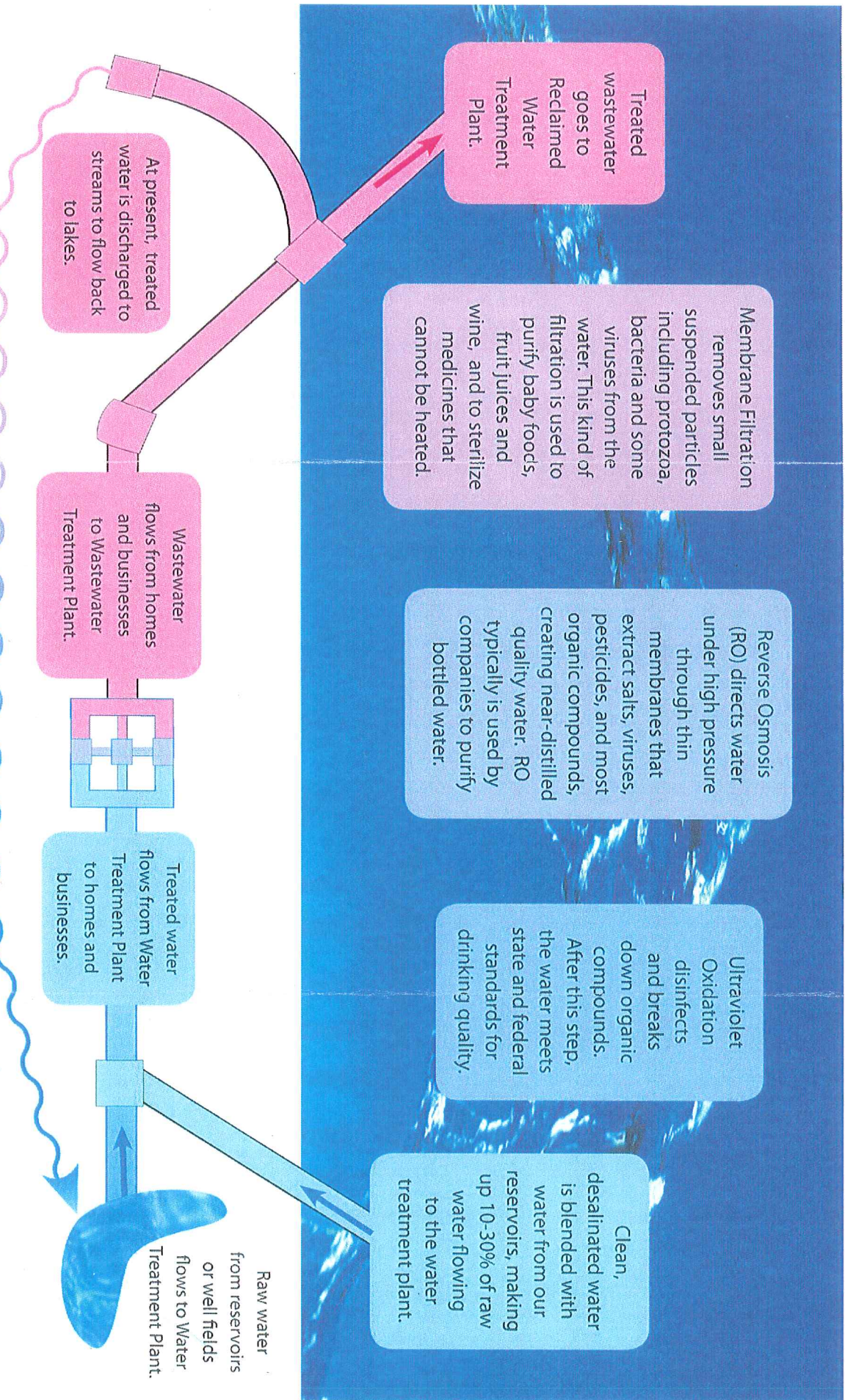

For More Information, Contact:

Chris L. Wingert, P.E., Manager of Planning & Development
 Colorado River Municipal Water District
 P.O. Box 869 Big Spring, Texas 79721-0869
 cwingert@crmwd.org 432-267-6341 Fax: 432-267-3121
 www.crmwd.org

