

TurnerCollie&Braden Inc.

**A REGIONAL WASTEWATER
FACILITY PLAN FOR THE
CLEAR LAKE AREA**

FINAL REPORT

**A STUDY PARTIALLY FUNDED THROUGH
A TEXAS WATER DEVELOPMENT BOARD GRANT**

Job No. 11-00245-001

Min Chu

Min Chu, P.E.
Project Manager

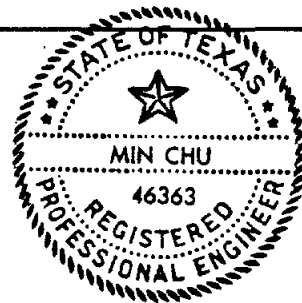

Neil E. Bishop

Neil E. Bishop, P.E., PhD.
Senior Vice President

January 1991

ENGINEERS • PLANNERS

TEXAS AUSTIN / DALLAS / FORT WORTH / HOUSTON COLORADO DENVER

TABLE OF CONTENTS

1

	Title	Page
TEXT		
SECTION I	INTRODUCTION	I-1
	Background	I-1
	Study Objectives	I-1
	Study Area	I-2
	Wastewater Management Agencies	I-2
	Public Involvement	I-3
SECTION II	WASTEWATER FLOW PROJECTIONS	II-1
	Population and Land Use Projections	II-2
	Wastewater Unit Flow Rates	II-5
	Wastewater Flow Projections	II-7
SECTION III	EXISTING WASTEWATER FACILITIES	III-1
	Clear Lake City Water Authority	III-1
	Harris County WCID No. 75	III-2
	Harris County WCID No. 50	III-2
	City of Seabrook	III-3
	City of Pasadena	III-3
	Lexel Establishment	III-4
	L.H. Homan	III-4
	Gulf Coast Waste Disposal Authority	III-4
	Other Industrial Wastewater Facilities	III-5
SECTION IV	REGIONAL WASTEWATER SYSTEM ALTERNATIVES	IV-1
	Requirements for Regional Facilities	IV-1
	Regional Alternative 1	IV-3
	Regional Alternative 2	IV-8
	Regional Alternative 3	IV-10
	Probable Project Costs	IV-11
	Evaluation of Regional Alternatives	IV-11
SECTION V	FINANCING OPTIONS	V-1
	Federal Programs	V-1
	State Programs	V-2
	Funding Requirements	V-4

	Title	
SECTION VI	Conclusions and Recommendations	VI-1
APPENDIX I	Water Conservation and Drought Contingency Plan	
APPENDIX II	Public Comments	
 TABLES		
Table II-1	Existing and Projected Population through Year 2010 Breakdown by Serial Zone	
Table II-2	Existing and Projected Population through Year 2010 Breakdown by City	
Table II-3	Projected Wastewater Flows through Year 2010 Breakdown by Serial Zone	
Table II-4	Projected Wastewater Flows through Year 2010 Breakdown by City	
Table III-1	Texas Water Commission Wastewater Discharge Permits	
Table III-2	TWC Effluent Limits of GCWDA Bayport Facility	
Table IV-1	Texas Water Commission Water Quality Standards for Segments in the Clear Lake Study Area	
Table IV-2	Projected Ultimate Development Flows to Clear Lake Forest Pump Station	
Table IV-3	Regional Alternative 1 - Probable Cost Analysis	
Table IV-4	Regional Alternative 2 - Probable Cost Analysis	
Table IV-5	Regional Alternative 3 - Probable Cost Analysis	
Table IV-6	Operation and Maintenance Costs of Proposed Improvements	

Tables are grouped and presented at the end of each section.

EXHIBITS

- Exhibit 1 Study Area Map
- Exhibit 2 Existing Land Use Map
- Exhibit 3 Locations of Industries in Bayport Industrial District
- Exhibit 4 Census Tract and Serial Zone Boundary Map
- Exhibit 5 Locations of TWC Wastewater Discharge Permits
- Exhibit 6 CLCWA Wastewater Treatment Plant Flow Diagram
- Exhibit 7 Existing Sanitary Sewer Systems
- Exhibit 8 Harris County WCID 75 Wastewater Treatment Plant Flow Diagram
- Exhibit 9 Harris County WCID 50 Wastewater Treatment Plant Flow Diagram
- Exhibit 10 City of Seabrook Wastewater Treatment Plant Flow Diagram
- Exhibit 11 Lexcel Establishment Wastewater Treatment Plant Flow Diagram
- Exhibit 12 L.H. Homan (Lake Estates) Wastewater Treatment Plant Flow Diagram
- Exhibit 13 GCWDA Bayport Wastewater Treatment Plant Flow Diagram
- Exhibit 14 M.A. Hanna Wastewater Treatment Plant Flow Diagram
- Exhibit 15 Regional Alternative 1
- Exhibit 16 Regional Alternative 2
- Exhibit 17 Regional Alternative 3

Exhibits are grouped and presented at the end of the report before Appendix I.

BACKGROUND

The Clear Lake City Area, located in southeast Harris County, Texas has experienced substantial urban growth during the last few years. These residential, commercial, and industrial developments have generated needs for additional wastewater collection and treatment capacities. Many of these current and planned developments are comprised of relatively small residential or commercial projects. The continued needs for wastewater facilities to serve the individual subdivisions or commercial tracts could potentially result in a proliferation of small wastewater treatment plants (WTPs) in the area.

Based on Texas Water Commission (TWC) records, small WTPs historically have produced a lower quality effluent which, in some cases, has resulted in undesirable and serious water pollution problems. It has also been determined that small WTPs are usually less cost effective than the larger regional wastewater plants, resulting in higher consumer costs. These considerations have prompted local concerns about the impact of effluent from small WTPs on water quality of several ecologically sensitive estuaries and Galveston Bay. Attention has also been focused on the long-term cost efficiency of existing and future WTPs. In light of this concern, the Gulf Coast Waste Disposal Authority (GCWDA), in cooperation with the cities of Taylor Lake Village and El Lago and the Clear Lake City Water Authority (CLCWA), applied for and obtained a planning grant from the Texas Water Development Board (TWDB) in April 1990 to partially fund a regional wastewater study to develop and evaluate feasible solutions to the short- and long-term wastewater facility needs.

STUDY OBJECTIVES

The purpose of this study is to investigate the feasibility for developing and implementing a regional wastewater plan for the Clear Lake study area so that future wastewater facilities can be planned, designed, and constructed in a manner consistent with sound environmental, economic, technical, and regulatory considerations.

The primary objective of this project is to develop and select a regional wastewater plan that is environmentally acceptable; meets applicable local, state, and federal criteria

and regulations; provides for cost-effective sizes; is financially and politically implementable; and meets the short- and long-term development needs of the study area.

STUDY AREA

The study area as shown in Exhibit 1 is located approximately 25 miles southeast of downtown Houston and includes the cities of Shoreacres, Seabrook, El Lago, and Taylor Lake Village. A portion of the study area is also located within the corporate limit and extraterritorial jurisdiction (ETJ) of Pasadena. The planning area encompasses approximately 21,000 acres, or 33 square miles, and is bounded on the west by the City of Houston corporate limit, on the north by the City of La Porte corporate limit, on the east by Galveston Bay, and on the south by Clear Lake.

The study area has the typically flat topography of the Gulf Coastal Plain. Ground surface elevation in the area ranges from about 15 feet to 0 feet above mean sea level with a typical slope of about one foot per mile. Because of the flat topography, it has been necessary to design the wastewater collection systems on minimum grades and to provide sewage lift stations in the systems at locations where the economical depth limit is exceeded for installation of sewer pipe.

WASTEWATER MANAGEMENT AGENCIES

The planning area includes five cities, three municipal utility districts, and two regional authorities. All these entities have the authority to provide wastewater services. The five cities are Shoreacres, Seabrook, El Lago, Taylor Lake Village, and Pasadena. The three municipal utility districts are Harris County Water Control & Improvement District (HCWCID) 50, HCWCID 75, and Harris County Municipal Utility District (HCMUD) 181. The two regional authorities are GCWDA and CLCWA.

The five cities in the study area have extensive powers to engage in activities necessary for the protection of the health, safety, and welfare of its residents, including the planning, design, construction, and operation of wastewater collection and treatment facilities. The three water districts were created under state law and authorized as taxing entities by the Texas Constitution. They may levy ad valorem taxes and issue bonds to pay

for water and sewer facilities. They also have the authority to construct, maintain, and operate wastewater facilities.

GCWDA was created by an Act of the 61st State Legislature in 1969 as a regional water pollution abatement authority primarily operating in Chambers, Harris, and Galveston counties. One of the Authority's missions is to "advance the established policy of the state to maintain the quality of the waters in the state consistent with the public health and public enjoyment thereof, the propagation and protection of terrestrial and aquatic life, the operation of existing industries, and the economic development of the state." GCWDA was further given the charge to develop and update comprehensive water quality management and waste disposal control plans. GCWDA may acquire, construct, and operate waste treatment systems for both municipal and industrial users, and it has inspection, monitoring, and enforcement authority. GCWDA also has statutory authority relative to stream standard setting, regulation of solid waste disposal, air quality, and septic tank disposal. In addition, GCWDA has broad powers related to the financing of wastewater treatment facilities. It has ad valorem taxing power of up to 10 cents per \$100 valuation if such taxing is approved by voters in the region. GCWDA also has the authority to issue either general revenue bonds secured by ad valorem taxes or revenue bonds to raise the capital for facility construction. To date, the revenue bonds have been the major financial resources utilized.

CLCWA was created in May 1963 by H.B. 1003, Regular Session, 58th Legislature of Texas. The Authority constructs, operates, and maintains facilities for supplying water service, sanitary sewer service, and stormwater drainage for customers in its area. In addition, the Authority provides service to a limited number of customers outside its boundaries on a contractual basis.

PUBLIC INVOLVEMENT

Public input was actively solicited during the course of this study. A project kick-off meeting was held in May 1990 to discuss the purpose, scope, and schedule of the project. A public meeting was subsequently held in July 1990 to discuss the regional alternatives. An additional public meeting was held on November 5, 1990 to discuss the results of the

planning effort and to solicit public comments on the draft report. This final report has incorporated comments received through the public review process, including comments made by the Texas Water Development Board and the Texas Water Commission.

The first step in developing a regional wastewater facility plan for the study area is to estimate how much wastewater will be generated during the planning years. One of the most important factors affecting the magnitude of wastewater flow is people. Domestic sewage is produced by people who live and work in the area. If in addition to office, institutional, and other commercial developments, people also work in factories or industries, process wastewater may be generated from these locations. The amount of process wastewater can vary significantly from industry to industry, depending greatly on the amount of water used for particular products or services.

Population projections, when combined with unit wastewater flow rates, give an estimate of how much wastewater will be generated as the area continues to grow. On the other hand, land-use projections, which indicate where people may live or work in the future, help determine the geographical allocations of wastewater loadings. Both types of data are needed to more accurately plan for the future wastewater collection and treatment facility needs.

In addition to being affected by how many and where people live and work in the study area, the amount of wastewater flows also may be impacted by the life style and water conservation effort of area residents. As an example, single-family housing residents tend to contribute more wastewater per dwelling unit than multifamily housing residents because of the larger number of people living in a household and more usage of washing machines. Water conservation practices can result in substantial reduction in water demands. However, their impact on wastewater flows may be less since some of the conservation measures affect only the nonreturnable portion (i.e., not returned to the sewer system as sewage) of water uses. This portion of water uses includes the water for consumption, irrigation, car washing, and cooling purposes, as well as losses through leaks in the water distribution system. In general, should the installation of various water conservation kits become a mandatory requirement in the future, approximately 5 to 10 percent reduction in wastewater flows may be realized. The impact of these water conservation practices on future wastewater needs has been considered in this study.

The scope of work for this project calls for projections of wastewater flows for the years 2000 and 2010. The following paragraphs provide discussions on existing and

projected population, employment and land-use information, as well as estimates of projected wastewater flows for the two milestone years.

POPULATION AND LAND-USE PROJECTIONS

An existing land-use map of the study area is shown in Exhibit 2. As illustrated in this exhibit, the northern half of the study area is primarily industrial in nature and includes an oil field and a major portion of the 10,500-acre Bayport Industrial District. This industrial district is currently occupied by more than 50 industries with approximately 5,700 employees. The boundary of the district and locations of these industries are shown in Exhibit 3. Also included in this portion of the study area are a small section of Armand Bayou Park and Nature Center and two relatively small residential communities located near Bayport Channel in the cities of Shoreacres and Pasadena.

The southern half of the study area consists primarily of residential land uses and the major portion of Armand Bayou Park and Nature Center. Single-family and multifamily residential developments predominate in the cities of Taylor Lake Village, El Lago, and Seabrook, as well as in the Brookwood subdivision located on the far western portion of the study area. Some commercial developments exist along major thoroughfares while the University of Houston's Clear Lake City campus is the major institution in the area. Immediately south of the campus but outside the study area is the Johnson Space Center, which has more than 80 companies providing related support business. The space program has a current work force of almost 15,000, and more growth is projected.

According to the 1980 census map, eight census tracts are located wholly or partially within the study area. These eight census tracts are 36601, 36602, 36700, 36801, 36802, 36900, 37000, and 37303. Because of substantial changes in demographic characteristics during the last decade in two of the eight tracts, the two tracts were subdivided into additional census tracts in the 1990 census. Tract 36601 has been replaced by four census tracts (i.e., 36611, 36621, 36631, and 36641) while tract 37000 was replaced by tracts 37010 and 37020.

For transportation planning purposes, the Houston-Galveston Area Council (HGAC), in the past, has divided the 1980 census tracts within its planning area into

subtract levels and defined each subtract as a serial zone. As part of the Houston-Galveston Regional Transportation Study (HGRTS), HGAC planners used aerial photographs and other land-use data to allocate pertinent demographic information within a particular census tract to various serial zones. Serial-zone designation is established by adding a decimal point and two digits after the census-tract number. Based on the map provided by HGAC, 28 serial zones are located within the study area. Out of the 28 serial zones, 19 are totally within the study area while the remaining nine are only partially within it. Boundaries of the 1980 census tracts and their corresponding serial zones within the study area are shown on Exhibit 4.

Using the 1980 and preliminary 1990 census information, the 1980 and 1990 population estimates for the 28 serial zones were derived and are summarized in Table II-1. Similar data for the cities of Seabrook, Shoreacres, El Lago, and Taylor Lake Village are listed in Table II-2. It should be noted that although preliminary 1990 population estimates are available from the Census Bureau at city and county levels, only housing-unit counts are provided at the census-tract level. In order to convert the housing units into population estimates at the census-tract and serial-zone levels, ratios of people to housing units from the 1980 census were used. Harris County, the City of Houston, and many other municipalities in the region are currently evaluating the preliminary 1990 census data. Some of these entities have decided to protest the Census Bureau's findings. These preliminary census data, however, do represent the most recent estimates of population currently available with reasonable accuracy. For this reason, they have been incorporated into this study.

As shown in Table II-1, total population within the study area has grown from 15,465 in 1980 to 19,588 in 1990 at a compounded annual growth rate of 2.4 percent. Some serial zones have shown minimal growth while others have shown substantial increases. Eleven serial zones are either undeveloped or zoned for industrial uses with no residential population. Ten serial zones have annual growth rates of 2.0 or less while five other zones were growing at 5 percent and more. At the city level, only Seabrook was growing during the last decade. The other three cities show either minimal growth or even declining population. The study area is expected to continue to grow through year 2010. There are

several population projections currently available. The primary sources of population projections used in this study are those prepared by the TWDB and HGAC. As part of Texas Water Plan effort, the TWDB has prepared population projections at county and city levels. The high and low series of TWDB projections for each of the four cities located in the study area through the year 2010 are summarized in Table II-2. HGAC has developed population projections at serial-zone levels through the year 2010. Since some of these projections were prepared using an econometric model developed in the early 1980s, they may not accurately reflect the wide fluctuation of economic activities which occurred in the Clear Lake Area. Major employment centers such as Johnson Space Center, Bayport Industrial District, and the University of Houston-Clear Lake along with excellent recreational amenities such as Clear Lake and Armand Bayou Park and Nature Center, have attracted a large population to move into this region. However, during the depression in the oil industry between 1982 and 1986, the growth rate slowed somewhat. With a rebound in the petrochemical industries and the continued growth in the space program, the Clear Lake City region has again experienced an accelerated growth rate in the last several years. For this reason, some adjustments to the HGAC and TWDB projections were made before they were adopted for use in this study. It should be noted, however, that much of the fast growth in recent years apparently occurred in many master-planned subdivisions located outside the study area. Only the Brookwood subdivision located in the far western portion of the study area showed a high growth rate.

The adjusted 2000 and 2010 projections for the 28 serial zones and four cities are summarized in Tables II-1 and II-2, respectively. Overall, the study area is projected to grow from a population of 19,588 in 1990 to 25,506 in 2000 and 29,304 in 2010. The compounded annual growth rate for the entire study area for the first ten years (1990 to 2000) has been projected to be 2.7 percent, slightly higher than the 2.4 percent which occurred between 1980 and 1990. This growth rate is projected to slow to 1.4 percent per year between the years 2000 and 2010. The Brookwood subdivision in serial zone 37000.15 is projected to have the highest growth rate in the study area between 1990 and 2000. The 900-lot subdivision developed by the Friendswood Development Company is expected to be fully built out within the next few years. The former Lunar Institute tract located in serial

zone 37303.05 and owned by Rice University also has a great potential to be developed into multifamily and commercial land uses within the next decade because of its prime location. In addition, serial zones 36700.01, 36700.04, 36700.05, 36802.01, and 36802.02 in the City of Seabrook are also projected to maintain healthy growth rates during the planning period.

WASTEWATER UNIT FLOW RATES

Wastewater flows typically consist of return flows from residential, commercial, institutional, and industrial water uses and infiltration and inflow (I/I) from groundwater and stormwater sources. The wastewater return flows usually represent approximately 80 to 95 percent of the winter months water use. The effects of water consumption through lawn watering, irrigation, and car washing are minimal during the colder months. The I/I component of the wastewater flow, however, varies from system to system and greatly depends on the integrity of the collection system. Older systems tend to have more leaks and, therefore, result in higher I/I. New systems, if properly constructed, can expect minimal I/I.

Measured existing wastewater flows, when divided by populations served, can provide an estimate of unit flow rates in terms of gallons per capita per day (gpcd). When the unit wastewater flow rates are applied to projected population, future wastewater flows from a particular service area can be estimated. For long-range planning purposes, a typical unit flow rate of 100 gpcd has been a widely accepted number. This number does not account for any excessive wet-weather-related I/I and is usually used for planning a wastewater system serving primarily residential population with limited commercial, institutional, and light industrial developments. Since most existing systems have varying amount of wet-weather I/I, their unit flow rates can be quite different from the standard number of 100 gpcd. When a moderate amount of wet-weather I/I is included, a unit flow factor of 130 gpcd is considered reasonable.

A report entitled Greater Houston Area Water Quality Management Plan was published by HGAC in July 1990. In this report, HGAC compared the flows reported by individual wastewater treatment facilities in the 1989 Texas Water Commission Self Reporting System to existing populations served by these facilities. By dividing existing

flows by existing populations, HGAC estimated the gpcd factors for four of the domestic wastewater treatment plants located in the study area. The unit flow rates for these four facilities are listed below.

<u>Treatment Plant</u>	<u>GPCD</u>
Clear Lake City WA	146
City of Seabrook	151
HCWCID 75	130
HCWCID 50	90

In order to evaluate these unit flow factors, it is necessary to understand what these numbers mean. First, the self-reporting wastewater flows used to derive these factors are annual average flows which included portions of I/I entering into the sewerage system during wet periods. Sanitary sewer systems with excessive I/I problems would, therefore, have higher gpcd factors than those systems with minimal I/I. Second, since the wet-weather I/I is usually proportionate to the amount of rainfall received in a given service area, annual average flows of a wet year can be much higher than those of a dry year. Third, when two systems have similar populations, the sewerage system that receives commercial, institutional, and/or industrial wastewater flows in addition to sewage from residential areas would have a higher gpcd than the system serving only residential developments. The reason for the difference is that commercial, institutional, and industrial developments are not reflected in the population estimate. Fourth, the gpcd factor is sensitive to the accuracy of existing population estimates.

Since Harris County WCID 50 and Harris County WCID 75 systems serve primarily residential developments, their gpcd factors are lower than the Seabrook or Clear Lake City Water Authority system which serves varying commercial, institutional, and industrial customers in addition to the residential populations. According to the HGAC data, Harris County WCID 75 has a unit flow factor 44 percent higher than that of Harris County WCID 50. As will be discussed later in Section III of this report, HCWCID 75 has been experiencing excessive I/I in its collection system, which probably has contributed to its higher unit flow factor. WCID 75 is currently undertaking a sewer system rehabilitation

program to reduce the excessive I/I. When this program is completed, the system should have a lower gpcd factor.

Based on the analysis discussed above and considering the impact of implementing the water conservation program discussed in Appendix I, the following unit flow factors are adopted for use in this study:

	<u>Dry-weather gpcd</u>	<u>Annual Average gpcd</u>
Residential Only	90 gpcd	120 gpcd
Residential with other types of developments	110 gpcd	150 gpcd

WASTEWATER FLOW PROJECTIONS

Using the unit flow factors and population forecasts developed earlier, future wastewater flows in the study area were estimated and presented in Tables II-3 and II-4. Projected dry-weather and annual average wastewater flows for the years 2000 and 2010 on a serial-zone basis are summarized in Table II-3. Flow projections were also made for the cities of Seabrook, Shoreacres, El Lago, and Taylor Lake Village and are summarized in Table II-4.

The study area is projected to have dry-weather flows of 2.573 and 2.976 mgd for the years 2000 and 2010, respectively. Average dry-weather daily flows are normally used in estimating organic loadings for purposes of wastewater treatment plant design while annual average flows give an indication of how much flow may reach treatment plants on an annual basis.

TABLE II-1 EXISTING AND PROJECTED POPULATION THROUGH YEAR 2010
BREAKDOWN BY HGAC SERIAL ZONE

CENS TRAC	SERI ZONE	POPULATION				ANNUAL GROWTH			Comments
		1980	1990	2000	2010	1980-1990	1990-2000	2000-2010	
36601	4	0	0	0	0	-	-	-	Bayport Industrial District
36601	5	0	0	0	0	-	-	-	Bayport Industrial District
36601	6	0	0	0	0	-	-	-	Bayport Industrial District
36601	9	0	0	0	0	-	-	-	Bayport Industrial District
36601	10	0	0	0	0	-	-	-	Bayport Industrial District
36601	11	0	0	0	0	-	-	-	Bayport Industrial District
36601	13	388	419	449	480	0.8%	0.7%	0.7%	Shoreacres
36601	14	129	140	150	160	0.8%	0.7%	0.7%	Shoreacres
36602	2	1,519	1,653	1,653	1,653	0.8%	0.0%	0.0%	Shoreacres & Pasadena
36700	1	74	91	131	171	2.1%	3.7%	2.7%	Seabrook & Bayport Industrial District
36700	2	0	0	0	0	-	-	-	Seabrook & Bayport Industrial District
36700	3	0	0	0	0	-	-	-	Bayport Industrial District
36700	4	0	0	521	1,042	-	-	7.2%	Seabrook & Bayport Industrial District
36700	5	669	820	1,180	1,541	2.1%	3.7%	2.7%	Seabrook & Pasadena
36801	1	3,189	5,216	5,824	6,432	5.0%	1.1%	1.0%	Seabrook, El Lago & Taylor Lake Village
36801	2	787	1,287	1,437	1,587	5.0%	1.1%	1.0%	Seabrook
36801	3	430	704	786	868	5.0%	1.1%	1.0%	Seabrook
36802	1	2,996	2,892	3,924	4,956	-0.4%	3.1%	2.4%	Seabrook
36802	2	214	206	282	357	-0.4%	3.2%	2.4%	Seabrook
36900	1	864	959	959	959	1.1%	-0.0%	0.0%	Taylor Lake Village & Armand Park
36900	2	2,562	2,845	3,067	3,289	1.1%	0.8%	0.7%	Taylor Lake Village & Pasadena
36900	3	0	0	0	0	-	-	-	Herman & FDC Properties
36900	4	1,175	1,304	1,386	1,467	1.1%	0.6%	0.6%	Taylor Lake Village & Pasadena
37000	11	0	0	0	0	-	-	-	Clear Lake Oil Field
37000	12	0	0	0	0	-	-	-	Clear Lake Oil Field
37000	15	189	544	2,664	2,664	11.1%	17.2%	0.0%	Brookwood subdivision
37000	16	90	259	313	368	11.1%	1.9%	1.6%	University of Houston Campus
37303	5	188	250	780	1,310	2.9%	12.1%	5.3%	Lunar Institute & Armand Park
Total		15,465	19,588	25,506	29,304	2.4%	2.7%	1.4%	

Note:

1. 1980 populations were derived using 1980 census data.
2. 1990 populations were estimated using preliminary 1990 census data.
3. Data shown include only the portion of serial-zone populations within the study area.
4. See Exhibit 4 for census-tract and serial-zone boundaries.

TABLE II-2 EXISTING AND PROJECTED POPULATION THROUGH YEAR 2010
BREAKDOWN BY CITY

City	POPULATION					TWDB TWDB	
	1980	1985	1990	2000	2010	2010 Low	2010 High
Seabrook	4,670	4,957	6,642	8,804	10,827	6,815	7,235
Shoreacres	1,260	1,439	1,306	1,591	1,631	2,088	2,217
El Lago	3,129	3,234	3,254	3,611	3,731	4,266	4,529
Taylor Lake Village	3,669	3,700	3,390	4,096	4,456	5,022	5,332
Total	12,728	13,330	14,592	18,102	20,645	18,191	19,313

Note:

1. 1980 populations are census data.
2. 1985 populations are Texas Water Development Board estimates.
3. 1990 populations are preliminary census data.
4. TWDB 2010 Lows are TWDB year 2010 low series projections.
4. TWDB 2010 Highs are TWDB year 2010 high series projections

TABLE II-3 PROJECTED WASTEWATER FLOWS THROUGH YEAR 2010
BREAKDOWN BY SERIAL ZONE

CENSU TRACT	SERIA ZONE	Dry-Weather Flow (mgd)			Annual Average Flow (mgd)		
		1990	2000	2010	1990	2000	2010
36601	4						
36601	5						
36601	6						
36601	9						
36601	10						
36601	11						
36601	13	0.038	0.040	0.043	0.050	0.054	0.058
36601	14	0.013	0.013	0.014	0.017	0.018	0.019
36602	2	0.149	0.149	0.149	0.198	0.198	0.198
36700	1	0.008	0.012	0.015	0.011	0.016	0.021
36700	2						
36700	3						
36700	4		0.057	0.115		0.078	0.156
36700	5	0.074	0.106	0.139	0.098	0.142	0.185
36801	1	0.574	0.641	0.708	0.782	0.874	0.965
36801	2	0.142	0.158	0.175	0.193	0.216	0.238
36801	3	0.077	0.086	0.095	0.106	0.118	0.130
36802	1	0.318	0.432	0.545	0.434	0.589	0.743
36802	2	0.023	0.031	0.039	0.031	0.042	0.054
36900	1	0.086	0.086	0.086	0.115	0.115	0.115
36900	2	0.256	0.276	0.296	0.341	0.368	0.395
36900	3						
36900	4	0.117	0.125	0.132	0.157	0.166	0.176
37000	11						
37000	12						
37000	15	0.049	0.240	0.240	0.065	0.320	0.320
37000	16	0.028	0.034	0.040	0.039	0.047	0.055
37303	5	0.027	0.086	0.144	0.037	0.117	0.197
Total		1.979	2.573	2.976	2.675	3.477	4.024

Note: Industrial Wastewater Flows in Bayport Industrial District
are not included.

TABLE II-4 PROJECTED WASTEWATER FLOWS THROUGH YEAR 2010
BREAKDOWN BY CITY

City	Dry-Weather Flow (mgd)			Annual Average Flow (mgd)		
	1990	2000	2010	1990	2000	2010
Seabrook	0.844	1.072	1.327	1.150	1.462	1.809
Shoreacres	0.118	0.143	0.147	0.157	0.191	0.196
El Lago	0.293	0.325	0.336	0.390	0.433	0.448
Taylor Lake Village	0.305	0.369	0.401	0.407	0.492	0.535
Total	1.559	1.909	2.210	2.104	2.578	2.987

At the present time, seven municipal and 12 industrial wastewater discharge permits have been issued by the TWC within the study area. Based on information obtained from the TWC's Houston district office, Table III-1 summarizes the names, permit numbers and types, permit flows, receiving streams, and segment numbers of these permit holders. Their locations are shown in Exhibit 5. TWC records indicate that three of the municipal permit holders (i.e., the City of Pasadena, Lexel Establishment, and L.H.Homan) have not constructed their wastewater treatment facilities. Information concerning each of these existing wastewater permittees is discussed below.

CLEAR LAKE CITY WATER AUTHORITY (PERMIT NO.10539-001)

CLCWA owns and operates a wastewater collection and treatment system that serves an area approximately bounded on the southwest by Old Galveston Road, on the southeast by NASA Road 1, on the northeast by Red Bluff Road and Big Island Slough, and on the northwest by Ellington Air Field and Genoa-Red Bluff Road. The treatment plant utilizes an activated sludge process and is permitted for an average flow of 6.75 million gallons per day (mgd). A flow diagram of the treatment plant is shown in Exhibit 6. The plant is currently treating an average daily flow of 5.4 mgd and has been consistently meeting the permitted effluent limits of 5 milligrams per liter (mg/l) Biochemical Oxygen Demand (BOD₅), 12 mg/l Total Suspended Solids (TSS), and 2 mg/l Ammonia Nitrogen (NH₃- N). Effluent from the plant is discharged into Horsepen Bayou, thence into Armand Bayou and Clear Lake. Because existing plant flows have reached 75 percent of the permitted capacity, CLCWA has begun the process of expanding the plant to a total capacity of 9.0 mgd. The portion of the study area currently served by The CLCWA plant includes the Brookwood subdivision, the University of Houston-Clear Lake, sections of the City of Pasadena along NASA Road 1, and the western portion of the City of Taylor Lake Village. Sewage from the Taylor Lake Village area first discharges into the Clear Lake Forest Pump Station. From there, it is pumped through a 16-inch force main to the CLCWA WTP for treatment. Existing trunk-sewer layout is shown in Exhibit 7.

HARRIS COUNTY WCID NO.75 (PERMIT NO.10106-001)

Harris County WCID No.75 owns a wastewater collection and treatment system which serves the eastern section of the City of Taylor Lake Village, including Timber Cove and portions of Taylor Lake Estates. The treatment plant is currently operated by GCWDA. The prefabricated package plant utilizes the activated sludge process and is permitted for an average flow of 150,000 gallons per day (gpd). Plant effluent is discharged into Taylor Lake, thence into Clear Lake. A schematic of the plant is shown in Exhibit 8. The plant is treating an average daily flow of 87,000 gpd. According to the TWC field inspection report, the plant occasionally was unable to meet the permitted effluent limits of 5 mg/l BOD₅, 12 mg/l TSS, and 2 mg/l NH₃-N. Some of the permit violations were results of excessive I/I in the collection system. During wet-weather periods, peak plant flows sometimes reached six to seven times the average dry-weather flows. WCID No.75 has undertaken a sewer system rehabilitation program to reduce the excessive I/I. A June 12, 1990 correspondence from the TWC concerning the permit renewal of this facility indicates that the plant may require expansion or upgrading in order to maintain its current permitted capacity rating. In light of these problems, considerations should be given to the feasibility of abandonment of this plant and diversion of flow to a regional facility. The layout of major trunk sewers in the WCID No.75 system is shown in Exhibit 7.

HARRIS COUNTY WCID NO.50 (PERMIT NO. 10234-001)

Harris County WCID No.50 owns and operates a wastewater collection and treatment system which serves the City of El Lago and a small portion of the City of Taylor Lake Village. The oxidation ditch treatment plant which was constructed in 1980 utilizes the activated sludge process and is permitted for an average flow of 540,000 gpd. Plant effluent is discharged into Taylor Lake, thence into Clear Lake. A flow schematic of the plant is shown in Exhibit 9. The plant is currently treating an average daily flow of 370,000 gpd. According to the TWC field inspection report, the plant was able to meet the permitted effluent limits of 5 mg/l BOD₅, 12 mg/l TSS, and 2 mg/l NH₃-N. There have been some compliance problems relating to overall appearance and sludge handling. Since the City of El Lago is almost fully developed, there is no need to further expand the existing

treatment plant. However, when the plant reaches its design life, considerations should be given to the feasibility of diverting flow to a regional facility. The layout of major trunk sewers in the WCID No.50 system is shown in Exhibit 7.

CITY OF SEABROOK (PERMIT NO.10671-001)

The City of Seabrook currently owns and operates a wastewater collection and treatment system which serves all areas within its corporate limits plus a small subdivision (El Jardin) located in the City of Pasadena corporate limits immediately northeast of the City near the Bay. The recently expanded treatment plant utilizes an activated sludge process and is permitted for an average flow of 2.5 mgd. Plant effluent is discharged into Galveston Bay. A schematic of the plant is shown in Exhibit 10. The plant is currently treating an average daily flow of 1.12 mgd. The plant has been able to meet the permitted effluent limits of 20 mg/l BOD₅ and 20 mg/l TSS. Based on the flow projections presented in Section II, this plant should have enough capacity to serve the City through year 2010. However, because of its proximity to the bay and low ground elevation, the plant may be vulnerable during severe weather conditions. Existing trunk sewer layout is shown in Exhibit 7.

CITY OF PASADENA (PERMIT NO.10053-008)

This proposed activated sludge plant is planned to be located at approximately 2,000 feet north of the intersection of Space Center Boulevard and NASA Road 1. The not-yet-constructed plant is intended to serve a tract of land owned by Rice University and formerly occupied by the Lunar and Planetary Institute on NASA Road 1. The permit was secured by the City of Pasadena for an entity interested in developing the property. However, no development plan or construction schedule has been established at the present time. Permitted average flow and effluent limits are 300,000 gpd, 5 mg/l BOD₅, 12 mg/l TSS, and 2 mg/l NH₃-N. Plant effluent would be discharged into Mud Lake, thence into Clear Lake.

LEXEL ESTABLISHMENT (PERMIT NO.12545-001)

The original permit for this not-yet-constructed wastewater treatment facility was issued to Irvin Kaplan on October 11, 1983 to serve the Kirby Road Development located near the intersection of Kirby Road and NASA Road 1. The permit was subsequently transferred to Gad Zeevi dba (doing business as) Lexel Establishment on August 11, 1988 and was renewed on November 15, 1988. This proposed activated sludge plant is planned to be located approximately 700 feet northwest of the intersection of Kirby Road and NASA Road 1 and to have an ultimate average flow capacity of 200,000 gpd (100,000 gpd interim capacity). A plant schematic based on the information contained in the permit application is shown on Exhibit 11. Permitted effluent limits are 5 mg/l BOD₅, 12 mg/l TSS, and 2 mg/l NH₃-N. Plant effluent will be discharged through a pipe into Clear Lake. According to the TWC July 26, 1990 inspection report, no construction plan has been established for this facility.

L.H.HOMAN (PERMIT NO.13382-001)

This not-yet-constructed facility is planned to be located near the intersection of Red Bluff Road and Kirby Road to serve the Lake Estates development. The proposed activated sludge plant, when constructed, will be able to treat an average flow 150,000 gpd. A plant schematic based on the information contained in the permit application is shown on Exhibit 12. Permitted effluent limits for this facility are 5 mg/l BOD₅, 12 mg/l TSS, and 2 mg/l NH₃-N. Plant effluent will be discharged through a pipe into Taylor Lake, thence into Clear Lake. TWC permit provisions require that within 180 days after a regional facility is operational and has the capacity to serve the subject development, the permit holder should discontinue the discharge from this facility and divert the flow to the regional plant.

GULF COAST WASTE DISPOSAL AUTHORITY - BAYPORT (01054-001)

GCWDA owns and operates a wastewater collection and treatment system which serves the Bayport Industrial District, an area approximately bounded on the south by the Pasadena city limit, on the east by Galveston Bay, on the north by Fairmont Parkway and the La Porte city limit, and on the west by Red Bluff Road. The treatment plant utilizes the

activated sludge process and is permitted for an average flow of 15.8 mgd. Plant effluent is discharged into the Bayport Ship Channel, thence into Galveston Bay. A flow diagram of the treatment plant is shown in Exhibit 13. The plant is currently treating an average daily flow of 9 mgd. The plant holds an industrial discharge permit and is consistently meeting the permitted effluent limits. TWC permitted effluent limits for this facility are summarized in Table III-2. The GCWDA plant currently serves more than 40 industries located in the Bayport Industrial District and two municipal entities, the City of Shoreacres and the Bayshore Municipal Utility District (MUD). This facility has been classified by U.S. Environmental Protection Agency (EPA) as a Publicly Owned Treatment Work (POTW) and is subject to the EPA industrial pretreatment requirements.

The influent collection system of this plant consists of two parallel concrete lined collection channels which extend 2.25 miles into the manufacturing complex. One channel carries "clean stream" wastes which are low strength wastes limited to 20 mg/l or less BOD and which do not require significant biological treatment. The other channel carries "bio-san" wastes (process wastewater and contaminated stormwater runoff) which have combined averages of approximately 800 mg/l BOD and 600 mg/l TOC. As shown in Exhibit 7, the industries and municipalities pump their individual waste streams to the collection channels through pipelines.

OTHER INDUSTRIAL WASTEWATER PERMITS

In addition to the GCWDA Bayport facility, there are 11 industrial wastewater permit holders within the study area. However, only the M.A. Hanna Company owns and operates its own wastewater treatment facility and discharges treated industrial and domestic effluent. The remaining ten TWC industrial permits are for discharges of uncontaminated stormwater runoff only. Process wastewater, contaminated stormwater, and domestic sewage generated from these facilities are discharged into the GCWDA Bayport plant for treatment. A brief description of these permits is given below.

M.A. Hanna Company (01028-001) owns and operates a prefabricated 200,000-gpd extended aeration unit which treats wastewater generated from its plastics compounding plant located on the west side of State Highway (SH) 146 approximately two miles north of

Seabrook. A flow diagram of this facility is shown in Exhibit 14. According to the TWC field inspection report, the plant has been able to meet the permitted effluent limits of 20 mg/l BOD₅, 84 mg/l Chemical Oxygen Demand (COD), 42 mg/l TSS, and 17 mg/l of Oil and Grease (O&G). The plant is currently treating an average flow of 120,000 gpd. Effluent is discharged through a drainage ditch to Pine Gully, thence into Galveston Bay.

Hoechst Celanese Chemical Group (02590-001) operates an organic chemical bulk storage terminal located approximately .5 mile east of intersection of State Highway 146 and Port Road in the Bayport Industrial District. The TWC permit allows the company to discharge uncontaminated utility water and stormwater runoff from the storage terminal as long as the permitted parameters of 55 mg/l Total Organic Compound (TOC) and 15 mg/l O&G are not exceeded. Stormwater effluent is discharged through a pipe to a drainage ditch and thence into the Bayport Ship Channel.

Baytank (Houston) Inc. (02547-001) operates a bulk liquid storage and tank terminal located at 12211 Port Road in the Bayport Industrial District. The TWC permit currently allows the company to discharge uncontaminated filter backflush water and stormwater runoff from the storage terminal as long as the permitted parameters of 55 mg/l COD, 250 mg/l TSS, and 15 mg/l O&G are not exceeded. Additional limits will be added to the permit conditions in 1992 to include 1.0 mg/l Chlorinated Hydrocarbon, 0.1 mg/l Phenolic Compounds, 1.0 mg/l NH₃-N, and 0.5 mg/l Organic-N. Stormwater effluent from this facility is discharged into the Bayport Ship Channel. TWC records indicate that in the past this facility had some problems meeting the stormwater discharge requirements.

PetroUnited Terminals (02110-001) operates a bulk liquid storage and tank terminal located at 11666 Port Road in the Bayport Industrial District. The TWC permit allows the company to discharge uncontaminated stormwater from the storage terminal facility as long as the permitted parameters of 150 mg/l COD and 15 mg/l O&G are not exceeded. Stormwater effluent is discharged into a drainage ditch, thence into Bayport Ship Channel. The TWC inspection report did not indicate any major problems with this facility.

Bayou Cogeneration Plant (02915-001) is a joint venture project of Big Three Industries, Inc. and EAPD Bayou Cogeneration, Inc. The cogeneration (steam and electric power production) plant is located at 11777 Bay Area Boulevard in the Bayport Industrial

District. The TWC permit allows the plant to discharge uncontaminated stormwater with permitted limits of 200 mg/l COD and 15 mg/l O&G. Stormwater effluent is discharged through a drainage ditch into Taylor Bayou, thence into Taylor Lake and Clear Lake. The TWC inspection report did not indicate any major problems with this facility.

Big Three Industrial Gas Inc. (02916-001) operates an air separation plant manufacturing oxygen, nitrogen, and argon gases. The facility is located at northwest corner of Bay Area Boulevard and Choate Road in the Bayport Industrial District. The TWC permit allows the company to discharge uncontaminated stormwater from this facility as long as the permitted parameters of 55 mg/l TOC and 15 mg/l O&G are not exceeded. Stormwater effluent is discharged through a drainage ditch into Taylor Bayou, thence into Taylor Lake and Clear Lake. The TWC inspection report did not indicate any major problems with this facility.

ARCO Chemical Company (02756-001) operates an organic chemicals manufacturing plant located at 10801 Choate Road in the Bayport Industrial District. The TWC permit allows the company to discharge uncontaminated stormwater from this facility as long as the permitted parameters of 55 mg/l TOC and 15 mg/l O&G are not exceeded. Stormwater effluent is discharged through a drainage ditch into Taylor Bayou, thence into Taylor Lake and Clear Lake. The TWC inspection report did not indicate any major problems with this facility.

Hoechst Celanese Chemical Group (02571-001) operates an organic chemicals manufacturing plant located at 9502 Bay Area Boulevard in the Bayport Industrial District. The TWC permit is for the discharge of uncontaminated stormwater not to exceed 55 mg/l TOC and 15 mg/l O&G. Stormwater effluent is discharged through a drainage ditch into Taylor Bayou, thence into Taylor Lake and Clear Lake. Process wastewater from this plant is either pumped over to the GCWDA Bayport plant for treatment or disposed of through two onsite injection wells. The TWC inspection report did not indicate any major problems with this facility.

Oxy Petrochemicals Inc. (03029-001) operates an organic chemicals manufacturing plant located at 5757 Underwood Road, approximately .5 mile north of Red Bluff Boulevard in the Bayport Industrial District. The TWC permit allows the company to discharge

uncontaminated stormwater at permitted limits of 75 mg/l TOC and 15 mg/l O&G. Stormwater effluent is discharged through a drainage ditch into Big Island Slough, thence into Armand Bayou and Clear Lake. The TWC inspection report did not indicate any major problems with this facility.

ICI Americas, Inc. (02654-001) operates an organic herbicides manufacturing plant located at 5757 Underwood Road, approximately .5 mile north of Red Bluff Boulevard in the Bayport Industrial District. The TWC permit allows the company to discharge uncontaminated stormwater from this facility as long as the permitted parameters of 75 mg/l TOC, 15 mg/l O&G, and 20 mg/l paraquat are not exceeded. Stormwater effluent is discharged through a drainage ditch into Big Island Slough, thence into Armand Bayou and Clear Lake. The TWC inspection report did not indicate any major problems with this facility.

Rexene Products Company (02600-001) operates a polypropylene and polyethylene manufacturing plant located at 9802 Fairmont Parkway in the Bayport Industrial District. The ownership of this plant has recently been changed to Lyondell Polymers Corporation. The TWC permit is for the discharge of uncontaminated stormwater at permitted limits of 150 mg/l COD and 15 mg/l O&G. Stormwater effluent is discharged into Big Island Slough, thence into Armand Bayou and Clear Lake. The TWC inspection report did not indicate any major problems with this facility.

TABLE III-1 Texas Water Commission Wastewater Discharge Permits

Permit Holder	Permit No.	Type*	Average Flow (mgd)	Receiving Streams	Segment
1 City of Pasadena	10053-008	D	0.30	Armand Bayou Tidal	1113
2 Clear Lake Water Authority	10539-001	D	6.75	Armand Bayou Tidal	1113
3 City of Seabrook	10671-001	D	2.50	Galveston Bay	2421
4 HCWCID No.50	10243-001	D	0.54	Clear Lake	2425
5 HCWCID No.75	10106-001	D	0.15	Clear Lake	2425
6 L.H.Homan	13382-001	D	0.15	Clear Lake	2425
7 Lexel Establishment	12545-001	D	0.20	Clear Lake	2425
8 M.A. Hanna Company	01028-001	I	0.20	Galveston Bay	2421
9 GCWDA Bayport Central	01054-001	I	15.80	Bayport Channel	2438
10 ICI Americas, Inc.	02654-001	IS	N/A	Armand Bayou Tidal	1113
11 Oxy Petrochemicals, Inc.	03029-001	IS	N/A	Armand Bayou Tidal	1113
12 Rexene Products Company	02600-001	IS	N/A	Armand Bayou Tidal	1113
13 Arco Chemical Company	02756-001	IS	N/A	Clear Lake	2425
14 Bayou Cogeneration Plant	02915-001	IS	N/A	Clear Lake	2425
15 Big 3 Industrial Gas Inc.	02916-001	IS	N/A	Clear Lake	2425
16 Hoechst Celanese Chemical	02571-001	IS	N/A	Clear Lake	2425
17 Baytank (Houston) Inc.	02547-001	IS	N/A	Bayport Channel	2438
18 Hoechst Celanese Chemical	02590-001	IS	N/A	Bayport Channel	2438
19 PetroUnited Terminal	02110-001	IS	N/A	Bayport Channel	2438

* D: Domestic Wastewater
 I: Industrial Wastewater
 IS: Uncontaminated Stormwater Only

Note: See Exhibit 5 for location.

TABLE III-2 TEXAS WATER COMMISSION PERMIT EFFLUENT LIMITS
GCWDA BAYPORT WASTEWATER TREATMENT PLANT

Interim Limits (Current through June 30, 1991)

Effluent Characteristics	Discharge Limitations		
	Daily Average (lbs/day)	Daily Maximum (lbs/day)	Single Grab (mg/l)
Flow (MGD)	(Report)	(Report)	N/A
Biochemical Oxygen Demand (5 day)	2,650	5,300	60
Total Organic Carbon	7,920	15,840	180
Total Suspended Solids	3,950	7,900	100
Oil and Grease	1,320	2,640	30
Ammonia as N	485	970	10
Chromium, Total	12.5	25	1.0
Cyanide, Free	(Report, mg/l)	(Report, mg/l)	N/A
Copper, Total	(Report, mg/l)	(Report, mg/l)	N/A
Mercury, Total	(Report, mg/l)	(Report, mg/l)	N/A
Silver, Total	(Report, mg/l)	(Report, mg/l)	N/A
Lead, Total	(Report, mg/l)	(Report, mg/l)	N/A
Zinc, Total	31	62	2.0
Benzene	N/A	0.125	0.250
Toluene	N/A	0.225	0.450
Paraquat	N/A	0.500	1.00
Sodium Salt of Acifluorfen	N/A	0.500	1.00
4-Nitrophenol	N/A	0.100	0.200
Chlorobenzene	N/A	0.100	0.200
2, 4, 6 Trichlorophenol	N/A	0.100	0.200
2-Chlorophenol	N/A	0.100	0.200
Chloroform	N/A	0.200	0.400
1, 1, 1 Trichloroethane	N/A	0.100	0.200

TABLE III-2 TEXAS WATER COMMISSION PERMIT EFFLUENT LIMITS
GCWDA BAYPORT WASTEWATER TREATMENT PLANT (Cont.)

Final Limits (Beginning July 1, 1991)

Effluent Characteristics	Discharge Limitations		
	Daily Average (lbs/day)	Daily Maximum (lbs/day)	Single Grab (mg/l)
Flow (MGD)	(Report)	(Report)	N/A
Biochemical Oxygen Demand (5 day)	2,650	5,300	60
Total Organic Carbon	7,920	15,840	180
Total Suspended Solids	3,950	7,900	100
Oil and Grease	1,320	2,640	30
Ammonia as N	485	970	10
Chromium, Total	12.5	25	1.0
Cyanide, Free	2.64	7.92	0.100
Copper, Total	1.32	3.96	0.100
Mercury, Total	0.26	0.79	0.010
Silver, Total	0.48	1.00	0.010
Lead, Total	8.31	17.55	0.300
Zinc, Total	20.3	43.00	0.500
Benzene	N/A	0.125	0.250
Toluene	N/A	0.225	0.450
Paraquat	N/A	0.500	1.00
Sodium Salt of			
Acifluorfen	N/A	0.500	1.00
4-Nitrophenol	N/A	0.100	0.200
Chlorobenzene	N/A	0.100	0.200
2, 4, 6 Trichlorophenol	N/A	0.100	0.200
2-Chlorophenol	N/A	0.100	0.200
Chloroform	N/A	0.200	0.400
1, 1, 1 Trichloroethane	N/A	0.100	0.200

SECTION IV - REGIONAL WASTEWATER SYSTEM ALTERNATIVES

IV-1

Future population in the study area is projected to grow from approximately 20,000 people in 1990 to 30,000 in 2010. As a result, domestic wastewater flows are expected to increase from 2.0 mgd to 3.0 mgd (dry-weather flow), or from 2.7 mgd to 4.0 mgd (annual average flow). Wastewater needs associated with this continued growth must be met by expansion of existing facilities, construction of new facilities, or a combination of both. As discussed in Section I, proliferation of small wastewater systems in the past has caused serious water quality and environmental problems in addition to not being cost effective. Large regional wastewater facilities can avoid or minimize these problems.

REQUIREMENTS FOR REGIONAL FACILITIES

The study objective of this project stipulates that the proposed regional plan should be environmentally acceptable, meet applicable regulatory requirements, provide for cost-effective sizes, be financially and politically implementable, and accommodate both short- and long-term development needs. The applicability of each of these requirements to the proposed regional system is briefly discussed below.

1. **Environmentally Acceptable** - The proposed regional system should result in improved water quality and minimal deterioration or damage to other important environmental resources. In order to meet this criterion, it is imperative that each regional treatment plant have a crew of well-trained staff to properly operate, maintain, and monitor the facility around the clock and produce effluent of good quality. The selection of locations for plant sites or trunk routes should consider avoiding or minimizing any damage to wetlands and other resources.
2. **Meet Regulatory Criteria and Rules** - The current and proposed effluent and stream water quality standards, as well as required treatment levels, must be considered in selecting the locations (plants and outfalls) and treatment processes of the proposed facilities. Current water quality standards as promulgated by the TWC for stream segments in the project area are summarized in Table IV-1. Other than segment 2438 (Bayport Channel) and segment 2421 (Galveston Bay), stream segments in the study area already have some of the most stringent requirements in the state. Treatment levels of existing plants have been discussed earlier in Section III. The Texas Water Commission has indicated that future treatment limits for facilities discharging to Galveston Bay will likely become more restrictive. The feasibility of existing and future regional facilities to meet the more stringent requirements for Galveston Bay must be considered.

3. **Provide for Cost Effective Sizes and Locations** - The selection of a regional facility must be evaluated from a life-cycle cost standpoint to ensure that the recommended system has the most cost-effective sizes and locations. Considerations should be given to the expansion of existing facilities. When area for expansion is available at an existing treatment plant location, expansion of this facility often provides the most cost-effective solution. Alternative treatment plant and outfall locations, as well as treatment level requirement, also need to be evaluated since they will impact the overall cost of the system.
4. **Is Financially and Politically Implementable** - The proposed plan needs to be fair, realistic, and prospective in order to be financially and politically acceptable and implementable. The plan should allow for but not impede the continued land development in the free market environment. The implementation costs must be reasonable and affordable and provide for the fair allocation of costs among developers, existing and future residents, and various municipalities and other regional entities.
5. **Meets the Short- and Long-Term Development Needs** - The proposed regional plan must not only provide a long-range solution to the wastewater needs in the area, but also consider the short-term or immediate development needs within the one to five year horizon.

By applying these general requirements to the project area, three regional alternatives were developed for evaluation in this study. Each of the proposed regional wastewater facilities included as part of these alternatives generally has the following characteristics:

1. A plant capacity of 3 to 5 mgd or more
2. Owned and/or operated by appropriate wastewater management agencies with good track records
3. Enough site area available for future expansion or upgrading of treatment processes
4. Flexibility to accommodate more stringent future treatment levels if imposed by regulatory agencies
5. Optimally located in a service area to minimize excessive collection system costs (only to the extent that Item 7 below has been complied with)
6. Capable of serving immediate and long-term wastewater needs at reasonable costs

7. Effluent discharge points located where least water quality impacts are likely to occur

The three alternative regional wastewater systems discussed below have been developed by applying the above criteria. Emphasis was placed on implementability of the proposed plan. In the past, many regional wastewater plans failed to address this issue and resulted in paper plans that could not be carried out in reality. For this reason, it should be pointed out that although it is desirable to abandon small existing treatment plants and to divert their flows to a regional facility, such an option must be evaluated carefully in terms of water quality, financial and political implementability, and cost effectiveness.

REGIONAL ALTERNATIVE 1

This alternative, depicted in Exhibit 15, divides the entire project area into three regional service areas (A, B, and C). Area C is further divided into two subareas, C1 and C2. Ultimately, each of the service areas will be served by one or two regional wastewater treatment plants. Important planning elements concerning each regional service area are discussed below.

SERVICE AREA A

This area is bounded on the west by Red Bluff Road, on the south by the Seabrook city limit, on the east by Todville Road and Galveston Bay, and on the north by the study area boundary. The community of El Jardin located near Galveston Bay in the City of Pasadena is excluded from this area. Serial zones 36601.04, 36601.05, 36601.06, 36601.09, 36601.10, 36601.11, 36601.13, 36601.14, 36602.02, 36700.03, and 36900.03 are wholly within Area A while 36700.01, 36700.02, and 36700.04 are partially within it.

The predominant land use for this area has been and will continue to be for industrial development since approximately 90 percent of Area A is in the Bayport Industrial District. As shown in Exhibit 5, the TWC has issued 12 industrial wastewater discharge permits but no domestic permits in this area. With the exception of the GCWDA Bayport plant and the M.A. Hanna Company plant, these industrial permit holders are allowed to discharge only uncontaminated stormwater or utility water. Process wastewater

and contaminated stormwater from these industries are transported to the GCWDA plant for treatment. The M.A. Hanna facility owns and operates an activated sludge plant treating process wastewater and sewage generated from the plastics compounding operation. The 15.8-mgd GCWDA Bayport WTP was planned and designed from the very beginning to provide wastewater services to the entire Bayport Industrial District. Through the years, it has also provided services to municipal customers such as the City of Shoreacres and Bayshore MUD. The facility is well operated and maintained by the GCWDA. In light of these merits, the GCWDA Bayport WTP is recommended as the regional facility for Area A.

Domestic wastewater flows (dry-weather average) in Area A are relatively low and have been projected to increase from 200,000 gpd in 1990 to 260,000 gpd in 2010. Although it is difficult to project how much industrial process wastewater flow will be generated by future industries to be located in the area, past experience indicates that the GCWDA facility should have adequate capacity to serve the future needs since it is currently serving more than 40 industries and only operating at approximately 60 percent of the 15.8-mgd design capacity. The plant also has enough land for future expansion or treatment process upgrading purposes. Wastewater from future developments in the area will continue to be transported to the regional plant, as shown in Exhibit 15, by collection pipelines to be installed by individual customers.

The City of Shoreacres, the only residential development in Area A, is already served by the GCWDA facility. The El Jardin community in Pasadena is currently and will continue to be served by the City of Seabrook and, therefore, is excluded from this regional service area.

Service Area B

This area is bounded on the north by Red Bluff Road, on the east by Taylor Lake, and on the south and west by the study area boundary (See Exhibit 15). Service area B encompasses serial zones 36900.01, 36900.02, 36900.04, 37000.11, 37000.12, 37000.15, 37000.16, and 37303.05. Major land uses in this service area include Clear Lake Oil Field, Armand Bayou Park and Nature Center, the University of Houston-Clear Lake, the Brookwood subdivision, the City of Taylor Lake Village, and a portion of the City of

Pasadena along NASA Road 1. Major growth is projected to occur in the Brookwood subdivision, in and around the university campus, along NASA Road 1, and in the City of Taylor Lake Village. It is not anticipated that wastewater services will be needed at the oil field or Armand Bayou Park. Since no development plan is known for the triangular area between Red Bluff Road and Armand Bayou Park, marked as Area 'M' in Exhibit 15, no wastewater needs are projected for this area. However, service can be provided to this area by the CLCWA wastewater system, if needed. Area B is currently served by two existing wastewater treatment plants, CLCWA and Harris County WCID 75 (see Exhibit 15). With the exception of the Timber Cove subdivision and part of Taylor Lake Estates, wastewater from the entire Area B is currently transported to and treated by the CLCWA plant. Approximately 90 percent of the area is within the CLCWA jurisdictional boundary. Although portions of Pasadena along NASA Road 1 and the western half of Taylor Lake Village are outside the CLCWA jurisdictional area, limited wastewater services are provided to these areas by the Authority through special contractual arrangements. The WCID 75 plant provides wastewater treatment for the Timber Cove and Taylor Lake Estates subdivisions in the City of Taylor Lake Village. The plant is in need of upgrading to meet its permit requirements, but has a limited site area for major expansion. In addition to these two existing facilities, three wastewater discharge permits (i.e., the City of Pasadena, L.H.Homan, and Lexel Establishment, shown in Exhibit 5) were issued by the TWC for treatment plants to be constructed in this area. No definitive construction schedule has been established for any of these facilities. As discussed below, the proposed regional system will be able to serve these developments.

Total wastewater flows from Area B have been projected to increase in the next 20 years from 563,000 gpd to 938,000 gpd in terms of dry-weather flows, or from 754,000 gpd to 1,258,000 gpd in terms of annual average flows. Since the total projected flow is well below the 3-mgd minimum capacity recommended for a regional facility, the construction of a new regional WTP is not recommended. Rather, the CLCWA WTP is proposed to serve as the regional facility in Area B. As in the case of the GCWDA Bayport plant, the CLCWA WTP has been planned and designed from its inception as a regional facility to serve various developments within the Authority's jurisdiction. The plant is well operated and maintained by a regional authority with adequate staff and is already serving

a major part of the service area. It has enough site area for future expansion and is in the process of enlargement from 6.75 mgd to 9.0 mgd. For these reasons, the CLCWA WTP is recommended as the regional WTP for Service Area B.

For those areas located in Area B but outside the Authority's current jurisdiction, it is recommended that the CLCWA immediately include them in its future facility planning process and establish cost and technical guidelines, as well as standard agreements for allowing these entities to be served by the CLCWA. In order to better serve developments in an area bounded on the north by Red Bluff Road, on the east by Taylor Lake, on the south by Clear Lake, and on the west by Mud Lake (serial zones 36900.01, 36900.02, and 36900.04), the CLCWA has already expanded the Clear Lake Forest Pump Station to a firm capacity of 2,300 gallons per minute. A firm capacity is the capacity of a pump station with its largest pump out of service. Based on the design calculations prepared by the Authority's engineering consultant, the pump station has been designed to handle an average dry-weather flow of 830,000 gpd and a peak flow of 3.31 mgd. Such capacity should be able to provide the needed capacity for this area through the year 2010, including flow diverted from the WCID 75 service area. Ultimate peak flows from this area depend greatly on land uses under the built-out condition. Based on land-use assumptions shown in Table IV-2, ultimate peak flows from this area have been projected to be 4.20 mgd. To accommodate the ultimate peak flow, the pump station and/or the 16-inch force main from the pump station to the CLCWA plant may have to be upgraded. One way to increase the flow capacity will be to construct a new segment of parallel force main on the west side of Mud Lake.

As discussed in Section III, the existing WCID 75 WTP may need upgrading so that it can consistently meet the TWC permit requirements. WCID 75 should consider the option of abandoning its WTP and diverting flow to the CLCWA plant because, in the long run, diversion may prove to be more cost effective than upgrading the existing plant. The elimination of discharge to Taylor Lake will also enhance the water quality.

Since the construction of the original CLCWA plant was financed through a grant from the EPA's construction grants program, this plant is not allowed to serve any areas located within the 100-year floodplain. This may preclude some of the tracts (e.g., Lake Estates) within Service Area B from being served by this plant. However, since the

CLCWA is currently in the process of expanding the existing plant, the additional capacity available from this expansion may be used to serve the areas located in the floodplain without violating the previous grant condition. Such possibility, however, must be evaluated and confirmed by the CLCWA's legal counsel. A tract where the Lunar Institute was previously located can be served by the CLCWA plant by constructing a pump station and a force main to the NASA collection system or directly to the regional plant. Although the City of Pasadena has obtained a discharge permit for a treatment plant proposed to be constructed on this site, it is more desirable from the water quality and environmental standpoints that this site is served by a regional facility. A preliminary layout of the proposed trunk sewers serving Area B is shown in Exhibit 15. The sizing of the proposed sewers is based on peak flows of four times the projected average dry-weather flows.

Service Area C

Area C, which includes subareas C1 and C2 as shown in Exhibit 15, is bounded on the west by Taylor Lake, on the south by Clear Lake, on the east by Galveston Bay, and on the north by the Seabrook city limit and Todville Road. Serial zones 36801.01, 36801.02, 36801.03, 36802.01, 36802.02, and 36700.05 are wholly within this area while 36700.01, 36700.02, and 36700.04 are partially within it. Area C includes the cities of Seabrook and El Lago, and portions of the cities of Taylor Lake Village and Pasadena (El Jardin community).

Area C is currently served by two existing wastewater treatment plants, Seabrook and Harris County WCID 50 (see Exhibit 15). The WCID 50 plant serves the City of El Lago and part of Taylor Lake Village. The Seabrook WTP serves the City of Seabrook and El Jardin in Pasadena. Wastewater service to El Jardin is provided by Seabrook through a special contractual agreement with the City of Pasadena. Seabrook has experienced moderate growth in the last decade and is expected to continue to grow. The WCID 50 service area, however, is almost fully developed.

By the year 2010, wastewater flows in Area C are projected to increase from 1.216 mgd to 1.774 mgd (dry-weather average flows) or from 1.655 mgd to 2.414 (annual average flows). Since the projected total flow is less than the 2.5-mgd capacity of the existing Seabrook plant or the minimum capacity (3 mgd) recommended for a regional

facility, the construction of a new regional WTP is not recommended at the present time. Instead, the existing Seabrook WTP and WCID 50 plants are recommended to continue treating wastewater from their respective service areas. Should more restrictive treatment level is required by the TWC in the future for facilities discharging into Galveston Bay, the existing Seabrook plant will need upgrading to meet such requirements. Since the area served by the WCID 50 is well developed, no expansion is needed for this facility. As long as it is properly operated and maintained and continuing effort is made to reduce I/I into the sewer system, the WCID 50 plant should be able to produce good effluent meeting permitted limits.

The City of Seabrook has bought seven acres of land near Red Bluff Road and Beechcraft Road and is planning to construct a new WTP at this site when capacity of the existing 2.5-mgd plant is reached. As proposed in Seabrook's wastewater master plan, the existing plant will then serve only the southern portion of the City while the new North WTP will serve the remainder of the City (see areas marked as C1 and C2 in Exhibit 15).

Since the WCID 50 WTP probably will have reached its service life by that time, it is recommended that the plant be abandoned and the flow diverted to the Seabrook North plant for treatment. Area C will then be served by two regional plants operated by a single entity, the City of Seabrook. The preliminary layout of the proposed regional system discussed above is shown in Exhibit 15.

REGIONAL ALTERNATIVE 2

This alternative is a modification to Regional Alternative 1. As shown in Exhibit 16, the entire study area is also divided into three regional service areas (A, B, and C) while Area C is further divided into subareas C1 and C2. Ultimately, each of these service areas will be served by one or two regional wastewater treatment plants. Important planning elements concerning each regional service area are discussed below.

Service Area A

Service Area A of Alternative 2 is very similar to that of Alternative 1. However, an area bounded on the north by Red Bluff Road, on the west by Kirby Road, on the south by Clear Lake, and on the east by Taylor Lake (see Exhibit 16) has been taken out of Area B

and included as part of Area A in this alternative. As in Alternative 1, the GCWDA Bayport plant will remain the recommended regional facility for Area A. A pump station and force main will be constructed along a Houston Lighting & Power easement east of Red Bluff Road and then along a pipeline corridor parallel to Bay Area Boulevard in the Bayport Industrial District to transport wastewater from the added area described above to the GCWDA plant for treatment.

With this arrangement, the portion of Area B located outside the CLCWA jurisdiction will be served by the GCWDA facility. As a result, the Clear Lake Forest Pump Station and the 16-inch force main will not need additional upgrading to serve ultimate developments within its current service area. In addition, since the GCWDA facility does not have the limitations concerning service to areas within the 100-year floodplain, it can provide services to all future developments in this area without any restrictions.

As in Alternative 1, WCID 75 is encouraged to consider the option of abandoning its WTP and diverting flow to the GCWDA Bayport plant because, in the long run, diversion may prove to be more cost effective than upgrading the existing plant. The elimination of discharge to Taylor Lake will enhance the water quality.

Service Area B

As discussed above, Service Area B of Alternative 2 will not include the area within the cities of Taylor Lake Village and Pasadena between Kirby Road and Taylor Lake. As in Alternative 1, the CLCWA plant will serve as the regional facility for Area B. With a smaller service area, the existing Clear Lake Forest pump station and the 16-inch force main will have reserve capacity for developments with higher population densities than currently envisioned.

Service Area C

Regional Alternative 2 has the same planning elements in Service Area C as those proposed in Alternative 1.

REGIONAL ALTERNATIVE 3

This alternative is also a modification to Regional Alternative 1. As shown in Exhibit 17, the entire study area is divided into three regional service areas (A, B, and C). Ultimately, each of these service areas will be served by a single regional wastewater treatment plant. Important planning elements concerning each regional service area are discussed below.

Service Area A

Planning elements of Service Area A of Alternative 3 are identical to those proposed for Alternative 1. No change is proposed.

Service Area B

Planning elements of Service Area B of Alternative 3 are identical to those proposed for Alternative 1. No change is proposed.

Service Area C

As in Alternative 1, the existing Seabrook WTP and WCID 50 plants are recommended to continue treating wastewater from their respective service areas at the present time. Although if in the future more restrictive treatment level is required by the TWC for facilities discharging into Galveston Bay, the existing Seabrook plant will need upgrading to meet such requirements. Under this alternative, when the existing Seabrook WTP has reached its capacity, requires upgrading, or is damaged by a storm and requires major repairs, the City of Seabrook is recommended to evaluate the feasibility of abandoning the existing plant and diverting the flow to a new North plant to be constructed on the site near Red Bluff Road and Beechcraft Road. As shown in Exhibit 17, the entire City of Seabrook will then be served by a single new plant which has ground elevations approximately 10 to 15 feet higher than the existing plant.

If by that time the WCID 50 WTP has reached its service life, it is recommended that the plant be abandoned and the flow diverted to the Seabrook North plant for treatment. Area C will then be served by a single regional plant operated by a single entity, the City of

Seabrook. The preliminary layout of the proposed regional system discussed above is shown in Exhibit 17.

PROBABLE PROJECT COSTS

Probable construction costs of proposed capital improvements for three regional alternatives shown in Exhibits 15 through 17 are summarized in Tables IV-3 through IV-5. Lift stations and pump stations were sized for flows required under initial (20-year needs) and ultimate phases. In developed areas, trunk sewers were sized for ultimate flows. A comment column in each table shows the primary purpose of individual improvement proposed (e.g., for flow diversion or for future developments). No improvement cost estimates were made for the GCWDA Bayport WTP and the CLCWA WTP. It is assumed that customers to be served by the two regional facilities will pay for their appropriate shares of the WTP construction costs through monthly sewer charges since, in the past, neither of the two regional authorities has levied taxes for WTP construction financing. Probable construction cost estimates for the Seabrook's proposed North plant based on current treatment limits were included primarily for the purpose of comparing the one- and two-plant alternatives. Should more stringent future treatment limits for facilities discharging into Galveston Bay take effect during the planning period, additional costs for improvements to meet the treatment level would apply to both alternatives.

Operation and maintenance (O&M) costs for the proposed improvements along with current sewer charges for each wastewater management agency are summarized in Table IV-6. As these proposed improvements are put into service, the existing sewer rates charged by these regional agencies may have to be adjusted to reflect the higher O&M costs.

EVALUATION OF REGIONAL ALTERNATIVES

Any of the three regional alternatives discussed above should be able to accomplish the goal and objectives established for this project. The best regional wastewater system, however, is not necessarily the one that incurs the least cost. The preferred alternative must be financially, technically, and politically implementable.

Based on oral comments received during the public meeting held on November 5, 1990 and written comments received subsequent to this meeting, the public and various political entities have shown extensive support for the proposed regional plan. Among the three regional alternatives, 1 and 3 seem to have received the most endorsement. Written public comments to the draft report have been included in Appendix II to this report. A summary of these public comments is presented below.

1. The City Council of the City of Taylor Lake Village passed a resolution on December 5, 1990, which states that "the City of Taylor Lake Village wholeheartedly supports the recently completed Regional Wastewater Treatment Plant Study and its conclusions. The City requests that the Texas Water Commission evaluate this study and work with organizations in this area to implement conclusions in the best interest of our citizens."
2. The Mayor of the City of Shoreacres comments in his letter to the GCWDA on November 14, 1990 that "the recommendations concerning the City of Shoreacres wastewater are the same in each of the three alternatives in the report and are consistent with current treatment of Shoreacres wastewater. Therefore, any of the three alternatives are acceptable to Shoreacres."
3. Harris County Municipal Utility District No. 181 indicates that Regional Alternative 1 is the most feasible and economically beneficial alternative to serve the constituents of the District. It urges the acceptance of Regional Alternative No.1 for the permanent regional plan for treatment of wastewater for the Clear Lake area. The District understands that in order for the CLCWA to provide service to Area B under Alternative 1, some legal problems must be resolved first. The District recommends that whatever regional alternative is finally accepted be coordinated with an application to the TWC for the designation of the regional plan under Chapter 13 of the Texas Water Code. (It should be noted that the facility plan to serve the District is the same for Alternative 1 and Alternative 3).
4. The Clear Lake City Water Authority indicates that it conceptually endorses and agrees with the conclusions of the draft report. However, it also points out that the complete implementation of the plan may present several problems for the Authority. A report prepared by the engineer for the CLCWA was submitted which details some of the potential problems associated with providing wastewater service to each of 21 tracts located in Area B. Two main problems discussed in the report are (1) how can the CLCWA plant serve those areas located within the 100-year floodplain and (2) the annexation issue. The report does suggest some solutions to these potential problems. For example, the report states that "if there is any legal advantage to the Authority, it may be possible to sell capacity to the Gulf

Coast Waste Disposal Authority, who in turn could contract with the separate districts and/or with the City of Taylor Lake Village or Pasadena. These approaches could simplify questions of annexations.'

According to these comments, Alternatives 1 and 3 essentially have been endorsed by all entities that commented on the draft report. It should be noted that the only difference between these two alternatives is how the City of Seabrook will provide wastewater service to Area C (i.e., through one or two regional plants). However, the City of Seabrook has not indicated its preference between these two alternatives.

Since the reliability of the existing Seabrook wastewater treatment plant under storm surge conditions is questionable, Alternative 3 may better protect area water quality than Alternative 1. The implementation of this alternative will require higher capital expenditures by the City of Seabrook. However, the costs associated with the construction of a new Seabrook regional plant, the abandonment of the existing treatment facility, and the diversion of flows to the new plant may be partially offset by the savings gained in operation and maintenance of a single facility. Most importantly, this alternative will better protect the Seabrook wastewater facilities from damages resulting from tidal surges frequently occurring in this area. In addition, if more stringent treatment limits are adopted in the future by the TWC for those facilities discharging into Galveston Bay, construction of a new regional plant may be more desirable than upgrading the existing plant and constructing another new plant.

TABLE IV-1 TEXAS WATER COMMISSION SURFACE WATER QUALITY STANDARDS
FOR SEGMENTS IN THE CLEAR LAKE STUDY AREA

Segment	Segment Name	Use	Dissolve Oxygen (mg/l)	Fecal Coliform (#/100 ml)	Chloride (mg/l)	Sulfates (mg/l)	Total Dissolved Solids (mg/l)	pH Range	Temperature (Farenheit) (Not to Exceed)
1113	Armand Bayou Tida	CR/H	4.0	200	-	-	-	6.5-9.0	95
2421	Upper Galveston Ba	CR/H/O	4.0	14	-	-	-	6.5-9.0	95
2425	Clear Lake	CR/H	4.0	200	-	-	-	6.5-9.0	95
2438	Bayport Channel	NCR/H	4.0	200	-	-	-	6.5-9.0	95

Notes :

- CR = Contact Recreation
- H = High Quality Aquatic Habitat
- NCR = Noncontact Recreation
- O = Oyster Waters

Source: Texas Water Commission

TABLE IV-2 PROJECTED ULTIMATE DEVELOPMENT FLOWS
TO CLEAR LAKE FOREST PUMP STATION

Tract	Design Basis	Units	Persons /Unit	Equiv. Population	Average Flow (gpd)	Peak Flow (mgd)	
Clear Lake Forest	807 Lots	1	3.1	2,502	250,170	1.001	
Memory Lane	4 Lots	1	3.1	12	1,240	0.005	
29 Acre Tract	29 Ac	4	3.1	360	35,987	0.144	
Winkler Tract	28 Ac	4	3.1	342	34,195	0.137	
MUD 181	108 Lots	1	3.1	335	33,480	0.134	
Champion	23 Ac	4	3.1	285	28,520	0.114	
H.C. Youth Village & Park	44 Ac Eq	1	3.1	136	13,640	0.055	
Iles Tract	16 Ac	1	3.1	50	4,960	0.020	
Taylor Lake Estates	59 Lots	1	3.1	183	18,290	0.073	
Timber Cove (WCID 75)	235 Lots	1	3.1	729	72,850	0.291	
Pasadena Service Area	100 Ac	1	20	802	80,200	0.321	
So. Taylor Lk Wtr Supply Corp.	12 Ac	1	13	156	15,600	0.062	
19 Acre Tract	20 Ac	1	13	260	26,000	0.104	
32 Acre Tract	32 Ac	25	1.9	1,520	152,000	0.608	
Kaplan Tract	32 Ac	25	1.9	1,520	152,000	0.608	
45 Acre Tract	- -	-	-	1,188	119,000	0.476	
Harbor Point	- -	-	-	109	11,000	0.044	
				Totals	10,489	1,049,132	4.197

Source : David G. Scheffer Engineering Inc.

TABLE IV-3 REGIONAL ALTERNATIVE 1 PROBABLE COST ANALYSIS

Regional Service Area	Implementation Schedule	Description of Improvements	UNIT PRICE (\$)	QUANTITY	PROBABLE COST	Function of Improvements	
A	Wastewater collection pipelines to be constructed by private interests						
B	1990-1995	Rice University Tract Pump Station	L.S.	0.58 mgd	83,500	Rice University Tract Diversion (formerly Lunar Institute)	
	1990-1995	8 -inch Force Main	58	7,300 Lf.	423,400		
	after 2010	Pump Station Upgrade	L.S.	0.62 mgd	27,400		
	1990-1995	8 -inch Sanitary Sewer	50	1,200 Lf.	\$60,000	Service Taylor Lake Village	
	1990-1995	10 -inch Sanitary Sewer	66	5,800 Lf.	382,800	Service Tracts north of WCID75	
	1990-1995	HCWCID 75 Pump Station	L.S.	0.40 mgd	77,300	WCID 75 Diversion	
	1990-1995	6 -inch Force Main	53	1,500 Lf.	79,500		
	1990-1995	12 -inch Sanitary Sewer	70	1,900 Lf.	133,000	Diversion of WCID 75 and Tracts north of WCID 75	
	1990-1995	15 -inch Sanitary Sewer	94	3,200 Lf.	300,800		
	after 2010	Clear Lake Forest Pump Station Upgrade	L.S.	0.90 mgd	253,400		
	Subtotal Area B					\$1,821,100	
	Engineering and Contingencies (25%)					455,300	
	Project Total Area B					\$2,276,400	
	C	after 2010	12 -inch Sanitary Sewer	70	3,200 Lf.	224,000	Seabrook Diversion and Service Lines to Proposed North Seabrook WTP
after 2010		24 -inch Sanitary Sewer	158	6,400 Lf.	1,011,200		
after 2010		30 -inch Sanitary Sewer	183	2,400 Lf.	439,200		
after 2010		Bayport Boulevard Lift Station	L.S.	0.75 mgd	89,400		
after 2010		HCWCID 50 Pump Station	L.S.	1.8 mgd	125,900	WCID 50 Diversion	
after 2010		10 -inch Force Main	62	4,000 Lf.	248,000		
after 2010		21 -inch Sanitary Sewer	91	5,600 Lf.	509,600	Diversion of WCID 50 and Seabrook to Proposed Seabrook North WTP	
after 2010		24 -inch Sanitary Sewer	158	3,600 Lf.	568,800		
after 2010		30 -inch Sanitary Sewer	183	1,400 Lf.	256,200		
after 2010		Todville Rd. Lift Station	L.S.	3.5 mgd	184,900		
after 2010		Proposed Seabrook North WTP	L.S.	3.15 mgd	3,938,000		
Subtotal Area C					\$7,595,200		
Engineering and Contingencies (25%)					1,898,800		
Project Total Area C					\$9,494,000		
PROJECT TOTAL REGIONAL ALTERNATIVE 1					\$11,770,400		

TABLE IV-4 REGIONAL ALTERNATIVE 2 PROBABLE COST ANALYSIS

Regional Service Area	Implementation Schedule	Description of Improvements	UNIT PRICE (\$)	QUANTITY	PROBABLE COST	Function of Improvements
A	Wastewater collection pipelines to be constructed by private interests					
B	1990-1995	8 -inch Force Main	58	7,300 Lf.	423,400	Rice University Tract Diversion
	1990-1995	Rice University Tract Pump Station	L.S.	0.58 mgd	83,500	
	after 2010	Pump Station Upgrade	L.S.	0.62 mgd	27,400	
	1990-1995	8 -inch Sanitary Sewer	50	1,200 Lf.	\$60,000	Service Taylor Lake Village
	1990-1995	10 -inch Sanitary Sewer	66	6,900 Lf.	448,800	
	1990-1995	6 -inch Force Main	53	1,500 Lf.	79,500	WCID 75 Diversion
	1990-1995	HCWCID 75 Pump Station	L.S.	0.40 mgd	77,300	
	1990-1995	10 -inch Sanitary Sewer	66	2,600 Lf.	171,600	Service Tracts north of WCID 75
	1990-1995	12 -inch Sanitary Sewer	70	300 Lf.	21,000	Diversion of WCID 75 and Tracts north of WCID 75
	1990-1995	Kirby Road Pump Station	L.S.	0.53 mgd	81,800	Diversion of WCID 75, Taylor Lake Village, and
	1990-1995	12 -inch Force Main	67	10,900 Lf.	730,300	Tracts north of WCID 75
	1990-1995	18 -inch Sanitary Sewer	107	1,900 Lf.	203,300	
	after 2010	Pump Station Upgrade	L.S.	1.57 mgd	41,600	
		Subtotal Area B			\$2,449,500	
		Engineering and Contingencies (25%)			612,400	
		Project Total Area B			\$3,061,900	
C	after 2010	12 -inch Sanitary Sewer	70	3,200 Lf.	224,000	Seabrook Diversion and Service Lines
	after 2010	24 -inch Sanitary Sewer	158	6,400 Lf.	1,011,200	to Proposed North
	after 2010	30 -inch Sanitary Sewer	183	2,400 Lf.	439,200	Seabrook WTP
	after 2010	Bayport Boulevard Lift Station	L.S.	0.75 mgd	89,400	
	after 2010	HCWCID 50 Pump Station	L.S.	1.8 mgd	125,900	WCID 50 Diversion
	after 2010	10 -inch Force Main	62	4,000 Lf.	248,000	
	after 2010	21 -inch Sanitary Sewer	91	5,600 Lf.	509,600	Diversion of WCID 50 and
	after 2010	24 -inch Sanitary Sewer	158	3,600 Lf.	568,800	Seabrook to Proposed
	after 2010	30 -inch Sanitary Sewer	183	1,400 Lf.	256,200	Seabrook North WTP
	after 2010	Todville Rd. Lift Station	L.S.	3.5 mgd	184,900	
	after 2010	Proposed Seabrook North WTP	L.S.	3.15 mgd	3,938,000	
		Subtotal Area C			\$7,595,200	
		Engineering and Contingencies (25%)			1,896,800	
		Project Total Area C			\$9,494,000	
		PROJECT TOTAL REGIONAL ALTERNATIVE 2			\$12,555,900	

TABLE IV-5 - REGIONAL ALTERNATIVE 3 PROBABLE COST ANALYSIS

Regional Service Area	Implementation Schedule	Description of Improvements	UNIT PRICE (\$)	QUANTITY	PROBABLE COST	Function of Improvements
A	Wastewater collection pipelines to be constructed by private interests					
B	1990-1995	Rice University Tract Pump Station	L.S.	0.58 mgd	83,500	Rice University Tract Diversion (formerly Lunar Institute)
	1990-1995	8 -inch Force Main	58	7,300 lf.	423,400	
	after 2010	Pump Station Upgrade	L.S.	0.62 mgd	27,400	
	1990-1995	8 -inch Sanitary Sewer	50	1,200 lf.	\$60,000	Service Taylor Lake Village
	1990-1995	10 -inch Sanitary Sewer	66	5,800 lf.	382,800	Service Tracts north of WCID75
	1990-1995	HCWCID 75 Pump Station	L.S.	0.40 mgd	77,300	WCID 75 Diversion
	1990-1995	6 -inch Force Main	53	1,500 lf.	79,500	
	1990-1995	12 -inch Sanitary Sewer	70	1,900 lf.	133,000	Diversion of WCID 75 and Tracts north of WCID 75
	1990-1995	15 -inch Sanitary Sewer	94	3,200 lf.	300,800	
	after 2010	Clear Lake Forest Pump Station Upgrade	L.S.	0.90 mgd	253,400	
		Subtotal Area B			\$1,821,100	
		Engineering and Contingencies (25%)			455,300	
		Project Total Area B			\$2,276,400	
C	after 2010	10 -inch Force Main	62	7,200 lf.	446,400	WCID 75 Diversion
	after 2010	HCWCID 50 Pump Station	L.S.	1.8 mgd	125,900	
	after 2010	30 -inch Sanitary Sewer	183	4,400 lf.	805,200	WCID 75 Diversion and Seabrook Service Lines to Proposed Seabrook North WTP
	after 2010	36 -inch Sanitary Sewer	253	2,500 lf.	632,500	
	after 2010	Proposed Seabrook North WTP	L.S.	3.75 mgd	4,690,000	
	after 2010	24 -inch Sanitary Sewer	158	5,000 lf.	790,000	Seabrook Diversion and Service Lines to Proposed Seabrook North WTP
	after 2010	30 -inch Sanitary Sewer	183	1,400 lf.	256,200	
	after 2010	12 -inch Force Main	67	7,000 lf.	469,000	Proposed Seabrook North WTP
	after 2010	Seabrook WTP Pump Station	L.S.	2.76 mgd	159,200	
		Subtotal Area C			\$8,374,400	
		Engineering and Contingencies (25%)			2,093,600	
		Project Total Area C			\$10,468,000	
PROJECT TOTAL REGIONAL ALTERNATIVE 3					\$12,744,400	

TABLE IV-6 Existing Sewer Rates and Projected Pump Station O & M Costs

<u>PUMP STATION</u>	<u>PROJECTED ANNUAL O & M COSTS</u>
Rice University Tract Pump Station	\$9,600
HCWCID 75 Pump Station	7,500
HCWCID 50 Pump Station	11,200
Bayport Boulevard Lift Station	8,200
Todville Road Lift Station	11,600
Kirby Road Lift Station	9,700
Seabrook WTP Pump Station	15,000

<u>AGENCY</u>	<u>EXISTING SEWER RATE</u>
Clear Lake City Water Authority	\$0.73 / 1,000 gallons
GCWDA - Bayport Facility	\$0.61 / 1,000 gallons
City of Seabrook	\$12.80 / 1,000 gallons (first 4,000 gallons) \$1.90 / 1000 gallons (4,000 - 12,000 gallons)

Perhaps the most difficult and controversial part of a wastewater regional plan is the determination of how the implementation of the plan should be financed and how it should be managed. Without workable answers to these questions, any capital development program obviously remains only a plan. In analyzing the options available for financing proposed improvements presented in this study, several factors must be considered. Ability, or inability, to pay may significantly limit user charges as a potential revenue source, thus limiting the participation in loan or grant programs. Existing municipal and utility service areas, facilities, and financial commitments also influence the choice of financing and management structures and on which procedures appear most reasonable for future development. This section of the report examines some of funding requirements and the federal and state financing options which may be available to implement the proposed regional wastewater plan in the Study area.

FEDERAL PROGRAMS

Clean Water Act Construction Grants Program

Historically, the most important program assisting in the financing of wastewater treatment facilities has been the federal construction grants program administered by the EPA. This program has been the major financial participant in new wastewater treatment plant development throughout the country since its inception in 1972. As an example, the construction of the CLCWA WTP was originally financed through this program. However, in recent years lack of available funding has essentially limited the program's participation to assistance in completion of projects that are currently under development. The grants program is being phased out and replaced by a state revolving loan fund program discussed below in the state program section. Initial seed money to establish the state loan program has come from federal capitalization grants. Federal participation is expected to cease after 1991 because it should be fully capitalized by then and the SRF loan program will be completely administered and supported by the state.

Housing and Urban Development Community Development Block Grants

The Department of Housing and Urban Development (HUD) has two broad categories of Community Development Block Grants - formula grants, which are allocated directly to larger cities (over 50,000 population) and urban counties (over 200,000 population); and project grants for smaller cities which, in most cases (including Texas), are administered by the states. In the case of Texas, these grant funds are administered by the Texas Department of Commerce. The objectives of both these programs are very broad, as are the types of projects they support. Their purpose is to enhance the living environment and economic opportunities of both low and moderate income persons. Because of this, these grant funds seldom go to single major projects but most often are allotted to many relatively small projects which are unable to qualify for other types of funding.

STATE PROGRAMS

The State Water Pollution Control Revolving Fund (SRF)

The State Revolving Fund is a perpetual fund through which the TWDB provides low interest loans to Texas communities for the construction of wastewater treatment works. Eligible projects include construction of new treatment plants, interceptor sewers, and repairs to existing collection systems. In addition to construction funding, loans also can include funds for planning and design. As noted above, the SRF program replaces the federal construction grants program and is managed by the state with minimal federal oversight but it must meet a full set of federal guidelines. The FY 1990 interest rates were 5.5 percent and the maximum term of SRF loans is 20 years after project completion.

In order to apply for assistance, an entity must be an interstate agency, city, town, county, district, river authority, association, or other public body created by or pursuant to state law which has the authority to own and operate wastewater treatment works. The entity also must be or have applied to become a designated waste management agency before the Texas Water Commission, pursuant to federal requirements. Among other requirements the applicant additionally must satisfy the following:

-
1. Have a cost-effective, eligible project which is included on the Intended Use Plan List.
 2. Prepare a water conservation plan and SRF engineering report.
 3. Document the existence of a dedicated source of funds for repayment.
 4. Implement a user charge system and demonstrate that it has the financial and managerial capability.
 5. Obtain an environmental determination in compliance with the National Environmental Policy Act.

Recent changes to the SRF legislation allow for a reserve fund to be established from SRF repayments for loans to eligible applicants which qualify as hardship cases. In evaluating hardship, the TWDB considers severity of the public health problem, alternative funding sources imposing a hardship on the community, median household income, and area unemployment. Should an entity qualify, certain priority ranking and project rating requirements of the program can be waived, as well as completion of the SRF engineering plan.

Texas Community Development Program

The funds the Texas Department of Commerce (TDOC) receives from the HUD Community Development Block Grant Program (see above) go to fund the Texas Community Development Program. There are three major funds under the program: the Community Development Project Fund, the Area Revitalization Fund, and the Emergency/Urgent Need Fund.

The Community Development Project Fund allocates funds among the state's 24 planning regions to cities and counties for public facilities/services and housing assistance projects. Water and sewer construction projects are eligible under this program but, as with other financial assistance programs, operating and maintenance expenses are not. The Area Revitalization Fund provides statewide competition for projects to cities and counties who have not applied under the Community Development Project Fund Program. The

Emergency/Urgent Need Fund is established to respond to natural disasters and to projects that pose a threat to the immediate health and safety of the local residents.

TWDB Financial Assistance and Water Bond Insurance Programs

Under the Texas Water Code, the TWDB administers programs of financial assistance for projects involving water conservation, water development, and water quality enhancement, as well as flood control and drainage. These programs are for loans and loan insurance and do not currently include construction grants. Water quality enhancement projects can cover wastewater projects. Matching grants are available for planning and engineering design of these facilities. These programs are separate from the SRF program which was initiated at the federal level.

The TWDB's financial assistance and bond insurance programs are available to any political subdivision of the State. The Board has considerable latitude regarding the terms and conditions of loans made, including interest deferral or the capitalization of interest and can make loans for durations of 50 years. The TWDB can acquire, lease, construct, or reconstruct projects with funds from the so-called state participation account and thus own up to 50 percent of a project. In turn, the state can sell, transfer, or lease its ownership to an eligible applicant. This can be undertaken so long as the TWDB can reasonably expect that the state will recover its investment in the facility.

FUNDING REQUIREMENTS

Because the ultimate use of funds will often influence the method best suited for securing the funding, the financial needs of the typical wastewater service should be examined by use category. In this way, a financial program can be established which may comprise a variety of financing sources, each designed to accommodate a separate funding need.

Funding Operations and Maintenance Costs

The costs of operating and maintaining a regional wastewater system are daily costs that require a continuous flow of funds. The anticipated operations and maintenance

(O&M) expenses for a fiscal period are generally budgeted prior to the beginning of the period. These budgeted funding needs are then converted to per-unit costs for collection purposes.

If the O&M expenses are to be financed through user charges, the budgeted figures can be converted into monthly charges per gallon of water/wastewater used or per service connection. Revenues derived from these charges are then used to finance the O&M expenses incurred during the period. Obviously, the ability of this financing method to accurately generate needed funds is dependent on the accurate projection of O&M expenses, volume of water and/or wastewater, and number of active connections during the budget period.

If O&M expenses are to be subsidized with tax revenues, the budgeted O&M expenses need to be added to other financing needs to be covered by the specific tax involved. While tax generated revenue is not considered to be as fair and equitable as user charges in paying for utility operations, taxes are generally a more reliable and predictable form of revenue generation.

Debt financing is almost never used to finance O&M expenses. In fact most bond covenants will specifically prohibit bond funds from being used for O&M expenses.

Capital Funding of New Regional Systems

The major funding need of a new system is for financing design and construction of the facilities. These new facilities may be an entirely new facility or expansion to an existing system. Some characteristics that are common to all facility financing will tend to influence the funding alternatives to be considered. First, during construction, there is generally a requirement for a relatively large capital funding commitment over a relatively short time period. Second, the amount of funds required for a specific project can usually be quite accurately estimated before a financing commitment is made. Third, most new facilities will be useful and productive over an extended time period far beyond the initial funding time frame.

Because of these common characteristics, most financing of new facilities will involve some form of debt. By issuing debt, the utility can obtain the relatively large initial

investment required for construction and amortize repayment of the debt over the estimated useful life of the system. In this way, the repayment of the debt takes the form of annual payments similar to the annual depreciation expense of the newly financed facility. Those entering the system after it is built are required to share its initial cost in the form of amortized debt service as part of their annual user fees.

While grants may become available to help fund a portion of the capital costs, some of these costs will likely require local debt financing. It follows that most, if not all, of the customers' affordable monthly charge will need to be allotted to paying O&M costs, little, if any, user charge revenue is left with which to amortize the local share of the capital costs.

Justification for using general tax revenue in support of capital funding of wastewater facilities can be made based on general public benefits received. The potential pollution and environmental damage caused by poorly constructed and operated small wastewater treatment plants have been well documented in the past. While a case can be made that those who create the problem should pay to correct it, if they cannot afford the cost and no correction is undertaken, the problem extends far beyond the individual residence discharging the wastewater.

An alternative to general tax support to fund necessary facility expansion is to require developers to pay for the necessary improvements. This has the effect of having the buyer of the property pay, as the developer's costs are passed on to the buyer in terms of a higher purchase price.

Capital Funds for Repair and Replacement of Existing Systems

Probably the most ignored or abused funding requirements of wastewater systems are those required for facility repair and replacement (R&R). Wastewater systems often are in need of facility replacement or repair that goes unfulfilled due to lack of required funding. This type of financial oversight generally results in a system which operates ineffectively.

Financing system repair and replacement needs generally differs from new facility financing. While the funding needs for R&R can be significant, especially as a system ages, R&R funding is not as predictable or preplanned as funding new or expanded facilities.

Therefore, R&R financing usually makes use of a reserve fund created by regular periodic contributions until the fund reaches some preset balance. Thereafter, contributions are made only as necessary to retain the preset balance.

CONCLUSIONS

1. The planning area encompasses approximately 21,000 acres, or 33 square miles, and includes five cities (Seabrook, El Lago, Taylor Lake Village, Shoreacres, and Pasadena), three municipal utility districts, and two regional authorities (Gulf Coast Waste Disposal Authority and Clear Lake City Water Authority).
2. Populations in the study area are projected to grow from 19,588 in 1990 to 25,506 in 2000 and 29,304 in 2010. The compounded annual growth rate for the first ten years is 2.7 percent, slightly higher than the 2.4 percent occurred between 1980 and 1990. The growth rate is projected to slow to 1.4 percent per year between the years 2000 and 2010.
3. Wastewater flows generated from the study area have been projected to increase from 1.979 mgd in 1990 to 2.573 mgd in 2000 and 2.976 mgd in 2010 in terms of dry-weather average flow. Annual average flows are projected to grow from 2.675 mgd in 1990 to 3.477 mgd in 2000 and 4.024 mgd in 2010.
4. At the present time, seven municipal and 12 industrial wastewater discharge permits have been issued by the Texas Water Commission within the study area. Three of the municipal permit holders (i.e., the City of Pasadena, Lexel Establishment, and L.H. Homan) have not constructed their wastewater treatment facilities. Ten of the industrial permits are for discharges of uncontaminated stormwater only.
5. Three regional wastewater facility alternatives were developed for the study area. All three alternatives propose to divide the entire project area into three regional service areas. Ultimately, each of these service areas will be served by one or two regional wastewater treatment plants. The existing 15.8-mgd GCWDA Bayport wastewater treatment plant (WTP) and the 6.75-mgd (to be expanded to 9.0 mgd) CLCWA WTP have been considered as the regional facilities in two of the three service areas. In the third service area, the existing 2.5-mgd Seabrook WTP and the 540,000-gpd HCWCID 50 WTP will continue to provide the needed wastewater service until their capacities are reached. At that time, a new treatment plant to be constructed by the City of Seabrook will serve as the regional facility for the area.

-
6. Several federal and state financial assistance programs are currently available to assist entities in the study area to construct the proposed regional system improvements. Financing for new developments in the area is likely to be borne by the developers.

RECOMMENDATIONS

1. The proposed regional wastewater plan is believed to be fair, realistic, and prospective. For this reason, all entities in the project area are encouraged to participate in the plan so that the proposed planning elements can be successfully implemented. It is also recommended that the Texas Water Commission adopt and designate this regional wastewater facility plan for the Clear Lake Area under Chapter 13 of the Texas Water Code.
2. All three regional alternatives should be able to accomplish the goal and objectives established for this project. However, based on comments on the draft report, Alternatives 1 and Alternative 3 received the most support from the public.
3. It is recommended that the City of Seabrook evaluate the Regional Alternative 3 proposed in this study and consider the feasibility of incorporating the planning elements described in this plan into City's existing wastewater master plan.
4. All entities in the study area are encouraged to either continue implementing their TWDB approved water conservation programs and drought contingency plans or develop and adopt an effective program as presented in Appendix I to this report.

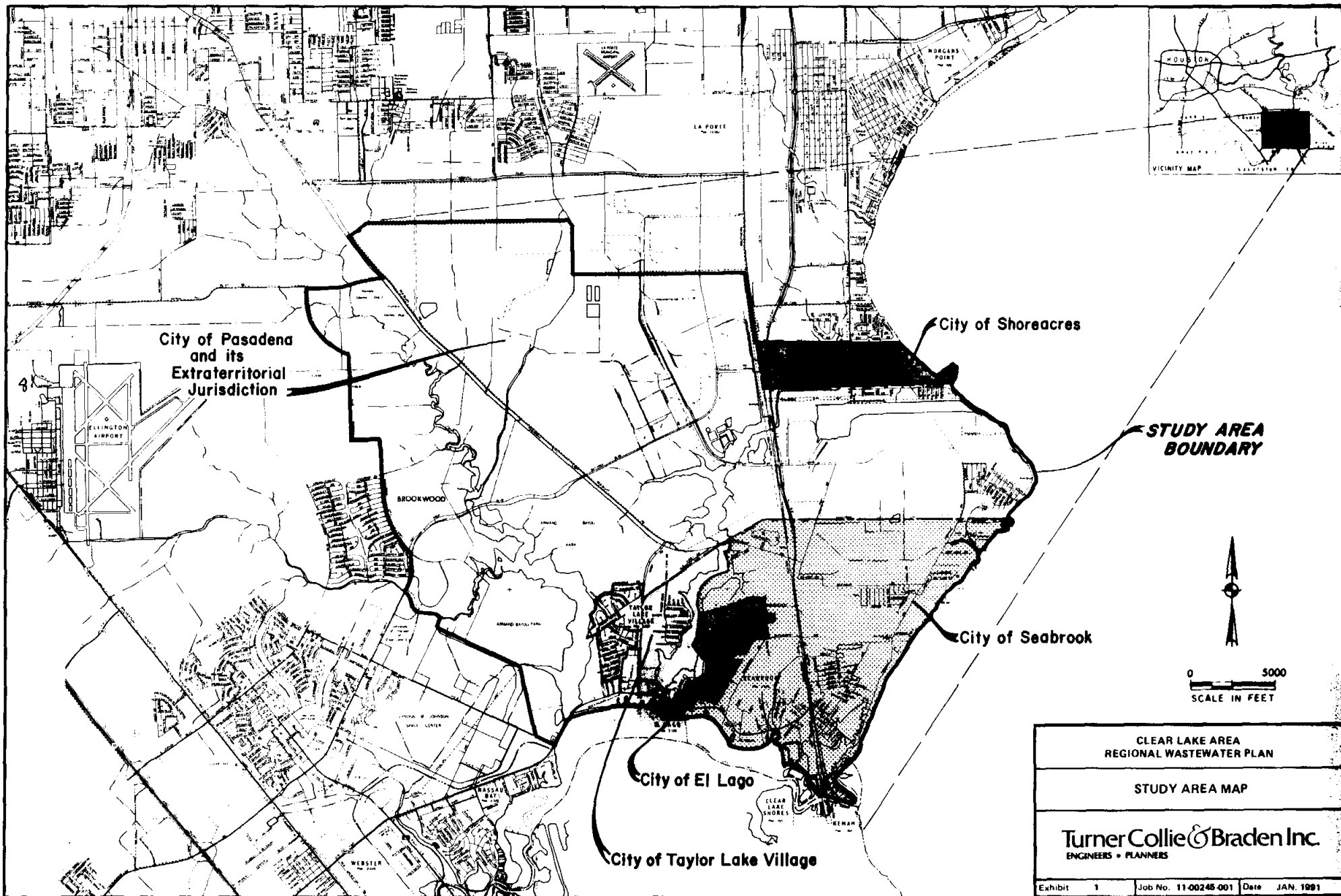

CLEAR LAKE AREA REGIONAL WASTEWATER PLAN		
STUDY AREA MAP		
Turner Collie & Braden Inc. ENGINEERS • PLANNERS		
Exhibit	1	Job No. 11-00245-001
		Date JAN. 1991

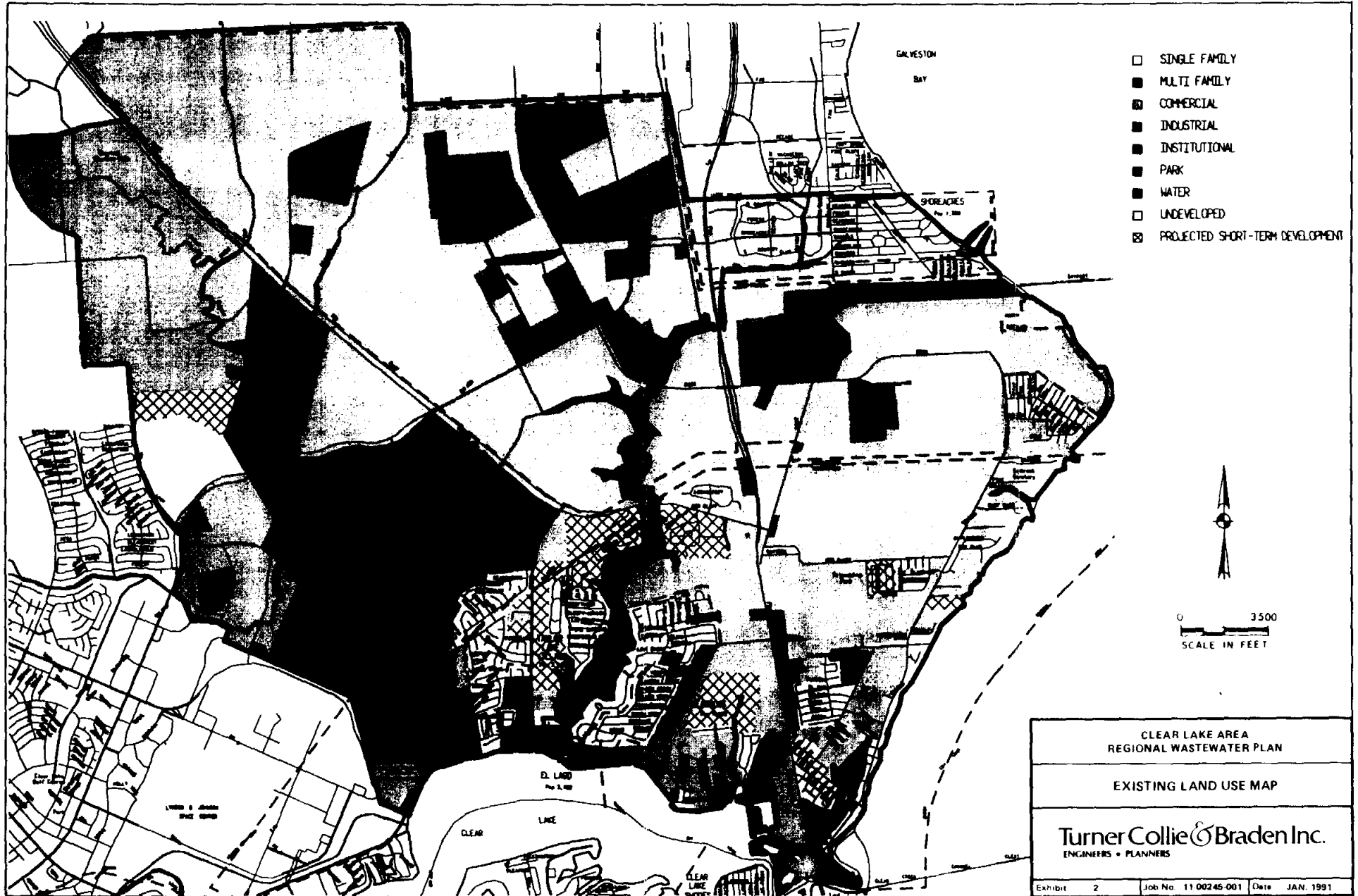

- SINGLE FAMILY
- MULTI FAMILY
- COMMERCIAL
- INDUSTRIAL
- INSTITUTIONAL
- PARK
- WATER
- UNDEVELOPED
- PROJECTED SHORT-TERM DEVELOPMENT



CLEAR LAKE AREA
REGIONAL WASTEWATER PLAN

EXISTING LAND USE MAP

Turner Collie & Braden Inc.
ENGINEERS • PLANNERS

Exhibit 2 Job No. 11.00245-001 Date JAN. 1991

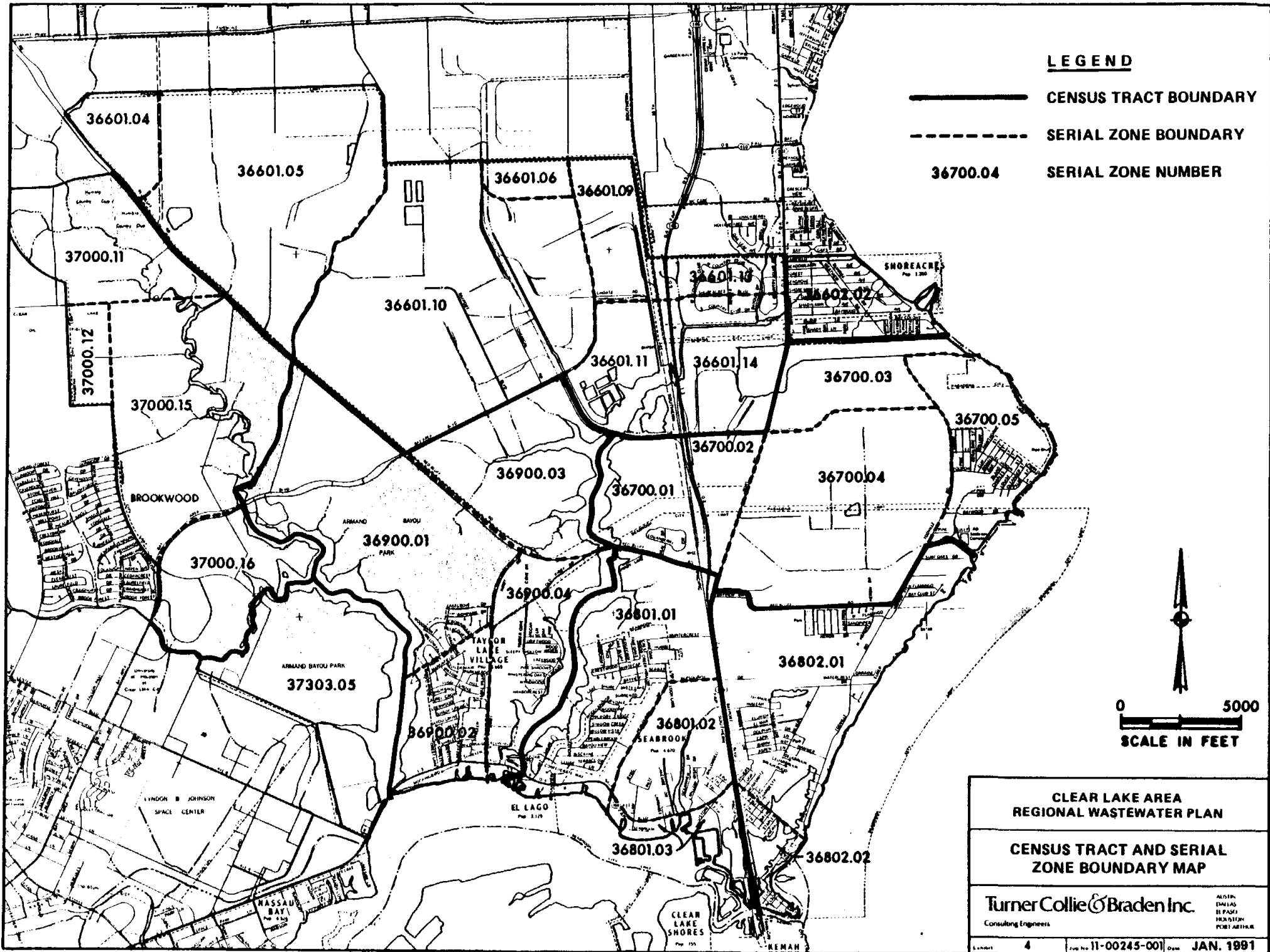

**CLEAR LAKE AREA
REGIONAL WASTEWATER PLAN**

**CENSUS TRACT AND SERIAL
ZONE BOUNDARY MAP**

Turner Collie & Braden Inc.
Consulting Engineers

ALBANY
DALLAS
EL PASO
HOUSTON
FORT WORTH

4 [Job No. 11-00245-001] Date **JAN. 1991**

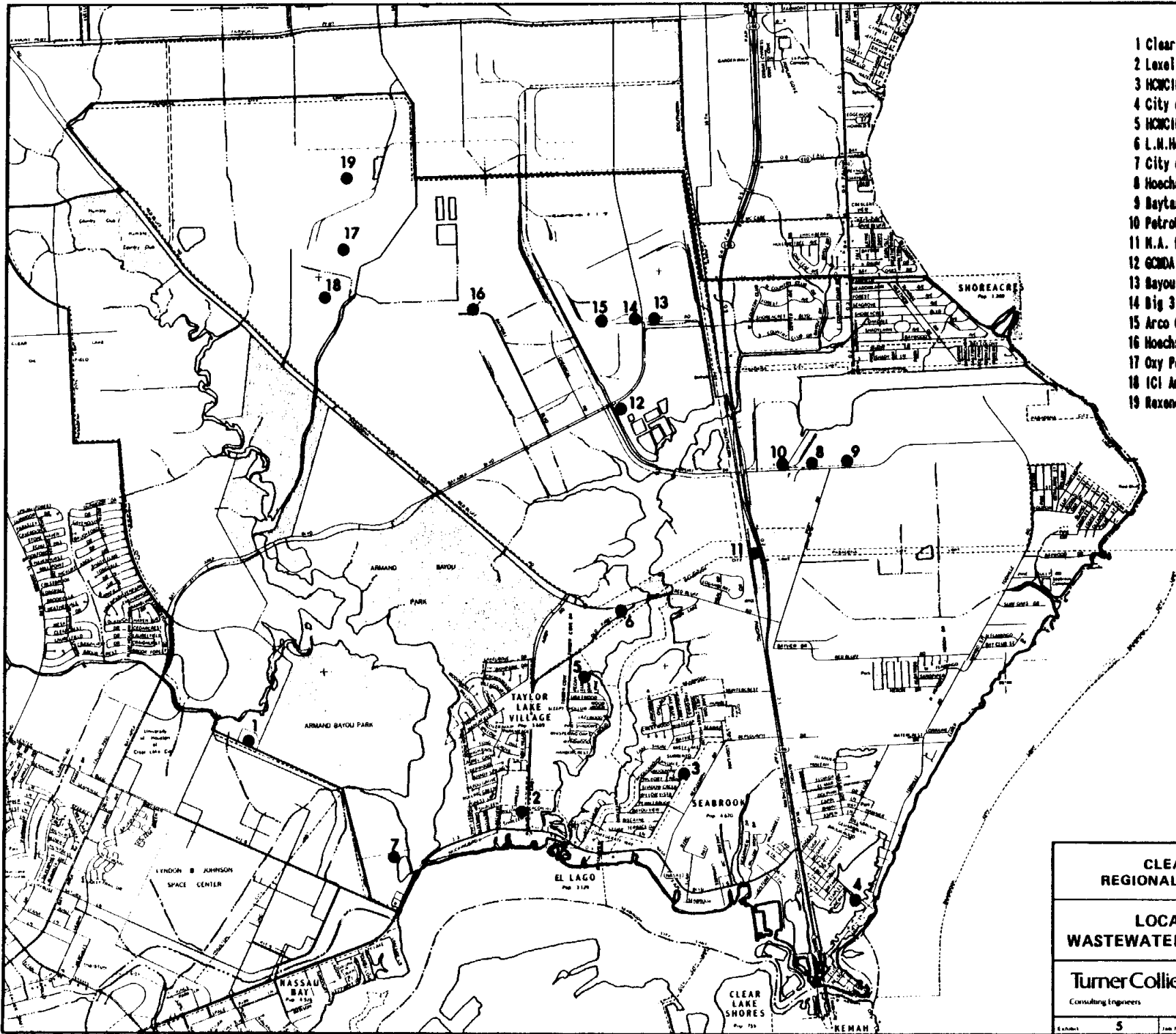

- 1 Clear Lake Water Authority 10539-001
- 2 Lexel Establishment 12545-001
- 3 HWCID No.50 10243-001
- 4 City of Seabrook 10671-001
- 5 HWCID No.75 10106-001
- 6 L.N.Homan 13382-001
- 7 City of Pasadena 10053-008
- 8 Hoechst Celanese Chemical 02590-001
- 9 Baytank (Houston) Inc. 02547-001
- 10 Petrobrinit Terminal 02110-001
- 11 N.A. Hanna Company 01028-001
- 12 GCMDA Bayport Central 01054-001
- 13 Bayou Cogeneration Plant 02915-001
- 14 Big 3 Industrial Gas Inc. 02916-001
- 15 Arco Chemical Company 02756-001
- 16 Hoechst Celanese Chemical 02571-001
- 17 Oxy Petrochemicals, Inc. 03029-001
- 18 ICI Americas, Inc. 02654-001
- 19 Rexone Products Company 02600-001

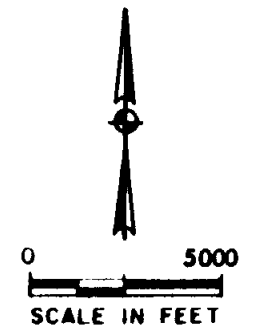

CLEAR LAKE AREA REGIONAL WASTEWATER PLAN	
LOCATIONS OF TWC WASTEWATER DISCHARGE PERMITS	
TurnerCollie & Braden Inc.	
Consulting Engineers	
EX-1011 5	JOB No 11-00245-001 DATE JAN. 1991

MAPS
 DRAWN BY
 EL PASO
 MEXICAN
 PORT AUTHORITY

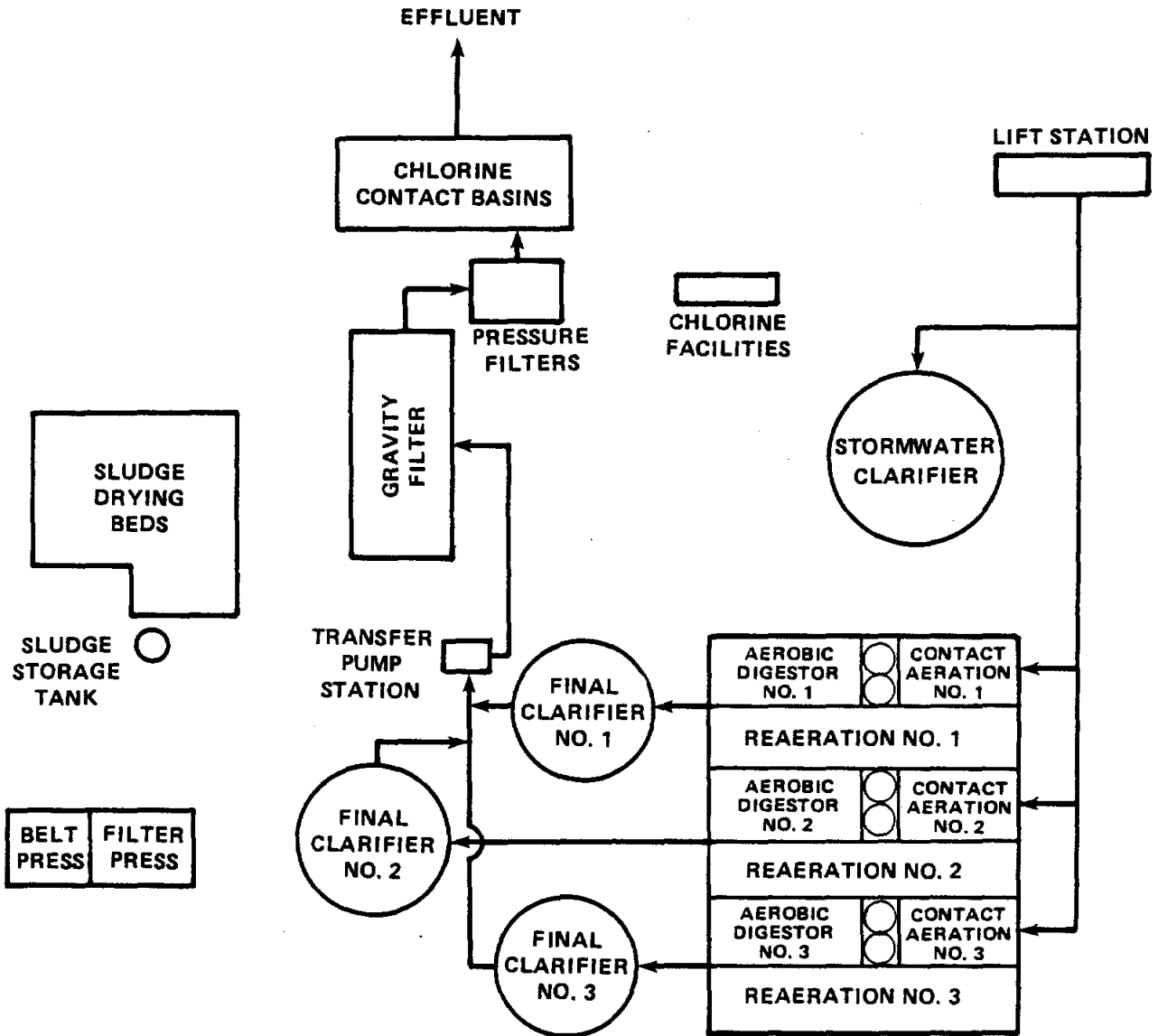

CLEAR LAKE AREA
REGIONAL WASTEWATER PLAN

CLCWA
WASTEWATER TREATMENT PLANT
FLOW DIAGRAM

Turner Collie & Braden Inc.
ENGINEERS • PLANNERS

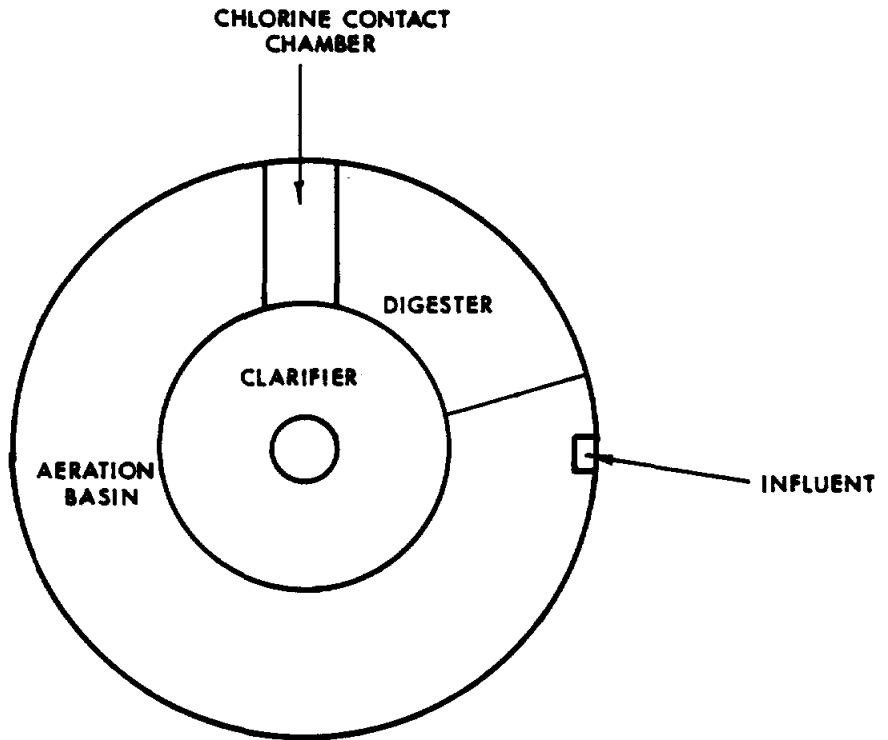

CLEAR LAKE AREA
REGIONAL WASTEWATER PLAN

HARRIS CO. WCID 75
WASTEWATER TREATMENT PLANT
FLOW DIAGRAM

Turner Collie & Braden Inc.
ENGINEERS • PLANNERS

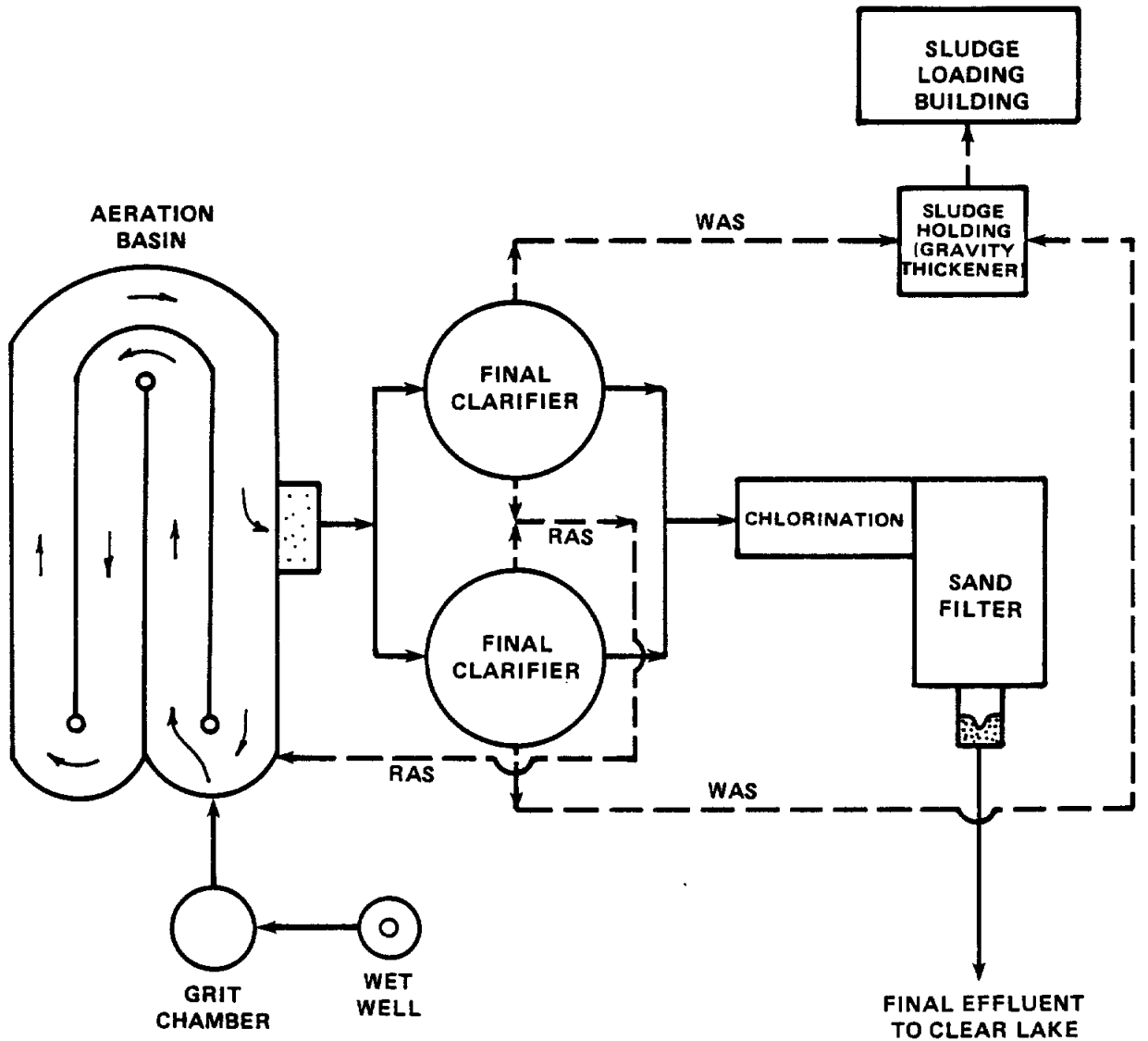

KEY

- WASTEWATER
- - - - - SLUDGE
- RAS RETURN ACTIVATED SLUDGE
- WAS WASTE ACTIVATED SLUDGE

CLEAR LAKE AREA
REGIONAL WASTEWATER PLAN

HARRIS CO. WCID 50
WASTEWATER TREATMENT PLANT
FLOW DIAGRAM

Turner Collie & Braden Inc.
ENGINEERS • PLANNERS

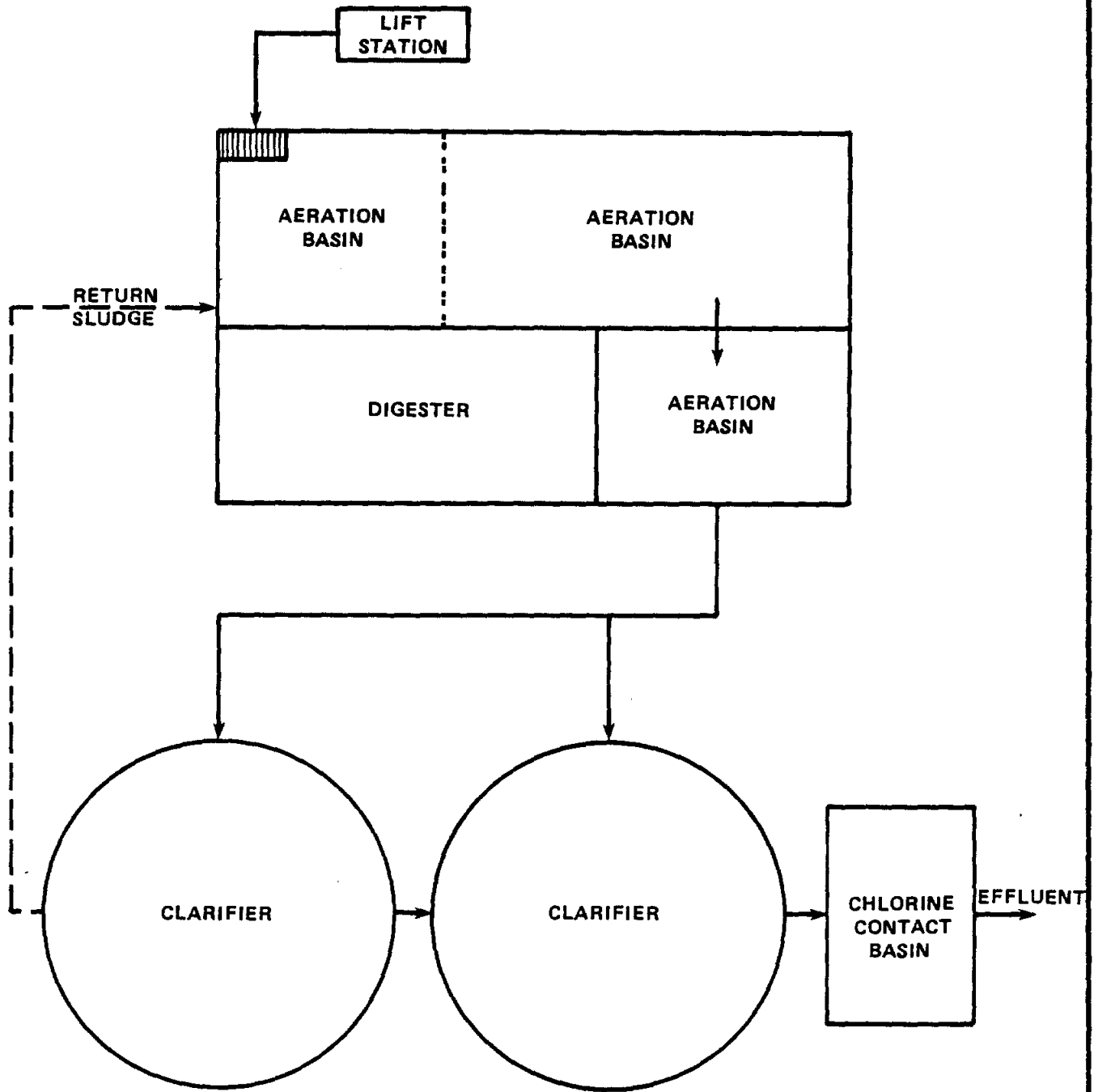

KEY

- WASTEWATER
- - - SLUDGE

CLEAR LAKE AREA REGIONAL WASTEWATER PLAN			
CITY OF SEABROOK WASTEWATER TREATMENT PLANT FLOW DIAGRAM			
Turner Collie & Braden Inc. ENGINEERS • PLANNERS			
Exhibit	10	Job No. 11-00245-001	Date JAN. 1991

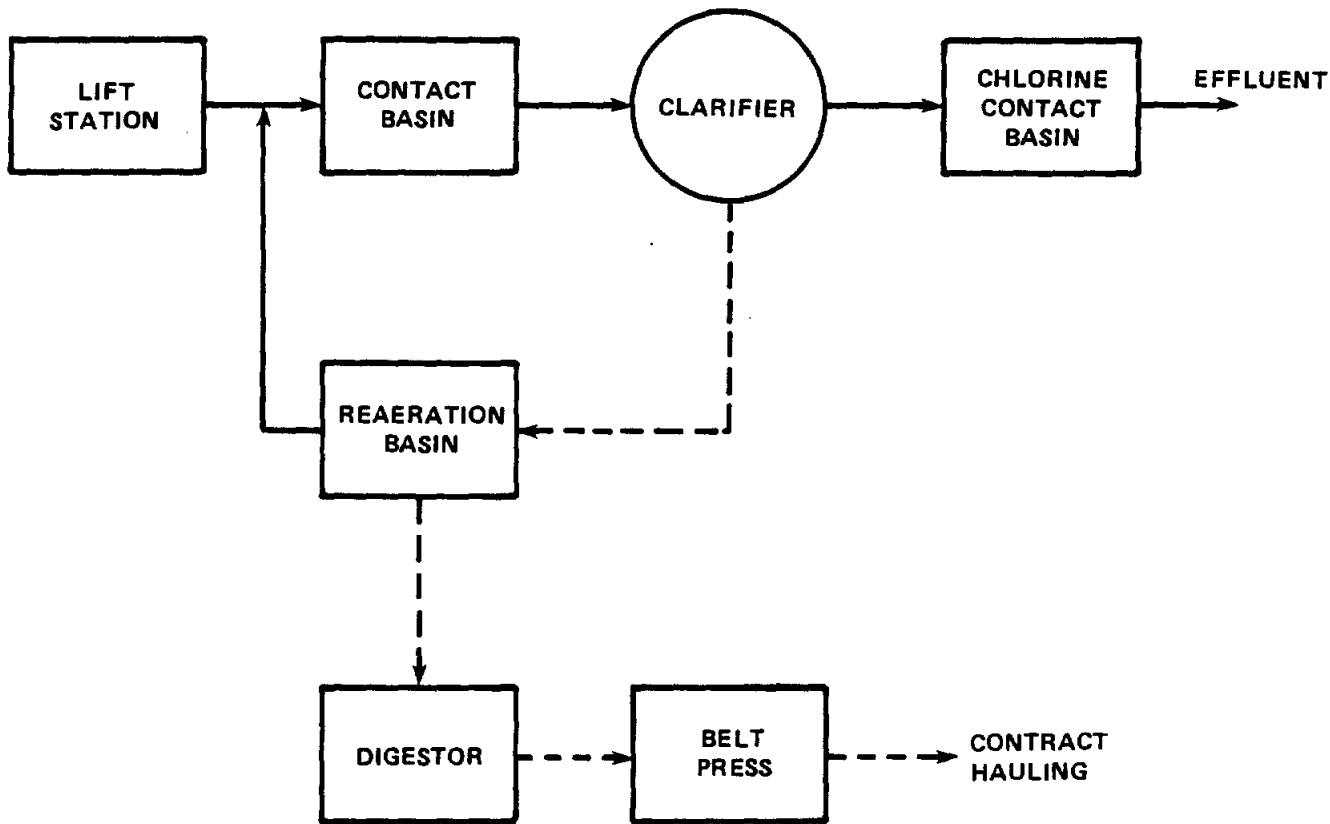

KEY

- WASTEWATER
- - - - SLUDGE

CLEAR LAKE AREA
REGIONAL WASTEWATER PLAN

LEXEL ESTABLISHMENT
WASTEWATER TREATMENT PLANT
FLOW DIAGRAM

Turner Collie & Braden Inc.
ENGINEERS • PLANNERS

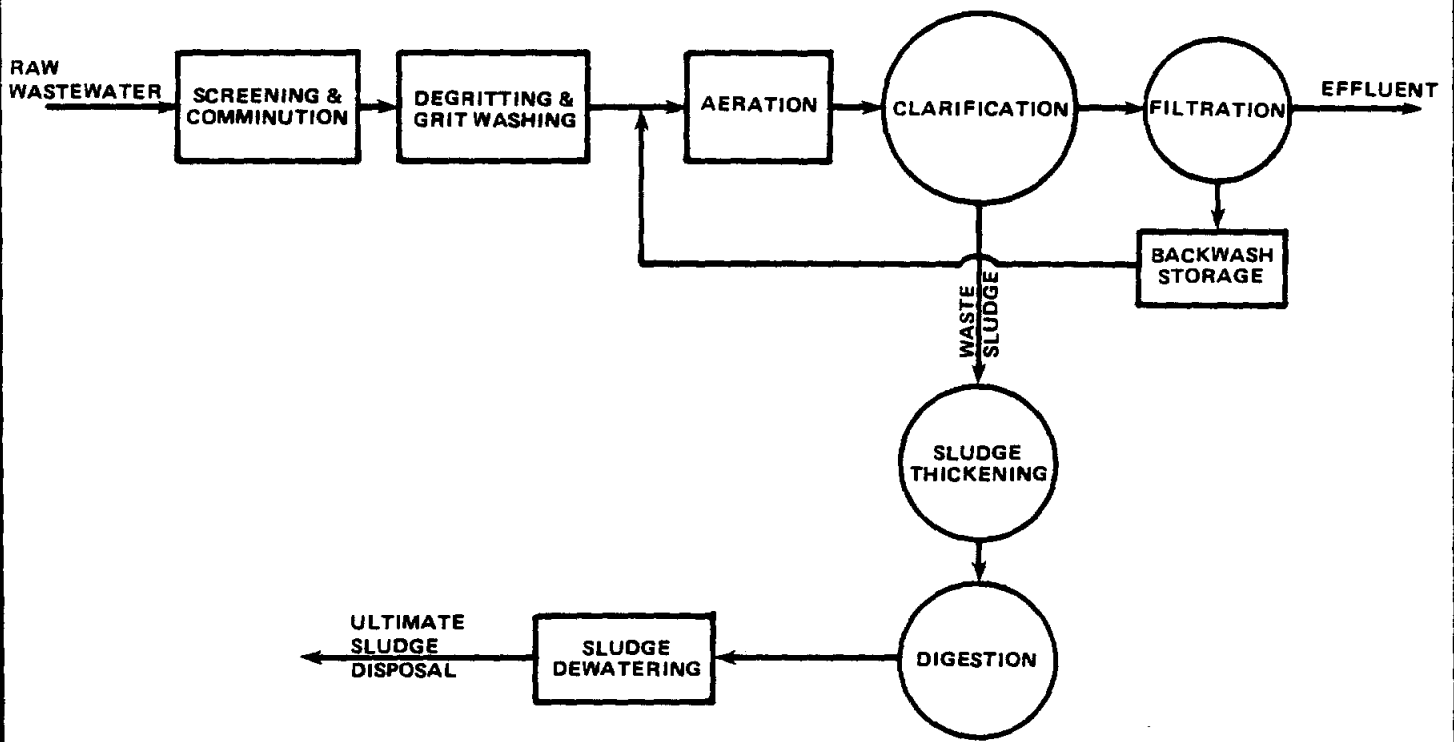

CLEAR LAKE AREA
REGIONAL WASTEWATER PLAN

L. H. HOMAN (LAKE ESTATES)
WASTEWATER TREATMENT PLANT
FLOW DIAGRAM

Turner Collie & Braden Inc.
ENGINEERS • PLANNERS

BIO-SAN (40 CUSTOMERS)
INDUSTRIAL & DOMESTIC
WASTE

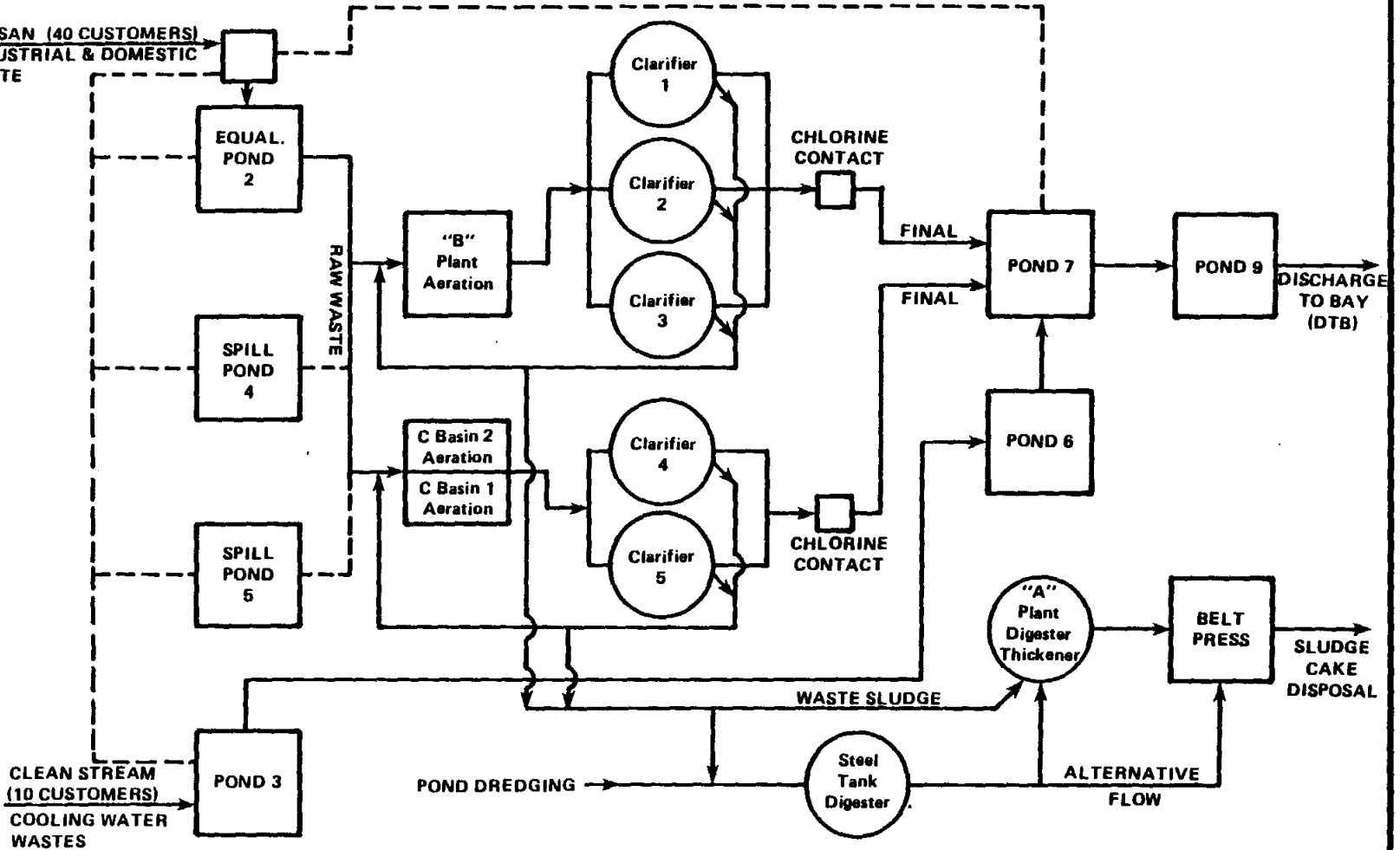

CLEAR LAKE AREA
REGIONAL WASTEWATER PLAN
GCWDA BAYPORT
WASTEWATER TREATMENT PLANT
FLOW DIAGRAM

Turner Collie & Braden Inc.
ENGINEERS • PLANNERS

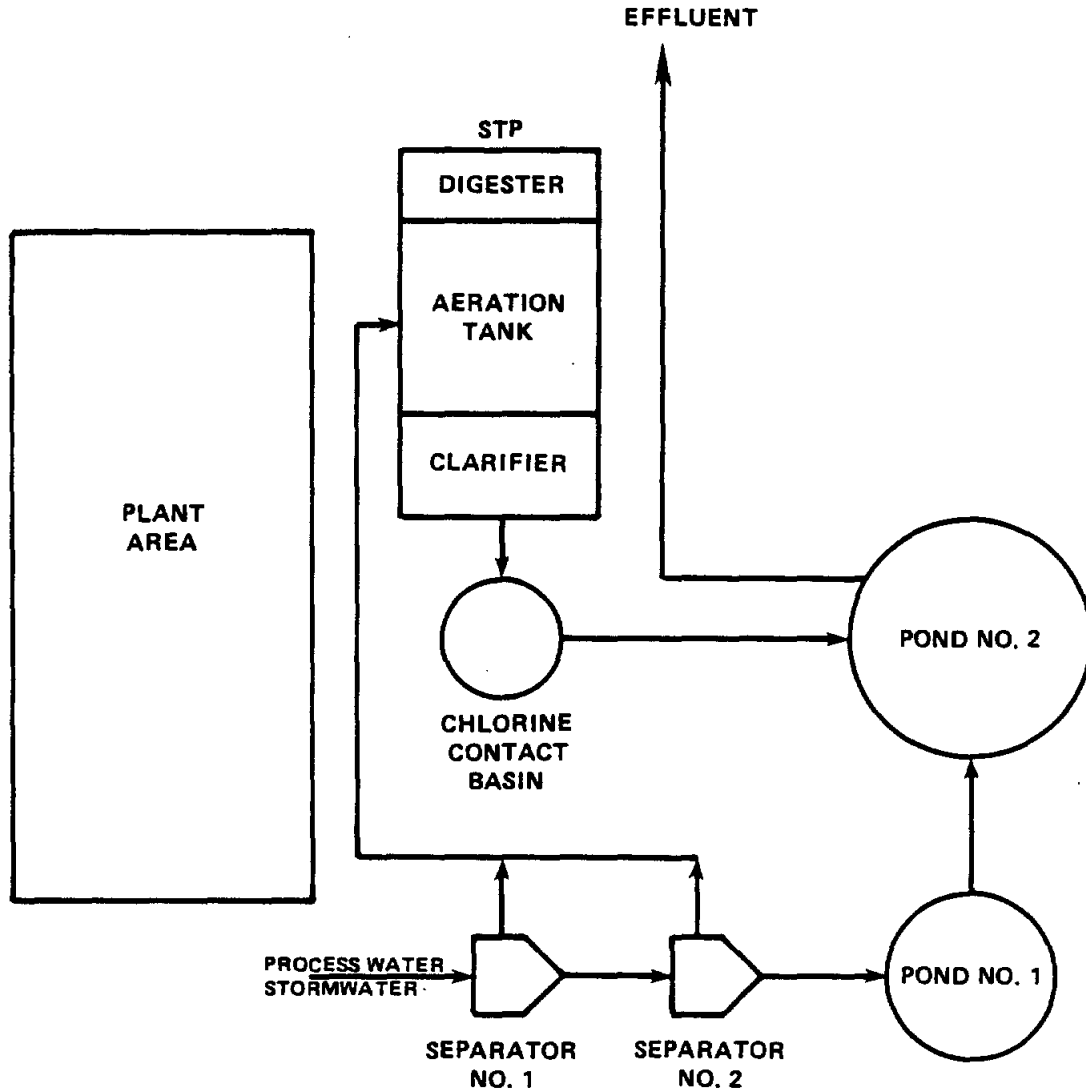

CLEAR LAKE AREA REGIONAL WASTEWATER PLAN			
M. A. HANNA WASTEWATER TREATMENT PLANT FLOW DIAGRAM			
Turner Collie & Braden Inc. ENGINEERS • PLANNERS			
Exhibit	14	Job No. 11-00245-001	Date JAN, 1991

APPENDIX I

Water Conservation and Drought Contingency Plan

APPENDIX I - WATER CONSERVATION AND DROUGHT CONTINGENCY PLAN

1

One of the major tasks for this regional wastewater study is to prepare a Water Conservation Program and Drought Contingency Plan for the study area. According to the information provided by the Texas Water Development Board (TWDB), most of the utilities in the study area already have implemented effective water conservation programs and drought contingency plans. The TWDB records indicate that the Clear Lake City Water Authority, including Harris County WCID No. 75, the cities of Pasadena, Webster, and Nassau Bay, Bay Shore MUD, Shore Acres, and others in the area already have TWDB approved programs. It is critical that these entities continue to implement these approved and effective water conservation programs and drought contingency plans since they can significantly reduce the water and wastewater needs of the area. For those entities that have not developed and adopted such programs and plans, they should be encouraged to do so. The information presented below can be used by these entities for development and implementation of their water conservation programs and drought contingency plans.

WATER CONSERVATION PLAN

Assessment of Supply and Demand Management Potentials

Water conservation measures are often evaluated under two management categories, demand management and supply management. Demand management methods consider water use downstream of the service connection, that is, user-oriented conservation. Demand management provides for education or incentives, such as overall lower water costs, to reduce water consumption by the consumer. This method of conservation generally reduces water revenues since less water is purchased from the water utility. Supply management methods consider water supply upstream of the customer's service connection. The goal of supply management is to reduce water waste and improve efficiency within the production, treatment, and distribution system. Supply management usually results in decreased cost to the water utility as water system losses are reduced. Both demand and supply management techniques were considered in the development of a Water Conservation Plan for the Clear Lake regional wastewater study area.

Demand Management Alternatives

Education and Information

The most readily available and lowest cost method of promoting water conservation is to inform water users about ways to save water inside homes and other buildings, in landscaping and lawn uses, and in recreational uses. An effective education information program can be easily and inexpensively administered by cities and other water management agencies. Materials available from the American Water Works Association (AWWA), the TWDB, and other similar associations can easily be acquired for distribution to customers through handouts, mail-outs, bill stuffers, and other sources. Distribution of materials to school children, another feasible method, promotes conservation at an early age. Local newspapers are most often used for public service announcements, and the various local publications can be used to print articles concerning water conservation. The use of radio stations in the area, together with public and cable television systems, also can be utilized for this purpose.

Plumbing Codes

Water-saving plumbing codes for new construction and replacement of existing plumbing are effective methods of reducing water demands. Water-saving plumbing codes, however, must be adopted and enforced by building inspection to be effective. At the present time, there is no means of enforcing an areawide water conservation plumbing code within the study area. Therefore, this method of water conservation is not considered feasible. An alternative to regulation and enforcement is the extension of the education and information program to include information about water-saving devices on a voluntary basis. This alternative is a viable method and has been considered for adoption into the Water Conservation Plan.

Retrofit Program

Cities and other water management agencies can make information available through their education programs for plumbers and customers to use when purchasing and installing plumbing fixtures, lawn watering equipment, or water-using appliances. Information regarding retrofit devices, such as low-flow shower heads or toilet dams which

reduce water use by replacing or modifying existing fixtures or appliances, can be mailed out to those residents with their monthly billing information.

Water Rate Structure

A water conservation-oriented rate structure usually takes the form of an increasing block rate, although continuously increasing rate structures, peak or seasonal load rates, excess use fees, and other rate forms can be used. The increasing block rate structure is the most commonly used water conservation rate structure. Separate rate structures are usually used for residential, commercial, institutional, and industrial customers. Cities and other water management agencies should review their existing rate structures and adopt a water conservation rate structure.

Water-Conserving Landscaping

In order to reduce the demands placed on a water system by landscape irrigation, the water utility should consider methods that either encourage (by education and information) or require (by regulation) water-conserving landscaping by residential customers and commercial establishments engaged in the sale or installation of landscape plants or watering equipment. In urban communities as much as 35 percent of total residential water use can be traced to exterior uses such as lawn watering and car washing. In some more affluent areas, sprinkler systems are becoming more prevalent. The continued rise and use of such systems, however, are almost self-limiting in that the small diameter distribution mains (2-, 4-, and 6-inches) simply cannot deliver sustained high volumes of water.

Supply Management Alternatives

Universal Metering

All water users, including the water utility and other public facilities, should be metered. A regularly scheduled maintenance program of meter repair and replacement should be established to maintain meter accuracy. Most important, metering can provide an accurate accounting of water uses throughout the system. In addition, the water utility may be able to locate and bill previously unbilled users. Metering and meter repair and

replacement, coupled with an annual water audit, can be used in conjunction with other programs such as leak detection and repair, and thereby save significant quantities of water. Only annual water auditing and accurate billing procedures can detect illegal connections. Each of the cities and water management agencies should be encouraged to implement such programs to determine if illegal connections exist.

Leak Detection and Repair

A continuous leak detection, location, and repair program can be an important part of a water conservation plan. An annual water accounting or audit should be part of the program. Sources of unaccounted-for water include defective hydrants, abandoned services, unmetered water used for fire fighting or other municipal uses, inaccurate or leaking meters, illegal hook-ups, unauthorized use of fire hydrants (where available), and leaks in mains and services. Once located, corrective repairs or actions need to be undertaken.

Recycling and Reuse

A water utility should evaluate the potential of recycling and reuse because these methods may be used to increase water supplies within the service area. Reuse can be especially important where the use of treated effluent from an industry or a municipal system or agricultural return flows replace an existing use that currently requires fresh water from a utility's supply. Recycling of in-plant process or cooling water can reduce the amount of fresh water required by many industrial operations.

Reuse or recycling of treated wastewater within the study area has been used by area golf courses for irrigation purposes. The costs of small scale recycling and reuse programs which might be applicable in areas receiving centralized wastewater treatment, prohibit their implementation except when there is a significant need to reduce water use. Treated effluent for irrigation of parks, golf courses, or similar areas should be encouraged.

Plan Description

Based on the evaluation of alternatives available to the study area for conserving water, the following elements have been selected as those best suited to the needs of the area for water conservation:

Demand Management

- Public Education and Information
- Retrofit Programs (Installation of New Indoor Plumbing)

Supply Management

- Universal Metering/Annual Water Auditing
- Meter Repair and Replacement
- Leak Detection and Repair
- Recycling and Reuse

Incentives which will be stressed include possible deferral of construction of new supply facilities as a result of water conservation measures, increased revenues from adoption of water conservation oriented water-rate structures, and potential increases in revenue or net water supply from connection or disconnection, respectively, of previously unauthorized system users.

When the water conservation program is implemented, cities and other water management agencies should initiate the **education and information programs**. The methods that will be used to distribute first-year information to the public are as follows:

1. An initial fact sheet explaining the new water conservation program and the contents of the drought contingency plan.
2. Two pamphlets on water conservation issued through mail-outs, bill stuffers, door hangers, or other method of direct issuance.
3. Two corresponding announcements concerning water conservation by newspaper, radio, or cable television articles.
4. Print water conservation tips on water bills six times during the year or implement other information activities.

During subsequent years of the program, technical information on water conservation will be provided semi-annually directly to the public in the form of pamphlets or bill stuffers. In addition, water conservation information will be made available to

plumbers and retail distributors of plumbing fixtures and to new customers when they apply for water service. When appropriate, educational materials may be provided in the Spanish language.

As part of their retrofit programs, cities and other water management agencies should provide information through their education program for plumbers and customers to use when purchasing and installing plumbing fixtures, lawn watering equipment, or water-using appliances. Information regarding retrofit devices, such as low-flow shower heads or toilet dams which reduce water use by replacing or modifying existing fixtures or appliances, will be provided to those residents which will be obtaining wastewater service.

In addition to these programs, cities and other water management agencies which do not utilize conservation-oriented water rate structures should be encouraged to do so. Water-conserving landscaping will be emphasized in the education and information program. The practice of universal metering will be supported in discussions with water suppliers. Among other benefits, universal metering will provide for a sound database from which water conservation efforts can be measured. Cities and other water management agencies should consider purchase of leak detection and meter test equipment that can be provided to utilities on a loan basis.

Implementation of the Water Conservation Plan

Cities and other water management agencies will be the agencies in the study area to assume responsibility for implementation and coordination of water conserving efforts.

DROUGHT CONTINGENCY PLAN

Drought, or a number of other uncontrollable circumstances, can disrupt the normal availability of community or utility water supplies. Even though a city may have an adequate water supply, the supply can become contaminated, or a disaster can disrupt or destroy the supply. During drought periods, consumer demand is often significantly higher than normal. Some older systems, or systems serving rapidly growing areas, may not have the capacity to meet higher than average demands without system failure or other unwanted consequences. System treatment, storage, or distribution failures also can present a city or utility with an emergency demand management situation.

It is important to distinguish drought contingency planning from water conservation planning. While water conservation involves implementing permanent water use efficiency or reuse practices, drought contingency plans establish temporary methods or techniques designed to be used only as long as an emergency exists.

An effective Drought Contingency Plan includes the following six elements:

- Trigger Conditions Signaling the Start of an Emergency Period
- Drought Contingency Measures
- Information and Education
- Initiation Procedures
- Termination Notification Actions
- Means of Implementation

Trigger Conditions

For the purposes of this Plan, trigger conditions will be considered on an individual city or water management agency, rather than the study area as a whole. A description of conditions considered mild, moderate, severe, and critical follow:

- Are oftentimes discretionary, based on daily monitoring of water demands and weather forecasts and the water plant operator's judgment.
- Occur when combined pumpage from water plants is in excess of 85 percent of firm capacity for three days, or 90 percent of firm capacity for one day, or when continually falling elevated storage tank levels occur and storage cannot be replenished over 70 percent of maximum tank volume overnight.
- Occur when combined pumpage from water plants is in excess of 90 percent of firm capacity for three days, or 95 percent of firm capacity for one day, or when continually falling elevated storage tank levels occur and storage cannot be replenished over 50 percent of maximum tank volume overnight.
- Are reached when water plant pumpage exceeds 95 percent of firm capacity for three days, or 100 percent of firm capacity for one day, or a major line break or a pump or system failure occurs which causes pressures to drop significantly. Prolonged power outage also constitutes a critical condition.

Emergency Management Program

The following actions shall be taken by individual cities or other water management agencies when trigger conditions are reached:

-
- Request customers to voluntarily limit amount of water used.
 - Increase monitoring of water supply versus demand.
 - Increase leak detection and repair efforts.
 - All of the above conditions, plus.
 - Request odd/even lawn irrigation on daily basis depending on house address.
 - Request no swimming pool refilling, car washing, or other types of outdoor water uses.
 - Request that restaurants do not serve water unless requested by customer.
 - Continue implementation of all Stage 2 restrictions, except reduce lawn irrigation to every two days, e.g., even house addresses on Sunday and Thursday, odd house addresses on Tuesday and Saturday, etc.
 - Request reduction of all outside water use.
 - If voluntary efforts do not produce required results, reduce water plant operating pressure to reduce water demand during peak periods if possible.
 - Maintain normal pressure during off-peak hours to fill elevated storage tanks.
 - Prohibit all public water uses not required for health or safety.
 - Prohibit all outside water use.
 - Reduce plant operating pressures to maintain a minimum residual of 40 psi in the system when excessive water demands are the cause of critical conditions.
 - Isolate remaining elevated storage for fire or emergency reserve.

Information/Education

As a component of the Information/Education section in the Water Conservation Plan, the purpose and effect of the Drought Contingency Plan will be communicated to the public through articles in local newspapers, supplemented by pamphlets distributed at the same time and public service announcements on local television.

When trigger conditions appear to be approaching, the public will be notified through publication of articles in local newspapers with information on water-conserving methods. During critical conditions, signs may be posted at public buildings (libraries, schools, etc.).

When trigger conditions have passed, the local newspaper will publish notification that drought contingency measures are abated for that condition, and, if applicable, will outline measures necessary for the reduced condition.

APPENDIX II
Public Comments

RESOLUTION NO. 90-323

WHEREAS, the City of Taylor Lake Village, Texas, has for some years recognized a need for one central wastewater collection and treatment agency; and

WHEREAS, multiple small treatment plants have a history of improper processing of waste; and

WHEREAS, our area is prone to flooding; and

WHEREAS, our City is on three sides bordered by recreation lakes that are heavily used by swimmers, water skiers, and fishermen; and

WHEREAS, fish kills have become common events; and

WHEREAS, our citizens are demanding that this Mayor and Council take steps to eliminate as far as possible the multiplicity of small waste treatment plants discharging into our recreational water ways; NOW, THEREFORE,

BE IT ORDAINED BY THE CITY COUNCIL OF THE CITY OF TAYLOR LAKE VILLAGE, TEXAS:

Section 1. The City of Taylor Lake Village wholeheartedly supports the recently completed Regional Wastewater Treatment Plant Study and its' conclusions. The City requests that the Texas Water Commission evaluate this study and work with organizations in this area to implement conclusions in the best interests of our citizens.

PASSED AND APPROVED THIS THE 5th DAY OF December, 19 .

CITY OF TAYLOR LAKE VILLAGE

James E. Cumming, Mayor

ATTEST

Alice C. Riley, City Secretary

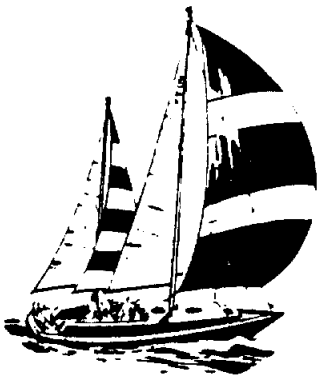

CITY OF SHOREACRES

601 SHOREACRES BOULEVARD
SHOREACRES, TEXAS 77571
(713) 471-2244

"A COMMUNITY OF BEAUTIFUL HOMES ON GALVESTON BAY"
HOME OF THE HOUSTON YACHT CLUB

MAYOR
James L. Neal

November 14, 1990

CITY SECRETARY
Cindy Logan

Mr. Vance Kemler
Gulf Coast Waste Disposal Authority
910 Bay Area Boulevard
Houston, Texas 77058

RECEIVED
NOV 15 1990
GULF COAST AUTHORITY

Dear Mr. Kemler:

The draft report dated September, 1990, by Turner, Collie & Braden, Inc., entitled "A Regional Wastewater Facility Plan for the Clear Lake Area" has been reviewed by the appropriate officials of the City of Shoreacres.

The recommendations concerning the City of Shoreacres wastewater are the same in each of the three alternatives in the report and are consistent with current treatment of Shoreacres wastewater. Therefore, any of the three alternatives are acceptable to Shoreacres.

Sincerely,

James L. Neal
James L. Neal
Mayor

HARRIS COUNTY MUNICIPAL UTILITY DISTRICT NO. 181
1200 Travis Street, Suite 1800
Houston, Texas 77002-6098

November 20, 1990

Mr. Vance Kemler
Gulf Coast Waste Disposal
Authority
910 Bay Area Boulevard
Houston, Texas 77058

Texas Water Development Board
P. O. Box 13231
Austin, Texas 78711-3231

Turner, Collie & Braden, Inc.
5757 Woodway
Houston, Texas 77057

Re: Draft report on regional
wastewater facility plan
for the Clear Lake area
dated September, 1990;
response from Harris County
Municipal Utility District
No. 181

Ladies and Gentlemen:

Harris County Municipal Utility District No. 181 ("District") is located within the City of Taylor Lake Village, Texas, and exists within the study area for the proposed regional wastewater facility plan for the Clear Lake area as developed under the draft report dated September, 1990 submitted by Turner, Collie & Braden, Inc. The District is currently served by both Harris County Water Control & Improvement District No. 75 and Clear Lake City Water Authority for wastewater service.

After review of the draft report on the regional wastewater facility plan for the Clear Lake area ("Draft Report") and review of the position of the District with regard to the proposed regional alternatives in the Draft Report, it appears that Regional Alternative No. 1, set forth on pages IV-3 through IV-10 is the most feasible and economically beneficial alternative to serve the constituents of the District. The service area within the District and within a good portion of Taylor Lake Village would be diverted to a Clear Lake City Water Authority wastewater treatment plant which can be expanded for treatment of the additional waste. Additionally, there are existing wastewater treatment service lines which could feasibly be used to transport the waste to the Clear Lake City Water Authority plant.

November 20, 1990

Page -2-

The other regional alternatives presented by the Draft Report, which include a proposal to pump waste from the City of Taylor Lake Village and surrounding area to the Gulf Coast Waste Disposal Authority Bayport plant, would be much more difficult to achieve and would no doubt have a much higher cost to the parties who must construct lines for transportation of the waste. Therefore, the District urges the acceptance of Regional Alternative No. 1 for the permanent regional plan for treatment of wastewater for the Clear Lake area.

It is understood that some legal requirements must be met prior to the use of the Clear Lake City Water Authority Plant by all of the property designated within Regional Alternative No. 1 service area. Clear Lake City Water Authority may need to seek an exemption from its requirement that it not treat wastewater produced from lands that lies within certain lower elevations or may need to seek a determination from its own attorneys that the expansion of the plant, not being constructed with funds obtained under the EPA grant placing such restriction on the use of the money, would allow the treatment of the additional wastewater without such exemption. Clear Lake City Water Authority would also need to enter into a series of Interlocal Government Agreements with the other political subdivisions to be served, as annexation of another political subdivision would not be possible.

Additionally, the District urges that whatever regional alternative is accepted be coordinated with an application to the Texas Water Commission for the designation of the regional wastewater facility plan for the Clear Lake area and the treatment areas as regional plants under Chapter 13 of the Texas Water Code. To require landowners to join in regional wastewater treatment and to require the various jurisdictions with available facilities to treat such properties, it will be necessary and desirable to obtain the consent and cooperation of the Texas Water Commission in coordinating the issuance of discharge permits and inclusion within permitted areas this regional planning.

The District hopes that the program for regionalization of wastewater treatment goes forward, as the proliferation of small wastewater treatment plants and discharge into nearby recreational waters is undesirable and can be alleviated through a comprehensive and environmentally sound program.

Very truly yours,

BOARD OF DIRECTORS
HARRIS COUNTY MUNICIPAL UTILITY
DISTRICT NO. 181

cc: Mayor Jim Cumming
City of Taylor Lake Village
Harris County WCID No. 75
Clear Lake City Water Authority



CLEAR LAKE CITY WATER AUTHORITY

900 Bay Area Boulevard • Houston, Texas 77058 • 713/488-1164
• FAX 713/488-3400

January 29, 1991

Mr. Minh Chu
Turner, Collie & Braden, Inc.
5757 Woodway
Houston, Texas 77219

Re: Regional Wastewater Facility Plan
for the Clear Lake Area

Dear Mr. Chu:

The Clear Lake City Water Authority conceptually endorses and agrees with the conclusions of the report. However, the complete implementation of the plan may present several problems for the Authority. The problems uncovered to date are reviewed in the attached engineer's review of the area which the Clear Lake City Water Authority is asked to serve under this Regional Plan alternative 3.

Sincerely,

CLEAR LAKE CITY WATER AUTHORITY

Donald J. Schelfhout, Vice President
Board of Directors

DJS:dd

Attachment

A Regional Wastewater
Facility Plan For The Clear Lake Area

Contract No. 90-483-753

The following maps are not attached to this report. Due to their size, they could not be copied. They are located in the official file and may be copied upon request.

Existing Sanitary Sewer Systems Exhibit 7 Job No. 11-00245-001 January 1991

Regional Alternative 1 Exhibit 15 Job No. 11-00245-001 January 1991

Regional Alternative 2 Exhibit 16 Job No. 11-00245-001 January 1991

Please contact Research and Planning Fund Grants Management Division at (512) 463-7926 for copies.