

RECEIVED

JUL 10 2000

TWDB R&F
GRANTS MANAGEMENT

TurnerCollie & Braden Inc.

DRAFT

INVESTIGATION OF JOSLIN STEAM ELECTRIC STATION FOR CO-LOCATION OF A DESALINATION FACILITY

Prepared for

**Lavaca Regional Water Planning Group
in Conjunction with Region L and N
Planning Groups**

THIS DOCUMENT IS RELEASED FOR THE PURPOSE
OF "INTERIM REVIEW" UNDER THE
AUTHORITY OF:

MARK VERNON LOWRY, P.E.
SERIAL NO. 37995
JUNE 28, 2000

THIS IS NOT TO BE USED FOR CONSTRUCTION,
BIDDING, OR PERMIT PURPOSES.

June 2000

Job No. 37-00600-002

TABLE OF CONTENTS

SECTION I EXECUTIVE SUMMARY

Summary Results	I-2
-----------------------	-----

SECTION II PROJECT SUMMARY REPORT

Suitability of CP&L Power Plant for Co-Siting Desalination Facility	II-1
Desalination Process and Pre-Treatment Process Selection	II-1
Desalination Plant Environmental Issues.....	II-2
Plant Level Estimates of Probable Costs.....	II-3
Cost Estimate Summary Option LNRA-1a Second Quarter 1999 Prices	II-4
Cost Estimate Summary Option LNRA-1b Second Quarter 1999 Prices.....	II-5
Alternative Institutional Structures	II-6
Potential Risk and Cost Reduction	II-6
Potential Use of GLO Natural Gas	II-7
Interbasin Transfer Requirements	II-7
State Participation	II-7
Overall Summary Results	II-8

TABLES

Table 1	Cost Estimate Summary, Point Comfort Desalt Option LNRA-1a
Table 2	Cost Estimate Summary, Combined Option LNRA-1b

EXHIBITS

Exhibit 1	Vicinity Map
Exhibit 2	Location Map of Joslin Steam Electric Station Site
Exhibit 3	Options for Reject Water Disposal

APPENDICES

Appendix A	Site Evaluation and Desalination Processes
Appendix B	Desalination Plant Environmental Issues
Appendix C	Conventional Surface Water Treatment, Transmission, and Distribution Costs
Appendix D	Legal, Institutional & Permitting

Section I - Executive Summary

The Texas Water Development Board provided funds from the SB1 Planning Process for a site specific desalination project. This project represents a cooperative effort among three regional planning areas, namely Regions P, L and N, with support and encouragement from Region K. It also involves participation and cooperation from the Lavaca-Navidad River Authority, the Guadalupe-Blanco River Authority, the Nueces River Authority, the San Antonio River Authority, the San Antonio Water System, Bexar Metropolitan Water District and the City of Corpus Christi. It is unique in that the entities mentioned above are trying both to expand the available water supply, as well as work together to help reduce any shortages in the individual areas. A fundamental precept of this study is to preserve and protect low cost supplies of water for agriculture by providing alternative supplies to industries and municipalities. State agencies represented include the Texas Water Development Board, Texas Parks and Wildlife Department, the Texas Natural Resource Conservation Commission, Texas General Land Office and the Texas Department of Agriculture. Consultant team members include Turner Collie & Braden Inc., U.S. Filter, Dr. George Ward, Attorney Doug Caroom and HDR Engineering Inc.

Recent developments in the technology for separating salt from salt water have greatly reduced the cost, making desalination a realistic water supply option worth serious consideration. However, the estimation of these costs is highly dependent upon location of the facilities, particularly with regard to co-locating a desalination plant with a power plant, either existing or planned. Even with the rapidly changing nature of the desalination industry, all of the components that are represented for cost estimation purposes are modules that are currently available as "off the shelf" technology. The important part of this study is the packaging of this equipment to provide the optimum system for converting salt water to drinking water.

Several options were studied, with the option selected being a reverse osmosis plant with an estimated output of 100,000 acre-feet/year. The proposed plant uses 200,000 acre-feet/year of raw water, pretreats the water to remove the suspended solids in it and discharges reject water from the plant that has a salt content of approximately 48,000 mg/l or less, 90 percent of the time. Production of the 100,000 acre-feet/year can be accomplished at an estimated cost of \$3.37 per 1000 gallons treated, delivered and distributed in San Antonio. When packaged with an available 100,000 acre-feet/year of surface water using a conventional surface water treatment plant, the combined wholesale cost for 200,000 acre-feet/year of treated water delivered and distributed in San Antonio is \$2.80 per 1000 gallons.

Environmental impacts of desalination were examined on a preliminary basis and appear acceptable. Impact of saline effluent discharge on the receiving water was estimated for temperature, suspended solids, toxicity and salinity. The pretreatment facilities proposed do not add any chemicals to the solids, so discharge of the silt removed in the pretreatment process would not add toxicity. Removal of a portion of the heated cooling water discharge from the power plant would have a beneficial environmental effect by reducing the heat load imposed on the bay. Increases in salinity are small for discharges into either the Lavaca Bay system or the Matagorda Bay system, both of which were evaluated on a planning study level. The conclusions reached were that environmental issues would need further definition, however none of the effects reviewed constitutes a fatal flaw that would

prevent further consideration of this project. Costs were developed for alternative discharge locations and for land disposal of the solids generated to determine the impact on overall cost. Further study was recommended for localized effects of suspended solid and salinity in the effluent as well as the potential impacts of toxicity from concentration of elements already in the water.

This study also looked at the potential impacts and barriers to the use of the public/private partnership for project accomplishment, as well as the Design/Build/Operate (D/B/O) method of accomplishing the project objectives. The costs developed did not include any potential savings from these methods, although estimates of 15 to 30 percent savings have been reported. The legal issues surrounding the use of these tools were examined, and it was determined that the public/private partnership and the D/B/O options were available based upon the makeup of the entity that was contracting for the services. Issues regarding the ownership and timing of the availability of the Joslin Power Plant were also investigated and will be the focus of continued discussion with the plant owners.

Summary Results:

1. 100,000 acre-feet/year of salt water from Lavaca Bay can be treated, transmitted and distributed in San Antonio, when combined with an existing 100,000 acre-feet/year of treated surface water (Corpus Christi, Garwood and Guadalupe River at saltwater barrier). The cost is comparable to that of building a new reservoir, but can be accomplished in considerably less time than construction of a new reservoir.
2. Costs reported here are very conservative and do not include savings that could be achieved through the D/B/O option (potentially 15-30 percent), acquiring a natural gas supply through GLO, and other options. Costs are prepared to be directly comparable to the costs used for other Region L management options.
3. Sensitive environmental issues exist that must be accounted for, but none represents a fatal flaw at this point in the analysis.
4. The legal and permitting issues raised appear to be attainable.
5. The coalition of entities participating sets a precedent for interregional cooperation in resolving water issues.

We believe the Joslin Desalination Project is an economically viable and environmentally acceptable, long-term, drought proof water supply for the San Antonio area and plan to present it to the Region L planners for their consideration in the immediate future.

Section II – Project Summary Report

6-6.1
6-6.2

Lavaca Regional Water Planning Group describes the findings of its planning level study to define the most cost-effective, environmentally responsible process for desalinating seawater to provide a drought-proof water supply for potential application in the South Central Texas Region L (including San Antonio) and Region N (including the Corpus Christi area). The alternative under consideration involves co-siting a desalination plant with Central Power & Light's (CP&L's) Joslin Steam Electric Station in Point Comfort, Texas. *Exhibit 1* shows a vicinity map of the project area while *Exhibit 2* shows the CP&L property boundary (200 acres) and the Joslin Steam Electric Station. This investigation was prompted by recent significant reductions in cost of membrane processes which remove salt from bay water or sea water. A portion of these cost reductions have come as a result of co-location of the desalination plant with an electrical generation facility, using saltwater for once through cooling. This summary report synthesizes the support documents that are provided in the appendices. References are omitted in the summary report but are included in the support documents.

Suitability of CP&L Power Plant for Co-Siting Desalination Facility

A preliminary review of the Joslin Steam Electric Station plant site revealed that sufficient land area exists to co-locate a reverse osmosis or a combined cycle reverse osmosis/multiple effect distillation plant, even if the plant is to be re-powered. It was also determined that the current intake structure and pumping facilities are sufficient to provide the approximately 180 million gallons per day (MGD) of raw water to serve as feedwater to the desalination process. It was further determined that power for such a plant is available on site at a cost of \$0.04 per kilowatt-hour. An analysis of the heat cycle in the plant determined that there are no obvious opportunities for capturing any waste heat, as the plant is designed to make maximum use of each pound of steam generated. The only opportunity for a combined cycle plant is during periods when the plant is operating at partial load.

Desalination Process and Pre-Treatment Process Selection

The most cost-effective treatment process is a "stand-alone" reverse osmosis (RO) desalination plant with motor drives for the high-pressure pumps. Input of approximately 180 MGD of cooling water would be required, and the plant would produce approximately 90 MGD of low solids drinking quality water and 90 MGD of reject hypersaline water. This process exhibits the lowest capital and operating costs and the lowest cost of water of the alternatives evaluated. Alternative processes that were investigated included use of steam for both pumping and for a Multiple Effect Distillation demineralization process. A third option investigated was the use of a combined Reverse Osmosis, Multiple Effect Distillation facility with a new power plant on the existing site. None of the steam options provided a lower cost than the use of a reverse osmosis system with conventional pumping.

The pretreatment process proposed consists of a system of cartridge microfiltration filters submerged in an open tank (CMF-S). The CMF-S process is a modular design that operates by submerging banks of filters in an open tank approximately 8 feet deep and drawing a vacuum on the interior of the filter to pull filtered water through. This process was selected for costing based on anticipated cost savings as well as the fact that it adds no chemicals to the water and has no mechanical devices in the raw water side, which might cause harm to organisms that have passed through the intake screens. By neither adding chemicals nor destroying any live organisms in the feedwater, this process increases the

likelihood of being able to satisfy any environmental concerns about the return of the reject water and the solids to the marine environment.

Total cost of treatment per 1000 gallons treated in an 89.3 MGD RO plant co-located at the Joslin SES was determined to be \$1.75 or \$569.80 per acre-foot. These costs assume significant savings from location of the RO plant on the existing power station site by sharing of common facilities and in reduction of manpower by sharing power plant personnel in the supervision and operation of the desalination facility. These costs further assume that the reject water and solids produced in the pretreatment process are returned to Cox Bay with the remaining cooling water through the existing Joslin structure. A detailed description of these processes is provided in *Appendix A-1*. Detailed combined final costs and reject water and solids costs are provided in *Appendix A-2*.

Desalination Plant Environmental Issues

6.6.3 The preliminary review of the environmental aspects of the proposed plant, related to the aquatic system of Lavaca Bay (including Cox Bay), determined that there is no environmental fatal flaw in the project that would prohibit its further consideration. This alternative disposes the reject water and solids through the existing discharge structure as shown on *Exhibit 2*. Preliminary evaluations of the desalination plant operation concluded:

- No toxicity in the combined return flow
- Reduced heat load, a minor benefit to the aquatic environment
- Incremental salinity load
- No alterations in the present entrainment and impingement (E&I) impacts of the Joslin plant

Operation of a desalination facility providing approximately 90 MGD of treated water would result in a small but measurable increase in salinity in the Lavaca Bay system. Two alternative disposal locations of the reject water and solids were reviewed: Matagorda Bay and offshore in the Gulf of Mexico. Desalination Plant reject water and solids would be conveyed through a proposed pipe line to one of the two alternative disposal locations. If the reject water is piped to Matagorda Bay, the effect would not be significant with regard to increased salinity. The Gulf of Mexico disposal alternative was prepared as a worst case scenario as its costs exceed the Matagorda Bay alternative as shown in *Appendix A-2*. Removal of a portion of the cooling water (e.g., the 90 MGD produced water) would have a beneficial effect by reducing the present power plant heat load to Cox Bay. The locations of two options for disposing the reject water are shown on *Exhibit 3*.

Quantities of solids filtered from the feedwater in the pretreatment system are estimated assuming a total suspended solids (TSS) level in the screened cooling water of 50 mg/l, based on averages from the field data available. Based on treating 180 MGD, this process will produce approximately 75,000 pounds of dry solids per day, or 341,000 pounds of wet solids per day assuming that sludge is concentrated to 22 percent solids. The base case assumes that there is sufficient value in the nutrient content of the solids and potentially live biologics to warrant being returned to Cox Bay without further treatment. The net effect on Cox Bay would be negligible since all of the solids were withdrawn from the water initially, but there could be potentially localized effects on certain populations, such as oysters. *Appendix B* describes these environmental issues in further detail.

Additional environmental studies will probably be necessary as the plant design proceeds, including more detailed quantification of the effect of returning the reject water and/or the filtered solids to the bay environment. Additional E&I concerns may arise depending upon information about present entrainment mortality. A need to carry out detailed salinity modeling may develop if there are any ecological areas within influence of the project sensitive to salinity (e.g. oyster reefs).

As an alternative to the base case, the costs of trucking and landfilling the sludge are estimated. No permits would be required for this process, and it is assumed that the solids are hauled and disposed of by contract, so there is only an annual cost associated with the process. It is further assumed that the solids are hauled in open top, 40-cubic yard trailers, with a payload capacity of 40,000 pounds per load. Solids would be produced at the rate of 8.5 truckloads per day. The tables in *Appendix A-2* describe these costs in further detail.

Conventional Surface Water Conveyance, Treatment, and Transmission

In addition to the desalination facility, a second portion of the study was dedicated to assembling costs for the transmission of raw water from the Colorado River to the Lake Texana Pumping Station, pumping through the Mary Rhodes Pipeline to the interim pump station at Bloomington, and then to a surface water treatment plant that treats the Colorado River water and water from the Guadalupe River Salt Water Barrier. The capacity of this plant is 100,000 acre-feet per year, or approximately 90 MGD. Separate layouts were prepared for transmission lines and pump stations to move three separate water volumes to San Antonio, independent of each other: 90 MGD of desalinated water, 90 MGD of treated surface water, and 180 MGD of combined desalinated and conventionally treated surface water. The costs developed included modifications to the San Antonio Water System's distribution system to accommodate the additional flow. These costs were developed for other Region L planning studies and are included in *Appendix C*.

Planning Level Estimates of Probable Costs

6.614
Planning level estimates of probable cost were prepared for the treatment, transmission, and distribution of desalinated bay water, conventionally treated surface water, and a combination of the two assuming that the reject water and the solids removed in the pretreatment process are discharged back into the existing cooling water discharge location. These costs are summarized in *Table 1* for Option LNRA-1a. When combined with the treated surface water from the Guadalupe and Colorado Rivers as a single project, the overall project cost is summarized in *Table 2* for Option LNRA-1b.

In order for the information developed under this contract to be directly comparable to other alternatives currently being investigated by Region L, the estimates of probable cost were prepared using the same costing spreadsheet developed by HDR Engineering Inc. for the Region L analyses. As a result, the estimates of probable cost presented in *Tables 1* and *2* represent conventional design and financing methods.

TABLE 1 COST ESTIMATE SUMMARY POINT COMFORT DESALT OPTION LNRA-1A SECOND QUARTER 1999 PRICES	
<i>Item</i>	<i>Estimated Cost for Facilitie</i>
Capital Costs	
Pump Station (89.3 MGD)	\$5,994,000
Transmission Pump Station(s) (3)	\$28,417,000
Transmission Pipeline (72-inch dia.; 156 miles)	\$205,155,000
Water Treatment Plant (89.3 MGD) - Desalination Plant at Joslin	\$195,448,000
Distribution	\$94,189,000
Total Capital Cost	\$529,203,000
Engineering, Legal Costs and Contingencies	\$158,761,000
Environmental & Archaeology Studies and Mitigation	\$3,928,000
Land Acquisition and Surveying (772 acres)	\$7,296,000
Interest During Construction (2 years)	\$55,936,000
Total Project Cost	\$755,124,000
Annual Costs	
Debt Service (6 percent, 30 years)	\$54,858,000
Operation and Maintenance	
Intake, Pipeline, Pump Station	\$3,767,000
Water Treatment Plant	\$20,903,328
Water Treatment Plant Energy Costs (_ kW-hr @ _ \$/kW-hr)	\$16,563,672
Pumping Energy Costs (229,683,216 kW-hr @ 0.06 \$/kW-hr)	\$13,781,000
Total Annual Cost	\$109,873,000
Available Project Yield (acft/yr)	100,000
Annual Cost of Water (\$ per acft)	\$1,099
Annual Cost of Water (\$ per 1,000 gallons)	\$3.37

TABLE 2 COST ESTIMATE SUMMARY COMBINED OPTION LNRA-1B SECOND QUARTER 1999 PRICES	
<i>Item</i>	<i>Estimated Costs for Facilities</i>
Capital Costs	
Diversion Facilities (96" diam., 251 cfs)	\$27,800,000
Off-Channel Reservoir (20,000 acft, 1,218 acres)	\$13,626,000
Pump Station at Joslin (89.3 MGD)	\$5,994,000
Intake and Pump Station at Bloomington (178.6 MGD)	\$15,945,000
Transmission Pump Stations (2)	\$26,149,000
Transmission Pipeline (72 in dia., 273 miles)	\$364,012,000
Water Treatment Plant & Desal Plant each (89.3 MGD)	\$251,548,000
Distribution	\$161,879,000
Total Capital Cost	\$866,953,000
Engineering, Legal Costs and Contingencies	\$284,176,000
Environmental & Archaeology Studies and Mitigation	\$5,822,000
Land Acquisition and Surveying (2,352 acres)	\$9,825,000
Interest During Construction (2 years)	\$93,343,000
Total Project Cost	\$1,260,119,000
Annual Costs	
Debt Service (6 percent, 30 years)	\$89,850,000
Reservoir Debt Service (6 percent, 40 years)	\$1,552,000
Operation and Maintenance	
Intake, Pipeline, Pump Station	\$6,730,000
Dam and Reservoir	\$204,000
Water Treatment Plant	\$27,979,000
Pumping and Treatment Energy Costs	\$42,595,000
Purchase of Water (65,000 acft/yr @ \$61/acft)	\$3,965,000
Annual Cost Salt Water Barrier and Joslin Desalt	\$172,875,000
Annual Cost Garwood	\$9,940,563
Total Annual Cost	\$182,816,399
Available Project Yield (ac-ft/yr)	200,000
Annual Cost of Water (\$ per acft)	\$914
Annual Cost of Water (\$ per 1,000 gallons)	\$2.80

If reject water must be disposed of by pipeline into Matagorda Bay, it adds \$0.08 per 1000 gallons to the desalination facility alone and \$0.04 per 1000 gallons to the combined output of the two processes. If solids must be trucked offsite and disposed of in a landfill, the cost of this operation adds \$0.07 per 1000 gallons for the desalination facility alone or \$0.03 per 1000 gallons for the combined output of the two processes based on a 50 mg/l average TSS load and no chemical addition. If the reject water must be disposed of in Matagorda Bay and the solids must be trucked offsite, the cost for the desalination plant alone plus reject water piping plus solids disposal is \$3.59 per 1000 gallons, and the cost for the combined project is \$3.02 per 1000 gallons. The detailed costs are shown in *Appendix A-2*.

Alternative Institutional Structures

6.6.5 The potential for a partnership of public and private entities was examined, particularly as it relates to the Design/Build/Operate concept under current Texas Law. The D/B/O process cannot currently be used by public entities in Texas because of existing laws governing procurement of engineering services in Texas. However, the practice has been successful where the public entities create a non-profit development corporation, which then works through the D/B/O process and provides water to the public entity under a long-term contract. A public-private partnership for this process could include LNRA as the managing partner for the desalination and transmission facilities; GBRA as the managing entity of the surface water treatment plant at the Guadalupe Salt Water Barrier; City of Corpus Christi as the provider of raw surface water from the Colorado River under contract to LNRA or GBRA for treatment and provision to SAWS; SAWS as the receiver and responsible for the improvements to their distribution to integrate the new water into their existing distribution system; and a non-profit corporation established by the public entities to own, operate, and or manage the desalination facilities. The non-profit corporation would also need an arrangement with the owner of the power generation facilities, whomever that may be, for the location and use of the power plant site for the desalination portion of the project.

Use of the D/B/O process offers some advantages to the conventional process and a potential for cost savings. However, the savings are somewhat site and contract specific, and there is no automatic savings that result from the process. The primary advantage to the public entities is that the D/B/O process can proceed at a faster pace as the site work and preparation of the area can be proceeding with final design. A second advantage is that most D/B/O contracts are awarded based on a cost for water treated and distributed. As a result, there are no change orders during the construction process to increase costs of the facility. In most cases, the successful bidder utilizes equipment produced by his company(s) and volume buying of the plant components reduces the cost. At the same time, the successful bidder generally builds more automatic controls into the plant to reduce maintenance and operations dollars in the long run.

Potential Risk and Cost Reductions

In addition to the items mentioned above, the D/B/O process also transfers much of the risk from the public entity to the private entity that is bidding on the project. Once the bids are received, the public entity is only obligated to consider the bids and determine whether or not they are willing to pay the costs included in the bids. Once a contract is signed, the delivery cost of the water is established, and

any risk of increasing federal requirements, project cost overruns, change orders, and other cost escalations that are a normal part of the conventional process are the responsibility of the private entity and do not affect the long-term cost of the water delivered. This transference of risk of unanticipated cost increases is oftentimes very attractive to public entities with limited budgets. It provides a greater degree of certainty of costs and eliminates some unpleasant surprises during the middle of the budget cycle.

In addition to the reduction in level of risk noted above, there have been a number of instances of reductions in cost from the D/B/O process. While the amount of savings depends upon the individual project, savings of 15 to 30 percent of the overall project cost have been reported. This project represents a particularly good opportunity to utilize the D/B/O process because it is an entirely new facility requiring a highly technical staff for operation, and that staff does not currently exist. A entire new staff must be hired and trained to operate the facility in conjunction with the existing power plant staff.

Potential Use of GLO Natural Gas

Discussions were held with the General Land Office about the possibility of entering into a long-term agreement with that office for the use of GLO gas in the Joslin plant and the provision of power generated from burning that gas to state universities and school districts. The investigation revealed that there is no specific rule or law that would prevent such an alliance, and that there is interest on the part of both parties. No specifics on fuel cost were developed, as this was a preliminary expression of interest only; however, representatives of the GLO have been involved throughout the study.

Interbasin Transfer Requirements

The interbasin transfer requirements established under the Senate Bill 1 regional planning process do not appear to be a significant impediment to the cost or the viability of the project. These requirements state that the rights for water transferred out of a particular basin become junior to all other rights in the basin of origin. In the case of the Garwood water, the rights to that water were secured prior to the passage of SB1 and this provision does not apply. In the case of the water at the Guadalupe Salt Water Barrier, this water has traveled downstream meeting all of the necessary instream flow and in basin requirements. It can only be removed at this location, and the junior rights provision would have little effect. Similarly, the amount of available brackish water in the bay is large and the numbers of existing permits are small in comparison, so the imposition of a junior rights issue with the bay water would not appear to limit the amount that would be available. This is an issue that will be reviewed by the TNRC as to whether or not it is in the best interests of the state to convert this bay water to drinking water, but that determination will be separate and apart from the interbasin transfer evaluation.

State Participation Funding

Finally, this study required an analysis of the potential effects of TWDB state participation funding on cost of water to the end user. The terms of the state participation funding serve only to extend the

construction financing period, with the state participation paying the principal cost of oversizing the necessary facilities to provide capacities needed at a later date but not needed for the current project. Once the additional capacity is required, the entity needing the capacity must pay not only the deferred capital cost, but also the interest that has accrued during the deferral period. Several economic model runs were performed to determine the necessary cash flow needed to make this project viable. From these analyses, it was determined that the treated water cost from the desalination plant is highly dependent upon the plant capacity. The treatment plant can be built in modules of 10 MGD increments, and the pipeline can be built to the maximum size with state funding making up the difference in capital cost; however, the increased cost of water from the smaller plant on a per 1000 gallons basis is likely to offset any benefits from the state participation. The most economical method of operation for the desalination facility is the installation of a 25 MGD module the first year and then the addition of 25 MGD modules each year until the plant is complete. In fact, if the issues of reject water disposal and solids disposal can be resolved without trucking the solids, i.e., piping the reject water to Matagorda Bay or the Gulf of Mexico, then a plant size of 110 to 120 million gallons per day can provide a further reduction in the cost per 1000 gallons of water treated. A detailed description of the legal, institutional, and permitting issues regarding this project is provided in *Appendix D*.

Overall Summary Results

1. A combined desalination plant at the Joslin Power Plant and water from the Guadalupe and Colorado Rivers can provide 200,000 acre feet of water treated, transmitted and distributed to San Antonio for a cost that is comparable to securing water from new reservoirs. In addition, the project appears to offer a potential reduced implementation time frame of 3 to 5 years, as opposed to 15 years or more to construct a new reservoir.
2. Environmental issues do exist that need further study, but no large parcels of existing land must be secured through eminent domain (with the exception of pipeline rights of way), and no large tracts of bottomland hardwoods or inland habitat will be lost if this project proceeds. The analysis so far indicates that there is no fatal flaw represented by the environmental issues that remain to be addressed.
3. Costs reported here are conservative and do not include savings that could be achieved through the D/B /O option (potentially 15 to 30 percent) savings from acquiring a low cost gas contract from the GLO and other options. Costs are prepared to be directly comparable to the costs for other Region L management options.
4. Legal and permitting issues raised appear to be attainable.
5. The coalition of agencies participating sets a precedent for interregional cooperation in resolving water issues.

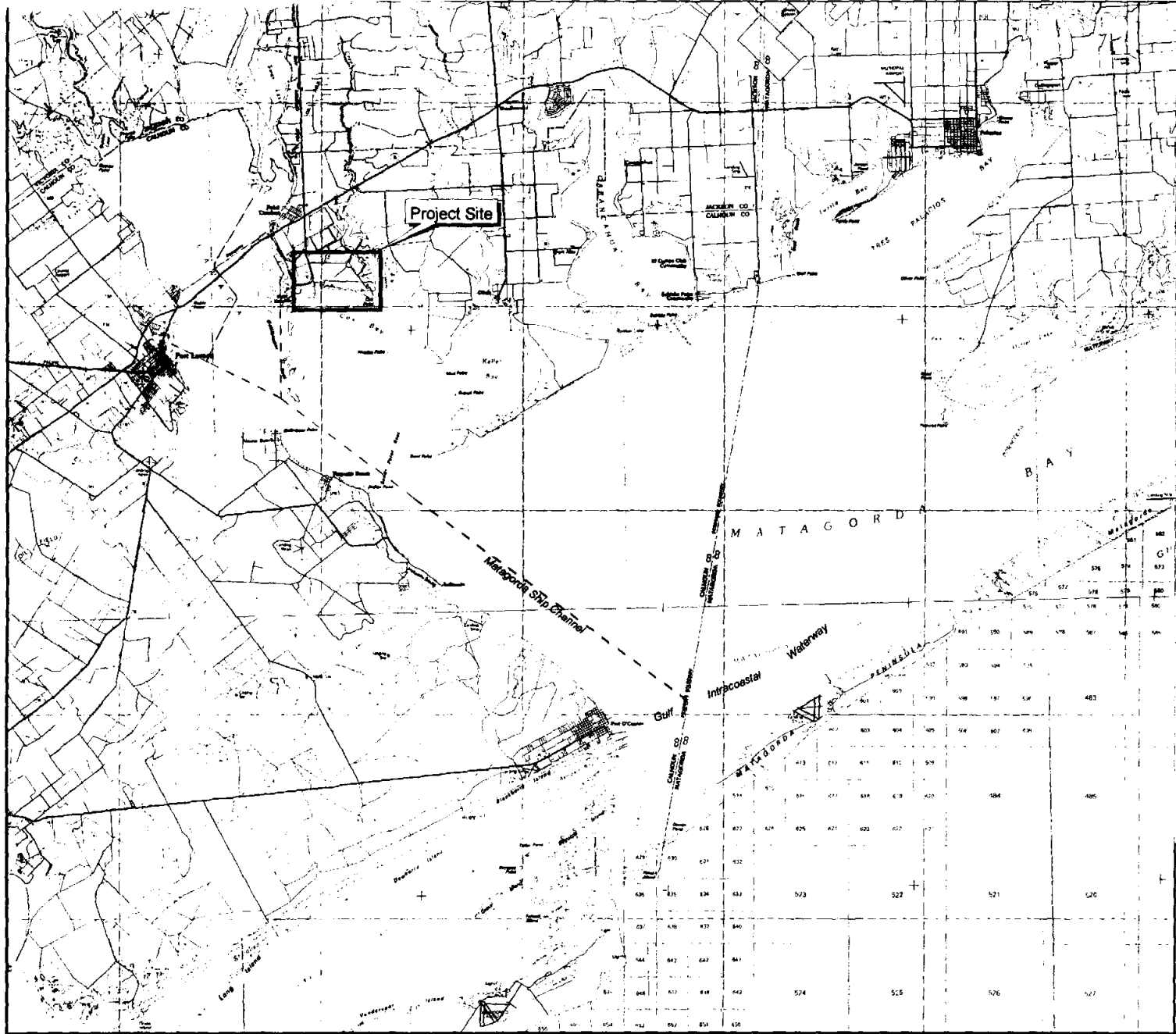

3 0 3 Miles

Basemap Source: Digital Raster Graphics (DRG), 100K, USGS
 Port Lavaca, Texas
 San Antonio Bay, Texas

Request For Contingency Funding TWDB Senate Bill 1 Planning Process Lavaca Regional Water Planning Group		
Vicinity Map		
TurnerCollie & Braden Inc. Engineers • Planners • Project Managers		
1	37-00600-002	June 2000

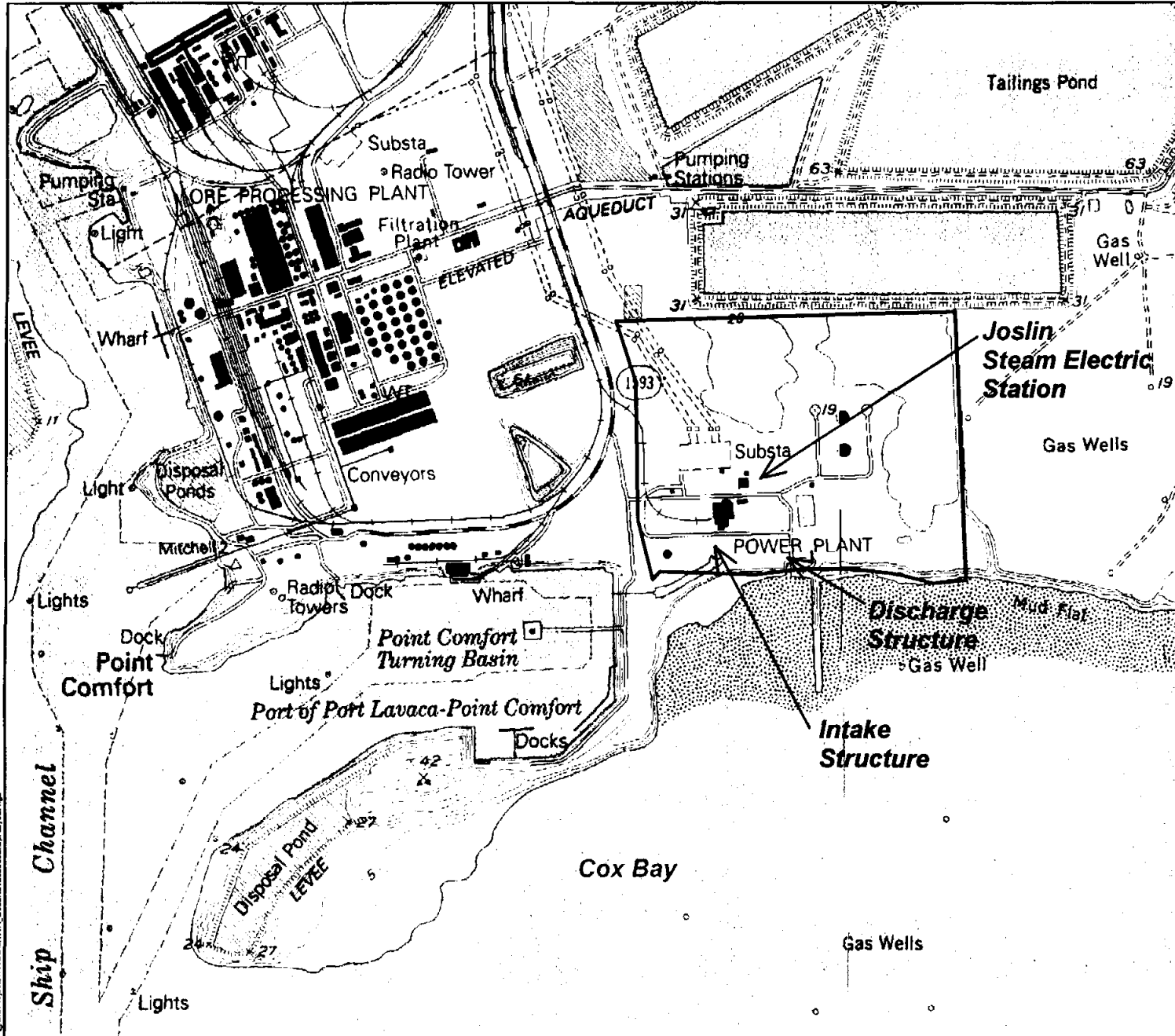

Legend

 **Boundary Line for Central Power & Light Co. (200 Ac.)**



1000 0 1000 Feet

Basemap Source: Digital Raster Graphics (DRG), 24K, USGS

Point Comfort, Texas

Request For Contingency Funding TWDB
Senate Bill 1 Planning Process
Lavaca Regional Water Planning Group

Location Map of
Joslin Steam Electric Station Site

TurnerCollie & Braden Inc.

Engineers • Planners • Project Managers

G:\Projects\TWDB\LRWA_Coastal\mxd\locmap.mxd

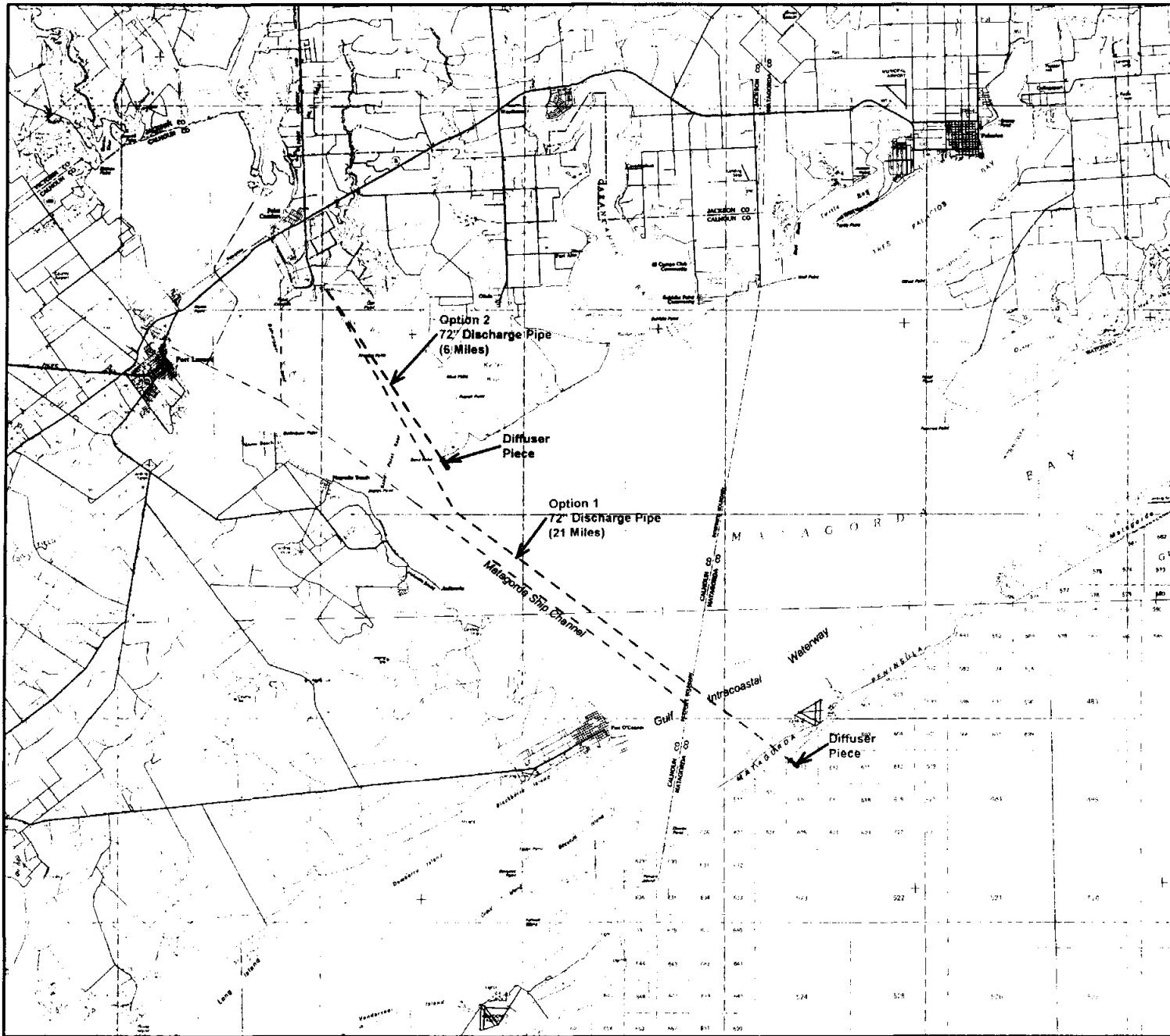

Legend

Option 1
 Discharge Pipe
 Diffuser Piece

Option 2
 Discharge Pipe
 Diffuser Piece



3 0 3 Miles

Basemap Source: Digital Raster Graphics (DRG), 100K, USGS

Port Lavaca, Texas
 San Antonio Bay, Texas

Request For Contingency Funding TWDB
 Senate Bill 1 Planning Process
 Lavaca Regional Water Planning Group

Options for
 Reject Water Disposal

TurnerCollie & Braden Inc.

Engineers • Planners • Project Managers

APPENDIX A

SITE EVALUATION AND DESALINATION PROCESS

16 June 2000

Mr. Mark Lowry
Turner Collie & Braden
P.O. Box 130089
Houston, TX 77219

Subject: Lavaca-Navidad River Authority
Seawater Desalination Plant

Dear Mr. Lowry:

USFilter is pleased to submit this letter report outlining the results of our investigation for siting a seawater desalination plant at the Joslin Power Station. You will note that we studied reverse osmosis (RO) and multiple effect distillation (MED) in both stand-alone and hybrid designs.

This study was based on a fuel cost of \$2.60/mmBtu and an electricity cost of \$0.04/kWh. Because significantly lower fuel costs could not be reliably obtained, a fuel sensitivity analysis was not conducted. We believe the costs presented herein are conservative and appropriate for planning purposes.

These costs are based on a conventional design followed by competitive bid and construction. In the event a design-build-operate scenario were chosen, the project costs could be expected to decrease approximately 10 to 15 percent.

It should be noted that these costs are based on the ability to discharge RO reject at the existing Joslin plant cooling water outfall, and do not include the cost of RO pretreatment sludge disposal.

TECHNICAL RESULTS

Introduction

This report presents the preliminary technical and economical results of the construction of seawater desalination facility for the Lavaca-Navidad River Authority. The plant would be located at Central Power and Light's (CP&L) Joslin Power Station in Point Comfort, Texas.

The intent of locating the desalination plant at this site is to take advantage of some existing power plant infrastructure.

It was also thought that the plant might be converted to dual-purpose facility in which two processes (power and water) could share the use of steam and reduce energy costs.

Due to the electric plant's low capacity factor (i.e. 35%), we investigated the additional benefit that might be gained by the inclusion of a hybrid desalination plant combining RO and MED. Our evaluation indicates that shared use of steam is not cost-effective at Joslin.

Five variations or options were analyzed for this study and the costs for each are included in this submittal. The Base Case is a stand-alone, 50 mgd, single-purpose RO plant that uses motor drives for the high pressure (HP) pumps. We have also considered a similar plant with 90 mgd production capacity.

Technical Discussion

Base Case

The base case RO process characteristics are summarized in Table 1. This case assumes that the RO plant uses variable speed drives for the high pressure pumps and electricity is purchased from the Joslin Plant at \$0.04 kWh. To meet the required production of 50 mgd, it is assumed that 11 trains will be required, each having a 5.0 mgd production capacity.

Case 1

This alternate considers an RO process which uses a steam turbine and a motor for driving the high pressure pumps. It assumes steam will be taken from the power plant whenever the power plant is not operating at full capacity. That is, this case assumes that when the power plant is operational, it does so at full capacity. Therefore, no steam is available for water production. However, for these periods the RO design incorporates the use of motor drives on the high pressure pumps in order to maintain water production. The process characteristics of this design are the same as that for the base case with the exception that the steam requirement from the power plant would be 349,770 lb/hr. This can be done because the existing power plant has an available steam flowrate design of 1,600,000 lb/hr. This case would require an 11 train RO plant. The process characteristics are summarized in Table 2.

Case 2

Case 2 assumes using the MED process at a performance ratio of 12 lbs/KBtu. For this case, the steam requirement would be on the order of 1,694,250 lb/hr, which is more than the boiler can produce. Thus, this case is not considered further.

Case 3

Case 3 considers using a hybrid plant which combines the RO and MED processes. This case assumes that an entirely new combined cycle power plant would be built with the desalting facility. The repowering of the existing plant would result in minimal benefit because for the repowering scheme, the existing steam turbine remains. Thus, no steam

is available for the desalting process, since the power plant would be on-stream continuously. This case would require approximately nine RO trains and two MED trains. The process characteristics are summarized in Table 3.

ECONOMICS

Cost Basis

The following assumptions were made in the preparation of these costs.

- Plant Location: Joslin Power Station
- Cost Year: Mid-2000
- Service Life: 30 years
- Interest: 6 percent
- Purchased Electricity Cost: \$0.04/kWh
- Joslin Power Station Electricity Cost: \$0.0381/kWh
- Steam Cost: Varies per case
- Land Cost: \$0.00
- Direct Labor Cost: \$12.00/hour (average all disciplines)
- Labor Overhead: 40 percent of direct labor
- Chemical Costs:
 - Chlorine \$0.20/lb
 - Sodium Bisulfite \$0.88/lb
 - Scale Inhibitor \$0.87/lb
 - Coagulant Aid \$0.10/lb
 - Cleaning Chemicals \$0.008/kgal
- Construction O/H and Profit: 8 % of total construction costs
- Owners' Costs: 7.5 % of total construction costs
- Contingency: 7.5 % of total construction costs
- Freight and Insurance: 5 % of total construction costs

- Taxes None

Components Included

Reverse Osmosis Process

The costs presented herein include the following equipment for this process:

- Feedwater supply piping
- Interconnecting feedwater supply piping and valves
- Coarse and dual media filtration pretreatment
- Chemical pretreatment systems
- Cartridge filters
- Process equipment, including all pumping services, energy recovery equipment membrane cleaning equipment, electrical distribution and instrumentation and controls.
- Building to house the control room, process equipment, chemical treatment, motor control center, offices and maintenance shop and warehouse
- Chemical post-treatment equipment
- High service pumping equipment
- Emergency generator
- Main step-down transformers
- Site development
- Concentrate disposal system

Multiple Effect Distillation

The costs presented herein include the following equipment for this process:

- Feedwater supply pumping
- Interconnecting feedwater supply piping and valves

- Chemical pretreatment equipment
- Process equipment, including all pumping services, brine heaters, heat rejection systems, electrical distribution and instrumentation and controls
- Building to house the control room, motor control center, offices, maintenance shop and warehousing
- Chemical post-treatment equipment
- High service pumping
- Emergency generator
- Main step-down transformers
- Site development
- Concentrate disposal system

The capital and operating costs for each case are summarized in Table 4.

CONCLUSIONS

The conclusions drawn from this study are:

- The most cost-effective process is the “stand alone” RO system. This process exhibits the lowest capital and operating cost and the lowest cost of water.
- Locating this process at the Joslin Power Station offers the following advantages:
 - a. The seawater intake exists and thus a new intake would not be required.
 - b. Sharing of operating staff
 - c. Sharing of maintenance staff
 - d. Sharing of workshop
 - e. Land for locating the plant would not have to be purchased.
 - f. The concentrate discharge from the desalting plant can use the existing cooling water outlet from the power plant.

g. Mixing the concentrate with the power plant outfall will reduce the outlet temperature of the power plant cooling water.

We appreciate the opportunity of working with you on this important project. If you have any questions, please do not hesitate to contact us at 281-986-3412.

Sincerely,

A handwritten signature in black ink that reads "Tom Pankratz". The signature is written in a cursive style with a large, prominent "T" and "P".

Tom Pankratz

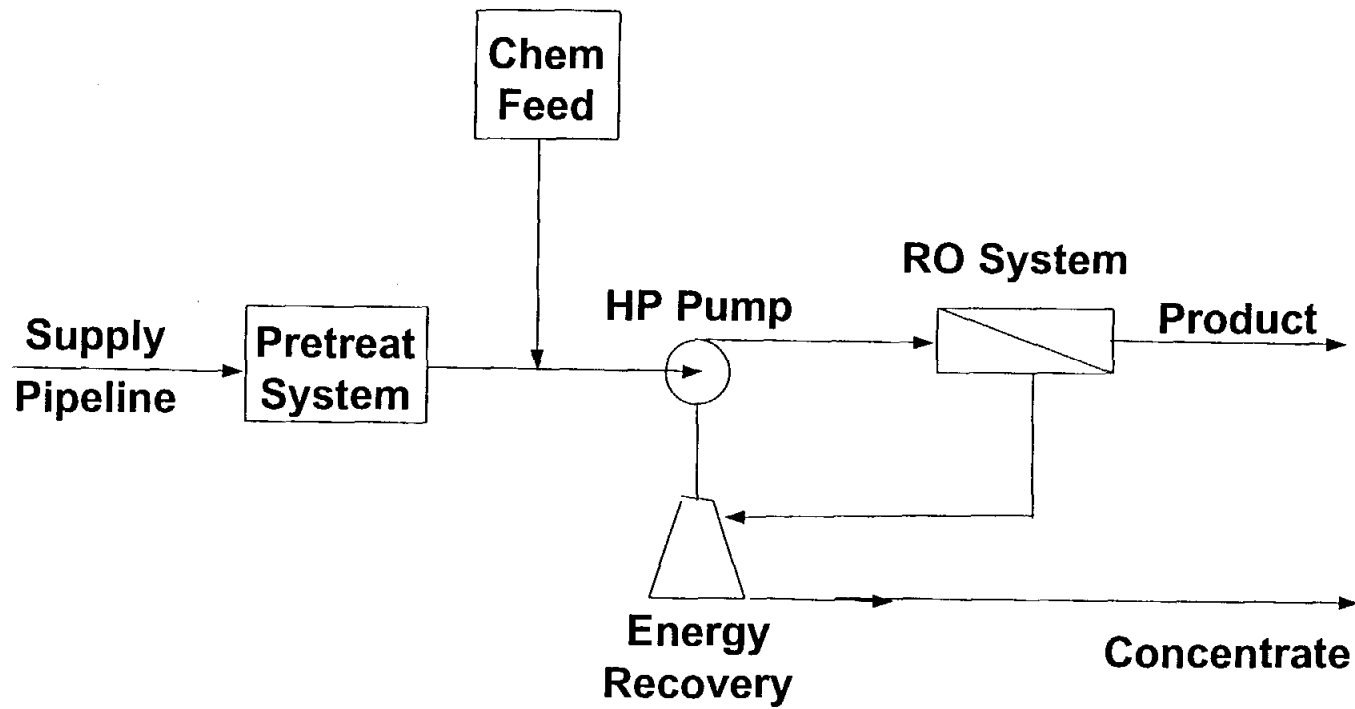

Base Case: Reverse Osmosis System

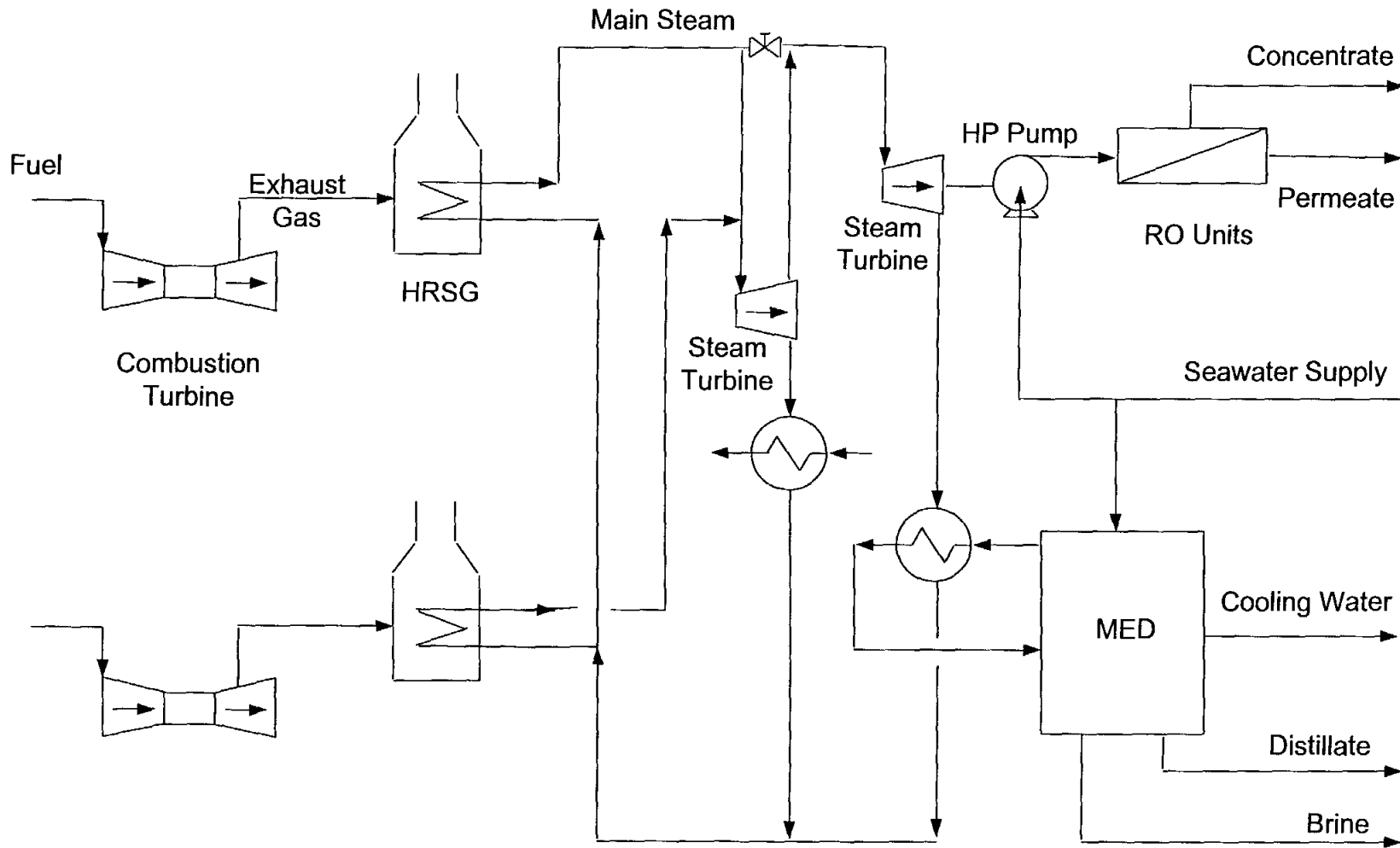

Case 3: Hybrid RO & MED Desalination System

Table 1**TECHNICAL CHARACTERISTICS
BASE CASE**

	<u>Per Train</u>	<u>Total</u>
<u>Flowrate (gpm)</u>		
Seawater supply	6,944	76,384
Permeate	3,472	38,194
Concentrate	3,472	38,194
<u>Pressures (psig)</u>		
Seawater supply	10	10
High pressure pump	758	758
Permeate	15	15
Concentrate	753	753
Seawater Supply Temperature (%F)	90	90
Connected Electrical Load (kW)	4,400	48,400
Specific Energy Consumption (kWh/kgal)	12.9	12.9
<u>Water Quality (mg/L)</u>		
Seawater supply	25,000	25,000
Permeate	283	283
Concentrate	49,641	49,641
Recovery (%)	50	50
Number of Units	1	11
Production Capacity (mgd)	5	55

Table 2**TECHNICAL CHARACTERISTICS
CASE 1**

	<u>Per Train</u>	<u>Total</u>
<u>Flowrate (gpm)</u>		
Seawater supply	6,944	76,384
Permeate	3,472	38,194
Concentrate	3,472	38,194
Steam Flow (lb/h)	41,717	458,890
<u>Pressures (psig)</u>		
Seawater supply	10	10
High pressure pump	758	758
Permeate	15	15
Concentrate	753	753
Steam pressure	250	250
Seawater Supply Temperature (%F)	90	90
Connected Electrical Load (kW)	4,400	48,400
Specific Energy Consumption		
Motor Drive (kWh/kgal)	12.9	12.9
Specific Energy Consumption		
Steam Drive (kWh/kgal)	3.39	3.39
<u>Water Quality (mg/L)</u>		
Seawater supply	25,000	25,000
Permeate	283	283
Concentrate	49,641	49,641
Recovery (%)	50	50
Number of Units	1	11
Production Capacity (mgd)	5	55

Table 3

**TECHNICAL CHARACTERISTICS
CASE 3**

	<u>RO Per Train</u>	<u>MED Per Train</u>	<u>RO Total</u>	<u>MED Total</u>	<u>Total</u>
<u>Flowrate (gpm)</u>					
Seawater supply	6,944	7,434	62,996	14,868	77,364
Permeate	3,472	3,472	31,248	6,944	38,192
Concentrate	3,472	3,962	31,248	7,924	39,172
Steam Supply	37,749	37,749	339,739	339,739	339,739
<u>Pressures (psig)</u>					
Seawater supply	10	10	10	10	-
High pressure pump	758	-	758	-	-
Permeate	15	0	15	0	-
Concentrate	753	0	753	0	-
Seawater Supply Temp (%F)	90	90	90	90	90
Connected Electrical Load (kW)	4,400	1,129	39,600	2,258	41,858
Specific Energy Consumption (kWh/kgal)	3.38	5.42	3.38	5.42	3.75
<u>Water Quality (mg/L)</u>					
Seawater supply	25,000	25,000	25,000		25,000
Permeate	283	25.0	283		199
Concentrate	49,641	50,000	49,641		49,706
Recovery (%)	50	46.7	50	46.7	49.4
Number of Units			9	2	11
Production Capacity (mgd)	5	5	45	10	55

Table 4
CAPITAL AND OPERATING COSTS
(First Year Costs)

<u>Case (flow)</u>	<u>Operating Capital Cost (\$)</u>	<u>Cost of Cost (k/gal)</u>	<u>Water (k/gal)</u>
Base (50 mgd)	160,906,500	1.24	1.89
Base (90 mgd)	195,448,100	1.15	1.75
1 (50 mgd)	174,610,000	1.33	2.29
2 (50 mgd)	Not studied		
3 (50 mgd)	196,918,000	1.25	2.29
3 (100 mgd)	288,743,271	1.20	2.08

APPENDIX A - 2

TURNER COLLIE & BRADEN INC.:
COMBINED FINAL COSTS,
REJECT WATER, AND DISPOSAL COSTS

TABLE A-2

Cost Estimating Worksheet

Garwood Pipeline-Off Channel Storage Option

ENR CCI Values

1999

6018

Estimated Costs

for Facilities

Updated to Second Quarter 1999

Item	Notes	Unit Cost	Quantity	Units	Outdated Cost	ENR CCI Ratio	1999 Updated Cost
Pumping Stations							
Reservoir Pump Station		4,044,300.0	1	LS			\$4,044,300
Intake		\$1,819,935	1	LS			\$1,819,935
Power Connection		125	3935	HP			\$491,875
River Pump Station		4,034,500.0	1	LS			\$4,034,500
Intake		\$1,815,525	1	LS			\$1,815,525
Power Connection		125	3019	HP			\$377,375
Booster Station 1				LS			\$0
Storage Tank for Booster				LS			\$0
Power Connection			0	HP			\$0
Booster Station 2				LS			\$0
Storage Tank for Booster				LS			\$0
Power Connection			0	HP			\$0
Booster Station 3				LS			\$0
Storage Tank for Booster				LS			\$0
Power Connection			0	HP			\$0
Piping							
42 in <= 150 psi		96	136,347	ft			\$13,089,312
42 in > 150 psi		108.5	51,487	ft			\$5,586,340
64 in <= 150 psi		165	31,333	ft			\$5,169,945
Texana Connection							
Valves		350000.00	1	LS			\$350,000
Piping		286200.00	1	LS			\$286,200
Vault and Excavation		259000.00	1	LS			\$259,000
Texana Connection at booster 1							
Valves		350000.00	1	LS			\$350,000
Piping		286200.00	1	LS			\$286,200
Vault and Excavation		259000.00	1	LS			\$259,000
Texana Pipeline Upgrade		1639000.00	1	LS			\$1,639,000
Highway and Stream Crossings							
Highway (tunneling)		791.81	750	ft	780.1	1.01501	\$593,857
Highway and Creek Crossings		98.56	1950	ft	97.1	1.01501	\$192,187
Directional Drilling		815.0	2,000	ft			\$1,630,000
Water Treatment Plant							
Treatment Level			1	LS			\$0
Dams and Reservoirs							
Off-Channel Reservoir		1,168.0	8,000.0	AcFt			\$9,344,000
Storage Tanks (other than at booster stations)							
Tank at Lake Texana			2.0	MG			\$1,129,300
Off Channel Storage							\$0
Well Fields							
				LS			\$0
				LS			\$0
				LS			\$0
Power Connection Costs				HP			\$0
Injection							\$0
Recovery							\$0
ASR Wells							\$0
Relocation							
Water Distribution System Improvements							
Other							
Access Road		203,002.0	2.00	mi	200,000	1.02	\$406,004
Total Capital Cost					\$200,877		\$53,153,855

TABLE A-2

Cost Estimating Worksheet

Garwood Pipeline-Off Channel Storage Option

ENR CCI Values		Estimated Costs					
1999	6018	for Facilities					
		Updated to Second Quarter 1999					
Item	Notes	Unit Cost	Quantity	Units	Outdated Cost	ENR CCI Ratio	1999 Updated Cost
Engineering, Legal Costs and Contingencies							
Pipeline Project		30%	43,809,855	\$			\$13,142,956
Reservoirs		35%	9,344,000	\$			\$3,270,400
All other Facilities		35%	0	\$			\$0
Land Acquisition							
Reservoir		1,000	580	acres			\$580,000
30' Right of Way				acres			\$0
40' Right of Way		10	219,167	ft			\$2,191,670
Storage Tanks				acres			\$0
Water Treatment Plant				acres			\$0
Wells				acres			\$0
Intake and Pump Station		800	6	acres			\$4,800
Booster Stations				acres			\$0
Reservoir Surveying		\$50	580	acres			\$29,000
Surveying		10%	2,196,470	\$			\$219,647
Environmental & Archaeology Studies and Mitigation							
Reservoir		100%	580,000	Land\$			\$580,000
Pipeline		\$25,000	42	Mile			\$1,037,723
Other		100%	4,800	Land\$			\$4,800
Purchase of Water Right							
Garwood Purchase		\$583		acft/yr			\$0
Reservoir Interest During Construction							
	Loan Rate	6.0%					
	Rate of Return on Investments	4.0%					
	Duration of Project (yr)	2					\$1,105,000
Remaining Interest During Construction							
	Loan Rate	6.0%					
	Rate of Return on Investments	4.0%					
	Duration of Project (yr)	2.0					\$4,833,000
Total Project Cost							\$80,152,850
Annual Costs							
Non-Reservoir Debt Service (6%, 30 years)		6.0%	30	yr			\$4,278,174
Reservoir Debt Service (6%, 40 years)		6.0%	40	yr			\$990,835
Pipeline, Tank, Distribution & Well O&M		1.0%	31,226,345	\$			\$312,263
Dam and Reservoir O&M		1.5%	9,344,000	\$			\$140,160
Intake and Pump Stations O&M		2.5%	12,583,510	\$			\$314,588
Water Treatment Plant O&M		0	0	LS			\$0
Pumping Energy Costs		\$0.06	12,358,022				\$741,481
Texana Pumping Energy		\$0.06	8,384,354	kW-hr			\$503,061
Well Pumping Energy Costs		\$0.06		kW-hr			\$0
Texana Pipeline Costs		\$30.00	35,000	acft/yr			\$1,050,000
Purchase of Water		\$46.00	35,000	acft			\$1,610,000
Total Annual Cost							\$9,940,563
Available Project Yield (acft/yr)			35,000	acft/yr			35,000
Annual Cost of Water (\$/acft)							\$284
Annual Cost of Water (\$/1000 gal)							\$0.87

TABLE A-3

Cost Estimating Worksheet

SCTN 16b (65,000 acft/yr from Guadalupe plus treat and transport to San Antonio 35,000 acft/yr from Garwood)

ENR CCI Values

1999 6018

Estimated Costs

for Facilities

Updated to Second Quarter 1999

Item	Notes	Unit Cost	Quantity	Units	Outdated Cost	ENR CCI Ratio	1999 Updated Cost
Pumping Stations							
Pump Station		6,908,000.0	1	LS			\$6,908,000
Intake							\$3,108,600
Power Connection		125	13,105	HP			\$1,638,159
Booster Station 1		5,777,000	1	LS			\$5,777,000
Storage Tank for Booster		1,918,000	1	LS			\$1,918,000
Power Connection		125	8061	HP			\$1,007,625
Booster Station 2		6,153,000	1	LS			\$6,153,000
Storage Tank for Booster		1,918,000	1	LS			\$1,918,000
Power Connection		125	9437	HP			\$1,179,625
SWB Diversion	251 cfs	5,180,000	1	LS			\$5,180,000
Storage Tank for Booster				LS			\$0
Power Connection		\$125	6326	HP			\$790,750
Piping							
	96" Diversion	317.0	66,672	ft			\$21,135,151
72"	Soil, Rural	218.0	288,321	ft			\$62,853,978
	High Pressure, Soil, Rural	246.0	210,095	ft			\$51,683,370
	Combination, Rural	272.0	85,147	ft			\$23,159,984
	Combination, Urban	422.0	33,452	ft			\$14,116,744
				ft			\$0
				ft			\$0
				ft			\$0
				ft			\$0
				ft			\$0
				ft			\$0
				ft			\$0
				ft			\$0
				ft			\$0
				ft			\$0
Highway and Stream Crossings							
	22 major road	\$ 1,344	3300	ft			\$4,435,200
	1 rail road	\$ 1,344	100	ft			\$134,400
	3 major streams	\$ 1,344	800	ft			\$1,075,200
Directional Drilling	Guadalupe River	1,008	1,387	ft			\$1,398,096
Water Treatment Plant	Treatment Level 3	56,100,000	1	LS			\$56,100,000
Dams and Reservoirs							
Off-Channel Reservoir	20,000 acft	13,626,000.0	1	LS			\$13,626,000
Storage Tanks (other than at booster stations)							
Well Fields							
				LS			\$0
				LS			\$0
				LS			\$0
Power Connection Costs		\$125		HP			\$0
Injection							\$0
Recovery							\$0
ASR Wells							\$0
Relocation							
Water Distribution System Improvements		1,288,000	50	MGD			\$64,400,000
		758,000	39.3	MGD			\$29,789,400
Stilling Basin		2,764.0	251	cfs			\$693,764
Total Capital Cost						\$0	\$380,180,046
Engineering, Legal Costs and Contingencies							
Pipeline Project		30%	179,992,123	\$			\$53,997,637
Reservoirs		35%	13,626,000	\$			\$4,769,100
All other Facilities		35%	186,561,923	\$			\$65,296,673
Land Acquisition							

TABLE A-3

Cost Estimating Worksheet

SCTN 16b (65,000 acft/yr from Guadalupe plus treat and transport to San Antonio 35,000 acft/yr from Garwood)

ENR CCI Values

Estimated Costs

1999

6018

for Facilities

Updated to Second Quarter 1999

Item	Notes	Unit Cost	Quantity	Units	Outdated Cost	ENR CCI Ratio	1999 Updated Cost
Reservoir		1,300	1,218	acres			\$1,583,400
30' Right of Way		8,712		acres			\$0
40' Right of Way		8,712	628	acres			\$5,469,499
Storage Tanks		1,300	4	acres			\$5,200
Water Treatment Plant		1,300	15	acres			\$19,251
Wells		1,300		acres			\$0
Intake and Pump Station		1,300	4	acres			\$5,200
Booster Stations		13	4	acres			\$52
Reservoir Surveying		\$50	1,218	acres			\$60,900
Surveying		10%	5,499,202	\$			\$549,920
Environmental & Archaeology Studies and Mitigation							
Reservoir		100%	1,583,400	Land\$			\$1,583,400
Pipeline		\$25,000	129	Mile			\$3,237,156
Other		100%	29,703	Land\$			\$29,703
Reservoir Interest During Construction							
	Loan Rate	6.0%					
	Rate of Return on Investments	4.0%					
	Duration of Project (yr)	2					\$1,730,000
Remaining Interest During Construction							
	Loan Rate	6.0%					
	Rate of Return on Investments	4.0%					
	Duration of Project (yr)	2					\$39,614,000
Total Project Cost							\$558,131,137
Annual Costs							
Non-Reservoir Debt Service (6%, 30 years)		6.0%	30	yr			\$38,851,064
Reservoir Debt Service (6%, 40 years)		6.0%	40	yr			\$1,552,063
Pipeline, Tank, Distribution & Well O&M		1.0%	278,711,287	\$			\$2,787,113
Dam and Reservoir O&M		1.5%	13,626,000	\$			\$204,390
Intake and Pump Stations O&M		2.5%	31,742,759	\$			\$793,569
Water Treatment Plant O&M		7,076,000	1	LS			\$7,076,000
Pumping Energy Costs		\$0.06	204,175,561	kW-hr			\$12,250,534
Well Pumping Energy Costs		\$0.06		kW-hr			\$0
Purchase of Water		\$61.00	65,000	acft			\$3,965,000
Annual Cost							67,479,733
Annual Cost (Garwood)							\$9,940,563
Total Annual Cost							\$77,420,295
Available Project Yield (acft/yr)				acft/yr			100,000
Annual Cost of Water (\$/acft)							\$774
Annual Cost of Water (\$/1000 gal)							\$2.38

TABLE A-4

Cost Estimating Worksheet

LNRA 1b (65,000 acft/yr from Guadalupe, 35,000 acft/yr from Garwood, plus 100,000 acft/yr from Joslin)

ENR CCI Values		Estimated Costs					
1999	6018	for Facilities					
		Updated to Second Quarter 1999					
Item	Notes	Unit Cost	Quantity	Units	Outdated Cost	ENR CCI Ratio	1999 Updated Cost
Pumping Stations							
Pump Station at Joslin (Point Comfort) 89.3 mgd		5,198,000.0	1	LS			\$5,198,000
Intake			1				
Power Connection		125	6,367	HP			\$795,867
Pump Station at Bloomington 178.6 mgd		8,737,000.0	1	LS			\$8,737,000
Intake							\$3,931,650
Power Connection		125	26,211	HP			\$3,276,318
Booster Station 1		7,426,000	1	LS			\$7,426,000
Storage Tank for Booster		3,282,000	1	LS			\$3,282,000
Power Connection		125	16122	HP			\$2,015,250
Booster Station 2		7,784,000	1	LS			\$7,784,000
Storage Tank for Booster		3,282,000	1	LS			\$3,282,000
Power Connection		125	18874	HP			\$2,359,250
SWB Diversion	251 cfs	5,180,000	1	LS			\$5,180,000
Storage Tank for Booster				LS			\$0
Power Connection		\$125	6326	HP			\$790,750
Piping							
	96" Diversion	317.0	66,672	ft			\$21,135,151
72"	Soil, Rural	218.0	785,320	ft			\$171,199,760
	High Pressure, Soil, Rural	246.0	420,190	ft			\$103,366,740
	Combination, Rural	272.0	170,294	ft			\$46,319,968
	Combination, Urban	422.0	66,904	ft			\$28,233,488
				ft			\$0
				ft			\$0
				ft			\$0
				ft			\$0
				ft			\$0
				ft			\$0
				ft			\$0
Highway and Stream Crossings							
	22 major road	\$ 1,344	6600	ft			\$8,870,400
	1 rail road	\$ 1,344	200	ft			\$268,800
	3 major streams	\$ 1,344	2200	ft			\$2,956,800
Directional Drilling	Guadalupe River	1,008	2,774	ft			\$2,796,192
Water Treatment Plant	Treatment Level 3 and Desal	56,100,000	1	LS			\$251,548,100
Dams and Reservoirs				LS			\$0
Off-Channel Reservoir	20,000 acft	13,626,000.0	1	LS			\$13,626,000
Storage Tanks (other than at booster stations)			0	MG			\$0
Well Fields							
				LS			\$0
				LS			\$0
				LS			\$0
Power Connection Costs		\$125		HP			\$0
Injection							\$0
Recovery							\$0
ASR Wells							\$0
Relocation							
Water Distribution System Improvements		1,288,000	50	MGD			\$64,400,000
		758,000	128.6	MGD			\$97,478,800
Stilling Basin		2,764.0	251	cfs			\$693,764
Total Capital Cost						\$0	\$866,952,048
Engineering, Legal Costs and Contingencies							
Pipeline Project		30%	385,147,299	\$			\$115,544,190
Reservoirs		35%	13,626,000	\$			\$4,769,100
All other Facilities		35%	468,178,749	\$			\$163,862,562

TABLE A-4

Cost Estimating Worksheet

LNRA 1b (65,000 acft/yr from Guadalupe, 35,000 acft/yr from Garwood, plus 100,000 acft/yr from Joslin)

ENR CCI Values		Estimated Costs				
1999	6018	for Facilities				
Updated to Second Quarter 1999						
Item	Notes	Unit Cost	Quantity	Units	Outdated Cost	ENR CCI Ratio
Facility						1999 Updated Cost
Land Acquisition						
Reservoir		1,300	1,218	acres		\$1,583,400
60' Right of Way	Combined 60' ROW	8,712	850	acres		\$7,404,180
40' Right of Way			253	acres		\$0
Storage Tanks		1,300	6	acres		\$7,800
Water Treatment Plant		1,300	15	acres		\$19,251
Wells		1,300		acres		\$0
Intake and Pump Station		1,300	4	acres		\$5,200
Booster Stations		13	6	acres		\$78
Reservoir Surveying		\$50	1,218	acres		\$60,900
Surveying(including Joslin Site)		10%	7,446,509	\$		\$744,651
Environmental & Archaeology Studies and Mitigation						
Reservoir		100%	1,583,400	Land\$		\$1,583,400
Pipeline		\$25,000	168	Mile		\$4,206,186
Other		100%	32,329	Land\$		\$32,329
Reservoir Interest During Construction						
	Loan Rate	6.0%				
	Rate of Return on Investments	4.0%				
	Duration of Project (yr)	2				\$1,730,000
Remaining Interest During Construction						
	Loan Rate	6.0%				
	Rate of Return on Investments	4.0%				
	Duration of Project (yr)	2				\$91,613,000
Total Project Cost						\$1,260,118,274
Annual Costs						
	Non-Reservoir Debt Service (6%, 30 years)	6.0%	30	yr		\$89,849,665
	Reservoir Debt Service (6%, 40 years)	6.0%	40	yr		\$1,552,063
	Pipeline, Tank, Distribution & Well O&M	1.0%	554,283,863	\$		\$5,542,839
	Dam and Reservoir O&M	1.5%	13,626,000	\$		\$204,390
	Intake and Pump Stations O&M	2.5%	47,494,085	\$		\$1,187,352
	Water Treatment Plant & Desal Plant O&M	7,076,000	1	LS		\$27,979,328
	Pumping Energy Costs	\$0.06	433,858,777	kW-hr		\$26,031,527
	Desal Plant Energy Costs	\$0.04	414,091,800	kW-hr		\$16,563,672
	Purchase of Water	\$61.00	65,000	acft		\$3,965,000
Annual Cost						172,875,836
Annual Cost (Garwood)						\$9,940,563
Total Annual Cost						\$182,816,399
Available Project Yield (acft/yr)				acft/yr		200,000
Annual Cost of Water (\$/acft)						\$914
Annual Cost of Water (\$/1000 gal)						\$2.80

TABLE A-5

PROBABLE COSTS FOR DISPOSAL OF SOLIDS FROM DESALINATION PLANT

Assuming 22 Percent Solids in Filter Cake	mgd	lbs. sludge/ million lbs raw water	lbs. sludge/ day	
<i>CASE 1 (50 mg/l)</i>				
Daily Sludge =	180	50	75,060	
Annual Sludge =			27,396,900	lbs. dry solids
Annual Sludge (22% dewatered solids) =			62,266	tons wet solids
Annual Sludge (20 tons/load) =			3,113	truckloads of wet solids hauled per year
Disposal Cost @ \$31/ton =			\$620	per truckload
Disposal + Hauling Cost =			\$720	per truckload & hauled
Annual cost =			\$2,241,565	

<i>CASE 2 (100 mg/l)</i>				
Daily Sludge =	180	100	150,120	
Annual Sludge =			54,793,800	lbs. dry solids
Annual Sludge (22% dewatered solids) =			124,531	tons wet solids
Annual Sludge (20 tons/load) =			6,227	truckloads of wet solids hauled per year
Disposal Cost @ \$31/ton =			\$620	per truckload
Disposal + Hauling Cost =			\$720	per truckload & hauled
Annual cost =			\$4,483,129	

22 PERCENT SOLIDS IN FILTER CAKE				
Process		Annual Cost	Annual Cost per 1000 gallons	
			100,000 ac-ft	200,000 ac-ft
Case 1		\$2,242,000	\$0.07	\$0.03
Case 2		\$4,483,000	\$0.14	\$0.07

**TABLE A-6 PROBABLE COSTS FOR REJECT WATER
DISPOSAL TO MATAGORDA BAY**

Capital Cost		Cost
Pump Station		\$4,200,000
Pipeline		\$22,600,000
Total Capital Cost		\$26,800,000
Annual Cost		
Electricity		\$360,000
Operation		\$226,000
Maintenance		\$105,000
Total Annualized Debt Service (1)		\$1,947,000
Total Annualized Cost		\$2,638,000
Annual Cost Per Unit of Water		
Volume of Reject Water (ac-ft)	Cost per ac-ft	Cost per 1000 gallons
100,000	\$26.38	\$0.08
200,000	\$13.19	\$0.04

(1) Assuming a 6 percent interest rate over 30 years.

**TABLE A-7 PROBABLE COSTS FOR REJECT WATER
DISPOSAL TO GULF OF MEXICO**

Capital Cost		Cost
Pump Station		\$7,400,000
Pipeline		\$74,800,000
Total Capital Cost		\$82,200,000
Annual Cost		
Electricity		\$1,270,000
Operation		\$748,000
Maintenance		\$185,000
Total Annualized Debt Service (1)		\$5,972,000
Total Annualized Cost		\$8,175,000
Annual Cost Per Unit of Water		
Volume of Reject Water (ac-ft)	Cost per ac-ft	Cost per 1000 gallons
100,000	\$81.75	\$0.25
200,000	\$40.88	\$0.13

(1) Assuming a 6 percent interest rate over 30 years.

APPENDIX B

DESALINATION PLANT ENVIRONMENTAL ISSUES

MEMORANDUM

TO: Mark Lowry, Turner Collie & Braden FROM: George H. Ward
COPY: Jack C. Nelson, LNRA DATE: 18 June 2000
Tom Pankratz, USFilter

Environmental aspects of proposed Lavaca Bay desalination plant

1. Introduction

The project under consideration is the co-siting and coordinated operation of a desalination plant with the Joslin Steam Electric Station, located on Lavaca Bay near Point Comfort. The Joslin Plant is presently owned and operated by Central Power & Light (CP&L) of Corpus Christi. The proposed desalination plant would produce water for distribution by the Lavaca-Navidad River Authority (LNRA).

This memorandum documents preliminary reviews of the environmental aspects of the proposed plant, related to the aquatic system of Lavaca Bay. The objectives of the present review are:

- (1) identify and characterize the hydrographic and water quality features of the Lavaca Bay environment that have significant interactions with the proposed desalination plant
- (2) estimate the impacts of the desalination plant operation (and its various alternatives) on the hydrography and water quality of Lavaca Bay and Matagorda Bay, and consider mixing requirements for the outfall in each option
- (3) identify the principal environmental impacts of the proposed operation on the aquatic system of Lavaca Bay and Matagorda Bay, and identify which impacts, if any, will warrant major environmental studies prior to permitting and construction of the plant

(4) identify any "fatal-flaw" environmental consequences of any of the alternative desalination plant strategies.

(5) detailing the advantages and disadvantages of each option and the recommended disposal method, from the standpoint of the aquatic environment.

In the course of preparing this review, this writer:

(1) reviewed the existing discharge permit for the Central Power & Light (CP&L) Joslin Power Plant, and the associated biological effects investigations and heat budget studies with respect to the impacts of the present cooling water discharge;

(2) reviewed the discharge volumes and salinity estimates for reject water from the proposed desalination plant;

(3) considered potential environmental issues with regard to residuals disposal, based upon preliminary design information provided by TC&B and USFilter;

(4) estimated the environmental impacts of the discharge of the desalination reject water considering three alternative disposal strategies:

- (i) into Lavaca Bay through the existing cooling water outfall structure.
- (ii) into Matagorda Bay through a new pipeline and outfall structure
- (iii) into the Gulf of Mexico through a new pipeline

(5) considered issues of mixing requirements for the outfalls for each option;

(6) in conjunction with staffs of TC&B, USFilter, CP&L, and LNRA, addressed regulatory obstacles to residuals disposal.

2. Hydrographic setting: Matagorda and Lavaca Bay

Matagorda Bay is one of the principal embayments of the Texas coast. The overall Matagorda Bay system is depicted in Figure 1. Typical of many Gulf of Mexico estuaries, Matagorda Bay is a complex lagoonal system, nearly isolated from the sea by barrier islands and fed by several rivers and tributaries. Communication with the Gulf of Mexico occurs through two inlets, both located in the southern extremity of the system: Pass Cavallo, the natural main tidal inlet to the bay, and the Matagorda Entrance Channel landcut, which is a jettied artificial inlet crossing Matagorda Peninsula 5 km from Decrows Point at Pass Cavallo.

The total surface area of Matagorda Bay is about 1200 km² (with the 140 km² of East Bay included), making it the second largest of the Texas bays after Galveston; Lavaca Bay comprises

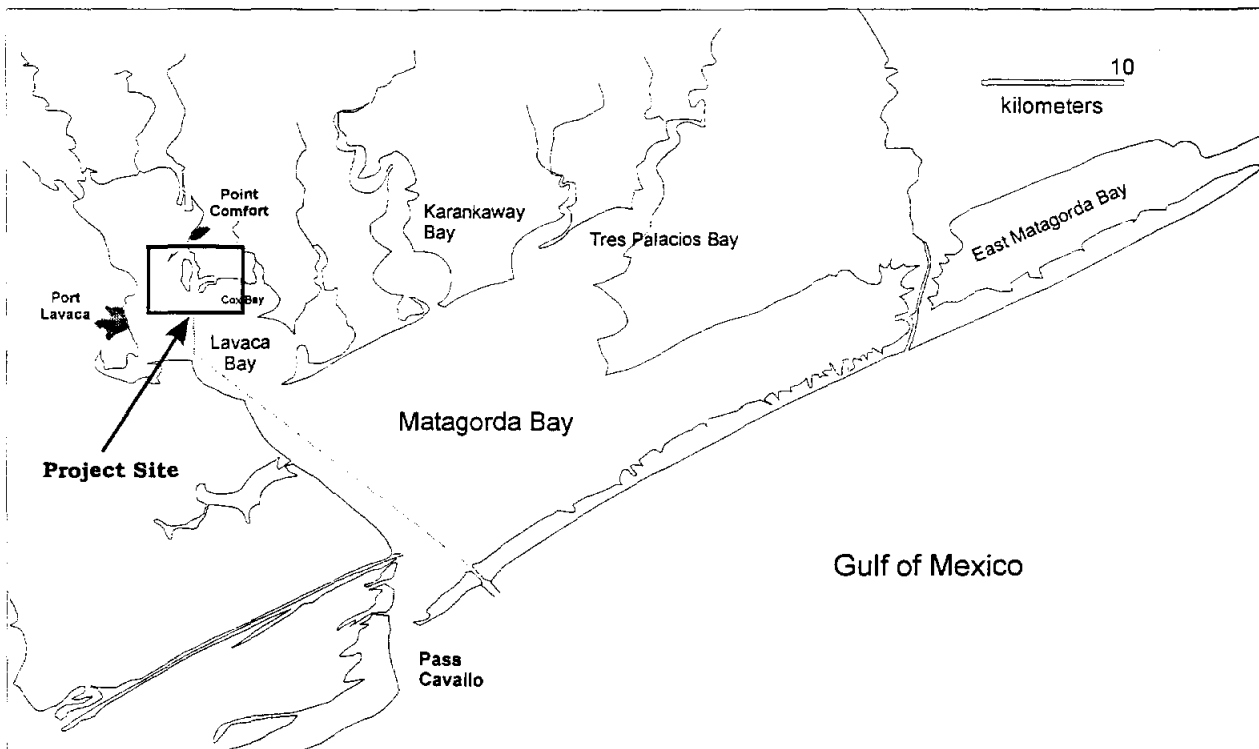

Figure 1 - Location map of Matagorda Bay

15 % of this area, some 190 km². The greatest natural water depths are found in the main body of Matagorda Bay where depths range 2 to 5 meters at low water, and average about 3 meters. The secondary bays (including Lavaca Bay) and the eastern arm are much shallower, averaging about half this depth.

While in many respects the hydrography of Lavaca Bay is intimately coupled to that of the larger Matagorda system, Lavaca Bay also exhibits a degree of autonomy due to its morphological separation from the Matagorda Bay system and to the fact that it receives a major portion of the freshwater inflow into the bay. It is the site of the single most important marsh system in the bay (and one of the larger deltaic-marsh complexes on the Texas coast), and is an important nursery habitat. It is also the focus of most of the industrial development on the Matagorda Bay periphery. The Lavaca-Navidad river system debouches into the northeastern corner of Lavaca Bay. There is a concrete-pier causeway crossing the bay from Port Lavaca to Point Comfort, which forms a natural boundary subdividing the bay into Upper Lavaca Bay and Lower Lavaca Bay. The connection between Lavaca Bay and Matagorda Bay is a relatively constricted pass, spanned by the Sand Point Reef complex.

Like most of the Texas bays, Matagorda is transected by ship channels. In addition to the Gulf Intracoastal Waterway (GIWW) and several barge channels, the bay is crossed by a deepdraft ship channel, the Matagorda Ship Channel, which enters the bay through the Entrance Channel landcut, crosses the Bay on a NW-SE line into Lavaca Bay, finally terminating at Point Comfort (Fig. 1). This channel was dredged in 1962-63 to a depth of 11 m (36 ft).

2.1 Hydrographic controls and circulation

The Matagorda Bay system is a type of estuary, a complex and extraordinarily productive coastal water body, see Ward and Montague (1997). By definition, an estuary is a transitional zone between the freshwater and oceanic environments, and therefore is influenced by both terrestrial and marine factors, and exhibits a gradient between domination by one to the other. This is true

in particular of Matagorda Bay, and implies a complex hydrodynamic system whose description is facilitated by considering those factors most important to its circulation.

Clearly, morphology, especially bathymetry, is one of the principal controlling factors, especially given the broad shallow nature of the bay. Matagorda Bay is in fact a lagoonal estuary (Ward and Montague, 1997). Matagorda Bay, and *a fortiori* Lavaca Bay, are practically two-dimensional systems, with the principal circulations and variation of parameters occurring in the horizontal plane. Moreover, the reefs, peninsulas, and prominences of the shoreline all serve as hydrodynamic barriers, forcing or reinforcing preferential trajectories of water movement. In addition, there are four sources of external forcing of greatest importance in the hydrodynamic behavior of Matagorda Bay: tides, meteorology, freshwater inflow, and density currents.

Tides refer to the sea-level variations arising from astronomical effects, i.e. the gravitational interactions of the earth-moon-sun system. By the nature of the way tidal variation is analyzed, some additional periodic components that are not (necessarily) gravitational in origin, become part of the signal, notably the 24-hour and 6-month (secular) variations. The tide is probably the most obvious marine influence in an estuary. In the Gulf of Mexico, however, the tide—the astronomical tide, that is— is feeble, in part due to the filtering of tidal energy upon propagation from the Atlantic through the Strait of Florida. To a first approximation, the Gulf seafront tide can be considered a superposition of a 12.4-hour semidiurnal and 24.8-hour diurnal tide, the latter modulated by a 27.2-day period arising from the declination of the moon (which produces an approximately fortnightly periodicity), all of which is superposed on a long-term "secular" semi-annual rise and fall (see, e.g., Ward, 1997). The maximum diurnal range of the tide along Matagorda Peninsula is something over a meter.

This Gulf tide is considerably modified as it passes through the inlets into the Matagorda Bay system, a manifestation of the "stilling well" effect (Ward, 1997). Fundamentally, Matagorda Bay can be considered a shallow basin connected by an *ajutage* with a much larger basin, the Gulf of Mexico, the two in co-oscillation. Much of the dynamics of the system can be explicated by this conceptual model. The tidal variation in the larger basin (the Gulf) drives the water level in the smaller (the bay), but the hydraulic capacity of the connecting inlet (the combination of

Pass Cavallo and the Entrance Channel) limits how fast the smaller basin can respond to water-level variations in the larger: the inlet acts as a filter for the higher frequency oscillations, exactly as a stilling well operates to filter out the effects of short-period waves. The 24.8-hr diurnal tide loses about 75% of its energy in passing through the inlets, and the 12.4-hr semidiurnal tide loses nearly 90% of its energy. The effect is a considerably reduced tidal range at these frequencies within the bay. As the tide further passes from the main body of Matagorda Bay into the secondary Lavaca Bay through the ajutage of the entrance at Sand Point, its semidiurnal and diurnal variations are reduced even further in amplitude.

The longer period fortnightly tide and the semidiurnal secular tide, in contrast, are hardly affected upon propagation into Matagorda Bay, and it is the water-level variation at these periods that produces much of the routine water exchange in the system. The secular variation is particularly important over the long term. A "normal" variation includes prominent water-level maxima in spring and fall, and minima in winter and summer. However, there are considerable year-to-year differences (hence the term "secular").

Meteorology means the circulations and fluxes forced by interaction of the bay with the overlying atmosphere. Matagorda Bay is in fact meteorologically dominated. The single most important meteorological agent is the wind, or, more precisely, the time change in wind. The wind regime in the Texas coastal zone can be simply characterized as a sustained onshore flow from the Gulf of Mexico, interrupted by frontal passages, and modulated by the sea-land breeze circulation. The Matagorda Bay area is subject to storm systems evolving from disturbances in the westerlies, and to tropical storms originating primarily over the tropical Atlantic. The most dramatic manifestation of the former is the bay's response to frontal passages. A typical scenario is as follows. As the front approaches the coast from the Great Plains, low-level convergence into the frontal zone enhances the normal onshore (southeasterly) winds. The onshore wind stress builds up water levels along the Gulf beachfront and along inshore segments of the bay. Then with the passage of the front, winds shift abruptly to the north and freshen, forcing the waters of the bay from the northern to the southern segments and through the inlets into the Gulf of Mexico. Water levels drop quickly, referred to as "set-down", and the associated currents can

become quite swift. Once the north winds "release," water from the Gulf surges back through the inlets, raising the water levels in the bay.

Approximately 52 such frontal passages occur each year, on the average (Morgan et al., 1975). Ward (1997) distinguished two types of frontal passage, the equinoctial and the polar-outbreak. Equinoctial frontal passages effect a pronounced wind shift, but do not substantially affect water levels in the adjacent Gulf of Mexico. There are about 40 of these fronts every year in the bay region. (Despite the name, nothing is implied about seasonality, as these can occur in winter, and even—rarely—in summer.) Polar outbreak fronts are primarily, but not exclusively, a phenomenon of winter, and differ from the equinoctial fronts in accomplishing a much more dramatic impact on the coastal waters. These are the events that produce the major set-up and set-down responses characteristic of intense "northers." In the Matagorda Bay area, the number of such events in a year is highly variable, but is usually five to ten. Ward (1980) concluded that the frontal response of the Gulf of Mexico is the single most important factor determining the response of the Texas bays, the estuary being indirectly forced by the response of the Gulf (see also Ward, 1997). Direct windstress on the bay and the inverse-barometer response make secondary contributions to the response of the estuary. The largest proportion of volume exchange for Corpus Christi Bay was found by Ward (1997) to be about 10% of the bay volume, whereas the more energetic fronts evacuate 3-5 times this relative volume from Sabine Lake and Galveston Bay on the upper Texas coast. No specific analyses have been carried out for Matagorda Bay, but the tide data compiled in Ward and Armstrong (1980) indicated a response much like that of Galveston Bay, for which the volume of water exchanged between the Gulf and the bay is on the order of, and generally exceeds, the normal tidal prism..

Fronts are dramatic wind-shift events that occur irregularly in time. In contrast, the seabreeze is a cyclic variation in wind that is most pronounced under stable, constant weather conditions. The seabreeze cycle is ultimately caused by the difference in thermodynamics of seawater and land surface, and is most pronounced along their boundary, i.e. the coastline. It is a solenoidal circulation produced by the diurnal variation in density of the lower atmosphere resulting from the surface temperature differential of the land and sea (Haltiner and Martin, 1957). In the coastal zone itself, the seabreeze is manifested as a diurnal variation in wind velocity superposed

on the normal onshore flow from the Gulf of Mexico. The seabreeze is best developed in conditions typical of summer. As the seabreeze circulation intensifies during the day, frequently a frontal boundary is formed, along which develop thunderstorm cells. This appears to be an important source of summer rainfall on the watersheds of the Lavaca and Navidad.

Freshwater inflow is perhaps the defining characteristic of the estuary, not only entailing a means of dilution of seawater but also of influxes of nutrients and solids derived from terrestrial sources. The principal inflow to Lavaca Bay is the Lavaca River, or, more precisely, the confluence of the Lavaca and Navidad Rivers, which represents about 70% of the inflow in Lavaca Bay. This is also the most important single inflow to Matagorda Bay, except for the Colorado River.

Two extensive compilations of hydrological data for Matagorda Bay exist in the published literature: the U.S. Fish & Wildlife Matagorda Bay Study (Ward and Armstrong, 1980) and the Texas Water Development Board Bays & Estuaries Program (TDWR, 1980). There are two primary differences between them. First, Ward and Armstrong (1980) use the available period of record (through about 1978) for each of their flow statistics, while the TWDB uses the period 1941-77. Second, the two differ in the methodology for determining ungauged flows. The TWDB utilized Soil Conservation Service curve-number runoff estimates in a statistical model. Ward and Armstrong use extrapolation by drainage area for those watersheds with a USGS station in the lower basin, and the Thornthwaite surface-water-budget method (Thornthwaite and Mather, 1955) for watersheds without a satisfactory streamflow gauge record. The long-term mean inflows are summarized in Table 1, based upon these two sources.

For most of the Twentieth Century, the Colorado has played a rather equivocal role as a freshwater source to Matagorda Bay. Since 1990, a diversion channel has directed the entirety of the river flow into Matagorda Bay (see following section). Of course, since the Colorado enters the system at the farthest extreme from Lavaca Bay, it would have negligible direct effect on Lavaca Bay. Rather, its importance would derive from the indirect effect of altered salinities and water chemistry within the main body of Matagorda Bay adjacent to the entrance to Lavaca Bay.

Table 2 tabulates the mean annual pattern of monthly flows for the three principal gauged inflows, Lavaca, Navidad, and Colorado. The same basic annual pattern is exhibited by each of these, differing only in scale. In general, in the average year (whatever that is), there is a flood and a drought, the flood being the spring freshet and the drought being the late summer low-flow period. On average the monthly flows for these two extrema differ about a factor of five. However, this does not completely characterize the differences between the two flow regimes. Precipitation in these basins is dominated by deep convection, i.e. thunderstorms, which means the resulting runoff is flashy. The spring freshet in particular is usually a series of isolated rise events superposed on a base flow, rather than a general seasonal elevation in river flow. The coastal zone has a bimodal seasonal pattern of precipitation, with maximum precipitation in the equinoctial seasons, the fall maximum exceeding the spring, but with distance inland, the fall maximum diminishes in importance relative to the spring, which dominates the annual pattern for interior stations. Because of its flashy character, streamflow tends to be highly skewed. Also, the Navidad, having a more coastal watershed, has a bimodal seasonal distribution, tracking the bimodality of precipitation.

The Colorado River is a highly regulated system. Over 95% of the total drainage area of the basin is impounded, primarily by the Highland Lakes. More directly pertinent to Lavaca Bay, on the Navidad, Lake Texana (Palmetto Bend Dam) began deliberate impoundment in 1980. This is a large 1.7×10^5 ac-ft water-supply reservoir, whose drainage area of 1404 mi^2 is 98% of that of

Table 1
Annual-mean inflows into Lavaca Bay and Matagorda Bay
(cubic feet per second)

<i>bay</i>	<i>watershed</i>	<i>gauged flow</i>	<i>flow into bay</i>
	<i>Ward and Armstrong (1980)</i>		
Lavaca	Lavaca	316	338
	Navidad	559	727
	Garcitas	49	187
	Placedo	62	115
	Venado Creek		36
	Cox Bay		54
	Chocolate Bay		51
	Keller Bay		66
	East Sheriff Oil Field		41
Lavaca Bay total		986	1615
Tres Palacios		143	230
Matagorda (main body)			535
Combined system (excluding East Bay and Colorado River)		1142	2380
	<i>TDWR (1980)</i>		
Lavaca	Lavaca+Navidad	847	1026
	Lavaca Bay peripheral	99	393
Lavaca Bay total*		946	1419
Tres Palacios		112	210
Matagorda (main body)			518
Combined system (excluding East Bay and Colorado River)			2147

* excluding Keller Bay, which is included in Matagorda main body

Table 2
 Monthly mean flows (cfs) at principal gauges
 from Ward and Armstrong (1980)

month	Lavaca at Edna	Navidad at Ganado	Colorado at Bay City
Jan	235	472	2067
Feb	310	550	2847
Mar	213	378	1972
Apr	406	670	2861
May	598	885	4187
Jun	476	951	3589
Jul	255	385	1478
Aug	104	213	884
Sep	295	761	1955
Oct	336	487	2481
Nov	281	521	2461
Dec	233	427	2099
Annual average	316	559	2424

the Navidad, and 68% of the total Lavaca-Navidad basin. The dam is, in fact, the head of tide. While it is unlikely that the lakes have had a major impact on the total annual flow to the estuary, it is probable that they have greatly influenced the time pattern of inflow, especially on the Colorado (Ward and Armstrong, 1980). It is also probable that the river loads of sediment and nutrients have been altered by the imposition of the reservoirs. The remaining principal inflows to Lavaca Bay, i.e. the Lavaca River and the minor streams listed in Table 1, are for practical purposes unregulated.

The last factor, the *density current*, is the circulation induced by the horizontal gradient in density established across the estuarine zone by the transition from a freshwater to a marine system, especially dictated by salinity, therefore also referred to as a "salinity current." Density currents in estuaries are exhibited in two different forms: vertical shear in the horizontal current,

and large-scale horizontal circulations. The first kind, the vertical shearing density current, is the classical estuarine tidal-average circulation, whose mechanics is that of denser water underflowing and displacing lighter water. The resultant circulation is a tidal-mean influx from the sea into the estuary in the lower layer, and a return flow from the estuary to the sea in the upper layer. Usually this kind of density current is exposed by averaging vertical profiles of current velocity over a tidal cycle.

The second kind of density current results from the absence of laterally confining boundaries, so that the return flow is completed in the horizontal plane, rather than in the vertical. This circulation is induced by the presence of a channel of deeper water, in which case the vertical-mean current is directed up (into) the estuary along the axis of the channel, and the return flow to sea takes place in the shallow open bay to either side.

This description of density currents did not refer to vertical stratification. Indeed, either kind of density current can take place even when the water-column salinity is homogeneous, because the driving force for density currents is the *horizontal* salinity gradient. The confined density current, especially, will tend to develop salinity stratification, but if the vertical mixing processes are sufficiently intense the salinity can still be maintained nearly homogeneous in the vertical. More information on the mechanics of estuary density currents is given in Ward and Montague (1996) and references cited therein.

The density current is one of the prime mechanisms for salinity intrusion into an estuary, and is especially prominent in regions of greater depth. A dredged ship channel, in particular, though a negligible fraction of the total volume of a bay, can have a disproportionate impact on salinity structure because of the greater density current in its deeper waters. With an idealized model, it can be shown that the density current increases roughly as the *cube* of depth. Creation of a 12-m ship channel, for example, where natural water depths are 4 m, represents a twenty-seven-fold increase in density current. For this reason, the density current is especially prominent in deepdraft ship channels dredged through shallow estuaries. Isohaline patterns frequently display a tongue of higher salinity water aligning with the ship channel.

The relative importance of these factors varies from estuary to estuary, and from place to place and from time to time within a specific estuary. Generally, these are the dominant sources of circulation and hydrodynamic variability in Matagorda Bay. Other factors, such as the Coriolis acceleration or turbidity gradients, can be locally or transiently important. Greater detail about the mechanics of these is given in Ward and Montague (1997), and specific to the physical system of Matagorda Bay in Ward and Armstrong (1980), and references cited therein.

2.2 Alterations of the Matagorda Bay system

Despite the relatively low level of peripheral development, Matagorda Bay has been subjected to several significant anthropogenic hydrographic modifications, which prove to have relevance to the proposed desalination plant. These alterations include diversion of the Colorado River to the sea, dredging of the deepdraft ship channel, creation of the entrance channel across Matagorda Peninsula, diversion of the Colorado back into Matagorda Bay and closure of Parkers Cut inlet.

An affliction of Texas rivers is their propensity to form log rafts, obstructions of brush, logs and sediments that—once formed—tend to become self-sustaining by the accumulation of additional debris until "blown out" by a severe storm or flanked by a new channel of the river. As the Colorado has one of the highest sediment loads of the Texas rivers, it could be expected to be prone to rafting, and, indeed, an extensive log raft has been a prominent feature of the lower river dating back to the early Spanish explorers (Clay, 1949). By the turn of the century, the raft impeded over twenty miles of the river, and its main section was 5 miles in length, about 300 ft wide and 25-50 ft thick, with trees with 2-ft-diameter boles growing on its surface (USCE, 1917, Wadsworth, 1966, Bouma and Bryant, 1969). This log raft hampered river traffic between Matagorda Bay and the inland communities, and increased the hazard of flooding in the upstream areas due to the backwater effects. (The early 20th century rice farming benefited from the dam created by the raft, however.)

Several abortive efforts had been mounted to remove the raft, but in 1925 a large-scale project was begun by the Wharton and Matagorda County Conservation and Reclamation Districts,

founded for this purpose. A 20 x 40 ft pilot channel was blasted from the raft head (by then at Bay City) and snagging operations were begun along this channel. In 1929, a flood breached the raft, freeing an enormous quantity of sediment and debris. The sedimentary load clogged the mouth of the river in Matagorda Bay and initiated progradation of the river delta across the eastern arm of the bay. The rate of delta growth was, by geological standards, breakneck, averaging 500 acres of new delta per year (Bouma and Bryant, 1969). Over the next decade, this rapidly growing delta expanded across the bay and isolated what is now East Matagorda Bay. The prograding delta created a backwater flood threat to communities on the lower river (as well as hampering navigation), so in the early 1930's, a channel was dredged through the delta across Matagorda Bay, through Matagorda Peninsula to the Gulf of Mexico.

One immediate consequence of this delta progradation and the associated dredging of a pilot channel is the diversion to the Gulf of Mexico of the greatest inflowing river to the bay system, the Colorado. Some Colorado River flow continued to find its way into Matagorda Bay, through the GIWW, which crosses the river below Matagorda, and at flood stage when overbank flows and minor distributaries divert some of the flood waters into the bay. Exchange between the Colorado and Matagorda Bay was further facilitated in the late 1950's when Parker Brothers dredged a cut from the Colorado channel, just inside its mouth, into Matagorda Bay next to Tiger Island, to provide access for its reefshell dredges to Dog Island Reef. This cut, Parkers Cut (a.k.a. Tiger Island Cut), quickly enlarged due to natural scour, developed its own washover delta inside the bay, and became a significant alternative inlet to the system. Not only did it provide direct access to the sea, but also passed significant volumes of Colorado River water into the bay.

Unlike Corpus Christi Bay, Galveston Bay, and Sabine Lake, in which deepdraft navigation channels were dredged incrementally over a period of many decades, Matagorda Bay had no deepdraft channel until 1963, when the 11-m project was created. This channel was a joint private-public project that served one function, to allow deepdraft access for Alcoa's bauxite facility at Point Comfort. The Corps of Engineers selected a route that transected the barrier island, Matagorda Peninsula, with an artificial landcut, rather than bringing the channel through the natural tidal inlet of Pass Cavallo. Intense tidal currents through this landcut rendered it

unstable when it was breached in 1963, and it continued to scour downward, finally stabilizing at depths ranging 15-20 m (25 m in a few scour holes). Its dimensions far exceed the original 12-m project dimensions, and it has never required maintenance dredging. The Matagorda Entrance channel also has become a classic example of tidal-prism capture, having captured fully half the original tidal prism of Pass Cavallo (Ward, 1982, van de Kreeke, 1985). Since 1963, Pass Cavallo has begun shoaling, and has lost over half of its original cross section.

Because of the close association of a deep ship channel with density-driven salinity intrusion, there has usually been gradual salination over time of an estuary with deepdraft channels. In the other Texas bays in which navigation channels have been implemented incrementally, increasing incrementally in project depth over perhaps a century, the gradual increase in channel depth renders it very difficult to quantify the effect of the channel on salinity from the other sources of variability. Matagorda Bay, however, presents the one case on the Texas coast in which a deepdraft channel was dredged rather suddenly across a bay in which there was previously no such channel. This provides a sort of real-world-scale controlled experiment. Using salinity data segregated into the period before and after creation of the ship channel (taken as the date of opening the landcut in 1963), Ward (1983) determined the incremental change in salinity. For Lavaca Bay, the net increase in salinity was about 5 ppt.

Though some proportion of the Colorado flow still entered the bay (proportion unknown, range of estimates 20-80%, see Ward and Armstrong, 1980), the opinion was held among fish and wildlife interests that the productivity of the bay would be improved if the river could be re-diverted into Matagorda Bay. As a result of a protracted political negotiation, the proposed USCE jetty project for the lower Colorado was augmented to include diversion of the river. Specifically, the project included the following additional elements (USCE, 1977):

- 12 x 100 ft flood diversion channel from the GIWW intersection with the Colorado, into the eastern arm of Matagorda Bay;
- Diversion dam in the present Colorado Channel below the point of diversion (the "plug" dam);
- Weir dam across Parkers Cut, thereby closing this inlet to Matagorda Bay.

The diversion channel was completed in 1990, the Parkers Cut closure in 1991 and the plug dam in 1992. The project was controversial, because there is far from unanimity regarding its environmental benefits (or disbenefits), and remains so to this day. There are proposals extant to reverse some or all of the project's elements.

In magnitude, the mean annual flow of the Colorado is about the same as the total other inflows to Matagorda Bay. Since about 1940 until around 1990, only a portion of the Colorado flow entered Matagorda Bay. If this proportion is estimated to be about 50%, the Colorado would then represent a third of the inflow to the bay under its pre-1990 configuration. With the diversion canal operational, the entirety of this flow will enter the bay. Considering that the Colorado debouches into the eastern arm of Matagorda Bay, at the most distant section of the bay from Lavaca Bay, it is unlikely that it would exert any direct effect on salinities in Lavaca Bay. However, if this inflow results in a net reduction of salinities in the open waters of Matagorda Bay (which has not been established from measurements), this could create an indirect effect by reducing the effective salinity boundary condition at the entrance to Lavaca Bay.

3. Project features

The proposed desalination plant operation will employ cooling water from the J
its operation is intimately coordinated with the power plant.

3.1 Power plant operation

The steam-generation cycle employs cooling water to re-condense high-pressure steam that spins the turbines. While the majority of steam-electric plants in Texas utilize freshwater as the source, there are a few sited on saltwater bodies. The Joslin S.E.S. is one such plant. Situated on the northwest shore of Cox Bay, it takes its cooling water from the turning basin at Point Comfort, and returns it to Cox Bay with a nominal temperature elevation of 8°C. The outfall area is separated from the ship channel and turning basin by an elongate "dogleg" spoil island extending west from the shore then south. These features are shown in the location map of Figure 2. Joslin is a 240 MW steam electric plant with circulating flow pump capacity of 226

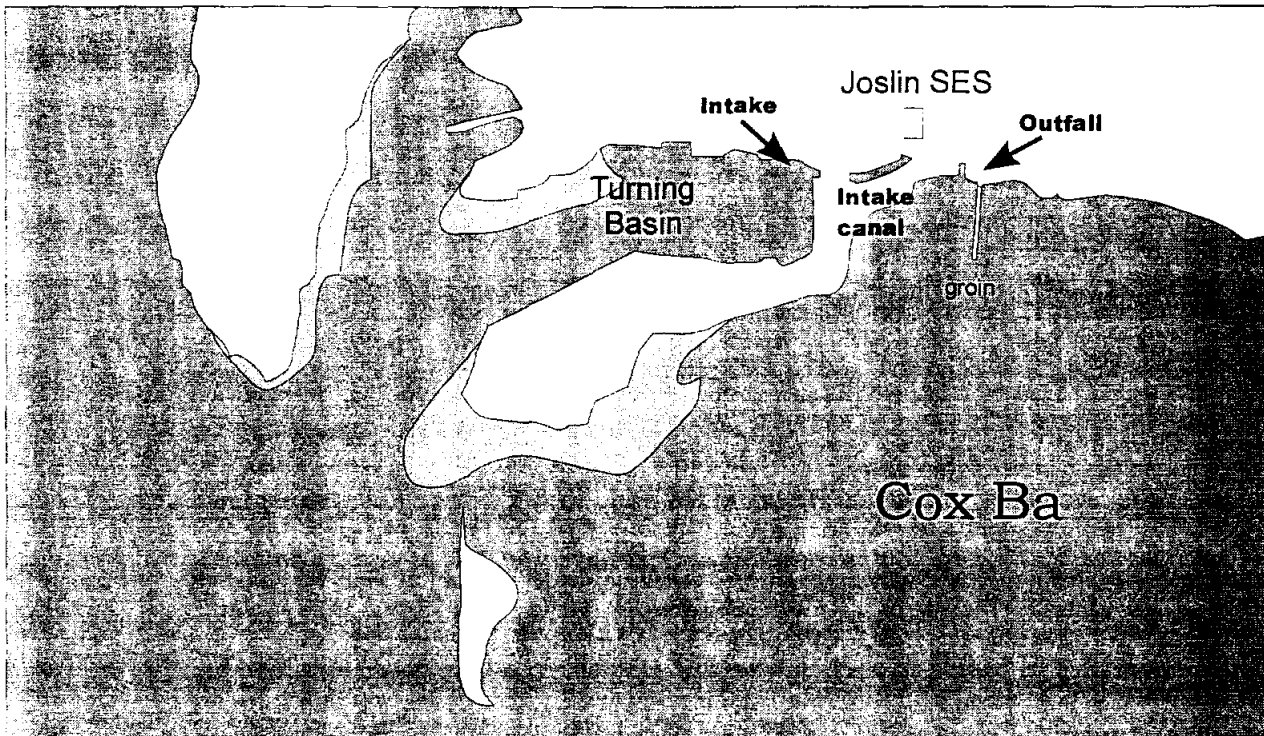

Figure 2 - Location map of Joslin station area

Table 3
Permit parameters for Joslin SES discharge permit
and related standards

Permitted circulating flow	357 cfs (231 MGD)
Permitted temperature rise of circulating flow at edge of mixing zone in Cox Bay:	1.5°F (JJA) 4.0°F (other times)
Permitted maximum temperature of circulating flow	106°F (daily mean) 112°F (daily maximum)
Temperature standard outside of mixing zone (Lavaca/Matagorda Bay)	95°F

MGD (350 cfs). Recent self-reporting data supplied by CP&L to this project indicate a circulating flow of about 340 cfs with a temperature rise of 14°F. Permit parameters for the Joslin discharge permit and related surface-water standards are summarized in Table 3. The power plant does induce a circulation from Cox Bay back to the turning basin, though the circuit forced around the dogleg peninsula is sufficient for dissipation of excess heat. Comprehensive and detailed evaluations of the plant discharge and its impacts were carried out in the 1970's when the plant came on line. Ward et al. (1975) performed detailed hydrodynamic measurements in the vicinity of the cooling water return, including tracking the discharge plume using fluorescent dye, to delineate the cooling water trajectory and time of travel. Extensive numerical modeling was carried out of the thermal plume distribution to establish the mixing zone for this discharge. Biological impacts were determined from field studies, as reported by Moseley and Copeland (1973, 1974).

3.2 Desalination plant and alternatives

While the proposed desalination plant has some complex aspects associated with process design, economics, and distribution, from the standpoint of its interaction with the environment, there are

Table 4
Design parameters for proposed desalination plant

Flow diversion into desalination plant	200,000 ac-ft/yr (276 cfs)
Flow output from plant (i.e., full operation delivery, mean and max)	100,000 ac-ft/yr (138 cfs)
Flow rejection	100,000 ac-ft/yr (138 cfs)
Salinity concentration factor	1.98
Nominal design influent salinity	25 ppt
Nominal effluent salinity for design influent	50 ppt

relatively few factors to be considered. The plant will intercept and divert a portion of the cooling water return from the Joslin plant, filter this water to reduce suspended solids, then pass the filtered water through the multistage desalination process. Water will be produced with total dissolved solids within drinking water limits, while the balance of the diverted water will carry the removed solids, thereby increased in salinity. Design parameters for the de-sal plant are summarized in Table 4, and a schematic of the Joslin SES cooling water circuit and the proposed de-sal water handling is sketched in Figure 3.

Three alternatives are under consideration for discharge of the increased-salinity (hypersaline) reject water:

- (1) remixing with the balance of the cooling water and discharge to Cox Bay through the present Joslin outfall structure
- (2) transport through pipeline and discharge to Matagorda Bay along the north shore
- (3) transport through pipeline to the Gulf of Mexico and discharge into waters of the coastal zone

Three alternatives are under consideration for the disposal of the solids filtered from the influent water: (1) offsite disposal, probably trucking and landfilling as solid waste, (2) remixing with the cooling water and discharge to Cox Bay through the present Joslin outfall structure, (3) remixing and discharging with the desalination plant reject water. It should be noted that handling of the hypersaline reject water from the desalination plant and handling of the solids

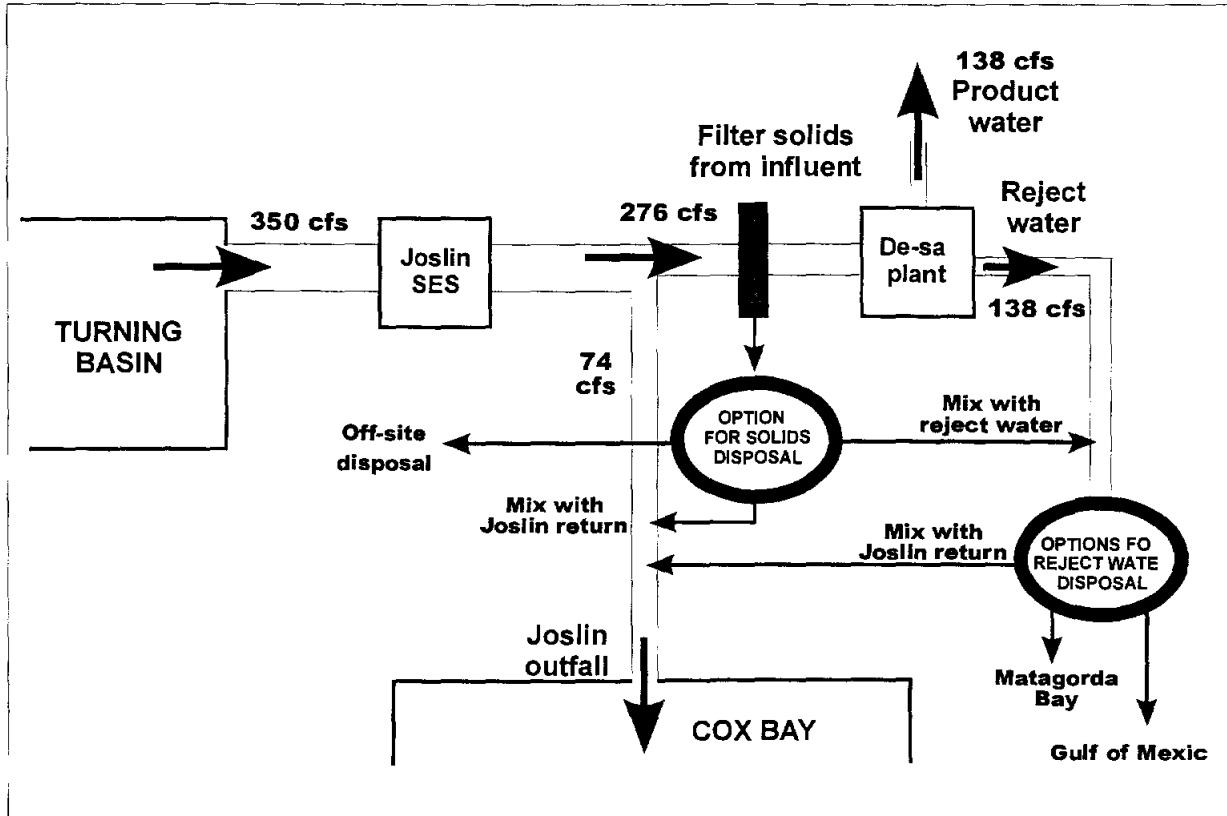

Figure 3 - Schematic of water flow through Joslin SES and proposed de-sal plant

filtered from the influent to the desalination plant are separate actions. Only if the reject water is remixed with the Joslin cooling water return, do the options for handling the filtered solids reduce to two, off-site disposal or discharging into Cox Bay through the existing outfall.

In order to quantify the plant operation, we assume permit conditions for the Joslin discharge (Table 3) with circulating flow at capacity of 350 cfs, and assume that the desalination plant will produce an annual flow of 100,000 ac-ft, equivalent to a constant production of 138 cfs, with a 2:1 concentration of salts in the reject water. This implies that the influent flow will be double the production flow, *viz.* 276 cfs. These flows are shown on Figure 3.

4. Interactions with the hydrographic environment

4.1 Salinity

Salinity in the project area is determined by the interplay of freshwater inflow and the dispersion of salt water into the estuary by tides, meteorological flushing and density currents. Salinity of Lavaca Bay will both affect and be affected by the desalination plant operation. The former arises from the salts in the influent water, which originate in the Joslin intake at the turning basin (see Fig. 3).

4.1.1 Ambient salinity and design conditions

The salinity in this vicinity is best addressed by inspecting the historical fluctuation of salinity based upon measurements. Ward and Armstrong (1980) compiled all available salinity and temperature data for the Matagorda Bay system, as a part of a comprehensive study of that estuary under the sponsorship of the U.S. Fish & Wildlife Service. The bay system was subdivided into hydrographic areas, and the salinity and temperature measurements were sorted into these areas, then statistics were computed for each hydrographic area.

Unfortunately, the raw digital data base was eliminated by changes in computer hardware in the late 1980's. But the statistics remain, reported in Appendix D of Ward and Armstrong (1980). For the hydrographic area encompassing the Joslin intake area (L-3), the mean salinity for the post-ship-channel period (i.e., after September 1963) was determined to be 14.3 ppt, with a standard deviation of 7.6 ppt, based upon a set of 974 independent measurements, see Table 5. Figure 4 displays the normal cumulative distribution (ogive) with these parameters. Assuming these data are in fact normally distributed, this would imply a 5% exceedance value of 26.9 ppt, and a 1% exceedance value of 32.1 ppt.

Texas Parks and Wildlife Department (TPWD) provided to this study a copy of its hydrography measurements obtained as part of the TPWD Coastal Fisheries data collection, for the period 1992 - 1998. These measurements encompass the entire Lavaca Bay system, and include the

Table 5
 Statistics of salinity (ppt) in Lavaca Bay from several data sources

<i>data source</i>	<i>region of bay</i>	<i>period of record</i>	<i>number of measurements</i>	<i>average</i>	<i>standard deviation</i>
USFWS*	mid-bay	1963-79	974	14.3	7.6
TPWD	entire bay	1992-98	1111	13.9	9.3
TPWD	mid-bay	1992-98	450	14.3	8.8

* Ward and Armstrong (1980) Area L-3

parameters salinity, temperature and turbidity. Statistics of salinity from these, as well as the Ward and Armstrong (1980) data are summarized in Table 5. Salinity statistics for both the entire data set, and for the mid-bay area extending from below Cox Bay to the causeway

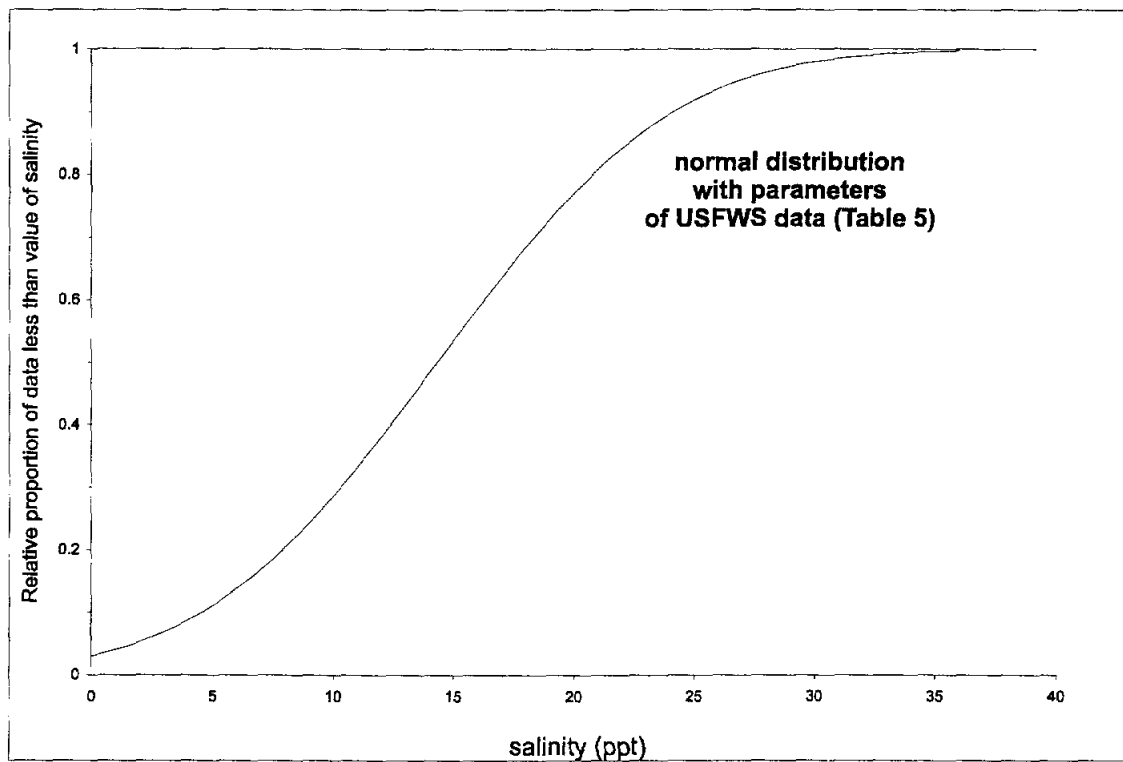

Figure 4 - Ogive of normal distribution with statistical parameters of salinity from Ward and Armstrong (1980), Hydrographic Area L-3 (Mid-Lavaca Bay), see Table 5

(corresponding approximately to Area L-3 in Ward and Armstrong, 1980) are given in this table. Despite the differing period of record, these gross statistics, for a highly variable hydrographic parameter, are surprisingly consistent.

Figure 5 displays the ogives for the TPWD data set, both the entirety of Lavaca Bay, and the mid-bay region alone. These are not fitted distributions, but empirical ogives determined from the rank-ordered arrays of data. The normal cumulative distribution with the same mean and standard deviation as the Ward and Armstrong (1980) data shown in Fig. 4 is superposed on Fig. 5, for comparison. Again, despite the fact that the TPWD data represent a different period of record, the two distributions are surprisingly consistent.

These statistics indicate the general behavior of the parameter. The extremes of salinity are also of interest. The lower limit on the salinity range is zero, since Lavaca Bay is driven to fresh

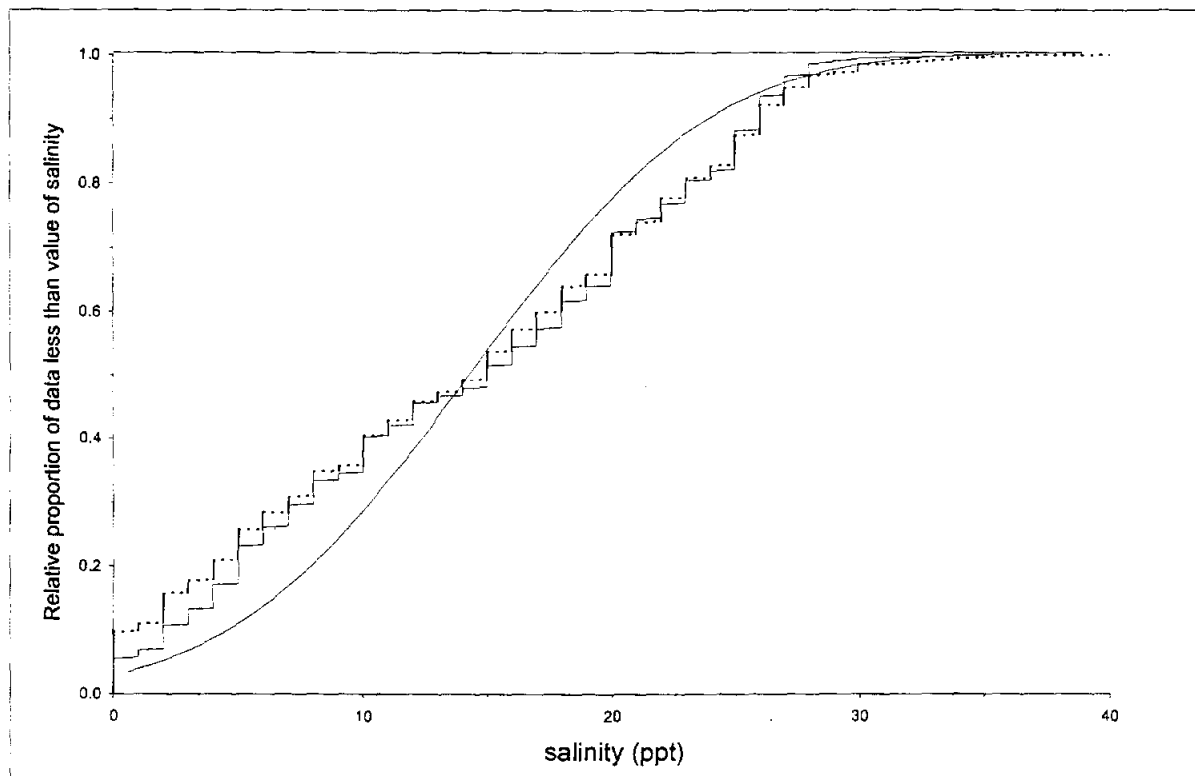

Figure 5 - Empirical ogives for Lavaca Bay (broken) and Mid-Lavaca Bay (solid) for salinity, from hydrographic data of Texas Parks and Wildlife, see Table 5

salinities under flooding conditions on the Lavaca and Navidad rivers. Because the raw data have not survived from the Ward and Armstrong (1980) compilation, it is impossible to determine the upper range of salinity for this data set. For the TPWD data set, the highest measured salinity from the entire Lavaca Bay system is 40 ppt, and the maximum value observed in the mid-bay region is 35 ppt. These data illustrate the potential for salinities at the intake site—south of the causeway and in the dredged ship channel—to equal (and perhaps exceed) that of seawater.

Because salinity is strongly influenced by river inflow to the estuary, it exhibits long cycles of high and low values corresponding to droughts and freshets. While 5% (say) of the measurements may exceed 26.9 ppt, these 5% will occur in a prolonged series (i.e., the parameter is highly autocorrelated in time). From a water-supply point of view, the occurrence of such high-salinity periods will be correlated with stressed water supply requirements.

An example of this occurred in summer 1984, when extremely dry conditions led to increased salinities throughout Lavaca Bay, to the point that an emergency release of 10,000 ac-ft of water from Lake Texana was ordered by the state, commencing on 29 August. Several state agencies monitored salinities during this episode. The measurements were generally restricted to the Lavaca and Navidad rivers, the marsh system, and Lavaca Bay out from the river mouths. During this period, and in this region north of the causeway, high salinities exceeded 30 ppt (TDWR, 1985).

In view of the fact that the most important operations of the proposed desalination plant will be under drought conditions, a salinity considerably higher than the average value of around 15 ppt was selected as the design conditions, *viz.* an influent salinity of 25 ppt. This corresponds to an exceedance of about 90%. For estimation of environmental impacts, both the average salinity conditions and the low-flow design conditions are considered.

4.1.2 Discharge impacts on salinity

The potential impact of the desalination plant on the salinity of the receiving water is due to the discharge of effluent with salinity increased by removal of the water-supply component, see Fig.

3. If a flow Q with salinity S_o is subjected to an extraction of freshwater at flow Q_d , then the salinity of the remaining flow $Q - Q_d$ is:

$$S_o / (1 - Q_d/Q) \quad (1)$$

Applied to the de-sal plant alone, Q is the total flow diverted through the de-sal plant, and the reject flow is $Q - Q_d$. If $Q_d = 0.5 Q$ as specified in Table 4, then the effluent salinity is approximately $2S_o$. ("Approximately" is stated because this equation assumes that the salinity of the product water is zero, while in fact it will be at or below the TDS for drinking water.)

Discharge Option 1: Cox Bay return

Equation (1) also applies to the series of the Joslin and de-sal plant, operating together, when the de-sal reject water is re-mixed with the Joslin cooling water return, in which case Q is the total intake flow of the Joslin plant, and equation (1) gives the salinity of the return flow to the bay after the de-sal effluent is mixed into the power plant return. If we assume full-capacity circulation of 350 cfs, and production of 138 cfs from the de-sal plant, then the salinity of the combined return (Joslin Outfall 001) will be increased by a factor of 1.65. For example, with the average intake salinity of 15 ppt, the Joslin outfall will return 212 cfs at 25 ppt.

This scenario can be viewed either of three ways: as a removal of 138 cfs of freshwater from Lavaca Bay, as a mass load of salt, or as an *incremental* salt load given by a flow of $Q - Q_d = 212$ cfs and salinity increment above ambient of 0.65 times the intake salinity. We choose the last, because this viewpoint will facilitate consideration of the Matagorda Bay discharge alternative, as well, though the others yield equivalent results.

The volume of Lavaca Bay is 285 Mm³. A flow of 212 cfs = 6.00 m³/s translates to 16 Mm³/mo. Thus, if no exchange of Lavaca Bay water is assumed to occur for an entire month, that is, if we adopt the worst-case assumption that Lavaca Bay is an isolated waterbody for this time period, the resulting impact will be to raise the average salinity by an increment $0.65 \times 16/285 = 0.036$ times the average salinity. For the average salinity of 15 ppt, the increment due to the de-sal rejection discharge would be about half a ppt.

In order to evaluate exactly how consequential this level of impact is, two additional pieces of information are needed. First, the impact on salinity is cumulative in time. The longer Lavaca Bay remains subject to the discharge of higher salinity water without any source of dilution water, the greater the net increment in salinity, by a monthly rate of a factor 1.036. Second, this worst-case calculation needs to be refined by considering the actual sources of dilution water. With respect to the first, the scenario of greatest concern would be a period of high salinity sustained for several months. Such a scenario is represented by the seasonal summer low-flow regime.

With respect to the second, the hydrographic controls discussed in Section 2.1 above are the mechanisms that routinely exchange water between Lavaca Bay and Matagorda Bay (and, ultimately, the Gulf of Mexico), thereby providing additional dilution for the discharge from the de-sal plant. We consider the summer low-flow scenario. Under these conditions, freshwater throughflow would not be a major source of dilution. The estuarine density current would also be reduced in its circulation, because the horizontal gradient in salinity (which drives the density current) is practically flat under low-flow conditions. But the longer period components of the tide, especially the fortnightly and biennial secular variations, and the flushing effects of wind systems, could still be expected to operate. Computation of the water exchange effected by these processes can be quantified by analysis of water-level records, but such an undertaking could not be performed within the scope and resources of this planning study. (An example of such an analysis for Corpus Christi Bay is the report by Ward, 1997.)

As an order of magnitude estimate, the summer low-flow could be expected to be sustained for, say, 3 months, during which the secular variation would increase water levels in Lavaca Bay

(from the typical seasonal low stage in early summer), and the bay would be subject in addition to 6 complete cycles of the fortnightly astronomical tide. If we judge about a 1/3 volume replacement resulting cumulatively from the combination of these processes, and we further assume a 25 ppt average salinity in the bay, the net *increment* in salinity after 3 months would be $25 \times [(1.036)^3 - 1] \times 0.67 = 1.9$ ppt.

Discharge Option 2: Matagorda Bay return

The second discharge option is to pipe the de-sal rejection water to a point of discharge on the north shore of Matagorda Bay between Keller and Karankaway Bays. This will represent a flow of 138 cfs with a salinity twice that of the influent, see equation (1).

Referring again to the data compilation of Ward and Armstrong (1980), the discharge area corresponds to their area M-5, which extends from Sand Point to the mouth of Tres Palacios Bay, and out into Matagorda Bay about 6 km. This is a more saline environment than Lavaca Bay, with average salinity 21.1 and standard deviation 5.9, based upon 684 measurements (Ward and Armstrong, 1980, Appendix D).

Under the same average conditions, the influent would have salinity about 15 ppt (cf. Table 5), so this option would entail discharge of 138 cfs of 30 ppt salinity water into upper Matagorda Bay, i.e. 9 ppt above the salinity of the receiving water. Under design conditions, for Lavaca Bay the influent 25 ppt corresponds to an exceedance frequency of 0.92, and the salinity in Matagorda Bay at the same exceedance is 29.5, so that the de-sal would entail a discharge of 138 cfs of 50 ppt water, or salinity 20.5 ppt above that of the receiving water.

Matagorda Bay is deeper than Lavaca Bay and intensively mixed. The vertical profiles of water quality compiled by Ward and Armstrong (1980) indicate little stratification, which is evidence of the intense mixing. For estimation purposes, we assume that the de-sal discharge is well mixed over the open waters of Matagorda Bay, an area we take to be about 450 km², and volume 900 Mm³. The discharge flow of 138 cfs translates to 10 Mm³/mo. Under average conditions, the salt load of 9 ppt at 10 Mm³/mo would result in an increment averaged over the receiving

water of 0.10 ppt after each month. Under design conditions, the incremental salt load 20.5 above ambient would result in an average increment over the receiving water of 0.22 ppt.

Under the same conditions as evaluated in Option 1, in which a 3-month low-flow period is assumed with a nominal estimate for exchange, the net salinity increment is clearly only a fraction of a part per thousand.

Discharge Option 3: Gulf of Mexico

The effective volume of the receiving water and the intensity of mixing for this case accomplish practically infinite dilution, so the impact on large-scale salinities in the Gulf is considered negligible. This option is essentially a no-impact case (with respect to Matagorda Bay), because it has the effect of removing an impact on salinity in the estuary.

4.2 Temperature

Salinity exhibits large-scale horizontal gradients in Lavaca and Matagorda Bay, because the salinity patterns are governed fundamentally by the lateral influx of freshwater from the head of the estuary and the lateral influx of salt water from the mouth. Water temperature, on the other hand, is more uniform in the horizontal, and varies primarily in response to climatological factors. The same data sources as discussed in the previous section were exploited to characterize the statistics of ambient temperature in Lavaca Bay. These data are summarized in Table 6. As was found in the case of salinity, there is remarkable consistency between the older Ward and Armstrong (1980) statistics, and those from the more recent TPWD data. Figure 6 displays the ogives for winter and summer temperatures, assuming a normal fit with the Ward and Armstrong (1980) parameters given in Table 6.

The most important temperature-related aspect of the impact of the proposed de-sal operation on Lavaca Bay is that the present heat load imposed on Cox Bay by the return of the Joslin cooling water will be reduced. For discharge Option 1, in which the de-sal rejection water is re-mixed in

Table 6
 Statistics of temperature (°C) in Lavaca Bay from several data sources

<i>data source</i>	<i>region of bay</i>	<i>period of record</i>	<i>number of measurements</i>	<i>average</i>	<i>standard deviation</i>	
USFWS*	mid-bay	1963-79	annual	1026	22.5	3.2
			Jan-Feb	208	14.3	4.4
			Jul-Aug	164	29.8	2.3
TPWD	entire bay	1992-98	annual	1111	22.4	6.1
TPWD	mid-bay	1992-98	annual	450	22.0	6.8

* Ward and Armstrong (1980) Area L-3

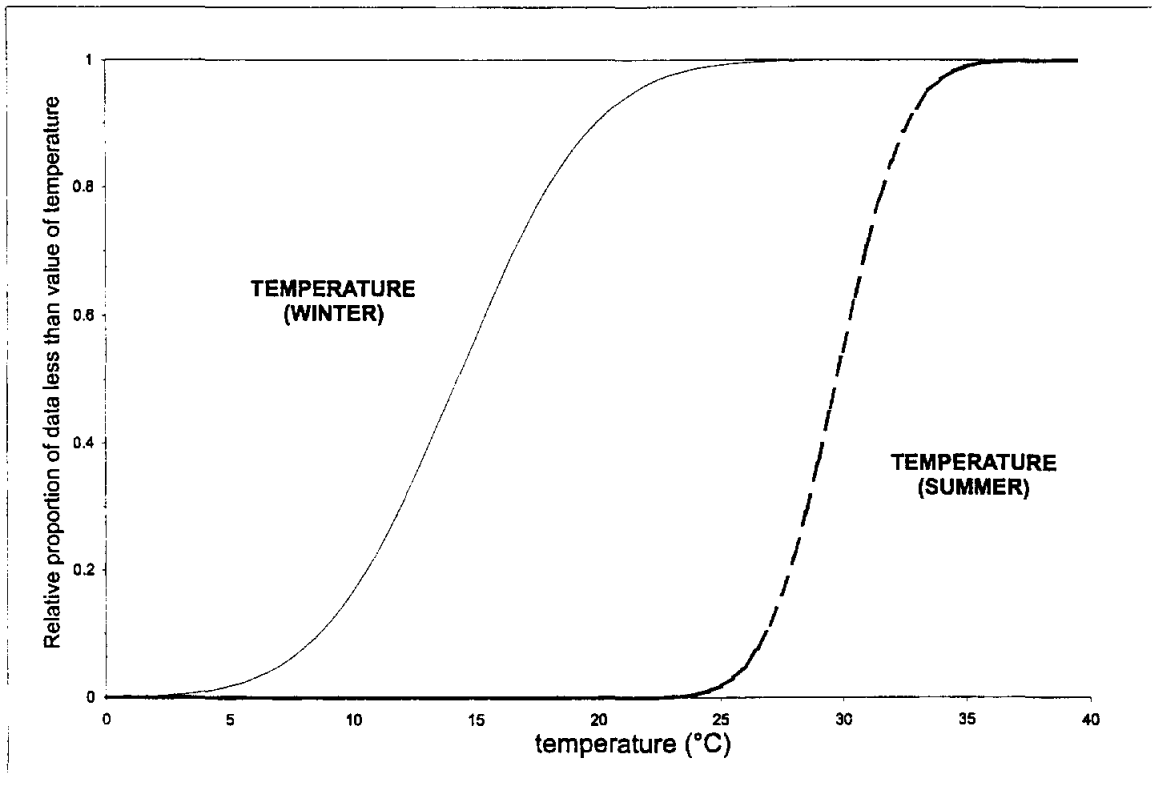

Figure 6 - Normal distribution ogives for temperature in Lavaca Bay

the Joslin return flow, the net volume discharged to Cox Bay will be reduced from 350 cfs to 212 cfs. USFilter staff indicates that a slight heating of the water will result from the diversion pump, but that this heat will be dissipated through the de-salination process, so the net additional heat load will be negligible. With no change in the temperature excess associated with the rejection water of the de-sal operation, this would amount to a net decrease in the heat load to Cox Bay of about 40%. For discharge Option 2, in which the de-sal rejection water is pumped to Matagorda Bay, the discharge into Cox Bay would be reduced from 350 cfs to 74 cfs, a net reduction in heat load to Cox Bay of 80%, but in this case a part, about 40%, of the Joslin heat load would be transferred to Matagorda Bay, where the more intense mixing should decrease the thermal plume area.

4.3 Suspended solids and turbidity

The historical data base of Ward and Armstrong (1980) did not include total suspended solids, since relatively few measurements of this parameter were extant in the older data. To characterize the suspended solids content of the influent water, other data sources were sought. These and the statistics of the data sets are summarized in Table 7.

The Conrad Blucher Institute (CBI) of Texas A&M University—Corpus Christi collected water samples for TSS determinations during the hydrographic studies of ALCOA as part of the mercury-remediation Superfund program. These data were taken at the CBI platform in Lavaca Bay, located west from the Joslin site and south of the causeway, more or less central in Lavaca Bay. Sampling interval varied from twice daily to four times daily, therefore these data are intensive in time. Data were collected from 4 July 1996 through 1 April 1998. Of a total of 1592 samples, TSS averaged 50.5 ppm with a standard deviation of 64.2 ppm, and ranged from 5.7 to 1294 ppm. Exceedance values are given in Table 7.

The Joslin intake is situated in a relatively sheltered area behind a spoil island. It is also in a deepdraft channel, where fine silts are subject to resuspension by ship traffic. It is not clear, therefore, whether the CBI platform located in the open waters will adequately characterize the

Table 7
Statistics of TSS (mg/L) data from Lavaca Bay

<i>Statistics</i>	<i>Data set by source</i>			
	<i>CBI Lavaca Bay platform</i>	<i>Alcoa recon ship channel tidal flat</i>		<i>TPWD Lavaca Bay stations</i>
period of record	Jul 96 - Apr 98	Apr 96	Apr 96	1992-98
number	1592	9	4	1110
mean	50.5	67.7	46.4	61.4
st dev	64.2	60.4	25.7	62.4
max	1294	220.2	75.7	540
min	5.7	20.8	21.7	6.0
exceedance (%):				
99	10			8
95	14.1			12
90	16.7			14
50	32.7			36
10	96.3			144
5	136			200
1	292			260

influent TSS, nor whether the TSS in the intake area could be expected to be higher or lower than that in the open bay. Unfortunately, very few measurements exist for the immediate vicinity of the intake. The only such data located thus far are those collected by ALCOA in April 1996. ALCOA conducted a "mercury reconnaissance" study in the vicinity of its facility, mainly focusing on sediment data, but in the process obtaining a few measurements of TSS. Two of these stations were located in the ship channel behind dredge island, one (SC-1) in the ship channel spur leading to the ALCOA dock (and northwest of the turning basin), and the other (SC-2) in the entrance to the turning basin (and the Joslin intake bay). Statistics of the TSS measured are given in Table 7: these 9 measurements averaged 67.7 mg/L. In the same sampling exercise, water samples were collected in water less than a foot deep over intertidal mudflats adjacent to the ship channel at ALCOA's facility, also give in Table 7. The number of such measurements is so few that it would be aleatory to infer anything about the relative TSS of the intake area.

One additional source of data is the routine measurement of turbidity carried out by TPWD, and included in the data set provided to this project. These are measured in nephelometric turbidity units (NTU), approximately half the value of the corresponding TSS, see Appendix. With this conversion, the 1110 TPWD measurements from Lavaca Bay prove to average 61 mg/L TSS with a standard deviation of 62 mg/L, Table 7. This is in (perhaps surprising) agreement with the statistics derived from the intensive measurements, but shorter period of record, from the CBI Lavaca Bay platform.

A reasonable estimate of the average TSS in the intake area is 50 mg/L. The importance of these TSS statistics is that they imply a substantial volume of solids to be filtered from the influent water to the de-sal plant, see Fig. 3. The project design specifies no addition of chemical coagulants to facilitate the filtration, so the present focus is on the removal of solids already present in the influent. There are three options for disposing of these filtered solids, as noted in Section 3.2 and Fig. 3, offsite disposal, re-mixing in the Joslin return flow, or re-mixing with the de-sal reject water. (Of course, for the option in which the de-sal reject water is re-mixed with the Joslin return flow, the last two options become equivalent.) The principal impacts of the offsite disposal option are economic. For planning purposes, this option is considered to be trucking the solids to a landfill site. The impacts are the economic investment in the trucking process itself and the commitment of landfill volume to accommodate the solids. Re-mixing the solids in the de-sal reject water and piping the effluent to either Matagorda Bay or the Gulf of Mexico results in a net removal of these solids from the Lavaca Bay system.

Re-mixing the solids in the Joslin return flow and discharging these to Cox Bay in effect accomplishes exactly what is being done with these solids now. However, consistent with the viewpoint taken in Section 4.1, we can regard this as an effective increase in concentration of TSS in the Joslin outfall. If the reject water from the de-sal plant is also re-mixed in the Joslin return flow, then the net increase in concentration of the return water is 0.65 times the influent TSS, or an increase of 33 mg/L. Using the same calculation as in Section 4.1.2, Option 1, the increase in average TSS in Lavaca Bay resulting from return of the filtrate will be 0.036 times

the ambient average TSS, per month, or 1.8 mg/L in one month. Considering the normal turbid conditions of the bay, and the high natural variability in TSS, this is considered negligible.

If the reject water is piped elsewhere for discharge, but the TSS is remixed in the (remaining) Joslin return flow, this is equivalent to a mass load of 1 M kg solids per month into the volume of Lavaca Bay (285 Mm³), or an increment of 3.5 mg/L concentration per month. Again, compared to the high ambient turbidity and its natural variability, this is small.

We note that because the solids are filtered from the water medium, we have an intermediate option for their disposal. If half of the solids are remixed with the reject water, the resulting TSS will equal that of the influent. If this reject water is then remixed with the Joslin return, the combined discharge will be exactly at influent TSS and will therefore represent a zero load of TSS to Lavaca Bay. The remaining half of the solids filtered from the influent would then be disposed offsite, halving thereby the cost for their disposal.

5. Conclusions

5.1 Summary of anticipated environmental impacts

The proposed desalination plant will entail a mechanical diversion of a portion of the cooling water of the Joslin S.E.S. from the discharge stream after the water has been heated by passage over the condensers. Environmental impacts that may result from the desalination plant are considered according to whether their effect on estuarine organisms is direct, i.e., the consequence of properties or operation of the plant, or indirect, i.e., a modification of the aquatic environment which may in turn affect estuarine organisms.

5.1.1 Direct biological impacts

Two potential sources of direct biological impacts were considered, the results of constituents carried in the effluent, and the results of the physical action of pumping and plant circulation, i.e. entrainment and impingement. Either of these categories of impacts is intimately related to the Joslin cooling-water circulation.

The Joslin S.E.S. presented the first opportunity on the Texas coast to perform rigorous before-and-after studies of the impacts of a recirculating power plant on a coastal bay (the second being the Cedar Bayou Station of Houston Lighting and Power on Trinity Bay in the Galveston system). In accordance with permitting requirements of the Texas Water Quality Board, a program of hydrographic and biological sampling was implemented in August 1969, prior to the operation of the power plant (Moseley and Copeland, 1971), and continued through June 1973 (Moseley and Copeland, 1973, 1974). A network of sampling stations was established in Cox Bay, as well as in Keller Bay, which served as a reference site. The data included sampling of benthos, nekton, phytoplankton and zooplankton. Power-plant operation commenced in June 1971. This project therefore acquired nearly two years of data prior to the plant operation, and two years of data with the plant in operation.

Two constituents are of concern with respect to direct effects of the Joslin effluent: its temperature elevation, which could result in thermal shock to exposed organisms, and toxic chemicals entrained from the turning basin area and transported into the shallow waters of Cox Bay. Any such adverse effects of the discharge plume could be expected to be manifested in the data of the Moseley and Copeland ecological studies. The fundamental conclusion of these studies is that no substantial effect on Cox Bay ecology could be discerned in the data.

This conclusion supports the judgment that the power-plant return contains no constituents resulting in species shifts in the bay, whether due to adverse physiological responses, including acute toxicity, or avoidance of the plume area (an indirect effect, to be considered in the next section). This basic judgment is confirmed by more specific monitoring carried out routinely by CP&L in accordance with its discharge permit. According to CP&L staff, since about 1990 CP&L has been required to conduct biomonitoring tests annually on Outfall 001 (the once-through cooling return). No failures of the tests have occurred, and as a result CP&L has never had to perform any toxicity reduction evaluations (TRE's).

With the addition of the de-salination plant, no additional constituents will be added to the reject water, and in particular the use of coagulants is eschewed. The sole effect of the de-salination process will be to concentrate in the reject water any dissolved constituents present in the influent, at worst case by a factor of 2, see Table 4 (that is, assuming all such dissolved matter is removed from the product water). This concentrated flow will then be diluted by the extent to which it is re-mixed with the Joslin cooling water return, and by the natural mixing processes in the receiving water body. Apart from the hydrographic variable salinity, which may have an indirect effect, there is no evidence at present of any constituent in the Joslin return whose doubled concentration would result in biological impacts. Priority pollutant analyses performed by CP&L on water samples collected in March 1998 were provided to this study. Slightly elevated concentrations of barium, cadmium and zinc are reported, the remainder of the metals being below detection limits (except for aluminum and magnesium, for which there are natural terrestrial sources), and all organics that were analyzed (primarily volatiles) are below detection limits. While additional water quality analyses will probably be necessary to establish this incontrovertibly, at this point a direct biological impact is unlikely.

In the ecological evidence from the Moseley and Copeland study, thermal shock does not appear to result in a discernible impact on Cox Bay ecology. With the de-sal operation, the reject water will be unchanged in temperature. Whether this water is re-mixed with the Joslin return flow, or piped to a remote location for discharge, the effect is a reduction in heat load to Cox Bay. Therefore, the proposed de-sal plant will not increase the threat of thermal shock, but, instead, will reduce it.

Adverse physical injuries of organisms that arise from impact with elements of the intake structure or from transport through the cooling system of the power plant are referred to, respectively, as impingement and entrainment. The power-plant cooling water is subjected to extensive screening and filtering to prevent the entrainment of larger organisms (as well as debris). According to CP&L staff (G. Carter, pers. comm.), water is drawn from the Point Comfort turning basin (bottom elevation -39 ft NGVD) into the plant's intake canal (bottom elevation -10 ft NGVD), then travels to the pump intake cribhouse (vertical extent -17 ft to +18 ft NGVD). A set of bar grills with a travelling trash rake removes large debris, which is dropped into a hopper and flows to a wash trough. The influent water passes through a travelling screen, with a design mesh of 3/8 in (1-cm) square openings. Design clean-screen water velocities are 2.44 fps (one circulating pump) and 3.07 fps (one circulating pump and one salt water pump). The screens are cleaned by a 500 GPM screen wash pump, which flushes the larger organisms and screen debris into the wash trough. Until 1997, the wash trough discharged into the plant storm drain system. In 1997, this was changed so that the wash trough effluent discharges directly to the west side of the outfall structure, through a 16-in pipeline. All organisms larger than about 1 cm are intercepted by the travelling screen system and diverted to the outfall area.

For one year, November 1973 - November 1974, intensive biological sampling was carried out by Moseley et al. (1975) to determine exactly the number of organisms impinged at Joslin and their mortality after handling by the traveling screens and backwash system. These were found to be almost entirely nekton, and relatively small-sized (on the order of 10 g each), hence possessing limited swimming capabilities. About eighty percent of the impinged organisms were blue crabs and penaeid shrimp. By scaling the rate of impingement, Moseley et al. (1975)

estimate about 1.5 M organisms per year for a biomass of 17,000 kg per year, or about 18 organisms per M gal of circulating flow. From field catches in the Matagorda Ship Channel near the turning basin, this was determined to be about 1.3% of the organism density per gallon, an impact on the total population equivalent to that of one shrimp trawler. Of these about 4% met their maker, indicating that mortality from impingement is on the order of 0.05% of the population in the vicinity of the turning basin.

The plant intake structure operates today as it did in the early 1970's when the plume impact studies were performed by Moseley and Copeland (1973, 1974). The only modification has been an extension of the intake structure of about 150 ft associated with port improvements to the turning basin (dredging and bulkheading) around 1990 (G. Carter, pers. comm.). As noted above, since the time that these studies were done, several modifications have been made to the screening and backwash structures that should reduce impingement mortality to an even smaller number. Because the diversion pumps for the proposed de-sal plant will be placed after the circulating water passes the condensers, and installation of the de-sal plant will require no modifications in the pumping velocities or intake structure of the Joslin station, no alteration in the present impingement rate will result from this plant.

Organisms smaller than about 1 cm pass through the intake screens. According to CP&L (G. Carter, pers. comm.), these are entrained by the salt water pumps, directed to the one-pass shell-and-tube heat exchangers, and then carried to the outlet side of the circulating water line. This flow next passes to the circulating water pumps that move the water into a 66-in line and then an 84 inch line to the condensers. Beginning in 1986, this flow is filtered once more before each condenser inlet water box by a four-chamber backwash debris filter with 1/4-in (6 mm) screens and automatic backwash, which diverts filtered macrobiological organisms back to the condenser outlet water box discharge line. The discharge from each outlet water box is carried by a 66-in line, thence to a 84-in discharge line to the outfall structure. Here the top of the discharge line is at elevation +7 ft NGVD and the water flows over the seal well set at +8 ft NGVD. On the downward slope of the seal well, several dragon teeth are present to provide momentum dissipation and aeration. Passage through the condenser structure requires about 5 minutes (Moseley et al., 1975).

Organisms entrained in the plant are largely planktonic, especially zooplankton. Moseley et al. (1975) conducted bimonthly sampling at Joslin from June 1974 to February 1975 to determine the volume of organisms entrained in the cooling water and their mortality upon passing through the plant. Damage to entrained phytoplankton was established by comparative metabolism measurements on samples from the intake and discharge. This demonstrated a depression in net photosynthesis with passage through the condensers, but no change in respiration. The data were noisy but indicated reductions in production of about 25%. Moseley et al. (1975) point out that turnover and growth rate of phytoplankton is very high, so such a reduction in production should be short-lived. They also note that this in no way impairs the use of this phytoplankton as food for herbivores.

Similar studies of zooplankton entrainment were carried out at the same time. Mortality of zooplankters was determined visually, by exhibition of motility and by physical damage to the organism. Zooplankton in Cox Bay form an abundant and diverse group of organisms. Although dominated numerically by copepods, notably the cyclopoid *Acartia tonsa*, larval mollusks, other invertebrates, and larval fish are abundant components (Moseley and Copeland, 1974). The ecological studies determined that zooplankton were numerous throughout the year, with little seasonality or spatial variation. (One exception was slightly lower numbers in the intake vicinity, which corresponded directly to low numbers in the outfall vicinity, see Moseley and Copeland, 1973). In the entrainment samples, very few larval fish or crustaceans were collected. The dominant species was *Acartia tonsa*. Overall mortality was found to be 32%, and for *A. tonsa*, 38%. The same qualifications about turnover and utilization apply to the zooplankton as well as the phytoplankton.

The above mortality estimates were based upon samples taken before and after passage through the condensers. The de-sal intake will be placed after this, so the condenser mortality will have already resulted before the organisms are diverted to the de-sal intake. Additional filtration will take place at this point. No information is available as to the possible mortality of this stage of the process, however the filtration process is being designed to minimize impacts on entrained organisms. As a worst case, for planning purposes we may assume total mortality of the

remaining 70% viable plankton. The study by Moseley et al. (1975) did not address the impact of entrainment on the total resource of plankton. If we assume that this is of the same proportion as that of nekton (which would be valid to the extent that both can be regarded as passively transported by the circulating water), then this would imply that a minute fraction of the organisms in the vicinity of the turning basin pass through the plant, just over 1%. Even if these are totally lost to the system, the ecological impact should be negligible. The qualifications of Moseley et al. (1975) about the retained value of dead plankton to the ecosystem also apply, provided the filtrate (i.e., filtered solids) is returned to the bay.

5.1.2 Indirect biological impacts

Indirect biological impacts are those that result in alterations to the estuarine ecosystem as a result of modified hydrography, notably temperature and salinity. The principal regions of modification would be in Cox Bay. The historical studies of before-and-after ecosystem functioning of Moseley and Copeland (1973, 1974) focused on Cox Bay. Their primary conclusion was that their data evidenced no discernible difference in ecosystem structure after the plant went on-line from the pre-plant conditions, except avoidance of the thermal plume mixing zone during high-temperature summer conditions (but this was compensated by an attraction to the thermal plume area during the other seasons).

The proposed de-sal plant will remove a portion of the pure water in the circulating flow, including its excess heat, but will filter out the suspended solids (entrained organisms included) and concentrate the dissolved solids in the process reject water. The effects on the Lavaca Bay hydrography based upon the no-exchange assumption (see Section 4.1 above) are summarized in Table 8. As a standard of comparison, recent concern was created by the proposal to enlarge the Houston Ship Channel in Galveston Bay, projected to increase the average salinity in the bay about 2 ppt. Table 8 indicates that the proposed de-sal plant will increase the average salinity about one-half ppt, and this is in only one segment of Matagorda Bay comprising 15% of the total bay system. This is clearly a much smaller salinity impact that was involved in the Galveston project. Moreover, this was based upon an assumption of no dilution water, so this is an upper bound on the effect of the de-sal plant on salinity.

The effect on temperature structure would be considered beneficial by most resource agency personnel, since the heat load to Cox Bay will be reduced substantially. The estimated increase in TSS of about 2 ppm/mo would imply increments after 3 months of 6 ppm, only 10% of the average TSS and well within the natural variability of this highly variable parameter.

The important conclusion from the rough estimates of Table 8 is that, while some of the incremental changes in hydrography are nonnegligible and may warrant more refined study, none of these is large enough to represent a fatal flaw in the project.

Table 8
Estimated effects of de-salination plant on Lavaca Bay hydrography

<i>plume property</i>	<i>reject water discharge options</i>		
	<i>Joslin outfall</i>	<i>Matagorda Bay</i>	<i>Gulf of Mexico</i>
<i>heat load</i>	- 40%	- 87%	- 87%
<i>average salinity</i>	+ 0.54 ppt/mo	0	0
<i>design salinity (summer low flow, 25 ppt)</i>	+ 1.9 ppt	0	0
<i>suspended solids:</i>			
<i>re-mix in reject water</i>	+ 1.8 mg/L/mo	0	0
<i>re-mix in Joslin return</i>	+ 1.8 mg/L/mo	+ 3.5 mg/L/mo	+ 3.5 mg/L/mo
<i>off-site disposal</i>	0	0	0

5.2 Potential environmental issues

The alternative offering the greatest economic viability and the simplest permitting requirements is remixing both the reject water and the filtered solids back into the Joslin return flow and discharging to Cox Bay through the existing outfall. This alternative should be given more detailed evaluation in an environmental assessment.

A simple dilution calculation was employed for this evaluation to estimate the impacts in Table 8. While this was adequate to quantify the order of the impact, and to establish that this does not comprise a fatal flaw for the project, more refined calculations will be necessary to better determine specific regional effects of the discharge. The same worst-case method of assuming

no exchange could be applied to Cox Bay, but this is too unrealistic since substantial exchange does occur between Cox Bay (which is really more of a bight than a bay) and the remainder of Lavaca Bay. The recommended approach would be to utilize hydrographic data of tides, salinity, and inflow to determine the exchanges between subsections of Lavaca and Matagorda Bay. Such an approach would be similar to that employed by Ward (1997) for Corpus Christi Bay. This has the considerable advantage of being based solidly on data from the Matagorda Bay system.

If there are areas within the range of impacts from the Joslin/de-sal plant that may be sensitive to salinity or turbidity, e.g. oyster reefs or wetlands habitats, additional analytical studies involving the application of mathematical models may prove necessary. At present, at least three salinity model applications have been made to Matagorda Bay: (1) the finite-difference circulation/salinity model of the Texas Water Development Board (TWDB) developed during the early 1970's, (2) the newer finite-element hydrodynamic and salinity model (TXBLEND) developed by TWDB and applied to Matagorda Bay by the Lower Colorado River Authority (LCRA), and (3) a proprietary version of the Princeton Ocean Model (POM) applied by HydroQual, Inc. as a part of the ALCOA Superfund project. None of these three models has been satisfactorily validated for Matagorda Bay. While a valiant attempt was made by HydroQual in the Superfund project, at present there is no satisfactory operating model for sedimentary processes for Matagorda Bay (much less one that has been validated).

The decision to apply such a sophisticated model does not obviate the recommendation of a rigorous circulation and exchange study based upon measured tides and hydrography. In fact, such a study would provide useful information for model input development and model validation.

The potential impact of the pre-treatment influent filtration on entrained organisms is unknown. For this preliminary analysis, we assume total mortality of these planktonic organisms, and compared the entrained volume to the resource in the area of the turning basin. If entrainment remains a concern, some performance review of the specified filtration strategy may be needed.

Disposal Options 2 and 3 for the reject water will require construction of a pipeline. For present planning purposes, this is assumed to follow a straight-line path across Lavaca Bay, to either Matagorda Bay or the Gulf of Mexico. We note that such a pipeline will require a Department of the Army permit (a.k.a., Section 10/404), administered by the Galveston District Corps of Engineers. This will require adherence to NEPA protocols, possibly including an Environmental Impact Statement and a series of public hearings, as well as the review of the entire project (not just the pipeline) by the U.S. Fish & Wildlife Service, the National Marine Fisheries Service, and the Environmental Protection Agency. I estimate at least a year for the necessary permit application, supporting studies, and agency coordination, probably longer.

The Colorado River diversion project, part of the Corps of Engineers Mouth of the Colorado navigation project, was described in Section 2.2 above. This represents a substantial public investment in a project with one objective: to benefit the environment of Matagorda Bay by introducing additional freshwater inflow. While no beneficial response to this project has yet been demonstrated, and the project is controversial, its objective may be perceived as being threatened by the proposed de-sal plant removing freshwater from Lavaca Bay.

Discharge Option 3, entailing the piping of reject water (and perhaps filtered solids) for discharge into the Gulf of Mexico beyond the surf zone would appear on the face to be the least-impact of the three discharge options. While the content of this discharge will be only natural substances (sea salts and, perhaps, bay muds) and their dilution in the well-mixed volume of the Gulf will entail a negligible mixing zone, this alternative can be expected to meet with political resistance, deriving from the rarity of ocean waste disposals in the Gulf of Mexico shorefront.

Option 1, in contrast, will require only amending the TPDES discharge permit. (There may also be some additional permitting involving diversion of water, its distribution, or re-designating the facility, but this do not involve the environmental impacts of the discharge.) All of the necessary permit negotiations and agency oversight should be consummated at the state level.

References

- Bouma, A. and W. Bryant, 1969: Rapid delta growth in Matagorda Bay, Texas. *Lagunas costerdos, un symposio*, UNAM-UNESCO, Mexico, D.F., pp. 171-189.
- Clay, C., 1949: The Colorado River raft. *Southwestern Historical Quarterly* 52, pp. 410-426.
- Di Toro, D., 1978: Optics of turbid estuarine waters: approximations and applications. *Water Res.* 12, pp. 1059-1068.
- Haltiner, G., and F. Martin, 1957: *Dynamical and physical meteorology*. New York: McGraw-Hill Book Co.
- Jones, D. and M. Willis, 1956: The attenuation of light in sea and estuarine waters in relation to the concentration of suspended solid matter. *J. Mar. Biol. Assn. U.K.*, 35, pp 431-44.
- Morgan, G., D. Brunkow, and R. Beebe, 1975: *Climatology of surface fronts*. Circ. 122, Illinois State Water Survey, Urbana.
- Moseley, F.N., and B.J. Copeland, 1971: Ecology of Cox Bay, Texas. First Annual Report 1969-70, Central Power & Light Company, Corpus Christi, Texas.
- Moseley, F.N., and B.J. Copeland, 1973: Ecology of Cox Bay, Texas : before and after power plant operations. Interim Report 1969-72, Central Power & Light Company, Corpus Christi, Texas.
- Moseley, F.N., and B.J. Copeland, 1974: Ecology of Cox Bay, Texas, 1969-73. Final Report, Central Power & Light Company, Corpus Christi, Texas.
- Moseley, F.N., B.J. Copeland, L.S. Murray, T.S. Jinette and P.T. Price, 1975: Further studies on the effects of power plant operation on Cox Bay, Texas. Central Power & Light Company, Corpus Christi, Texas.
- Texas Department of Water Resources, 1985: Investigation of the effects of releases of water from Lake Texana, Lavaca River Basin, on August 31 - September 7, 1984. Unpublished report, Engineering & Environmental Systems Section, Planning and Development Division, TDWR, Austin.
- Thornthwaite, C., and J. Mather, 1955: The surface water budget. *Publications in Climatology* 8(1).
- U.S. Corps of Engineers, 1917: Colorado River and raft, miscellaneous papers and reports. Unpublished file, Galveston District.
- U.S. Corps of Engineers, 1977: Mouth of the Colorado River, Texas, General Design Memorandum and Final Environmental Impact Statement. Galveston District.

- van de Kreeke, J., 1985: Stability of tidal inlets—Pass Cavallo, Texas. *Estuarine, Coastal & Shelf Science* 21 (1), pp. 33-43.
- Wadsworth, A., 1966: Historical delatation of the Colorado River, Texas. *Deltas and their geological framework* (M. Shirley, Ed.), Houston Geological Society.
- Ward, G.H., 1980: Frontal-induced hydrographic responses of the Texas bays. *Second Conference on Coastal Meteorology* (Preprint Vol.), pp. 304-307. Boston: American Meteorological Society.
- Ward, G. H., 1982: Pass Cavallo, Texas: Case study of tidal-prism capture. *J. Waterway, Port, Coastal, Ocean Div., ASCE*, 108 (WW4), pp. 513-525.
- Ward, G.H., 1997: *Processes and trends of circulation within the Corpus Christi Bay National Estuary Program Study Area*. Publ. CCBNEP-21, Corpus Christi Bay National Estuary Program, Texas Natural Resource Conservation Commission, Austin, Texas.
- Ward, G.H., R.J. Huston, and W.D. Bergman, 1975: Field studies and mathematical modeling of the Joslin Station discharge in Cox Bay. Doc. No. 7510, Espey, Huston & Assoc., Austin.
- Ward, G. and N. Armstrong, 1980: *Matagorda Bay, Texas: its hydrography, ecology and fishery resources*. Report FWS/OBS-81/52 + appendices, Biological Services Program, U.S. Fish and Wildlife Service, Washington, D.C.
- Ward, G., and N. Armstrong, 1992: *Ambient Water and Sediment Quality of Galveston Bay: Present Status and Historical Trends*. Report GBNEP-22 (4 vols.), Galveston Bay National Estuary Program, Webster, Texas.
- Ward, G. and C. Montague. 1996: Estuaries. Chapter 12 in *Water Resources Handbook*, L. Mays (ed.). New York: McGraw-Hill Book Company.
- Ward, G., and N. Armstrong, 1997: *Ambient water, sediment and tissue quality of Corpus Christi Bay study area, present status and historical trends: Technical report*. Publ. CBNEP-13, Corpus Christi Bay National Estuary Program, Texas Natural Resource Conservation Commission, Austin, Texas.

Appendix

While turbidity has value in itself as a water-quality indicator, our present interest is in its use as a proxy measure of suspended solids. Turbidity is measured with a nephelometer that measures light scattering at 90° from the beam path as an index to the suspension of particulates, and the measurement is reported in Nephelometric Turbidity Units (NTU's), defined to be numerically about the same as Jackson Turbidity Units (JTU's), an intent that is satisfied strictly for calibrations with standard silica suspensions. For the fine silt and clay suspensions typical of Texas bay waters, the two prove to be unequal (and, in fact, quantum jumps in mean turbidity are evident when TPWD changed from JTU to NTU in its coastal data collection). There are no paired measurements of the two from field data, since one or the other is measured but not both, however there are paired measurements of either turbidity measure with Secchi depth from Corpus Christi Bay. Ward and Armstrong (1997) determined an inverse relation between turbidity and Secchi depth from this data which in turn suggested a relation between JTU and NTU turbidity of $JTU = 1.86 NTU$, which they regard as provisional given the noise in the data.

Relating turbidity to suspended solids is unfortunately opaque. The following analysis was presented by Ward and Armstrong (1992). From Mie theory, a relation would be anticipated between suspended particles and the extinction coefficient b of the form

$$b = \sum n_j r_j^2 / 4$$

where n_j is number of particles of mean radius r_j per unit volume. This implies $b = A \cdot TSS$ for TSS the suspended solids concentration. From British coastal waters A lies in the range 0.25-0.50 for TSS in mg/L (Jones and Willis, 1956). Di Toro (1978) found $A=0.40$ for San Francisco Bay. Since turbidity T is proportional to b (some authors assert T in JTU $b \pm 25\%$), we have T proportional to TSS.

The problem is to determine the coefficient of proportionality. This requires paired measurements of TSS and either JTU or NTU. Such paired measurements were obtained from TNRCC data holdings in the Galveston Bay and Corpus Christi Bay systems. From the Galveston Bay data of 1350 measurements, a least-squares regression line forced through a zero intercept of TSS versus JTU proved to have a slope of about 0.93, which is about half the value to be expected from the literature values given above. The same basic linear relation with a slope of about 1.2 was found by Ward and Armstrong (1997) from 856 data points for the Corpus Christi system. The Galveston Bay relation applied to the Corpus Christi data base yields a standard error that is virtually the same. Given the insensitivity of the standard error to the slope of the regression, the larger data base for Galveston Bay, and the fact that this relation is equally consistent with the Corpus Christi data, this is probably as good a proxy relation giving TSS as a function of JTU as we are likely to find.

With the above relation between JTU and NTU, the relation between TSS and NTU is:

$$TSS = 1.73 NTU$$

or with deference to the intrinsic noise in all of this, $TSS \approx 2 NTU$.

APPENDIX C

**CONVENTIONAL SURFACE WATER TREATMENT,
TRANSMISSION, AND DISTRIBUTION COSTS**

1.1 Description of Options

These are two water supply options for diversion of water from near the Gulf Coast in Matagorda County (Region K) and Calhoun County (Region L) to the major municipal demand center of the South Central Texas Region (Region L) that currently depends upon the Edwards Aquifer. Option LNRA-1a involves the diversion of 100,000 acft/yr of desalted water from Matagorda Bay near Point Comfort (Joslin Power Plant) for distribution to municipal systems.

Option LNRA-1b has three water supply sources. In addition to the desalted water from option LNRA-1a, water would be diverted from the Colorado River and Guadalupe River. Figures 1-1 and 1-2 show the locations of the components for options LNRA-1a and LNRA-1b.

Included in option LNRA-1b is diversion of 35,000 acft/yr of Colorado River water purchased by the City of Corpus Christi from the Garwood Irrigation Company. A water supply option is included in the Coastal Bend Regional Water Plan (Region N) for diversion of this Garwood Purchase to Corpus Christi. For this report the Region N water supply option was modified to transfer the Garwood Purchase to a treatment plant near Bloomington then transmission to the major municipal demand center of the South Central Texas Region. The Colorado River diversion site would be located at an existing diversion dam near Bay City. An off-channel reservoir would be needed near Bay City to firm up the supply. A 35.6-mile pipeline would be needed to deliver the raw water to the Texana Pipeline at a point just downstream of Lake Texana. The raw water would be transported in the Texana Pipeline to the existing Texana booster station 1 just east of the Guadalupe River near Bloomington. The raw water would then be transferred to an off-channel reservoir next to a new conventional water treatment plant near Bloomington. This new conventional water treatment plant would be sized for treatment of both the Colorado River and Guadalupe River water.

Also included in option LNRA-1b is diversion of 65,000 acft/yr of Guadalupe River water at the Saltwater Barrier. A water supply option (Option SCTN-16b) is included in the South Central Texas Regional Water Plan (Region L) for diversion of 74,000 acft/yr of water at the Saltwater Barrier for delivery to a water treatment plant at the major municipal demand center of the South Central Texas Region. Option SCTN-16b assumes that a portion of the water will be available from uncommitted supply from Canyon Reservoir and unappropriated streamflow. These assumptions may not materialize and there may actually only be approximately 50,000 acft/yr available from Guadalupe Blanco River Authority (GBRA) and

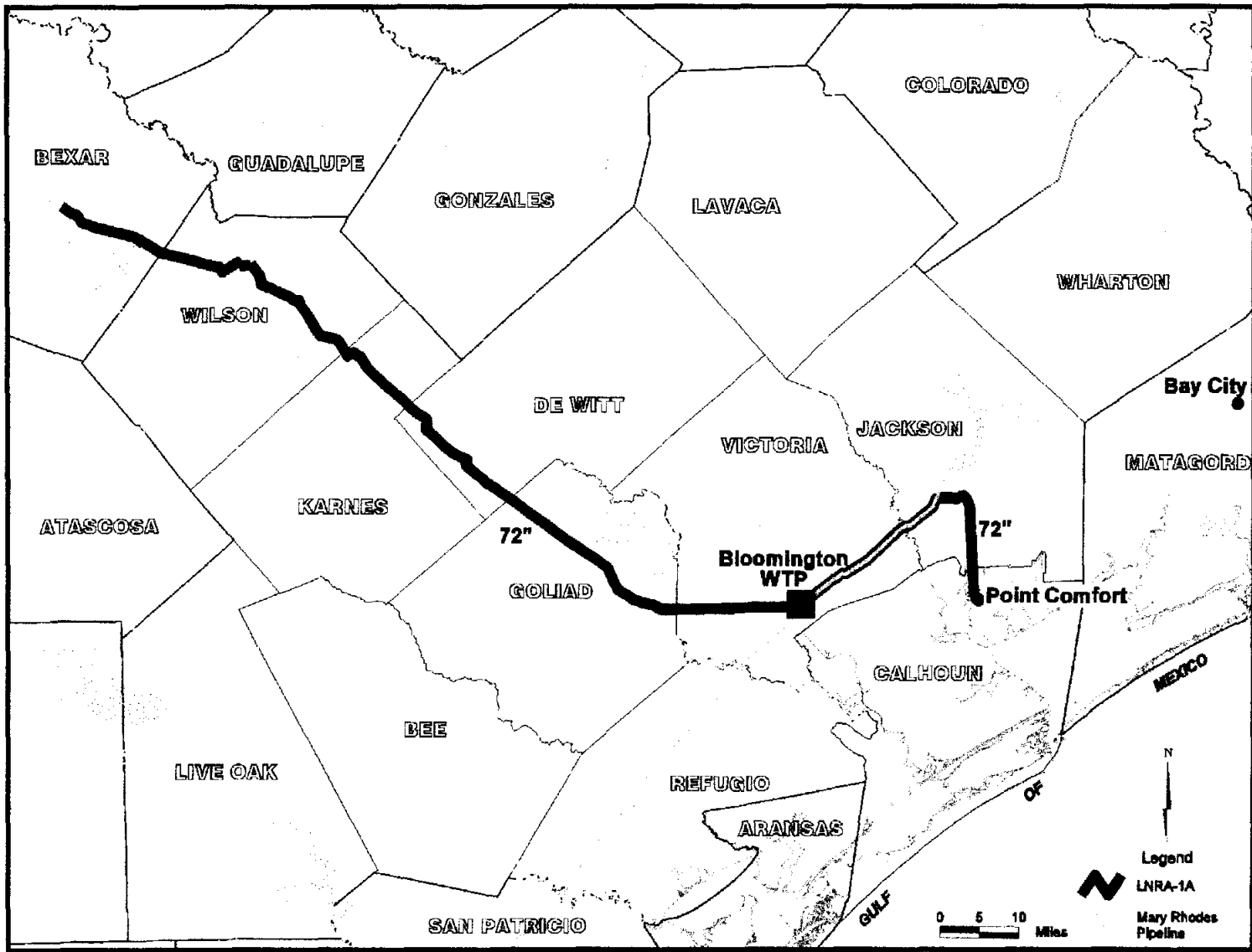

**Figure 1-1. Joslin Power Plant — Bay Water Desalination Study
Option LNRA-1A**

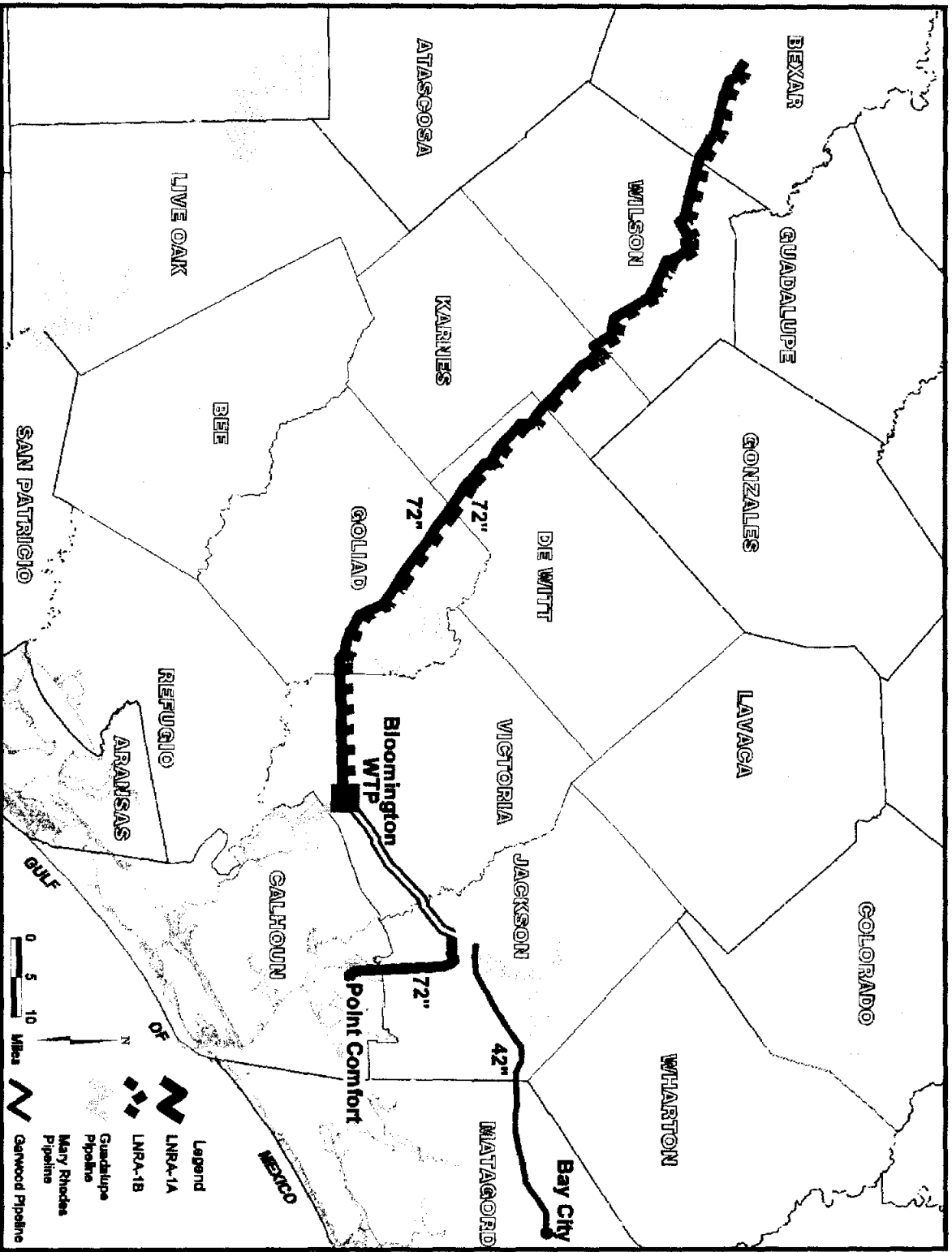

Figure 1-2. Joslin Power Plant — Bay Water Desalination Study
Option LNR-A-1B

Union Carbide Corporation (UCC) water rights. For this report the Region L water supply option was modified to divert 65,000 acft/yr from the saltwater barrier to a conventional water treatment plant near Bloomington. The revised option involves diversion of water from the Guadalupe River at the Saltwater Barrier located 3.5 miles north of Tivoli and transmission to an off-channel reservoir near Bloomington.

Option LNRA-1b also includes conventional water treatment (level 3¹) of the combined flow of 100,000 acft/yr from the Garwood Purchase and the Guadalupe River at a new conventional water treatment plant near Bloomington. The combined flow would be transferred 117 miles to the major municipal demand center of the South Central Texas Region in a 72-inch pipeline for distribution to municipal systems.

1.2 Engineering and Costing

Costs for option LNRA-1b are estimated two ways. First, the costs of the individual components of LNRA-1b are estimated separately. Second, the components are combined into one cost estimate to illustrate efficiencies due to the transmission of a larger total quantity of water in comparison to the smaller projects evaluated by previous reports (SCTN-16b). The separate components of LNRA-1b are:

1. Transmission of 100,000 acft/yr of desalted water from a seawater desalination treatment plant near Point Comfort (LNRA-1a) to the major municipal demand center of the South Central Texas Region.
2. Transmission of 35,000 acft/yr from the Colorado River (Garwood Purchase) to a conventional water treatment plant near Bloomington.
3. Diversion of 65,000 acft/yr from the Guadalupe River to a conventional water treatment plant near Bloomington, conventional water treatment of 100,000 acft/yr combined flow, and transmission of the 100,000 acft/yr to the major municipal demand center of the South Central Texas Region.

1.2.1 Desalted Water (LNRA-1a)

The major facilities required for transmission of the desalinated water from the Point Comfort area to the major municipal demand center of the South Central Texas Region for option LNRA-1a are:

- Pump station near Point Comfort;

¹ Level 3 water treatment is defined as standard conventional treatment used for treating all surface water sources to be delivered to a potable water distribution system.

- 72-inch transmission pipeline from the Point Comfort area to the Texana pipeline route and then along the Texana pipeline route to near the Texana booster station location east of the Guadalupe River near Bloomington;
- Treated water booster station near the existing Texana raw water booster station;
- Transmission pipeline from the Texana booster station to the major municipal demand center of the South Central Texas Region;
- Two treated water booster stations; and
- Connection to municipal systems for distribution.

The route for transmission to the major municipal demand center of the South Central Texas Region is shown in Figure 1-1. Table 1-1 provides a cost listing for delivery of 100,000 acft/yr of desalted water for this option.

1.2.2 Colorado River Water (Garwood Purchase)

Major facilities for transmission of Colorado River water (Garwood Purchase) to a conventional water treatment plant near Bloomington are:

- River surface water intake and pump station near Bay City;
- Transmission pipeline (64-inch) from river to reservoir;
- Off-channel reservoir (8,000 acft);
- Reservoir intake and pump station;
- Transmission pipeline (42-inch) from the reservoir to a terminal storage tank at the Texana Pipeline intake pumping station;
- Junction piping and appurtenances to tie the Garwood Pipeline to the Texana Pipeline;
- Add pumps to the Texana pump station; and
- Junction piping and appurtenances to take off the Garwood water at Texana Booster 1.

Table 1-2 provides a cost listing for delivery of the Garwood Purchase. The river intake and pump station are sized to deliver up to 150 cfs through a 5.9-mile, 64-inch diameter pipeline to an off-channel storage facility. The off-channel reservoir is sized and costed with a storage capacity of 8,000 acft. The purchase of 35,000 acft/yr from Corpus Christi is included at a rate of \$46 per acft. This water purchase cost is based on the cost to purchase the Garwood water right at a one-time purchase price of \$583 per acft for a total cost of \$20,405,000 amortized at 6% interest over 30 years with interest during construction.

**Table 1-1.
Cost Estimate Summary for
Transporting Point Comfort Desalinated Water² (LNRA-1a)
(Second Quarter 1999 Prices)**

<i>Item</i>	<i>Estimated Costs for Facilities</i>
Capital Costs	
Pump Station (89.3 MGD)	\$5,994,000
Transmission Pump Stations (3)	28,417,000
Transmission Pipeline (72-inch dia.; 156 miles)	205,155,000
Water Treatment Plant (89.3 MGD) – Desalination Plant at Joslin	0
Connection to Municipal System for Distribution	<u>94,189,000</u>
Total Capital Cost	\$333,755,000
Engineering, Legal Costs and Contingencies (35 percent)	\$100,127,000
Environmental & Archaeology Studies and Mitigation	3,928,000
Land Acquisition and Surveying (772 acres)	7,286,000
Interest During Construction (2 years)	<u>35,608,000</u>
Total Project Cost	\$480,704,000
Annual Costs	
Debt Service (6 percent for 30 years)	\$34,923,000
Operation and Maintenance:	
Intake, Pipeline, Pump Station	3,767,000
Seawater Desalination Treatment Plant	0
Seawater Desalination Treatment Plant Energy Costs (kWh @ \$_ per kWh)	0
Pumping Energy Costs (229,683,216 kWh @ \$0.06 per kWh)	<u>13,781,000</u>
Total Annual Cost	\$52,471,000
Available Quantity of Yield (acft/yr)	100,000
Annual Cost of Transporting Desalinated Water (\$ per acft)	\$525
Annual Cost of Transporting Desalinated Water (\$ per 1,000 gallons)	\$1.61

² Table 1-1 does not include costs for the seawater desalination treatment plant or concentrate disposal.

Table 1-2.
Cost Estimate Summary for
Garwood Water and Pipeline to Bloomington Water Treatment Plant
(Second Quarter 1999 Prices)

<i>Item</i>	<i>Estimated Costs for Facilities</i>
Capital Costs	
Diversion Facilities (64-inch dia., 150 cfs)	\$11,526,000
Off-Channel Reservoir (8,000 acft, 580 acres)	9,344,000
Intake and Pump Station (31.3 MGD)	6,227,000
Transmission Pipeline (42 in dia., 35.6 miles)	24,521,000
Storage Tank	1,129,000
Other (Access Road)	<u>406,004</u>
Total Capital Cost	\$53,153,004
Engineering, Legal Costs and Contingencies (35 percent)	\$16,413,000
Environmental & Archaeology Studies and Mitigation	1,623,000
Land Acquisition and Surveying (787 acres)	3,025,000
Interest During Construction (2 years)	<u>5,938,000</u>
Total Project Cost	\$80,152,004
Annual Costs	
Debt Service (6 percent for 30 years)	\$4,278,000
Reservoir Debt Service (6 percent for 40 years)	991,000
Operation and Maintenance:	
Intake, Pipeline, Pump Station	627,000
Dam and Reservoir	140,000
Pumping Energy Costs (20,742,376 kWh @ \$0.06 per kWh)	1,245,000
Texana Pipeline Cost (Separate 42-inch Pipeline = \$3,500,000)	1,050,000
Purchase of Garwood Water (35,000 acft/yr @ \$46/acft)	<u>1,610,000</u>
Total Annual Cost	\$9,941,000
Available Quantity of Yield (acft/yr)	35,000
Annual Cost of Raw Water and Transport to Bloomington (\$ per acft)	\$284
Annual Cost of Raw Water and Transport to Bloomington (\$ per 1,000 gallons)	\$0.87

1.2.3 *Guadalupe Diversion and Bloomington Treatment Plant*

Major facilities for diversion of Guadalupe River water, conventional water treatment plant near Bloomington, and transmission to the major municipal demand center of the South Central Texas Region are:

Guadalupe Facilities:

- Surface water intake and pump station near the Salt Water Barrier;
- Off-channel dam and reservoir (20,000 acft);

Facilities for Both Garwood and Guadalupe:

- 100,000 acft/yr conventional water treatment plant (Level 3);
- Treated water transmission pipeline (72-inch) from treatment plant to the major municipal demand center of the South Central Texas Region; and,
- Connection to municipal systems for distribution.

The river intake and pump station are sized to deliver up to 251 cfs through a 12.6-mile, 96-inch diameter pipeline to an off-channel storage facility near Bloomington, with a 5 percent downtime allowance. The off-channel reservoir is sized and costed with a storage capacity of 20,000 acft. The purchase of 65,000 acft/yr (50,000 acft/yr existing run-of-river rights and 15,000 acft/yr of stored water from Canyon Reservoir) is included at a rate of \$61 per acft. Table 1-3 provides a cost listing for this option.

1.2.4 *Combined LNRA-1b*

The combined LNRA-1b option includes all three sources outlined in Section 1.2.1 through 1.2.3. The three sources are combined for transmission of 200,000 acft/yr to the major municipal demand center of the South Central Texas Region.

Table 1-4 provides a cost listing for the combined LNRA-1b option. Cost efficiencies realized include:

- Combined easement of 60 feet for both pipelines as opposed to each pipeline costed with a 40-foot easement;
- One larger pump station at the conventional water treatment plant;
- Single larger pump stations and storage tanks at each of the booster stations; and,
- Economy of scale for connection to municipal systems for distribution.

Table 1-3.
Cost Estimate Summary for Guadalupe Water and Diversion, Bloomington Conventional
Water Treatment Plant, and Transmission Pipeline to Major Municipal Demand Center
(Second Quarter 1999 Prices)

<i>Item</i>	<i>Estimated Costs for Facilities</i>
Capital Costs	
Diversion Facilities (96" dia., 251 cfs)	\$27,800,000
Off-Channel Reservoir (20,000 acft, 1,218 acres)	13,626,000
Intake and Pump Station (89.3 MGD)	11,655,000
Transmission Pump Station(s) (2)	17,953,000
Transmission Pipeline (72 in dia., 117 miles)	158,857,000
Water Treatment Plant (89.3 MGD)	56,100,000
Connection to Municipal System for Distribution	<u>94,189,000</u>
Total Capital Cost	\$380,180,000
Engineering, Legal Costs and Contingencies (35 percent)	\$124,063,000
Environmental & Archaeology Studies and Mitigation	4,850,000
Land Acquisition and Surveying (1,873 acres)	7,693,000
Interest During Construction (2 years)	<u>41,344,000</u>
Total Project Cost	\$558,130,000
Annual Costs	
Debt Service (6 percent for 30 years)	\$38,851,000
Reservoir Debt Service (6 percent for 40 years)	1,552,000
Operation and Maintenance:	
Intake, Pipeline, Pump Station	3,581,000
Dam and Reservoir	204,000
Water Treatment Plant	7,076,000
Pumping Energy Costs (198,627,630 kWh @ \$0.06 per kWh)	12,251,000
Purchase of Guadalupe Water (65,000 acft/yr @ \$61/acft)	<u>3,965,000</u>
Annual Cost of Guadalupe Water Source, Treatment, and Transmission	\$67,480,000
Annual Cost of Garwood Water and Transfer to Bloomington	<u>9,940,563</u>
Total Annual Cost	\$77,420,563
Available Project Yield (acft/yr)	100,000
Annual Cost of Water (\$ per acft)	\$774
Annual Cost of Water (\$ per 1,000 gallons)	\$2.38

**Table 1.4 Cost Estimate Summary for
Combined Point Comfort, Garwood, Guadalupe, Bloomington Total ³ (LNRA-2b)
(Second Quarter 1999 Prices)**

<i>Item</i>	<i>Estimated Costs for Facilities</i>
Capital Costs	
Diversion Facilities (96" dia., 251 cfs)	\$27,800,000
Off-Channel Reservoir (20,000 acft, 1,218 acres)	13,626,000
Pump Station at Joslin (89.3 MGD)	5,994,000
Intake and Pump Station at Bloomington (178.6 MGD)	15,945,000
Transmission Pump Stations (2)	26,149,000
Transmission Pipeline (72 in dia., 273 miles)	364,012,000
Water Treatment Plant (89.3 MGD)	56,100,000
Distribution	<u>161,879,000</u>
Total Capital Cost	\$671,505,000
Engineering, Legal Costs and Contingencies (35 percent)	\$215,769,000
Environmental & Archaeology Studies and Mitigation	5,822,000
Land Acquisition and Surveying (2,352 acres)	9,824,000
Interest During Construction (2 years)	<u>72,234,000</u>
Total Project Cost	\$975,154,000
Annual Costs	
Debt Service (6 percent for 30 years)	\$69,147,000
Reservoir Debt Service (6 percent for 40 years)	1,552,000
Operation and Maintenance:	
Intake, Pipeline, Pump Station	6,730,000
Dam and Reservoir	204,000
Water Treatment Plant	7,076,000
Pumping Energy Costs (433,858,777 kWh @ \$0.06 per kWh)	26,032,000
Purchase of Guadalupe Water (65,000 acft/yr @ \$61/acft)	<u>3,965,000</u>
Annual Cost Guadalupe Source, Bloomington, and Point Comfort Desalt	\$114,706,000
Annual Cost Garwood Water and Transfer to Bloomington	<u>9,940,563</u>
Total Annual Cost	\$124,647,006
Available Project Yield (acft/yr)	200,000
Annual Cost of Water (\$ per acft)	\$623
Annual Cost of Water (\$ per 1,000 gallons)	\$1.91

³ Table 1-4 does not include costs for the seawater desalination treatment plant or concentrate disposal.

The differences between the separate cost estimates for each component of LNRA-1b versus the combined cost estimate are shown in Table 1-5.

Table 1.5.⁴
Summary of Cost Estimates
for Separate LNRA-1b Components and Combined LNRA-2b
(Second Quarter 1999 Prices)

	<i>Capital Cost</i>	<i>O&M</i>	<i>Total Annual Cost</i>	<i>\$/acft</i>	<i>\$/1000 gal</i>
LNRA-1a (Joslin Desalt)	\$480,704,427	\$17,548,410	\$52,471,063	\$525	\$1.61
Separate Garwood and SWB	\$558,131,137	\$27,076,605	\$77,420,295	\$774	\$2.38
Total Separate	\$1,038,835,564	\$44,625,016	\$129,891,359	\$649	\$1.99
LNRA-1b combined	\$975,153,339	\$44,007,107	\$124,647,006	\$623	\$1.91

⁴ Costs do not include seawater desalination treatment plant and concentrate disposal.

APPENDIX D

LEGAL, INSTITUTIONAL AND PERMITTING ISSUES

LEGAL AND INSTITUTIONAL ISSUES OF THE LAVACA NAVIDAD DESALINATION PROJECT

Due to the merger of Central and South West Corporation and American Electric Power Company, Central Power and Light Company is faced with selling their Joslin Plant. This creates an opportunity to acquire the power plant and dedicate it to the Lavaca Navidad Desalination Project. The restructuring of the electric power industry by the Texas Legislature during the 96th Legislative Session also presents an opportunity for the desalination project sponsors to save a significant amount of money in acquiring power for the project by potentially eliminating both the transmission utility and retail electric provider in its acquisition of electric power through the development of a political subdivision corporation or a contract with the General Land Office. However, the merger of the two power companies also complicates the acquisition because the Joslin Plant is prohibited from being sold until June 2000, which makes planning the desalination project difficult.

The development of the Lavaca Navidad Desalination Project poses several legal issues. The first issue involves the actual design and construction of the facility. Typically, a governmental entity is required by the state's procurement laws to select the design of the project based on qualifications of the provider and the construction based on the lowest bid. Generally, the bidding of a design-build team is prohibited. However, the creation of a development corporation among the public and private sponsors of the desalination project is an option that may be pursued to build the project without violating state procurement laws.

Other legal issues to be considered in the acquisition of the Joslin Plant are the environmental permits that will be required for the desalination project. The Central Power & Lighting Company's water rights permit would have to be amended to allow other purposes of use and an interbasin transfer to supply water to San Antonio. The power plant's TPDES wastewater discharge permit would have to be amended to reflect the new waste. The U. S. Corps of Army Engineers will have to grant a Section 404 permit with 401 certification by the Texas Natural Resource Conservation Commission (TNRCC) to construct the pipeline. And the TNRCC would also have to verify that the proposed changes in the water permit are consistent with the Texas Coastal Management Program.

I. Impact of Electric Utility Restructuring on Availability and Suitability of the Joslin Plant.

A. Overview of restructuring

During the 1999 session, the Texas legislature restructured the electric utility industry. The legislation is referred to as Senate Bill 7 (SB 7). Under the restructuring plan, electric suppliers will compete to directly serve most residential, governmental, commercial, and industrial customers, and these customers will be able to buy electricity from whomever they choose.

Historically, each electric utility was granted a service territory. All of the customers who wanted electric service in that service territory had to use that utility. Thus, the utility had a monopoly because customers had no choice in selecting their electric utility. The only way that a customer

**LEGAL AND INSTITUTIONAL ISSUES OF THE LAVACA NAVIDAD
DESALINATION PROJECT (Continued)**

could be served by a different electric utility was by moving into another electric utility's service territory. In a few isolated areas of the State, for example, Lubbock, two or three electric utilities had overlapping service territories. In those rare instances, the customers had a limited choice about their electric utility.

Although the customer views the electric utility as a single business operation that brings electricity to the customer's residence or business, the utility's operation is a combination of activities. These activities can be divided into four functions:

1. **generation (power plants):** the electric utility uses its power plants to generate electricity or the electric utility buys electricity from some other company that generated the electricity;
2. **transmission lines:** the electric utility uses transmission lines to send electricity from the power plant to distribution centers (or substations) close to where the customers are located;
3. **distribution lines:** the electric utility uses distribution lines to send the electricity from the distribution substations to the customer's residence or business; and
4. **metering and billing:** the electric utility uses a meter to record the customer's consumption and then bills the customer.

This traditional market structure will change on January 1, 2002. At that time, the electric utilities will be broken apart and these functions will be performed by separate companies. Customers will then be able to choose their electric providers. This competition for customers is referred to as **customer choice**. The new industry structure will be organized as follows.

- **Retail electric provider (REP).** Electric customers will no longer be served by their current electric utility because the utility will no longer exist in its current form. Instead, customers will obtain electric service from a new type of company, a retail electric provider. The retail electric provider will not own any generating plants or any transmission or distribution lines. Consequently, the retail electric provider will be responsible for obtaining the electricity from a separate company that generates or markets electricity, and for having the electricity delivered from the power plant to the customer.
- The **transmission lines** and the **distribution lines** will be owned and operated by a regulated utility whose only business will be the transmission and distribution functions. Instead of having a combined transmission and distribution utility, it is permissible to have two separate utilities, one of which is the transmission utility, and the other of which is the distribution utility.
- The **metering and billing** functions will not become competitive in 2002, but

**LEGAL AND INSTITUTIONAL ISSUES OF THE LAVACA NAVIDAD
DESALINATION PROJECT (Continued)**

instead will become competitive over time. Until metering and billing become competitive, the transmission and distribution utility will provide the metering and billing functions.

- **Generation** will be sold at wholesale—not at retail. In other words, generators cannot sell electricity directly to residential, commercial, industrial, and governmental customers. Some examples of the types of companies that can sell generation are: a power generation company; a power marketer; and an exempt wholesale generator.

Some electric utilities are exempt from the industry restructuring. These utilities' customers will not be able to choose their electric providers. Instead they will continue to be served by their existing utility. The following electric utilities are exempt from the restructuring.

- **Municipally-owned electric utilities and electric cooperatives** are not required to restructure their operations on January 1, 2002 or at any other time. At its discretion, however, the governing board of a municipally-owned utility or an electric cooperative may opt in to industry restructuring at anytime. The decision to opt in is irreversible.
- El Paso Electric Company and Southwestern Public Service Company are on slightly different timetables from the rest of the State.

B. Special purchasing and procurement options available to LNRA

1. The General Land Office (“GLO”) is authorized to sell electricity to certain governmental entities

Chapter 35 of the Texas Utilities Code was recently amended to allow the Commissioner of the General Land Office (GLO), acting on behalf of the state, to sell or otherwise convey power generated from royalties taken in kind directly to a public retail customer. TEX. UTIL. CODE ANN. § 35.102 (Vernon 1999). The power is to be sold first to public retail customers that are agencies of the state, institutions of higher education, or public school districts. *See id.* The remainder of the power, if any, may be sold to public retail customers that are political subdivisions of the state. *See id.* The GLO may not sell electricity to customers of a municipally owned electric utility or an electric cooperative that has not adopted customer choice. *See id.* § 35.104. Furthermore, the GLO is capped at selling electricity that equals no more than 2.5% of the total retail load per territory in such areas. *See id.* The GLO will not generate electricity, or build, or own any electric facilities. *See id.* § 35.103. A contracted agent or energy service provider and the incumbent utility will conduct all electric and utility related business. The GLO will simply supply gas to the electric service provider and contract for service with customers. *See id.* § 35.106.

The provisions of Chapter 35 appear to be applicable to the desalination project, although the GLO's support probably cannot be geared directly to a development corporation, as it is not a political

**LEGAL AND INSTITUTIONAL ISSUES OF THE LAVACA NAVIDAD
DESALINATION PROJECT (Continued)**

subdivision and therefore not a "public retail customer" for purposes of the Chapter.

2. Political subdivision corporations

Senate Bill 7 creates a new type of political entity called a political subdivision corporation. Under this legislation, two or more political subdivisions may join together to create a political subdivision corporation to act as their agent to buy electricity and related services. The political subdivision corporation can buy electricity either for the use of the political subdivisions that created it or for the citizens of the political subdivisions.

For this purpose, a political subdivision is defined as follows: a county, municipality, hospital district, or any other political subdivision that is receiving electric service from an entity that has implemented customer choice. Given this definition, any political subdivision that is a customer of a municipally-owned electric utility or an electric cooperative that has not opted in for customer choice cannot create and make use of a political subdivision corporation. Additionally, in light of this definition, the political subdivision corporation cannot purchase electricity and related services until customer choice is offered in an existing electric utility's service territory, which is January 1, 2002 at the earliest.

The political subdivisions that join together to create the corporation do not have to be geographically contiguous or the same type of political subdivision. For example, water or conservation districts in South Texas, in East Texas, and in Central Texas can act together to create a political subdivision corporation. Likewise, a county, a school district, and a conservation district can act to form a political subdivision corporation. The corporation may appear on behalf of its incorporating political subdivisions before any governmental agency or regulatory authority, the Texas legislature, and the courts. The corporation has the powers of any other non-profit corporation incorporated under the Texas Non-Profit Corporation Act.

The political subdivisions that join together can create more than one political subdivision corporation. For example, each corporation might be organized to serve a different service or product related to electricity. One corporation might be a retail electric provider, and another corporation might own and operate a power plant.

Further, the political subdivision corporation may buy electricity on behalf of individual citizens of the incorporating political subdivisions who have voluntarily agreed to aggregate their electricity purchases. The citizens must affirmatively request to have their electricity purchases handled by the political subdivision corporation. The political subdivisions and the corporation cannot mandate that citizens participate in the aggregation activity.

LEGAL AND INSTITUTIONAL ISSUES OF THE LAVACA NAVIDAD DESALINATION PROJECT (Continued)

II. Impact of the Merger Between Central and South West Corporation (CSW) and American Electric Power Company, Inc. (AEP).

A. Background about the merger

Central and South West Corporation (CSW) and American Electric Power Company, Inc. (AEP) recently merged. The surviving entity is AEP. Consequently, the AEP personnel ultimately are in charge of activities in Texas. Thus the CSW personnel that LNRA has dealt with will have to clear their decisions with a new set of executives at AEP. CSW was based in Dallas and owned four utility operating companies: Central Power and Light Company (CPL), Public Service Company of Oklahoma, Southwestern Electric Power Company, and West Texas Utilities Company. These operating companies serve approximately 1.7 million customers in Texas, Arkansas, Louisiana, and Oklahoma. AEP is based in Columbus, Ohio. In addition to the four CSW operating companies, AEP owns seven utility operating companies,¹ which serve almost three million customers in parts of Ohio, Michigan, Indiana, Kentucky, West Virginia, Virginia, and Tennessee.

B. Texas Public Utility Commission's (PUC) order approving the merger

In order to complete the merger, CSW and AEP had to receive orders from various state and federal regulators, including the PUC. The PUC proceeding was resolved through a settlement among the following parties: CSW and AEP; the Office of Regulatory Affairs, which is the PUC's litigation staff; the Office of Public Utility Counsel; certain Cities served by the CSW operating companies (Abilene, Corpus Christi, McAllen, Victoria, Big Lake, Vernon, and Paducah); the State of Texas, which is the Attorney General's office representing State agencies that are customers of the CSW operating companies; the Texas Industrial Energy Consumers; Low Income Intervenors; various electric cooperatives; and various potential competitors.

C. The PUC's order requires CSW to sell the Joslin Unit and to use the gain on sale for a specific purpose

Among other things, the settlement requires CSW and AEP to sell certain power plants and to use the gain on sale of CPL's power plants, which is the amount over book value, to reduce the dollar value of CPL's unrecovered investment in the South Texas Project, which is a nuclear power plant. CPL's Joslin Unit 1 is one of the plants that is required to be sold under the settlement agreement.

The dollar amount of the gain on sale takes on significance due to certain restructuring provisions in Senate Bill 7. Under that legislation, if industry restructuring causes certain generation-related

¹ The seven operating companies are: Appalachian Power Company; Columbus Southern Power Company; Indiana Michigan Power Company; Kentucky Power Company; Kingsport Power Company; Ohio Power Company; and Wheeling Power Company.

**LEGAL AND INSTITUTIONAL ISSUES OF THE LAVACA NAVIDAD
DESALINATION PROJECT (Continued)**

assets, such as a nuclear power plant, to become uneconomic, then the utility is allowed to recover the loss on that asset by imposing a surcharge on the customers of the transmission and distribution utility. To the extent that the utility is able to maximize its gain from selling its generating facilities, then the surcharge will be lower than it otherwise would be. Due to this aspect of Senate Bill 7 and the settlement agreement that specifically uses the Joslin gain on sale to reduce the surcharge, CPL has taken the position that it must put the Joslin unit up for competitive bids in order to maximize the proceeds from the sale. In CPL's view, if it fails to receive competitive market value for Joslin, then it is subject to action by the PUC and the parties to the settlement agreement for violating the spirit, if not the intent, of the settlement agreement and to a PUC prudence review for non-compliance with Senate Bill 7.

Consequently, CPL is reluctant to sell Joslin without having first tested the market and having documented that it maximized the gain on sale.

D. Restrictions on the timing of the sale

There are potential restriction on how long CSW and AEP must wait before selling the Joslin unit. CSW and AEP have structured the merger so that it is a non-taxable transaction. Pre-merger, CSW's asset value is approximately 60% of AEP's asset value. Thus, each share of pre-merger CSW common stock will be exchanged for .6 AEP shares. Consequently, the ownership interests of CSW and AEP shareholders are being pooled in a manner that preserves the relative pre-merger ownership interest of each share of CSW and AEP common stock. This is referred to as the "pooling of interest" method of accounting. Under the Internal Revenue Code and Securities and Exchange Commission regulations, the pooling of interest method results in no taxable event to AEP and CSW shareholders because assets are not being liquidated in order to pay special dividends or to increase retained earnings.

In order to comply with the pooling of interests method, AEP (the surviving corporation) cannot sell assets for twenty-four months after the merger closes, other than the types of routine sales that occur in the ordinary course of business or sales that were ordered by a regulatory authority as a condition of approving the merger. The Securities and Exchanges Commission ruled that the PUC did not require the sale of certain power plants as a condition of approving the merger, thus, AEP would violate the pooling of interests method if it were to sell the Joslin unit within twenty-four months after the merger closed. Therefore, as a general matter, AEP cannot sell the Joslin unit until June, 2002.

As mentioned, AEP has some latitude to make routine sales of assets. In order to comply with the pooling of interests method, however, the totality of sales being made for some period before the merger closed and during the twenty-four month period after closing must be of immaterial value compared to the total corporate asset value. Thus, one issue is whether the sale of the Joslin unit

LEGAL AND INSTITUTIONAL ISSUES OF THE LAVACA NAVIDAD DESALINATION PROJECT *(Continued)*

would pass the immateriality test. In order to answer this question, LNRA would need to obtain additional information from AEP. Based on a preliminary discussion, however, it appears that CPL has sold assets within the applicable time period and may well have reach the material level.

Another issue is what types of transactions AEP can enter into regarding the Joslin unit within twenty-four months after closing. For instance, can AEP sell an option to purchase the unit at a specified price, but not complete the sale until the twenty-four month period has elapsed? Another example is whether AEP can enter into a lease-purchase agreement that maintains AEP's ownership during the twenty-four month period. In order to answer whether these types of transactions are allowable, LNRA would need more information from AEP. A preliminary discussion, however, indicates that the likely answer may be that these types of transactions would violate the pooling of interests method. But further inquiry may reveal a creative way to comply with the pooling of interests method and still serve LNRA's purpose.

III. Implications of Industry Restructuring and CSW Merger on Use of the Joslin Plant for Desalination.

The combination of CSW's merger with AEP and the PUC's order approving the merger create a clear problem. The Joslin plant must be sold, likely through a competitive bidding process, and that sale can occur no sooner than June 2002. Thus, planning in the interim is complicated because both future ownership of the facility and the ability to make plans based on its current configuration and ownership are uncertain. At the same time, an opportunity is created for sponsors of the desalination project to acquire the power plant and dedicate it to the desalination project.

The restructuring of the electric power industry, on the other hand, presents advantageous possibilities for significant savings in acquiring power for the desalination facility. It is possible, either through contract with GLO or by forming a political subdivision corporation, that sponsors of the project (two or more political subdivisions) could eliminate both the transmission utility and retail electric provider in its acquisition of electric power. Because stranded costs of the electric utilities are captured through the transmission utilities, this could represent a significant savings.

Again, however, timing is an issue. Political subdivision corporations cannot begin to function until January 1, 2002.

Given time required for completion of the SB 1 planning process, a delay until 2002 may not be unworkable. Execution of contracts, financing, and construction of facilities could not be completed prior to 2002, even without the restriction of the merger and power industry restructuring. The primary difficulty is presented by the inability to develop the project in the interim. Potential means to address the uncertainty created by the Joslin plant's 2002 sale include:

**LEGAL AND INSTITUTIONAL ISSUES OF THE LAVACA NAVIDAD
DESALINATION PROJECT (Continued)**

- (1) Obtaining legislative authorization or authorization from the PUC to make commitments regarding sale of the Joslin plant before 2002. Presumably this would entail providing some assurance that the full value of the Joslin plant would be captured, in order to reduce stranded costs for the ratepayers, by the anticipated sale.
- (2) Obtaining legislative or PUC authorization to substitute another plant for the Joslin plant on the PUC list of plants that must be sold. This would allow AEP to retain ownership of the plant and deal with desalination plant sponsors directly, prior to 2002.
- (3) Enter long term contracts or leases with AEP, regarding siting of the desalination facility and power supply, that would bind the future purchaser of the Joslin plant. Again, the PUC would likely have to be satisfied that such an arrangement would not impair the value of the Joslin plant for future purchasers.
- (4) Enter a long term lease for use of the 200 acres adjacent to the Joslin plant and rely upon the economies of power acquisition under SB 7 (GLO purchase and/or political subdivision corporation) to ensure that power could be acquired at a reasonable cost.

In summary, restructuring the power industry and CSW's merger present significant challenges, none of which appear fatal at this time, and significant opportunities for the desalination project.

IV. Lavaca Navidad Desalination Project - Legal Issues

The desalination project could involve several different public and private entities, potentially including the Lavaca Navidad River Authority, the Texas Water Development Board, the San Antonio Water System, Bexar Metropolitan Water District, the City of Corpus Christi, American Electric Power Co. (successor to CP&L), and U. S. Filter. The partnership of public and private entities poses a legal dilemma if the project will be built using a design-build-operate approach. Under a design-build contract, the owner contracts with a single party for both the design and the construction of the project. The legal obstacle is that in Texas, most governmental entities are prohibited by procurement laws from awarding design-build contracts and required to award the construction contract through a bidding process. However, if a design-build approach is preferred over design-bid-build construction, the involved parties may form a development corporation that is not subject to state procurement laws.

A. Award of Design-Build Contracts

In Texas traditionally, an owner of a construction project would hire an engineer to design the facility and then circulate the completed plans to several contractors for competitive bidding. Under a design-build approach, the same entity both designs and constructs the facility. Advantages of

LEGAL AND INSTITUTIONAL ISSUES OF THE LAVACA NAVIDAD DESALINATION PROJECT *(Continued)*

using the design-build approach include shortened project delivery time due to the ability to commence construction prior to completion of the design and the single point responsibility of the design builder, who has full responsibility for the outcome of the project. Moreover, if the design bid contractor is a project participant, with financial incentives for economical construction of the project, the design-build process can allow additional flexibility to achieve those economies. Although there is little empirical data on the actual cost advantages of a design-build versus design-bid-build construction, a study conducted by the Construction Industry Institute found that design-build had the best performance in minimizing cost growth. The Construction Industry Institute Design-Build Research Team, Project Delivery Systems: CM at Risk, Design-Build, Design-Bid-Build, Research Summary 133-1, December 1997. Under this study, the median cost growth for design-build projects was 2.37 percent, less than half the result of design-bid-build projects at 4.83 percent. *Id.* at 6. The most common reason for achieving the contracted cost was having the ability to have construction involvement early in the process. *Id.* at 7.

Disadvantages of the design-build structure may include a loss of checks and balances between the designer and the builder, less owner control because the designer reports to the builder and not the owner, difficulty obtaining competitive bids, and institutional obstacles.

The institutional obstacle in Texas to design-build contracts is that political subdivisions and other governmental entities have traditionally been precluded from awarding design-build contracts under the Professional Services Procurement Act. *See* TEX. GOV. CODE § 2254.003 (Vernon 1993). Under this Act,

(a) A governmental entity may not select a provider of professional services or a group or association of providers or award a contract for the services on the basis of competitive bids submitted for the contract or for the services, but shall make the selection and award:

- (1) on the basis of demonstrated competence and qualifications to perform the services; and
- (2) for a fair and reasonable price.

Id.

Architects and professional engineers are providers of professional services as defined by the statute. TEX. GOV. CODE §2254.002(2). Therefore, most governmental entities are prohibited from awarding a contract for architectural services, engineering services, or any other service specified in the act, on the basis of competitive bidding. *See* Op. Tex. Att'y Gen. No. JM-1189 (1990). As a result of this procurement law, the governmental entities involved in the desalination project lack the authority to make a contract for the construction of public works under the design-build concept when the resulting contract is awarded pursuant to competitive bidding and includes architectural or engineering services as a component of the contract. *See id.*

**LEGAL AND INSTITUTIONAL ISSUES OF THE LAVACA NAVIDAD
DESALINATION PROJECT (Continued)**

B. Public/Private Partnership Solution

The public and private entities involved in the desalination project could form a development corporation to employ the design-build method of construction without violating Texas procurement laws. Development corporations, although comprised of or formed by political subdivisions or other governmental entities, are not considered to be "political subdivisions," and are thus not subject to the laws and regulations governing political subdivisions. *See* TEX. REV. CIV. STAT. ANN. art. 5190.6, § 22 (Vernon 1987) (stating that a development corporation is "not intended to be and shall not be a political subdivision . . . within the meaning of . . . the laws of this state"); Op. Tex. Att'y Gen. No. JC-109 (1999). Consequently, a development corporation is not precluded by the Professional Services Procurement Act from awarding design-build contracts.² *Cf. id.* (finding Section 272.001 of the Texas Local Government Code, providing notice and bidding requirements to be followed by political subdivisions selling real property, inapplicable to development corporations because they are not "political subdivisions").

Under the Texas Development Corporation Act of 1979 (the Act), any number of persons (not less than three) that are at least 18 years of age and a qualified elector of either a city, county, or conservation and reclamation district established under Article 16, Section 59 of the Texas Constitution may file an application requesting the creation of a corporation with the governing body of the governmental unit. TEX. REV. CIV. STAT. ANN. art. 5190.6, § 4(a) (Vernon 1987). The governmental unit may authorize creation of a corporation, providing the corporation specifies a public purpose to be furthered on behalf of the unit, for example, the promotion and development of industrial and manufacturing enterprises to promote and encourage employment and the public welfare).

Some of the general powers and duties of a development corporation are as follows:

- (1) A development corporation may issue bonds to finance the cost of "projects," which include within their definition "facilities for the furnishing of water to the general public." (Section 2(11)(A))
- (2) A development corporation has those powers of a nonprofit corporation pursuant to the Texas Nonprofit Corporation Act, except when those powers are inconsistent with the Act, in which case the Act prevails.
- (3) A development corporation has the power to sell, to lease, to make secured and

²One such example is presented by Bexar Metropolitan Development Corporation, which has been approved for and is currently engaging in the final planning, design, and construction of a surface water treatment plant to be located southwest of San Antonio. Once completed, the plant will be leased to the Bexar Metropolitan Water District, the local governmental entity that formed the development corporation.

LEGAL AND INSTITUTIONAL ISSUES OF THE LAVACA NAVIDAD DESALINATION PROJECT *(Continued)*

unsecured loans, and to sue and be sued.

- (4) A development corporation is a nonprofit, nonmember, nonstock corporation.
- (5) A development corporation has some limited exemption from federal, state, and local taxation (e.g., under state law, development corporations are considered public charities within the tax exemption of Article 8, Section 2 of the Texas Constitution).
- (6) A development corporation and its board of directors are subject to Open Meetings and Open Records Acts.
- (7) A development corporation and its directors and employees are not liable for damages arising out of the performance of governmental functions of the corporation. Development corporation is a "governmental entity" for purposes of the Texas Tort Claims Act. A development corporation generally has no power to own or operate any project as a business entity other than as a lessor, seller, or lender. The "user" (defined as an individual, partnership, corporation, or any other private entity, whether organized for profit or not for profit, or a city, county, district, or any other political subdivision, public entity, or agency of the state, or federal government) pursuant to any lease, sale, or loan agreement relating to a project shall be considered the owner for purposes of the application of any ad valorem, sales use taxes, or any other taxes.
- (8) A development corporation has the power to expend proceeds of the economic development sales tax for purposes authorized by the Act.
- (9) The development corporation's board of directors (in which all powers of the corporation are vested) consists of any number of directors, not less than three, each of whom is appointed by the governing body of the unit under whose auspices the corporation was created for a term of no more than six years, and each of whom shall be removable by the unit for cause or at will.

A development corporation offers an opportunity for public and private entities participating in the Lavaca Navidad Desalination Project to construct the project using a design-build structure to potentially save time and money.

C. Texas Water Development Board Funding

The desalination project should be eligible for funding from the Water Development Board under its "state participation program," which can fund any project authorized in Chapter 16 of the Water Code in any manner consistent with the constitution and the Water Code. *See* Tex. Water Code Ann. § 17.072(f) - (g) (Vernon 1988 & Supp. 2000). Thus, while many provisions of the Water Code applicable to Water Development Board funding seem to apply only to political subdivisions, the state participation program funding language is much broader, and should apply to development corporations, which are not considered to be political subdivisions.

**LEGAL AND INSTITUTIONAL ISSUES OF THE LAVACA NAVIDAD
DESALINATION PROJECT (Continued)**

D. Permitting Issues

1) Amendment of Water Right to Change Purposes of Uses

Central Power and Light Company (CPL) will have to amend their water rights permit with the TNRCC to include additional purposes of uses, most likely municipal, industrial, and irrigation. Although at this time, the water to be sold to San Antonio should only be used for municipal purposes, it may be prudent to add other potential uses to save having to later amend the permit if plans change. In the application to amend the Certificate of Adjudication, the purpose or purposes of each use shall be stated in definite terms. 30 TEX. ADMIN. CODE § 295.5. If the water is to be used for more than one purpose, the specific amount to be used annually for each purpose shall be clearly set forth. If the application requests authorization to use water for multiple purposes, the application shall expressly state an annual amount of water to be used for the multiple purposes as well as for each purpose of use. If the amount to be consumptively used is less than the amount to be diverted, both the amount to be diverted and the amount to be consumptively used shall be specified.

2) Interbasin Transfer Amendment to Water Right

The water right will also be required to be amended to include the interbasin transfer from the Lavaca Guadalupe Coastal Basin to the San Antonio River Basin under §11.085 of the Texas Water Code. The TNRCC may grant the application for an interbasin transfer only to the extent that:

- (1) the detriments to the basin of origin during the proposed transfer period are less than the benefits to the receiving basin during the proposed transfer period; and
- (2) the applicant for the interbasin transfer has prepared a drought contingency plan and has developed and implemented a water conservation plan that will result in the highest practicable levels of water conservation and efficiency achievable within the jurisdiction of the applicant.

TEX. WATER CODE §11.085(l).

In evaluating the above-listed requirements, the commission shall weigh the effects of the proposed transfer by considering the following criteria:

- (1) the need for the water in the basin of origin and in the proposed receiving basin based on the period for which the water supply is requested, but not to exceed 50 years;
- (2) factors identified in the applicable approved regional water plans which address the following:
 - (A) the availability of feasible and practicable alternative supplies in the receiving basin to the water proposed for transfer;

**LEGAL AND INSTITUTIONAL ISSUES OF THE LAVACA NAVIDAD
DESALINATION PROJECT (Continued)**

- (B) the amount and purposes of use in the receiving basin for which water is needed;
 - (C) proposed methods and efforts by the receiving basin to avoid waste and implement water conservation and drought contingency measures;
 - (D) proposed methods and efforts by the receiving basin to put the water proposed for transfer to beneficial use;
 - (E) the projected economic impact that is reasonably expected to occur in each basin as a result of the transfer; and
 - (F) the projected impacts of the proposed transfer that are reasonably expected to occur on existing water rights, instream uses, water quality, aquatic and riparian habitat; and bays and estuaries that must be assessed.
- (3) proposed mitigation or compensation, if any, to the basin of origin by the applicant;
 - (4) the continued need to use the water for the purposes authorized under the existing permit, certified filing, or certificate of adjudication, if an amendment to an existing water right is sought; and
 - (5) the information required to be submitted by the applicant.

TEX. WATER CODE §11.085(k).

Notice of the interbasin transfer permit amendment shall be mailed and published, as required by the statute. TEX. WATER CODE §11.085(f)-(j). A public meeting shall be conducted by the TNRCC to receive comments in both the basin of origin of the water proposed for transfer and the basin receiving water from the proposed transfer. TEX. WATER CODE §11.085(d). If the application is contested, an evidentiary hearing will be held in accordance with commission rules and applicable state law. TEX. WATER CODE § 11.085(e).

3) Wastewater Discharge Permit Amendments

The wastewater discharge (TPDES) permit will have to be amended to add the reject water from the RO Plant to the list of industrial wastes that will be discharged. The issue will be if that amendment will be a major amendment which could possibly lead to a contested case hearing or a minor amendment which is only noticed for public comment without the opportunity for a hearing. TEX. WATER CODE §26.028.

The TNRCC may consider the addition of waste to be discharged as a minor amendment if they decide that the amendment will maintain the permitted quality or method of disposal of waste and if there is not significant increase of the quantity of waste nor a material change in the pattern or place of discharge. 30 TEX. ADMIN. CODE §305.62. A minor amendment includes any change to

**LEGAL AND INSTITUTIONAL ISSUES OF THE LAVACA NAVIDAD
DESALINATION PROJECT (Continued)**

a permit that will not cause or relax a standard or criterion which may result in a potential deterioration of quality of water in the state. *Id.* An argument could be made in favor of a minor amendment that the new discharge would remain within the current flow and effluent limitations and use the same outfalls, therefore, the permitted quality and method of waste disposal would be maintained, there would not be an increase in the quantity of discharge, and the pattern or place of discharge would remain the same. However, the TNRCC may view the increased concentration of the discharge as materially changing the quality or pattern of the discharge and classify it as a major amendment. If that is the case, it could be argued that by decreasing the volume of the discharge, but increasing the concentrations in that smaller discharge, the total loading of solids would not be greater, and therefore, no material change would occur.

If there are solids that cannot be disposed of through the wastewater discharge, it may be possible to process, dispose of, or store the industrial solid waste without obtaining a permit, if the waste is nonhazardous. To fall under this permit exemption, the waste must be processed, disposed of, or stored on property owned or otherwise effectively controlled by the owner or operator of the industrial plant from which the waste is produced and the waste must not be commingled with waste from any other source. 30 TEX. ADMIN. CODE §335.2(d)(1),(2). "Other source" does not include waste from other industrial plants owned by the same person. *Id.* For the processing and disposal exemption, the property must be within 50 miles of the plant or operation. 30 TEX. ADMIN. CODE §335.2(d)(1).

If it is not possible to store, process, or dispose of the nonhazardous industrial solid waste on the plant's property, then a permit from the TNRCC is required. 30 TEX. ADMIN. CODE §335.2(a). If the waste is hazardous, a permit would also be required. *Id.*

4) Section 404 Permit / 401 Certification

A Section 404 permit from the U. S. Army Corps of Engineers will be required prior to constructing the pipe line for the discharge of dredge or fill material into waters of the U. S., including wetlands. The TNRCC will conduct a 401 certification review of the 404 permit application.

The authority for state water quality certification reviews is Section 401 of the federal Clean Water Act. The certification program was established because Congress recognized states' right to protect their water resources, and check federally authorized activities that would have unacceptable adverse impacts to state water quality. The criteria for the application, processing, and review of water quality certifications are found under Chapter 279 of the TNRCC rules.

Activities in wetlands are regulated because wetlands provide many important functions critical to human health and safety and the environment. They perform nutrient and toxicant removal, transformation and retention, sediment retention, groundwater recharge, shoreline stabilization,

LEGAL AND INSTITUTIONAL ISSUES OF THE LAVACA NAVIDAD DESALINATION PROJECT *(Continued)*

floodgate storage, and provide habitat for wetland dependent species.

Application Requirements

The application process generally begins with the Corps, ideally with a pre-application meeting that can be requested by the applicant. While not required, such meetings give applicants an opportunity to discuss their project with federal and state regulatory staff and receive technical assistance. The Section 404 permit application is filed with the Corps district office who has jurisdiction over the activity. The applicant should also complete a TNRCC 401 certification questionnaire and return it to the commission.

Following the filing with the Corps of an administratively complete application, the Corps issues a joint (TNRCC/Corps) public notice. The notice informs the public and other state and federal agencies of the proposed activity, and solicits public comment (generally for a period of 30 days). A public hearing may also be requested during the public comment period.

The application is reviewed by TNRCC staff, who determine whether the proposed activity will result in a violation of state water quality standards. The final certification decision will be to: grant, grant with conditions, deny, or waive certification. A permit is certified if the state determines that the activity will not violate water quality standards. If certification is denied by TNRCC, the Section 404 permit cannot be issued by the Corps. If TNRCC imposes conditions on a certification, the conditions become part of the permit. Following receipt of a 401 certification decision, the Corps determines whether or not to issue the Section 404 permit.

Technical Review

The Commission reviews projects that will result in a discharge to waters in the state (including wetlands) to determine whether they will comply with state surface water quality standards. One provision of the standards that is particularly important to wetlands is the antidegradation policy. This policy requires the protection of water quality necessary to maintain existing and designated uses of waters in the state. TNRCC rules do not allow discharges into wetlands if there is a practicable alternative that would have less adverse impact on the aquatic ecosystem. Projects that are not "water dependent" are presumed to have practicable alternatives, unless clearly demonstrated otherwise by the applicant.

A technical review is conducted to determine whether the antidegradation policy is being met by following a "mitigation sequence" that requires (1) all adverse impacts be avoided to the maximum extent practicable, (2) minimization of remaining unavoidable impacts, and (3) appropriate compensatory mitigation provided for all impacts remaining after avoidance and minimization.

**LEGAL AND INSTITUTIONAL ISSUES OF THE LAVACA NAVIDAD
DESALINATION PROJECT (Continued)**

If compensatory mitigation will be necessary to offset unavoidable adverse impacts to wetlands, the compensation should replace all wetland functions that will be lost as a result of the project. The ratio of units of wetlands required as compensation to units of wetlands lost are set according to the unique circumstances of each case. Generally, the Commission prefers wetlands restoration over enhancement, creation, or preservation; and on-site and in-kind mitigation over off-site and out-of-kind mitigation.

5) Texas Coastal Management Program

Under 30 TEX. ADMIN. CODE §281.45, the proposed changes in CPL's water permit may adversely affect a coastal natural resource area, and therefore, the amendments must be consistent with the goals and policies of the Texas Coastal Management Program. The executive director of the TNRCC shall review the application for consistency with the Coastal Management Program and provide a summary of such analysis and other statements in the draft permit and technical summary. 30 TEX. ADMIN. CODE §281.41.

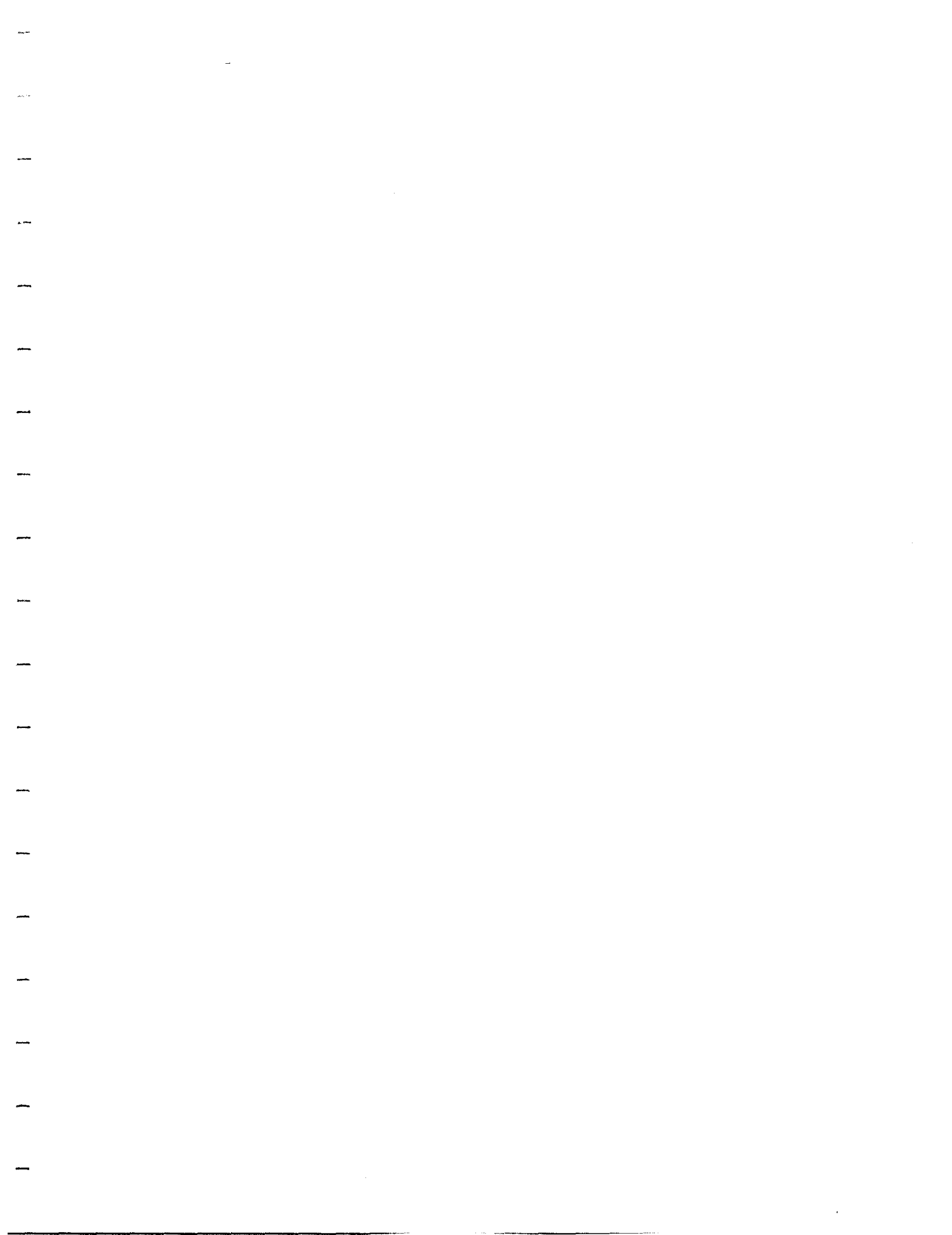

PERMITTING ISSUES

I. Amendment of Water Right to Change of Ownership and Purposes of Uses.

CSW will have to amend its water rights permit to recognize the ownership of project sponsors and to include additional purposes of use, most likely municipal, industrial, and irrigation. Although at this time, the water to be sold to San Antonio should only be used for municipal purposes, it would be prudent to add other potential uses to add flexibility and avoid the necessity of later needing amend the permit if uses are not purely municipal. In the application to amend the Certificate of Adjudication, the purpose or purposes of each use should be stated in definite terms. 30 TEX. ADMIN. CODE § 295.5. If the application requests authorization to use water for multiple purposes, the application must expressly state an annual amount of water to be used for the multiple purposes as well as for each purpose of use. If the amount to be consumptively used is less than the amount to be diverted, both the amount to be diverted and the amount to be consumptively used should be specified.

II. Interbasin Transfer Amendment to Water Right.

The water right will need to authorize the interbasin transfer from the Lavaca Guadalupe Coastal Basin to the San Antonio River Basin under §11.085 of the Texas Water Code. The TNRCC may grant the application for an interbasin transfer only to the extent that:

1. the detriments to the basin of origin during the proposed transfer period are less than the benefits to the receiving basin during the proposed transfer period; and
2. the applicant for the interbasin transfer has prepared a drought contingency plan and has developed and implemented a water conservation plan that will result in the highest practicable levels of water conservation and efficiency achievable within the jurisdiction of the applicant.

TEX. WATER CODE §11.085(1).

In evaluating the above-listed requirements, the commission must weigh the effects of the proposed transfer by considering the following criteria:

- (a) the need for the water in the basin of origin and in the proposed receiving basin based on the period for which the water supply is requested, but not to exceed 50 years;
- (b) factors identified in the applicable approved regional water plans which address the following:
 - (1) the availability of feasible and practicable alternative supplies in the receiving basin to the water proposed for transfer;

- (2) the amount and purposes of use in the receiving basin for which water is needed;
 - (3) proposed methods and efforts by the receiving basin to avoid waste and implement water conservation and drought contingency measures;
 - (4) proposed methods and efforts by the receiving basin to put the water proposed for transfer to beneficial use;
 - (5) the projected economic impact that is reasonably expected to occur in each basin as a result of the transfer; and
 - (6) the projected impacts of the proposed transfer that are reasonably expected to occur on existing water rights, instream uses, water quality, aquatic and riparian habitat; and bays and estuaries that must be assessed....
- (c) proposed mitigation or compensation, if any, to the basin of origin by the applicant;
 - (d) the continued need to use the water for the purposes authorized under the existing permit, certified filing, or certificate of adjudication, if an amendment to an existing water right is sought; and
 - (e) the information required to be submitted by the applicant.

TEX. WATER CODE §11.085(k).

Notice of the interbasin transfer permit amendment shall be mailed and published, as required by the statute. TEX. WATER CODE §11.085(f)-(j). A public meeting shall be conducted by the TNRCC to receive comments in both the basin of origin of the water proposed for transfer and the basin receiving water from the proposed transfer. TEX. WATER CODE §11.085(d). If the application is contested, an evidentiary hearing will be held in accordance with commission rules and applicable state law. TEX. WATER CODE § 11.085(e).

Application of SB 1's rigorous interbasin transfer requirements to a transfer of salt water from a coastal bay serves little purpose, as the underlying policy of protecting basin of origin water supply interests is completely inapplicable. The saline water supply is not limited and the use would not effect in-basin water rights or water supplies. Nevertheless, without a statutory or regulatory amendment, project sponsors will need to satisfy all interbasin transfer requirements.

III. Wastewater Discharge Permit Amendments.

The wastewater discharge (TPDES) permit will need to be amended to add the reject water from the RO Plant to the list of industrial wastes being discharged. Whether the amendment will be a *major amendment* which could possibly lead to a contested case hearing or a *minor amendment* which is only noticed for public comment without the opportunity for a hearing. TEX. WATER CODE §26.028, is not certain.

The TNRCC may consider the modification of the waste discharge as a minor amendment if it concludes that the amendment will maintain the permitted quality and method of disposal of waste, and if there is no significant increase of the quantity in waste nor a material change in the pattern or place of discharge. 30 TEX. ADMIN. CODE §305.62. A minor amendment includes any change to a permit that will not cause or relax a standard or criterion which may result in a potential deterioration of quality of water in the state. *Id.* If the new discharge can be made within the current flow and effluent limitations, at the same outfalls, it should be a minor amendment.

The total load of pollutants will not change as a result of the desalination operation, but the concentration of pollutants will increase because of the removal of desalinated water. Whether TNRCC will view the increased concentration of the discharge as materially changing the quality or pattern of the discharge and classify it as a major amendment, is uncertain.

If pretreatment solids cannot be disposed of through the wastewater discharge, it is possible to process, dispose of, or store non-hazardous industrial solid waste without obtaining a permit. To fall under this permit exemption, the waste must be processed, disposed of, or stored on property owned or otherwise effectively controlled by the owner or operator of the industrial plant from which the waste is produced and the waste must not be commingled with waste from any other source. 30 TEX. ADMIN. CODE §335.2(d)(1),(2). "Other source" does not include waste from other industrial plants owned by the same person. *Id.* For the processing and disposal exemption, the property must be within 50 miles of the plant or operation. 30 TEX. ADMIN. CODE §335.2(d)(1).

If it is not possible to store, process, or dispose of the nonhazardous industrial solid waste on the plant's property, then disposal at a permitted facility will be necessary. 30 TEX. ADMIN. CODE §335.2(a). If the waste is hazardous, disposal at a hazardous waste disposal facility will likely be required.

IV. Section 404 Permit / 401 Certification.

A Section 404 permit from the U. S. Army Corps of Engineers will be required for construction of any new discharge pipeline to the bay or gulf. As part of its review, TNRCC will conduct a 401 certification review of the 404 permit application.

The authority for state water quality certification reviews is Section 401 of the federal Clean Water Act. The certification program was established because Congress recognized states' right to protect their water resources, and check federally authorized activities that would have unacceptable adverse impacts to state water quality. The criteria for the application, processing, and review of water quality certifications are found under Chapter 279 of the TNRCC rules.

V. Texas Coastal Management Program.

Under 30 TEX. ADMIN. CODE §281.45, the proposed changes in CSW's water permit may adversely affect a coastal natural resource area, and therefore, the amendments must be consistent with the goals and policies of the Texas Coastal Management Program. The executive director of the TNRCC shall review the application for consistency with the Coastal Management Program and provide a summary of such analysis and other statements in the draft permit and technical summary. 30 TEX. ADMIN. CODE §281.41.

6.6.5

Examine alternative institutional structures for the implementation of a water development and delivery system, and the cost implications of those alternatives.

a. Evaluate the Public/Private Partnership of LNRA/TWDB/SAWS/Bexar Met/Corpus Christi/Private Entities

Introduction

The use of Public/Private Partnerships in the privatization of water and wastewater projects has in recent years become less the exception and more of the norm. This alternative has become more generally accepted as a viable and cost effective approach for a governmental entity to use when entering into a long-term agreement with a private firm—one in which the project risk is substantially transferred to the private partner.

There are many forms of Public/Private Partnerships and we feel that the one which offers the best value to the LNRA is the design/build/operate (DBO) approach.

Because of the fact that professional services cannot be competitively bid under State of Texas statutes, the DBO approach, undertaken by a not-for-profit Local Government Corporation (LGC), makes a Public/Private Partnership a viable alternative. In addition, this approach will capture all of the benefits traditionally associated with privatized DBO projects.

The approach outlined above has been used in the State of Texas, and has been proven successful. Some examples include the Bexar Met water project in the San Antonio area and the sports stadium in the Houston area.

USFilter Operating Services, Inc. (USFOS) has also implemented public/private-partnering approaches in Texas for communities such as the City of Freeport. In 1994 the City was ordered by the State to upgrade its 50-year-old wastewater plant. USFOS was contracted to upgrade, operate, maintain and manage the water and sewer systems. Under the terms of its agreement with the Freeport, USFOS arranged for the financing and performed the design and startup of \$2.5 million in improvements to the City's wastewater treatment plant in time to meet the terms of the State consent order. In terms of the project financing, USFOS worked with a third party to secure low-cost, tax-exempt financing through no-vote-required revenue bonds.

Through contract operations, maintenance and management of the wastewater facilities, USFOS is saving the City nearly \$120,000 annually. The firm also saved the City millions of dollars in construction costs by engaging an affiliate engineering company to obtain permits, design the improvements and bid the construction under State procurement laws.

Public/Private Partnerships are generally considered beneficial when a local entity is seeking to get the best company for the least cost of service/delivery of product. Additionally, these

types of partnerships allow the local entity or owner to have the partner assume the risk, to guarantee the performance of the facilities/systems constructed, to assure compliance with all applicable regulatory requirements, and to design and construct upgrades of systems/facilities using state-of-the-art equipment and technologies.

To accomplish the objectives of the Public/Private Partnership for the LNRA, USFOS recommends forming an LGC under the provisions of the Texas Transportation Code; this entity would finance and own the project.

Financing Plan

The recommended plan that will be used to implement the Public/Private Partnership with the LNRA will be one that is designed to provide the most benefits, while at the same time complying with the regulatory requirements of the State of Texas. USFOS has made a preliminary analysis of the financing options available to the LNRA as it considers the construction of the desalination project. This financing plan contains a brief analysis of key assumptions and factors that are have addressed in this plan.

Recognizing the dynamic conditions that will be involved in the construction of the desalination plant, USFOS has included some optional enhancements to our basic structure; these enhancements offer potential benefits, depending upon market conditions at the time that the financing plan is implemented. Additionally, USFOS has included a brief description of some of the alternative financing strategies that were considered in developing this plan and a description of the reason each of these alternatives was deemed less desirable than the recommended approach for the plant financing.

Assumptions. USFOS considered a myriad of factors when developing this financing structure for the proposed desalination plant. Many of the factors included key assumptions regarding the intentions of the LNRA and other parties interested in the construction of the proposed desalination facility. The most critical of these assumptions are:

1. The LNRA desires to maintain strategic control of the plant and its existing water rights, and
2. In the context of Assumption 1, above, the LNRA desires to achieve the lowest cost of financing, resulting in the lowest operational costs for the plant, and ultimately optimally priced water rates for the desalination plant's potential customers.

Additionally, USFOS has assumed that the LNRA strongly desires to structure a finance strategy that allows it to essentially construct the plant using an "off balance sheet" approach. The prime motivations for using such an approach are two-fold:

- 1) The fact that this plant will represent a substantial investment to construct, and the rate covenants governing the issuance of the LNRA's water and sewer revenue bonds, and
- 2) The LNRA may make use of the design-build provisions of the procurement procedures to expedite the construction of the facility. With regard to item 1 above, should the LNRA attempt to issue bonds under its existing covenants, all new debt service would require

rate increases sufficient to cover the existing and additional debt service at 1.2 times the debt service of senior lien obligations and 1.1 times the debt service for the combined junior and senior lien obligations.

Recommended Financing Structure

Our recommended financing plan assumes the LNRA's sponsorship in the creation of an LGC to oversee the construction, act as owner, and oversee operations of the plant. This LGC, endowed with the capacity to issue tax-exempt indebtedness, would issue high quality tax-exempt debt to finance the various components of the desalination plant and its related transmission system. Later in this section, our response contains a detailed description of the steps required to establish and maintain this LGC. The LGC's capability to access the tax-exempt markets is critical to achieving the lowest cost of financing for the plant. USFOS' analysis indicates that no other financing mechanism can achieve the optimal results afforded through this financing vehicle.

To achieve a cost of financing which will make the plant economically attractive to potential rate-payers, it is essential that the LGC and its bonds be structured so as to provide the most attractive terms for potential investors. In this regard the single most important credit issue to be considered by the rating agencies, credit enhancement firms, and the investing community, will be the form and extent of the contracts between the LGC and its customers, the public water retailers. These contracts should be in place prior to seeking financing. The optimal structure of these contracts would be for the LGC to secure "Take-or-Pay"¹ contracts with well-rated public distributors and retailers of water, with the large water needs. A contractual relationship with the interested parties prior to the issuance of the bonds will be a vital addition to the credit of the program from both a perception of regional acceptance of the plant and as a substantial customer of the facility. It should be noted that though the LNRA and the vested interested parties represent the largest potential customers for the plant's output, the success of the plant can be greatly augmented by the addition of other customers in the region.

USFOS is confident that, given the negotiation of suitable contracts between the LGC and other interested parties, an investment grade quality credit can be achieved for the LGC's debt. This assertion is made in the context of the contracts as discussed above assure a base level of output. All of this leads USFOS to conclude that the plant has a substantial potential customer base in the region and that potential customers will be highly incentivized to utilize the plant's output. Additionally, upon achieving an investment grade credit rating, the LGC will have no trouble finding exceptionally priced credit enhancement such that the bonds can be sold with a AAA/Aaa rating, further reducing the cost of financing the project construction.

Structure Considerations. USFOS' recommended approach for constructing the desalination plant is a staged approach. As contracts are negotiated between customers and the LGC, incremental increases of capacity can be constructed to address potential water supply needs.

¹ A "Take-or-Pay" contract implies that the customer agrees to pay for a quantity of water whether the water is actually delivered or not. This form of contract recognizes the value of capacity to deliver over the actual delivery of the contracted product. This is contrasted with a "Take-and-Pay" contract in which the customer agrees to only pay for the quantity of product actually delivered.

The recommended financing scheme will mirror this approach. With each new addition to the transmission system and treatment facilities, new tax-exempt bond issues will be issued to finance construction. This approach significantly reduces the startup and construction risks. It further assists in the early years of operation at which time there is inevitable concern regarding cash flow sufficiency for the fledgling LGC and the plant.

Under Texas law, the term of the bonds may not exceed 40 years, and, generally speaking, a longer term on the bonds will reduce the annual debt service requirements. However, market conditions at the time of issue may dictate flexibility in this aspect of the bond issuance. Analysis by USFOS indicates that 30-year obligations are currently eminently marketable. Dynamic market conditions will require revisiting this aspect at each issuance.

Another key element to the structure of the bonds, including the term of the issues, is the ratio of revenues to debt service. The strength of the contracts and the credit strength of the customer base will have a large impact upon this aspect of the structure of the bond issues. USFOS' analysis indicates that with sufficiently strong contractual relationships, a coverage ratio of between 1.2 and 1.3 times debt service is realistic. Again, the specifics of the contractual relationship between and among the various parties could lower or increase the necessary coverage requirements.

The LGC will be required to provide investors with a contingency reserve in the event of an unexpected shortfall in revenues. This contingency fund is normally referred to as a Debt Service Reserve Fund (DSRF). The specific size of the DSRF is established prior to issuance of the bonds and is dependent upon the recommendations of many constituencies. The ratings agencies and credit enhancement firms will provide input in this regard. Additionally, the Section 148 of the Internal Revenue Code provides guidance as to the allowable sizes for fully funded, "reasonably required reserve funds". The Section 148 guidelines provide that a reasonably sized reserve fund requirement may be sized to the lesser of: 10% of the stated principal amount of the issue, the maximum annual principal and interest requirements on the issue, or 125% of the average annual principal and interest requirements on the issue. With the last two options being the most likely results. It is recommended that the LGC satisfy this reserve requirement with a Surety Policy.

It is possible to satisfy this requirement with proceeds from the tax-exempt bond issues. However, factors such as: 1) the substantial amount of bond proceeds required to fully fund the DSRF, 2) the continued obligation to manage the funds assets, and 3) the limit on the allowed investment return on the asset pool to the arbitrage yield on the tax-exempt bonds combine to lead USFOS to recommend the surety policy approach. Additionally, it has been the trend over the last several years for sophisticated, revenue issuers to migrate to the surety policy approach, including the major airport systems in Texas.

With regard to the costs of issuance, USFOS anticipates the normal and customary ranges for similar quality bonds. Fees for underwriter services, legal service, and various fixed costs should amount to no more that 1-2% of the total issue size for each bond issue. Credit enhancement fees are anticipated to be in the range of .5 to 1.2% of total debt service. Our estimate is that the surety policy premiums should range between 2 to 3.5% of the size of the commitment. All of these estimates are dependent upon the underlying credit quality

ultimately realized in the structuring of the LGC, key aspects of the financing structure, and prevailing market conditions at pricing.

Other areas of consideration in structuring the finance plan include the optimization of the investment of bond proceeds until spent on the project. The reserve fund, discussed above, is potentially a significant destination of bond proceeds; however, the single largest deposit of bond proceeds will be the construction fund. In light of this, it is absolutely required that the LGC optimize the investment return on this asset. Generally speaking, issuers are limited to the "Arbitrage Yield" on the invested proceeds of tax-exempt bonds. However, there is an often overlooked loophole in Section 148 which allows an issuer to retain earnings in excess of the Arbitrage Yield on construction funds in the event that the proceeds, and all income from the investment of those proceeds, are spent according to schedule: 10% within 6 months, 45% within 1 year, 75% within 18 months, and 100% within 2 years.

Currently, this strategy could be very beneficial to an issuer. The Treasury yield curve is inverted resulting in short-term investments actually having higher yields than longer-term securities. This situation, in conjunction with the 2-year exception above, offers tax-exempt issuers an excellent opportunity to reduce borrowing requirements by generating and retaining substantial arbitrage income in the construction fund. With an investment strategy for the construction fund making use of guaranteed investment contracts or interest rate swap arrangements on the asset pool, USFOS can assist the LGC in maximizing and retaining any potential earnings on the construction fund deposit. Market conditions are dynamic, and this strategy may not result in an advantage should the yield curve return to a more typical configuration.

Adaptation to the Recommended Structure. An adaptation to the basic structure that USFOS is prepared to make available to the LNRA is the potential for USFOS to provide capital for the project. A mechanism by which USFOS could participate in the financing of the proposed desalination project would be via a senior lien/subordinate lien bond structure. Under such a structure, the LGC would issue two series of tax-exempt bonds: 1) a large, senior lien, tax-exempt series which would finance the bulk of the project, and 2) a smaller subordinate (third lien), tax-exempt series which would be privately placed with USFOS.

The senior lien series would have first priority to revenues for repayment. The subordinate lien would naturally have a lower credit value, and as a result higher return. However, as a purchaser of this bond, and having a vested interest in the success of the plant, USFOS would be willing to purchase a bond with structures that would be beneficial to the LGC, particularly during the early years of start-up. Bond structures which may offer potential benefit to the LGC's financial performance could include Capital Appreciation Bonds (CABs) or "Gainer Bonds," which pay no coupon interest until a specified date, at which time the bonds revert to a coupon payment.

This two-tier financing structure would provide the LGC the ability to finance the plant with tax-exempt debt, attain a favorable capital structure, and retain a motivated partner. For USFOS, this structure would offer the promise of an excellent investment return in the out years, and the goodwill of the LGC and LNRA by demonstrating a willingness to participate meaningfully in the financial success of the operations.

Other Structuring Concepts

Variable Rate Debt. Several other options are available to the LNRA and the LGC in considering a finance plan for the construction of the desalination plant. One such option is the utilization of floating rate debt during the construction period. Variable rate debt offers the opportunity of considerably reducing interest costs on bonds during the construction period. In conjunction with the 2-year spending exemption, variable rate debt has the potential for significant savings to the LGC and the LNRA.

Variable rate debt obligations can be created in a variety of ways. Variable rate demand bonds (VRDBs) are such a product type. Given the extended nature of the construction program and the size of the project, as well as the involvement of the LNRA, a tax-exempt commercial paper (TECP) program could also be an excellent and flexible source of variable rate exposure and construction proceeds. In addition, the LGC could proceed with issuing long-term fixed rate bonds and immediately enter into a fixed-to-floating rate swap agreement. This swap concept would allow the LGC to take advantage of favorable long-term market conditions at the time of issuance, while providing variable rate interest levels during the construction period.

Another alternative would be for USFOS to construct the plant, taking all construction and interim financing risk, and, at the completion of construction, sell the completed plant to the LGC. Another opportunity that has just recently become available is to use the Texas Water Development Board's newly created Clean Drinking Water State Revolving Fund program. This program, as it develops larger capacity, may offer the opportunity to finance at least a portion of the desalination plant with below-market financing. It is designed to leverage subsidies from the Federal government through the Clean Drinking Water Act, to assist municipalities with the construction of water production facilities.

Finally, a variety of products exist to augment the traditional bond structure. Earlier in this section the concept of a fixed-to-floating rate swap during the construction period was presented as a mechanism by which to achieve an advantage through floating rate exposure. This strategy may also be employed in reverse. That is, the LGC could initially issue variable rate debt to finance the construction of the plant. Once the plant is completed, the LGC could maintain the variable rate debt and attain a long-term fixed rate synthetically, by entering into a variable-to-fixed interest rate swap. USFOS would assist the LGC in determining the optimal strategy for this approach. It is rather common that the synthetic fixed rate approach can achieve a lower cost of financing than traditional fixed rate bonds. This strategy could also incorporate a forward delivery swap agreement at the time the variable rate bonds are issued. This forward delivery arrangement would provide the LGC with a known, long-term rate once construction is completed, thereby eliminating interest rate risk on the long-term fix out of the variable rate bonds.

Other Financing Structures Considered

In the course of arriving at the recommended financing structure presented above, USFOS considered a myriad of financing alternatives, as discussed in the paragraphs that follow.

Private Equity Investment. The concept for considering equity participation of private parties is to provide private investors with the opportunity to enjoy the potential success of the plant operations, particularly in the out years. For the LNRA, this concept offers the opportunity to reduce the startup and construction risks of the plant. Additionally, equity participation could be offered as incentives to private parties in compensation for assistance in marketing the plant and its water output.

One concept was to investigate the potential for an equity or partnership relationship between the LNRA, USFOS, and other interested parties. One example explored by USFOS was the model established by Reliant Energy and several public power entities at the South Texas Nuclear Project. In this example an LGC was established with each partner responsible for providing its own financing for its share of the total construction budget by whatever means were available to each partner. Public issuers accessed the tax-exempt markets and private partners made use of their corporate financing resources to generate funds. Each partner is individually responsible for financing its share of the project. The most significant aspect of this model, is the requirement that each partner take its share of output from the plant.

However, this business model breaks down with the requirement that each partner accept its share of the plant output. USFOS is not interested in the desalination plant output per se. US Filter's expertise is in the construction and management of water treatment facilities, not wholesaling water.

Regulated Utility Approach. USFOS also investigated the potential of operating the plant as private enterprise. Under this concept, USFOS could be granted a franchise to operate the plant and either purchase or lease the water rights from the LNRA or purchase inlet water from the LNRA. Alternatively, a corporation could be established to own and operate the plant.

In this model, the LNRA would own 51% of the corporation with private investors owning 49%. This structure would allow a smooth transition of owners as parties needed to join or exit the operations by merely selling or buying the stock of the corporation. This model is, in some respects, similar to business arrangements that have been used with other clients around the world including Paris, Berlin, and Honolulu.

In considering this model, USFOS quickly determined that it would severely hamper the project's ability to access tax-exempt markets. Under federal tax regulations, this type of business arrangement falls into the category of Industrial Development Bonds (IDB). Issuers of this class of bond do have the ability to access the tax-exempt markets, but the Federal government limits the amounts of these bonds by establishing a maximum amount of such bonds that may be issued each year. This limit is referred to as the Volume Cap and once established is allocated to each of the states. Each of the states is then permitted the freedom to grant the issuance of IDBs up to the amount of its allocated volume cap. In the State of Texas, the class of IDB that would fit the model, as described here, is limited to a maximum of \$25 million per year, subject to a lottery system for subscribers. Anecdotal evidence abounds to suggest that the probability of financing a significant amount of the project with IDBs is highly unlikely. Given this fact and the reality that tax-exempt bonds are the least-cost financing vehicles, USFOS chose to not recommend this structure.

a.i - Examine cost implications of alternative structures available to design, build, finance and operate the project.

The most attractive and cheapest form of financing is provided through the LGC and tax-exempt financing options. Using this financing approach, the LNRA can engage in a design/build/operate approach while remaining within the provision of the State of Texas regulations governing such projects.

A typical design/build/operate project offers the following benefits:

- ◆ Expedited construction
- ◆ Fixed construction cost with no change orders
- ◆ Economies of scale by drawing from the professional services and equipment resources of the USFilter family of companies
- ◆ Efficiency in facilities operations, maintenance and management
- ◆ Effective personnel management
- ◆ "Just in Time" parts delivery with no warehousing
- ◆ Access to state-of-the-art technologies through the national and international resources of USFOS.

These benefits have been shown, in past design/build/operate projects for public agencies clients, to achieve costs savings in the range of 15 to 30% on an annualized basis when compared to the traditional LNRA owned and operated treatment plants.

a.ii - Evaluate differences in risk and cost savings under selected alternatives.

The risks involved in the design/build/operate approach in comparison to the conventional design/bid/build approach are:

	Design/Build/Operate Approach	Traditional Approach
Plant Design	Risk Assumed	LNRA Risk
Plant Construction	Risk Assumed	LNRA Risk
Change Orders	Risk Assumed	LNRA Risk
Expedited Construction	Completely Managed	Subcontractors
Economies of Scale	Full Benefits	Minimal
Advantages of Vertical Integration	Maximum	Minimum
Performance	Operator Responsibility	LNRA Responsibility

USFOS has in our past work with municipal clients found ways to minimize these risks and achieve additional cost savings that have kept the overall savings in the range of 15 to 30% when compared to the traditional approach.

a.iii - Determine cost sharing options among co-participants and impacts on the cost of water.

USFOS has found that cost sharing opportunities can be found in design/build/operate projects no matter what the form of financing or approach that is used. These cost sharing opportunities result from savings realized through:

- ◆ Discounted power supply costs
- ◆ Sale of finished water (put or pay contracts)
- ◆ Creation of an LGC
- ◆ Provision of a cheap and suitable raw water supply

As demonstrated in the project examples discussed under "b", USFOS has been able to provide these benefits to municipal clients on projects similar to that proposed by the LNRA.

b. Evaluate potential savings available through the use of design/build/operate method for the project.

The potential cost savings that the LNRA will realize by using the design/build/operate approach for your proposed desalination facility project will in large part be determined by the method of financing chosen and the way in which the partnership is formed and the project implemented. In general terms, public agencies have been able to realize cost savings ranging from 15 to 30% using the design/build operate approach when compared to implementing the same project using a more conventional approach.

USFOS is very familiar with municipal project financing and the various types of funding available for water and wastewater projects. Examples of capital improvements directly financed by USFOS through a third parties are provided in Table 1, next page.

In addition, some of these projects are examined in more detail in the paragraphs that follow, to best illustrate the types and level of cost savings and financial benefits that can be realized using these approaches.

In what is believed to be the first of its kind under new IRS regulations, USFOS was awarded a 20-year operations and maintenance contract in October 1997 to manage wastewater treatment facilities for the City of Danbury, Connecticut. The contract was negotiated in a few short months, due in large part to the ability of USFOS to provide internal financing. Under the terms of the partnership contract, USFOS provided the City of Danbury with \$10 million for other infrastructure needs. The City used the \$10 million to close in an existing landfill. As the partnership progresses, the City will realize additional revenues from the development and management of an expanded septage-receiving program. City's rate-payers will benefit from guaranteed performance and new infrastructure while enjoying stable user fees for the next 20 years.

In 1998, USFOS entered into a partnership agreement with the City of Moncton and became the first private company in Canada to deliver a major water treatment project and services to a Canadian municipality. The innovative business structure used for this project set a new precedent in Canadian tax laws resulting in Moncton owning the facility from the day of commissioning (with no up front capital investment required on their part). When compared to a more traditional build-own-operate structure, the City of Moncton will realize tax savings of more than \$250,000 (Canadian) per year for the next 20 years.

In July 1995, USFOS acquired the Franklin Area WWTP (\$6.8 million) and the right to provide wastewater treatment service to Franklin, Germantown and Carlisle, Ohio for 20 years. This asset purchase, financed internally by USFOS, is the nation's first transition of a municipally owned wastewater treatment plant to private ownership and the first USEPA- and OMB-approved transaction under Presidential Executive Order 12803. The asset purchase provided defeasance of existing municipal bonds, net proceeds to be used for infrastructure and tax reduction. The 20-year contract immediately reduced annual wastewater treatment expense by 14%. This project is solely guaranteed by USFOS.

In 1995, USFOS was awarded a 10-year contract to partially finance, design and construct, operate and maintain critical odor control equipment. Under this agreement, USFOS will continue to operate the WWTP, as it has since 1980, and partially finance through internal funds the \$5.5 million in capital improvements. The City pays for the improvements by making progress payments to USFOS during construction and until completion, as well as making some purchases directly. This project is solely guaranteed by USFOS.

As these projects illustrate, USFOS is committed to assisting municipal clients with evaluating and securing the least cost and most appropriate type of financing. They also illustrate that a wide range of implementation alternatives are available, each of which provides differing levels of cost benefits and cost sharing approaches for municipalities that enter into a Public/Private Partnership.